

Crestron Isys® **TPS-3100L**

6.4 Inch Lectern/Wall Mounted Touchpanel

Operations Guide



This document was prepared and written by the Technical Documentation department at:



Crestron Electronics, Inc.  
15 Volvo Drive  
Rockleigh, NJ 07647  
1-888-CRESTRON

# Contents

<b>6.4 Inch Lectern/Wall Mount Touchpanel: Crestron Isys® TPS-3100L</b>	<b>1</b>
Introduction .....	1
Features and Functions .....	1
Specifications .....	3
Physical Description .....	5
Industry Compliance .....	7
Setup .....	7
Network Wiring .....	7
Identity Code .....	9
Configuring the Touchpanel .....	9
Hardware Hookup .....	14
Mounting Options .....	18
Touchpanel Mounting .....	19
Touchpanel Removal .....	20
Recommended Cleaning .....	20
Programming Software .....	20
Programming with the Crestron SystemBuilder .....	22
Programming with SIMPL Windows .....	22
Programming with Crestron VisionTools® Pro-e .....	27
“Quick” Pushbuttons .....	30
Reserved Join Numbers .....	31
MultiByte International Characters .....	32
Uploading and Upgrading .....	33
Communication Settings .....	33
Uploading a SIMPL Windows Program .....	36
Uploading a VT Pro-e Project .....	37
Firmware Upgrade .....	39
Problem Solving .....	41
Troubleshooting .....	41
Further Inquiries .....	42
Future Updates .....	42
Appendix: Configuring the RS-232 Port for Use .....	43
Obtaining Communications .....	43
Configuration Options .....	43
RS-232 Port Configuration .....	43
Software License Agreement .....	45
Return and Warranty Policies .....	47
Merchandise Returns / Repair Service .....	47
CRESTRON Limited Warranty .....	47



# 6.4 Inch Lectern/Wall Mount Touchpanel: Crestron Isys® TPS-3100L

---

## Introduction

### Features and Functions

The TPS-3100L series of touchpanels pack all the power and performance of an Isys panel in a stylish lectern or wall-mount model. Its compact stature makes the TPS-3100L series perfect for the home or boardroom, especially in locations like home theaters, bedrooms, the home office, and podiums.

These touchpanels are available in three colors: almond, black, and white. The suffix 'A', 'B', and 'W' respectively denotes color, i.e. TPS-3100LB is a black unit. For simplicity within this guide, color suffix is omitted.

Featuring a 6.4" active matrix display that provides the finest quality video and graphics available on a screen of its size, the TPS-3100L features the 65,536-color Isys engine which allows all graphics to be displayed with incredible brightness and depth. A light sensor automatically brightens or dims the display with room light for easy viewing.

#### *TPS-3100L Functional Summary*

- 6.4" (16.26 cm) active matrix color display
- 640 x 480 screen resolution
- 16 Bit non-palette graphics, over 64,000 colors
- 8 Mb of Flash & 8 Mb of DRAM memory
- Built-in time-based correction for stable video & graphics
- Balanced/unbalanced, S-video or composite video input; supports NTSC/PAL formats
- Full screen video capability

*(continued on next page)*

*TPS-3100L Functional Summary (Continued)*

- Up to 4,000 digital and 4,000 analog signals; up to 999 serial signals
- Built-in microphone & two speakers (half duplex intercom capable)
- Stores and plays WAV sound files
- Automatic light sensor
- Support for downloadable fonts – proportional<sup>1</sup> and non-proportional
- Foreign language text
- Five pushbuttons that can be programmed for quick access to regularly used functions<sup>2</sup>

1. Proportional fonts: the width of each character differs with the character shape, for example, the letter M is wider than the letter I. All characters in non-proportional fonts are spaced equally.
2. Custom engraved keys can be ordered separately by using the Crestron Engraver Software. Version 2.2.1.2 or later is available from the Downloads | Software Updates section of the Crestron website ([www.crestron.com](http://www.crestron.com)).

Multiple graphics can be displayed on the TPS-3100L without any shift in color depth or quality. The TPS-3100L can display real-time video from any Crestron balanced video distribution product or any unbalanced video, S-video or composite video source.

The TPS-3100L's audio capabilities include mono audio speakers with built-in volume control, a built-in microphone with line-level output for intercom applications (when used with the Crestron C2N-IADS30x24), built-in WAV sound file playback capability, and line-level input from other audio sources.

The TPS-3100L has the ability to transmit touch coordinates when “RS-232 Port for Touch Output” is selected. Currently Telestrator devices are supported on the TPS-3100L. Refer to the “RS-232 Menu” section of “Configuring the Touchpanel” on page 14 and “Appendix: Configuring the RS-232 Port for Use” on page 43 for instructions on selecting this feature.

This touchpanel also features five engraveable pushbuttons. These buttons can be programmed to access regularly used functions. Each button features LED feedback with adjustable brightness to indicate operation.

The TPS-3100L has a “Dynamic range” compression feature. When enabled, the audio amplifier gain is reduced dynamically for loud signal levels, thus eliminating most distortion at the speakers. For quiet audio signals, the gain is not reduced. When “Dynamic range” compression is turned off (default), the audio amplifier gain remains fixed for all signal levels at the given volume setting. Refer to the “Audio Menu” section of “Configuring the Touchpanel” on page 10 for instructions on selecting this feature.

The purpose of the TPS-3100L touchpanel is to provide an economical replacement for multiple controllers or older control panels having a complicated user interface in a Cresnet system with a series of simpler screens each specific to the control problem at hand. Thus, a very large number of functions can be made available to the user without the confusion associated with hardware panels of that complexity. Icons, graphics, and text can dramatically increase any user's comprehension of the control environment. Devices, functions, and control zones are quickly organized and more easily accessed.

## Specifications

The following table provides a summary of specifications for the TPS-3100L touchpanel.

### *Specifications for the TPS-3100L Touchpanel*

SPECIFICATION	DETAILS
Power Requirements	20 Watts (0.83 Amp @ 24 VDC)
Default Net ID	03
Timeout	Adjustable from 0 to 120 minutes (Default = 10 min.)
Signal Join Maximums	4000 Digital, 4000 Analog, 999 Serial
Control System Update Files <sup>1,2,3</sup>	
2-Series Control System	Version C2.V2004.CUZ or later <sup>2</sup>
CEN/CN-TVAV	Version 51130V.UPZ or later <sup>3,4</sup>
CNMSX-AV/PRO	Version 51125X.UPZ or later <sup>3,4</sup>
CNRACKX/-DP	Version 51125W.UPZ or later <sup>3,4</sup>
CNMS, CNRACK, CNLCOMP	Version 3.18.09m, l, c or later or later <sup>3</sup>
ST-CP	Version 4.02.4S.UPZ or later
Audio	<ul style="list-style-type: none"> <li>Balanced (20 kΩ) &amp; unbalanced (10 kΩ) line level mono input through 6-position mini-terminal block connector</li> <li>Maximum input level 2 V<sub>RMS</sub> single ended, 4 V<sub>RMS</sub> differential with internal volume control and two speakers</li> <li>Balanced line level microphone with AGC output via 3-position mini-terminal block connector</li> <li>Microphone Output Impedance: 600 Ohm balanced / 300 Ohm Unbalanced</li> <li>Maximum Microphone Output: 1 V<sub>RMS</sub> single ended, 2 V<sub>RMS</sub> differential</li> <li>Built-in WAV file (8 bit, 8 kHz, mono PCM type) &amp; key click capability<sup>5</sup></li> <li>Speaker amplification: 5 Watts per channel</li> </ul>

*(continued on next page)*

*Specifications for the TPS-3100L Touchpanel (Continued)*

SPECIFICATION	DETAILS
Video	<ul style="list-style-type: none"> <li>• Composite/S-video input through 6-position mini-terminal block connector (Balanced 100 Ω: cable run not to exceed 500 feet (152.4 meters)), or 2-position mini-terminal block connector (Unbalanced 75 Ω: cable run not to exceed 100 feet (30.5 meters)).</li> <li>• Built-in time base correction for stable video and graphics</li> <li>• Video can be displayed full screen or in a window</li> <li>• NTSC and PAL supported</li> <li>• Supports still and full-motion video</li> <li>• Brightness, contrast, hue and saturation adjustments</li> </ul>
Touchpanel Firmware	TPS-3000_4000.v2.006.0956.csf or later
Memory	8MB internal flash memory (7MB for user display lists), 8MB of DRAM
Screen Dimensions	6.4"/16.3 cm diagonal
Screen Viewing Angles:	Y Dir. (X=0°): +40° (from top), -55° (from bottom) X Dir. (Y=0°): +60° (from right), -60° (from left)
Screen Resolution	640 x 480 pixels
Color	16 Bit non-palette graphics with color key video window capability, 65,536 colors
Display Type	Touch-sensitive active matrix color LCD
Enclosure	Metal enclosure with injection-molded plastic faceplate in black, white, or almond.
CPU	63MIPs Coldfire processor running Isys generation firmware
Cresnet	Via 4-position mini-terminal block connector
RS-232	RJ11 connector for console, telestrator, etc. Default settings: 115200, 8 bit, parity none, stop bit 1, XON/XOFF off, RTS/CTS off.
Operating Temperature and Humidity	50° to 113° F (10° to 45° C), 10 to 90% Relative Humidity (non-condensing)
Dimensions and Weight (with faceplate)	Height: 6.06 in (15.38 cm) Width: 8.57 in (21.76 cm) Depth: 2.99 in (7.60 cm) Weight: 2.8 lbs (1.3 kg)
Programmable Pushbuttons	Five with fixed join numbers (numbered 1 to 5). Custom engraved buttons can be ordered separately from Crestron.

1. The latest versions can be obtained from the Downloads | Software Updates section of the Crestron website ([www.crestron.com](http://www.crestron.com)). Refer to NOTE after last footnote.
2. Crestron 2-Series control systems include the AV2 and PRO2. Consult the latest Crestron Product Catalog for a complete list of 2-Series control systems.
3. CNX update files are required for either CNMSX-AV/PRO or CNRACKX/-DP. Filenames for CNX update files have a UPZ extension and ST-CP files are in one EXE or zipped UPZ file. To avoid



- program problems, make certain you are using the update file with the correct suffix letter (e.g., S, V, W, X).
- When loading Crestron VisionTools® Pro-e files or firmware through the RS-232 port of the control system, Viewport may post the "Transfer Failed" message. To ensure successful data transfer, set the baud rate to 38400 (Cresnet speed) or lower.
  - WAV files reside in the touchpanel's Flash memory and will affect the amount of available space for touchpanel screens.

---

**NOTE:** Crestron software and any files on the website are for Authorized Crestron dealers and Crestron Authorized Independent Programmers (CAIP) only. New users may be required to register to obtain access to certain areas of the site (including the FTP site).

---

## Physical Description

The 6.4 inch (16.26 cm) touch sensitive viewing screen is located on the front of the TPS-3100L touchpanel with five engraveable pushbuttons on the side. A faceplate conceals two speakers, a photosensor and a microphone. The electronic hardware is housed in a metal enclosure, with a colored faceplate as shown in the following diagram. All audio, video, RS-232, network, and power connections are made at the rear of the unit.

*TPS-3100L Shown with Optional Engraved Buttons (Unit Ships with Colored Blanks)*



Physical Views of the TPS-3100L Touchpanel (Top, Front, and Side)

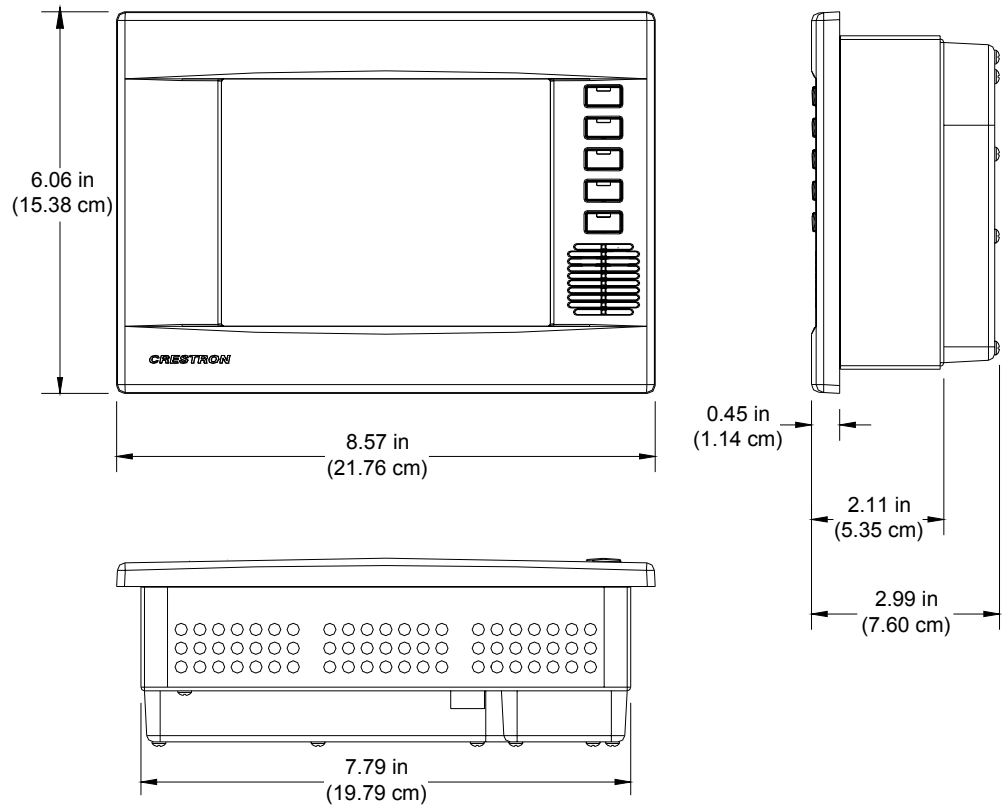

Physical View of the TPS-3100L Touchpanel (Back)

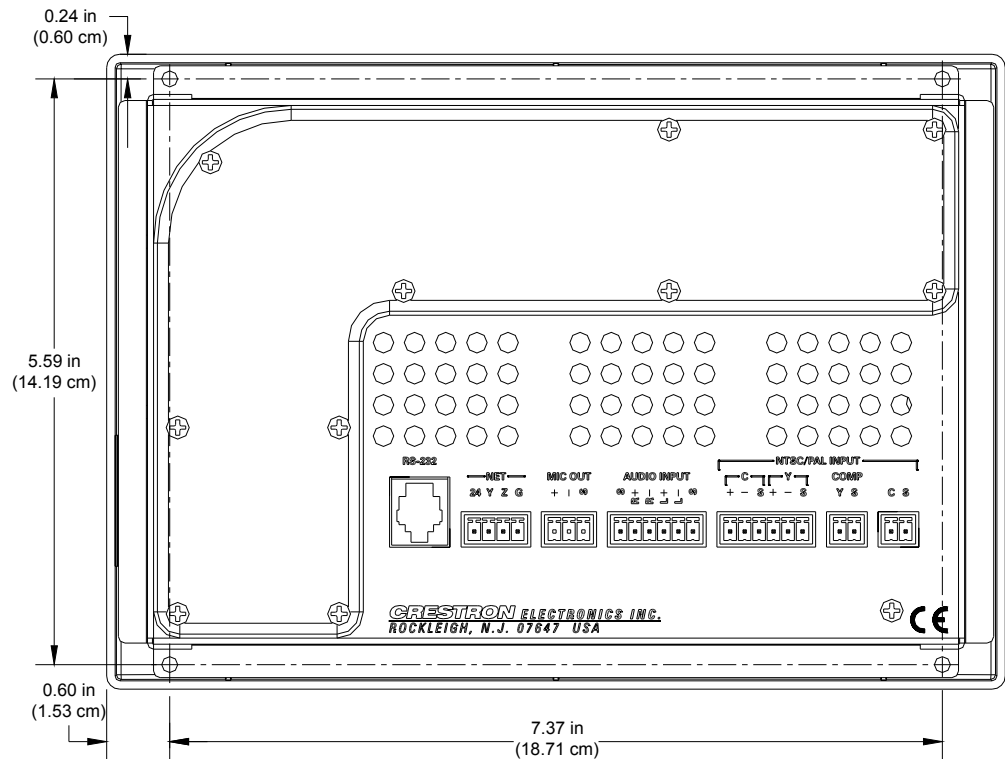

## Industry Compliance

As of the date of manufacture, the TPS-3100L has been tested and found to comply with specifications for CE marking and standards per EMC and Radiocommunications Compliance Labelling (N11785).



---

**NOTE:** This device complies with part 15 of the FCC rules. Operation is subject to the following two conditions: (1) this device may not cause harmful interference, and (2) this device must accept any interference received, including interference that may cause undesired operation.

This equipment has been tested and found to comply with the limits for a Class B digital device, pursuant to part 15 of the FCC Rules. These limits are designed to provide reasonable protection against harmful interference in a residential installation. This equipment generates, uses and can radiate radio frequency energy and, if not installed and used in accordance with the instructions, may cause harmful interference to radio communications. However, there is no guarantee that interference will not occur in a particular installation. If this equipment does cause harmful interference to radio or television reception, which can be determined by turning the equipment off and on, the user is encouraged to try to correct the interference by one or more of the following measures:

- Reorient or relocate the receiving antenna.
  - Increase the separation between the equipment and receiver.
  - Connect the equipment into an outlet on a circuit different from that to which the receiver is connected.
  - Consult the dealer or an experienced radio/TV technician for help.
- 

---

## Setup

### Network Wiring

---

**CAUTION:** Use only Crestron power supplies for Crestron equipment. Failure to do so could cause equipment damage or void the Crestron warranty.

**CAUTION:** Provide sufficient power to the system. Insufficient power can lead to unpredictable results or damage to the equipment. Please use the Crestron Power Calculator ([www.crestron.com/dealer-tech\\_resources/power\\_calculator.asp](http://www.crestron.com/dealer-tech_resources/power_calculator.asp)) to help calculate how much power is needed for the system.

**CAUTION:** Possible equipment damage if miswired.

**NOTE:** When installing network wiring, refer to the latest revision of the wiring diagram(s) appropriate to your specific system configuration, available from the

Downloads | Product Manuals | Wiring Diagrams section of the Crestron website (www.crestron.com).

**NOTE:** Do not power up system until all wiring is verified. Care should be taken to ensure data (Y, Z) and power (24, G) connections are not crossed.

---

When calculating the wire gauge for a particular Cresnet run, the length of the run and the power factor of each Cresnet unit to be connected must be taken into consideration. If Cresnet units are to be daisy-chained on the run, the power factor of each network unit to be daisy-chained must be added together to determine the power factor of the entire chain. The length of the run in feet and the power factor of the run should be used in the following resistance equation to calculate the value on the right side of the equation.

*Resistance Equation*

$$R < \frac{40,000}{L \times PF}$$

Where: R = Resistance (refer to table below). L = Length of run (or chain) in feet. PF = Power factor of entire run (or chain).
---

The required wire gauge should be chosen such that the resistance value is less than the value calculated in the resistance equation. Refer to the table after this paragraph.

*Wire Gauge Values*

RESISTANCE (R)	WIRE GAUGE
4	16
6	18
10	20
15	22
13	Doubled CAT5
8.7	Tripled CAT5

**NOTE:** All network wiring must consist of two twisted pairs. One twisted pair is the +24V conductor and the GND conductor. The other twisted pair is the Y and Z conductors.

**NOTE:** When daisy-chaining Cresnet units, strip the ends of the wires carefully to avoid nicking the conductors. Twist together the ends of the wires that share a pin on the network connector, and tin the twisted connection. Apply solder only to the ends of the twisted wires. Avoid tinning too far up the wires or the end becomes brittle. Insert the tinned connection into the Cresnet connector and tighten the retaining screw. Repeat the procedure for the other three conductors.

**NOTE:** For larger networks (i.e., greater than 28 network devices), it may become necessary to add a Cresnet Hub/Repeater (CNXHUB) to maintain signal quality throughout the network. Also, for networks with lengthy cable runs, it may be necessary to add a Hub/Repeater after only 20 devices.

---

## Identity Code

All equipment and user interfaces within the network require a unique identity code (Net ID). These codes are two-digit hexadecimal numbers ranging from 03 to FE. Refer to “Interface Menu” on page 10 for instructions on setting the unit's Net ID. The Net ID of each unit must match an ID code specified in the SIMPL Windows program. Refer to “Setting the Net ID in Device Settings” on page 23 for details of the SIMPL Windows procedure.

## Configuring the Touchpanel

**NOTE:** The only connection required to configure the touchpanel is power (+24V and Ground). Refer to “Hardware Hookup” on page 14 for details.

### MAIN MENU

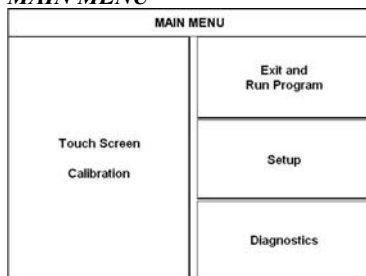

*This menu can also be obtained via digital reserved join number, 17242.*

To configure the unit, it may be necessary to access a series of setup screens prior to viewing run-time screens that are loaded into the touchpanel for normal operation. The MAIN MENU for configuring the touchpanel appears when a finger is held to the touchscreen as power is applied. Remove your finger when the MAIN MENU appears.

**NOTE:** The SETUP MODE can also be accessed through the Viewport Utility if the touchpanel is connected to a control system via Cresnet or to a PC via RS-232 by selecting **Functions | Put Touch Panel into Setup Mode...** from the Viewport menu.

Upon entering SETUP MODE, the MAIN MENU, shown to the left, displays four buttons: **Touch Screen Calibration**, **Exit and Run Program**, **Setup**, and **Diagnostics**.

The **Exit and Run Program** button verifies that all of the setup information has been saved to EEPROM and displays the main page that has been programmed into your system. The remaining buttons on the MAIN MENU open other menus, which are discussed in subsequent paragraphs.

### Calibration Menu

#### CALIBRATION MENU

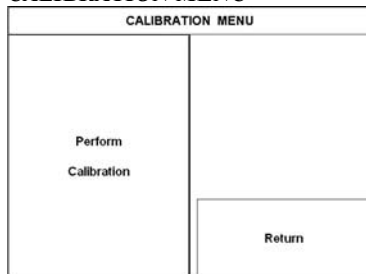

Calibration of the touchscreen is required if the active touch area of a button does not coincide with the button's image. Select the **Touch Screen Calibration** button to display the CALIBRATION MENU, shown to the left. The CALIBRATION MENU offers the choice to initiate calibration with the **Perform Calibration** button or return to the previous screen with the **Return** button. Choose an option by touching the correct button.

If you proceed to calibrate the touchpanel, the screen displays the message “Touch Lower Right” centered on the panel with a cross hair in the lower right corner. Touch the center of the cross hair in the corner of the screen to initiate calibration. Another message, “Touch Lower Left”, appears with a cross hair in the correct corner. Touch the center of the cross hair in the corner of the screen. A final message, “Touch Upper Left”, appears with a cross hair in the correct corner. Touch the center of the cross hair in the corner of the screen to conclude calibration and return to the MAIN MENU.

**NOTE:** When touching the screen during calibration, be as accurate as possible. Use the tip of a capped pen or the eraser end of a pencil. To cancel calibration and return to the CALIBRATION MENU without saving calibration data, create a calibration error by touching the screen in the same spot for each calibration point.

**NOTE:** The touchpanel's calibration routine can also be accessed through the Viewport Utility if the touchpanel is connected to a control system via Cresnet or to a PC via RS-232 by selecting **Functions | Put Touch Panel into Calibration Mode...** from the Viewport menu.

### Setup Menu

#### SETUP MENU

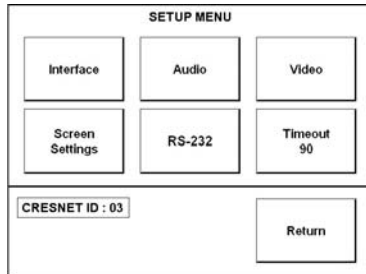

To obtain the SETUP MENU, shown to the left, press the **Setup** button from the MAIN MENU. The SETUP MENU offers a series of buttons, which opens additional menus and displays, which are detailed in subsequent paragraphs. After setup parameters have been set, select the **Return** button to return to the MAIN MENU.

**NOTE:** For convenience, the current CRESNET ID setting is displayed in the lower left corner.

**NOTE:** All touchpanel settings are automatically saved in non-volatile memory.

#### INTERFACE MENU

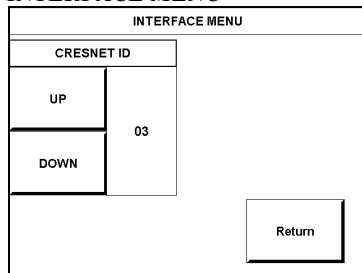

### Interface Menu

The touchpanel communicates with a control system to activate commands or to display feedback from components within the system. The communication interface must be correctly specified or communication will not occur. To set communication parameters select the **Interface** button located on the SETUP MENU and display the INTERFACE MENU, shown to the left.

The Cresnet network identity number (CRESNET ID) is displayed on the INTERFACE MENU. CRESNET ID is a two-digit hexadecimal number. The hexadecimal number can range from 03 to FE and must correspond to the Net ID set in the SIMPL Windows program of the Cresnet system. Matching IDs between the touchpanel and SIMPL Windows program is required if data is to be successfully transferred. The Net ID for the TPS-3100L is factory set to 03. No two devices in the same system can have the same Net ID.

Two buttons adjacent to the hexadecimal display, **UP** and **DOWN**, increase and decrease the CRESNET ID by one, respectively.

Select the **Return** button located on the INTERFACE MENU to accept the changes and return to the SETUP MENU.

#### AUDIO MENU

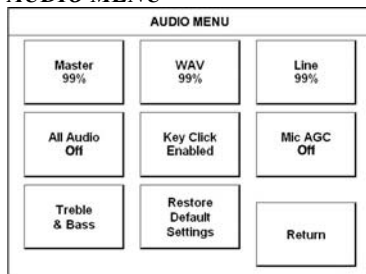

### Audio Menu

Audio is a useful feedback tool and it can be used to enhance a custom interface. To access the AUDIO MENU, shown to the left, press the **Audio** button from the SETUP MENU. The AUDIO MENU offers a series of buttons, which opens additional screens and is detailed in a table after this paragraph. Two of the buttons on the AUDIO MENU perform a function directly. The **Restore Default Settings** button returns all audio parameters to their default settings when the button is selected. After audio parameters have been set, select the **Return** button to return to the SETUP MENU.

*Audio Setup Details*

AUDIO MENU BUTTON <sup>1</sup>	AUDIO SETUP SCREEN	DESCRIPTION <sup>2</sup>
Master 88%	Master Volume	The volume of all audio types (WAV, line, and key click) is affected by the Master Volume control. If the Master Volume control is set to 100%, the volume for any type of audio is at maximum. If the Master Volume is set to 0%, the value of all audio types is overridden and the touchpanel is silent. If Master Volume is a percentage (say 50%), then all audio types can only achieve half their value.
WAV 88% (On)	WAV	Enable WAV files with the <b>WAV On</b> button. <b>WAV Off</b> disables this feature. Adjust the volume with the <b>UP</b> and <b>DOWN</b> buttons. Select the <b>Play WAV File</b> to sample and adjust the volume as a pre-loaded WAV file plays.
Line 88% (On)	Line	Enable line level audio with the <b>Line On</b> button. <b>Line Off</b> disables this feature. Adjust the volume with the <b>UP</b> and <b>DOWN</b> buttons.
All Audio (On)	All Audio Control	All types of audio may be disabled with a single button press. <b>All Audio Off</b> activates global muting. <b>All Audio On</b> enables all audio.
Key Click Enabled (Vol. 83%)	Key Click	<b>Click On</b> enables the key click sound, <b>Click Off</b> disables the key click. Adjust the volume with the <b>UP</b> and <b>DOWN</b> buttons.
Mic AGC On	AGC <sup>3</sup>	The built-in microphone AGC (Automatic Gain Control) is enabled by the <b>Mic Audio AGC On</b> button and disabled with the <b>Mic Audio AGC Off</b> button.
Treble & Bass (49%)	Treble & Bass	Two <b>UP</b> and <b>DOWN</b> buttons allow independent treble and bass adjustment.

1. The button text shown demonstrates the default audio setting for a given button. The items in parenthesis are also default values, but are seen in subsequent screens.
2. Each screen has its own **Return** button to revert to the AUDIO MENU. Selected buttons are shown in red on the touchpanel.
3. AGC is a means of automatically controlling the gain of the amplifier in order to maintain a constant level over a limited range. It does not turn off the microphone.

**NOTE:** If key click is enabled on a touchpanel, each press of the touchpanel results in an audible click. It may be desirable to conceal the key click sound for certain buttons (e.g., if the button triggers playing of a WAV file). Using Crestron VisionTools® Pro-e (VT Pro-e), the panel designer has the option to suppress the key click on a button-by-button basis from the “Button Properties” window. A button must have a page flip or a join number other than “0” assigned for it to click.

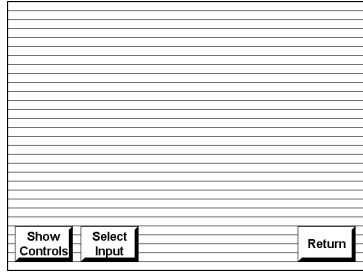
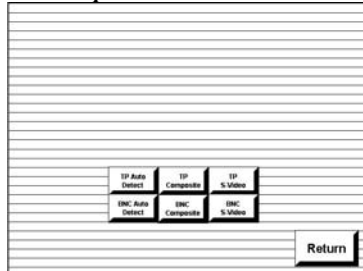
**Video Screen****Select Input Screen****Video Menu**

The TPS-3100L can display balanced and unbalanced composite video and S-video input supporting both NTSC/PAL formats. Select the **Video** button from the SETUP MENU to display the VIDEO screen, shown to the left.

The type of video source signal is specified by selecting **Select Input**. The touchpanel can be configured to auto-detect S-video or composite video signals or can be set to a specific signal type (S-video or composite) from a specific connection. Select the appropriate input mode. Use either the **TP Composite / BNC Composite** or **TP S-Video / BNC S-Video** buttons to manually control the mode. **TP** or **BNC** on the selected button specifies the video input connector. **TP** corresponds to the 6-position mini-terminal block connector (balanced video from a Crestron Video Distribution Switch, Crestron Room Box, etc.) and **BNC** corresponds to the dual 2-position mini-terminal block connectors (unbalanced video from a VCR, DVD, etc.). Use the appropriate **Auto Detect** button for automatic control. The text color of the selected button is red rather than black. Select the desired mode, and select the **Return** button to return to the VIDEO screen.

The **Show Controls** button on the VIDEO screen offers another screen with a series of buttons, each is detailed in the following table. After video parameters have been set, select the **Return** button to return to the SETUP MENU.

**Video Setup Details**

<b>VIDEO SCREEN BUTTONS<sup>1</sup></b>	<b>DESCRIPTION<sup>2</sup></b>
Brightness	<b>UP</b> button increases video image brightness, <b>DOWN</b> button decreases video image brightness.
Contrast	<b>UP</b> button increases video image contrast, <b>DOWN</b> button decreases video image contrast.
Saturation	<b>UP</b> button increases video image saturation, <b>DOWN</b> button decreases video image saturation.
Hue	<b>UP</b> button increases video image hue, <b>DOWN</b> button decreases video image hue.
Still/Motion (toggle)	The <b>Motion</b> setting eliminates the motion artifacts caused by the difference between first and second halves of a video frame field. The <b>Still</b> setting yields a much sharper image, however, motion artifacts may occur if fast moving objects are displayed.
Hide Controls	This button returns the display to the VIDEO screen.
Default	Restores the default settings. When prompted with "Are you sure?" answer <b>YES</b> to restore the default settings. Answer <b>NO</b> to return to the previous screen.
Return	Returns to the SETUP MENU.

1. Video default is 50% for each of the video parameters (brightness, contrast, saturation, and hue).

2. Each screen has its own **Return** button to return to the SETUP MENU.

**NOTE:** A solid blue screen is displayed in the video window if the video signal is not detected or is very weak. Verify that the video source is functioning and properly connected. Balanced video cable runs should not exceed 500 feet (152.4 meters) and unbalanced video cable runs should not exceed 100 feet (30.5 meters). Cable runs in excess of these lengths will weaken the video signal.



**Screen Settings**

**SCREEN SETTINGS**

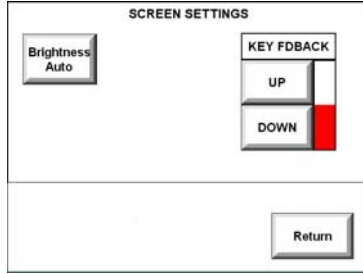

Screen brightness and pushbutton settings may need to be adjusted because of ambient light conditions or personal preference. These screen attributes may be automatically set via programming or be altered manually by selections made from the SCREEN SETTINGS display, shown to the left. Press the **Screen Settings** button from the SETUP MENU to access this screen. To return to the SETUP MENU and save screen settings, select the **Return** button on the SCREEN SETTINGS display. Screen settings are factory set to **Brightness Auto** and 50% **KEY FDBACK** (Key Feedback Lighting). Alterations to brightness are performed on subsequent screens after selecting the **Brightness** button, located in the upper left corner.

The key feedback lighting (the key lighting when a key is engaged) level can be adjusted by pressing **UP** or **DOWN**. Setting the value to zero will disable the lighting.

**SCREEN SETTINGS - BRIGHTNESS**

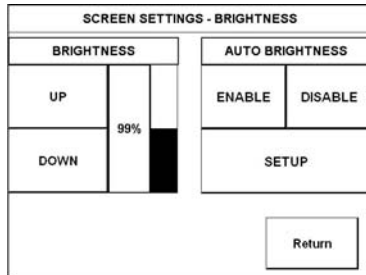

Press the **Brightness** button to open the SCREEN SETTINGS – BRIGHTNESS display. Manual controls are located on the left side and automatic controls are located on the right side. Two buttons, **ENABLE** and **DISABLE**, are used to determine whether the touchpanel brightness is controlled manually or automatically via thresholds. Select the **ENABLE** button for automatic settings. Notice that a ‘net’ covers the manual controls on the left. The **DISABLE** button removes the ‘net’ to permit manual advancements (use the **UP** button) and reductions (use the **DOWN** button) to the screen brightness.

**SCREEN SETTINGS – AUTO BRIGHTNESS THRESHOLD**

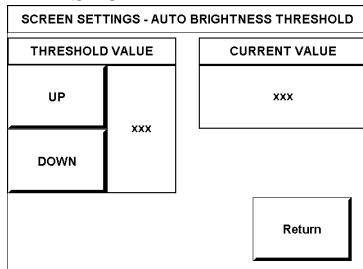

Choose the **SETUP** button on the SCREEN SETTINGS – BRIGHTNESS display to open the SCREEN SETTINGS – AUTO BRIGHTNESS THRESHOLD display, shown to the left. A photosensor on the front panel permits this exclusive light-sensing touchpanel to automatically determine if the amount of light sensed exceeds a set threshold value. This threshold value allows the touchpanel to switch between daytime super bright (high brightness) and evening soft glow (low brightness) automatically. The right side of this display shows the **CURRENT VALUE** as detected by the photosensor. This value, represented by xxx in the illustration, can range from 0% (dark) to 100% (very bright). The **THRESHOLD VALUE** located on the left side of the display needs to be set to automatically adjust brightness. The numerical value, represented by xxx in the illustration, can range from 0% (dark) to 100% (very bright). Use the **UP** and **DOWN** buttons to increase and decrease the **THRESHOLD VALUE**, respectively.

If the **CURRENT VALUE** has exceeded the **THRESHOLD VALUE**, the screen switches to high brightness. When the **CURRENT VALUE** is less than the **THRESHOLD VALUE**, the screen switches to low brightness.

**RS-232 SETTINGS**

BAUDRATE		
110	150	300
600	1200	2400
4800	9600	19200
38400	57600	115200
DATA BITS		
7	8	
PARITY		
None	Odd	Even
STOP BITS		
1	2	

RS-232 Port for Console

RS-232 Port for Touch Output

RS-232 Port for Ext. Touch Input

RTS-CTS On    RTS-CTS Off

XON-XOFF On    XON-XOFF Off

Save and Return

**RS-232 Menu**

The touchpanel allows for four RS-232 communication methods: console (i.e. loading programs), touch output (communication of touch coordinates to an external device) or external touch screen input.

For convenience, the RS-232 Menu also permits the selection of the RS-232 communication options, RTS-CTS On or Off, XON-XOFF On or Off, Baud Rate, Data Bits, Parity, and Stop Bits.

Touch the communication option to select communication parameters and then select **Save and Return** to save the RS-232 settings and return to the SETUP MENU.

Default settings are: 115200 baud, 8 bit, parity none, stop bit 1, XON/XOFF off, RTS/CTS off.

**Timeout Settings****TIMEOUT SETTINGS**

STANDBY	
UP	90
DOWN	
Return	

The touchpanel display can be automatically turned off (standby mode) when not in active use. Select the **Timeout** button on the SETUP MENU to reveal the TIMEOUT SETTINGS display, shown to the left. This setting automatically turns the display off when the touchpanel is inactive for a specified time. Touch the screen to awaken the touchpanel and the last screen to be displayed reappears. The time value, represented by 90 in the illustration, can range from 0 (disables the timeout) to 120 (minutes). Two buttons, **UP** and **DOWN**, increase and decrease the timeout, respectively. Select the **Return** button to save the timeout setting and return to the SETUP MENU.

**DIAGNOSTICS MENU**

DIAGNOSTICS MENU		
Display EEPROM	Touch Screen Test	Display Configuration
Display Test Pattern	Display Color Bars	About...
Run Self Test	Return	

**Diagnostics Menu**

The **Diagnostics** button from the MAIN MENU should only be used under supervision from a Crestron customer service representative during telephone support. The options available from the DIAGNOSTICS MENU, shown to the left, are numeric in nature and their interpretation is beyond the scope of this manual.

---

**NOTE:** The “About...” button will display a screen indicating the current version of firmware residing on the touchpanel.

---

**Hardware Hookup**

The TPS-3100L can be mounted in a wall or inside a lectern. Make the necessary connections as called out in the illustration that follows this paragraph. For network wiring information, refer to “Network Wiring” on page 7 before attaching the 4-position mini-terminal block connector. Apply power after all connections have been made.

---

**CAUTION:** Do not apply excessive pressure to the touchscreen display during handling (mounting/installation). Doing so can crack the screen and damage the touchpanel.

---

**Hardware Connections for the TPS-3100L (Back of the Unit is Shown)**

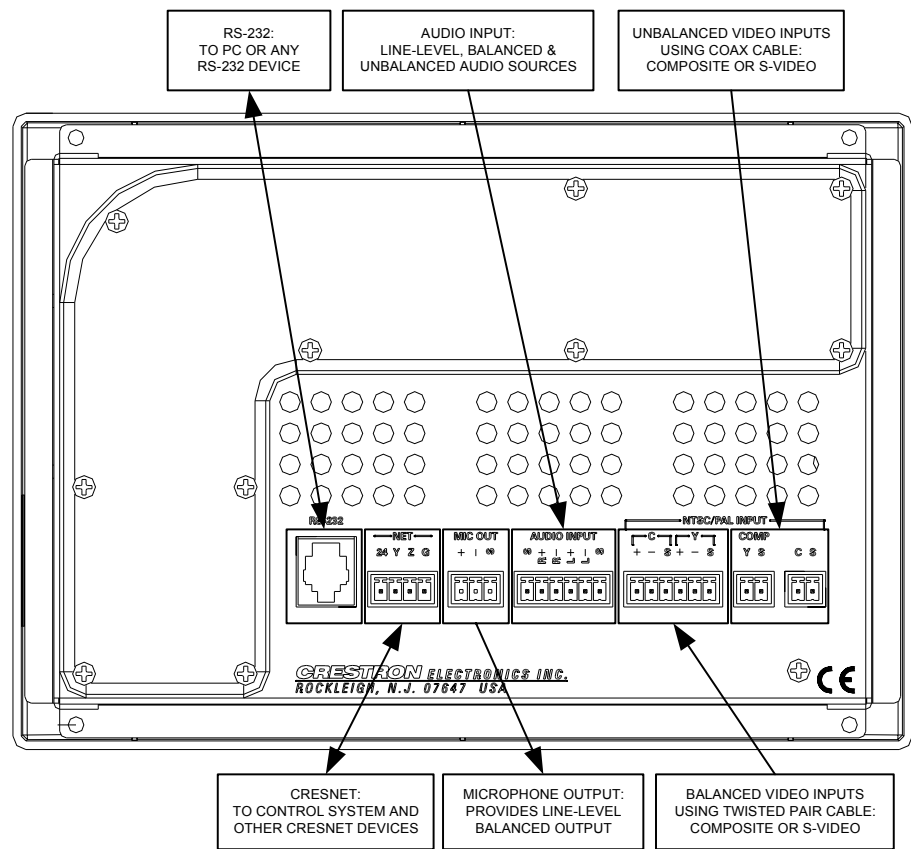

**RS-232**

This 6-position RJ-11 connector mates with a serial port of a PC. The connecting cable is not supplied. Prior to installation, use this port for direct connection between the touchpanel and a PC to load files to a touchpanel without a network connection. In the event that modular cables or an RJ-11 to DB9F adapter is not available, the table below and diagram on the next page provide information so that the cable can be fabricated on site. Refer to “RS-232 Menu” on page 14 for proper RS-232 port configuration settings.

**RS-232 Pinouts**

PIN #	DESCRIPTION	
1	CTS	
2	GND	
3	RXD	
4	TXD	
5	RTS	
6	N/C (Not connected)	

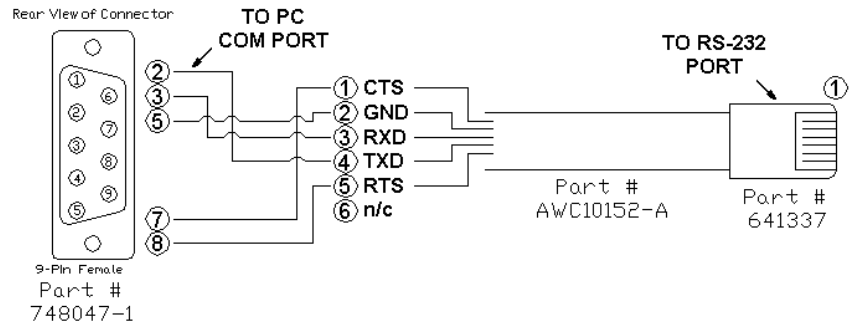
**PC to TPS-3100L Cable Specifications (Crestron Cable Number STCP-502PC)****NET**

This 4-position mini-terminal block connector provides Cresnet network connection from the touchpanel as well as power to the touchpanel. A description of the pinouts is shown in the table after this paragraph.

**NET Pinouts**

PIN #	DESIGNATION	DESCRIPTION
1	24	Power
2	Y	Data
3	Z	Data
4	G	Ground

**MIC OUT**

This 3-position mini-terminal block connector provides balanced line level microphone output with AGC. A description of the pinouts is shown in the table after this paragraph.

**MIC Pinouts**

PIN #	DESIGNATION	DESCRIPTION
1	+	Mic Output (Positive)
2	-	Mic Output (Negative)
3	S	Shield

**AUDIO INPUT**

This 6-position, mini-terminal block connector provides line level, balanced and unbalanced audio input. The pinouts are shown in the tables after this paragraph.

**AUDIO Pinouts-Balanced**

PIN #	DESIGNATION	DESCRIPTION
1	S	Shield
2	R+	Right Input (Positive)
3	R-	Right Input (Negative)
4	L+	Left Input (Positive)
5	L-	Left Input (Negative)
6	S	Shield

**NOTE:** When sending balanced audio from a CNX-BIPAD8 or CNX-PVID device, only the Positive (+) and Negative (-) wires are to be connected to the touchpanel. Do not connect the Shield (S) wires.

*AUDIO Pinouts-Unbalanced*

PIN #	DESIGNATION	DESCRIPTION
1	S	Ground
2	R+	Right Input (Positive)
3	R-	Right Ground
4	L+	Left Input (Positive)
5	L-	Left Input Ground
6	S	Ground

**NOTE:** Using two jumpers, connect R Shield to R - and L Shield to L - respectively at the TPS-3100L Audio Input connector. Refer to the following diagram.

*Wiring for Unbalanced Audio*

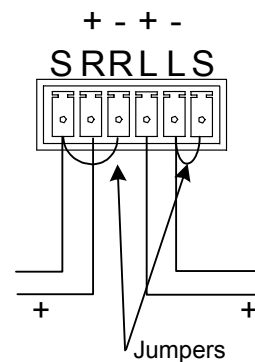

**NTSC/PAL INPUT**

This port provides unbalanced composite and S-video input (using a 2-position mini-terminal block connectors) or balanced video input (using a 6-position mini-terminal block connector) for video signals. Both sets of inputs support both NTSC and PAL formats. Balanced video format is typically used when distributing video via CAT 5 (i.e., from a Crestron CNX-PVID8x3 or 8x4). Unbalanced video is typically used when distributing video via coaxial cable.

**NOTE:** Cable runs for balanced video should not exceed 500 feet (152.4 meters) and cable runs for unbalanced video should not exceed 100 feet (30.5 meters). For distances greater than these specified lengths use a distribution amplifier.

*NTSC/PAL Balanced Video Input Pinouts*

PIN #	DESIGNATION	DESCRIPTION	
1	C(+)	Chrominance (Positive)	<p>The diagram shows a 6-pin connector for NTSC/PAL input. The pins are labeled as follows: Pin 1 is C(+), Pin 2 is C(-), Pin 3 is C(S), Pin 4 is Y(+), Pin 5 is Y(-), and Pin 6 is Y(S). The diagram also shows a separate connector for COMP (Y S) and another for C S.</p>
2	C(-)	Chrominance (Negative)	
3	C(S)	Chrominance (Shield)	
4	Y(+)	Luminance (Positive)	
5	Y(-)	Luminance (Negative)	
6	Y(S)	Luminance (Shield)	

**NOTE:** When sending balanced video from a CNX-BIPAD8 or CNX-PVID device, only the positive (+) and negative (-) wires are to be connected to the touchpanel. Do not connect the shield (S) wires.

## Mounting Options

The TPS-3100L touchpanel installs simply and cleanly into existing or newly constructed walls, with an assortment of pre- and post-construction mounting options. All mounting options are provided separately from the actual touchpanel. Refer to the table after this paragraph for a complete list of mounting options and respective Installation Guides for the TPS-3100L.

*Mounting Options for the TPS-3100L*

PRE-CONSTRUCTION* OPTION	POST-CONSTRUCTION** OPTION	MODEL NUMBER	DOCUMENT NUMBER
Back Box Kit	-	BB-3100L	6298
Pre-Construction Mount Kit	-	PMK-3100L	6297
Mud Mount Kit (accessory)	-	MMK-3100L	6296
Trim Mount Kit (accessory)	-	TMK-3100L	6295
-	Wall Mount Kit – Mud	WMKM-3100L	6296
-	Wall Mount Kit – Trim	WMKT-3100L	6295

\* Pre-construction refers to framed walls prior to hanging drywall.

\*\* Post-construction refers to framed walls with drywall hung.

**NOTE:** There is also a rack mount kit for the TPS-3100L (known as RMK-3100L). Refer to the latest version of the Installation Guide (Doc. 6299) which is available from the Crestron website ([www.crestron.com](http://www.crestron.com)).

If the BB-3100L or PMK-3100L are to be used and a touchpanel is not available, the installer can either leave the hole in the mounting surface open (if permitted by local building codes) or attach the cover plate supplied with the mounting kit.

## Touchpanel Mounting

### Required Tools

- #1 Phillips tip screwdriver

  1. If the cover plate is attached, use a #1 Phillips screwdriver to loosen and remove the four screws and plate.
  2. Connect all required cables to the touchpanel.
  3. Insert the touchpanel (without its faceplate) into the mounting option and align the four screw holes.
  4. Insert and tighten the four supplied screws (finger tight and then using a #1 Phillips screwdriver, tighten an additional 1/8-turn).
  5. Insert the five buttons. If the buttons are engraved, verify that the placement of the each button matches the programming.
  6. Cover the mounted unit with the faceplate. Refer to the illustration after this paragraph for guidance.

### Exploded View for Mounting the TPS-3100L in the Optional BB-3100L Back Box

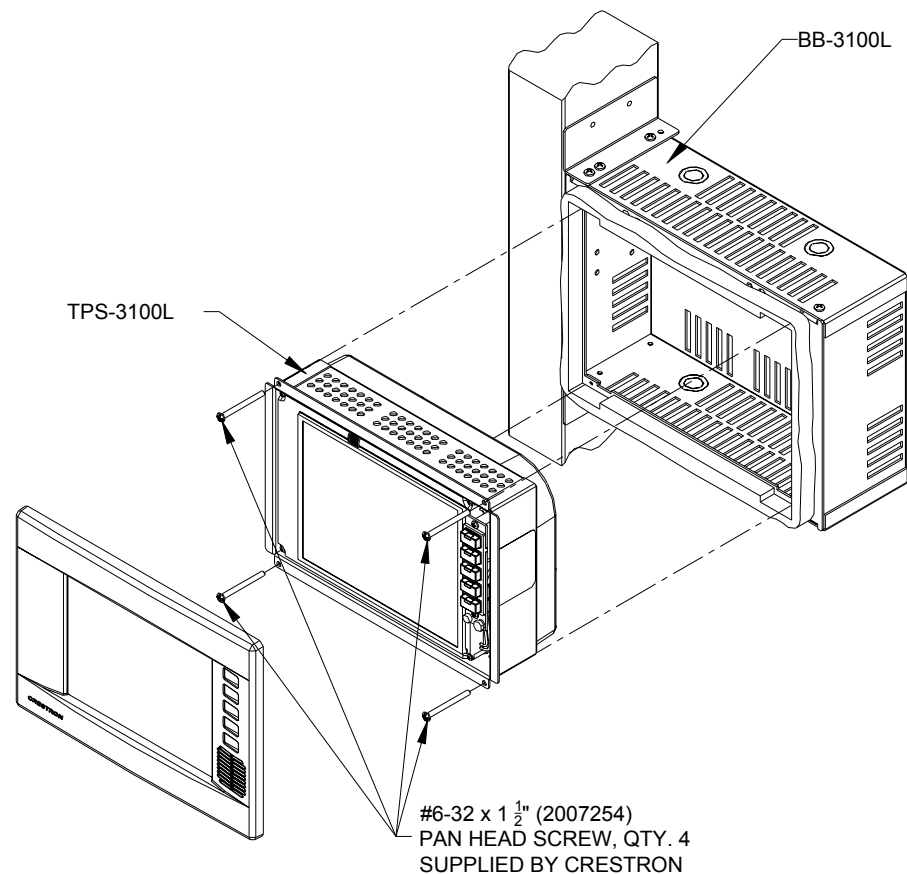

Optional custom engraved keys can be ordered (Crestron part number DB12-BTN) separately by using the Crestron Engraver Software. Version 2.2.1.2 or later is available from the Downloads | Software Updates section of the Crestron website ([www.crestron.com](http://www.crestron.com)).

## Touchpanel Removal

If it is necessary to remove the touchpanel after it has been installed into a mounting surface, complete the following steps in the order provided to remove the touchpanel. The only tool required is a #1 Phillips tip screwdriver.

1. Lift the plastic cover off the touchpanel. Do not apply excessive pressure to the touchscreen.
2. Remove the plastic buttons from the touchpanel. If the buttons are engraved, be sure to record the button engraving with the button location so that the buttons can be properly returned.
3. Loosen and remove the four screws that secure touchpanel to the mounting option in use.
4. Using equal pressure, carefully remove the touchpanel from the opening.
5. If necessary, secure and label the attached cables before disconnecting them from the back of the touchpanel.

## Recommended Cleaning

Keep the surface of the touchscreen free of dirt, dust, or other materials that could degrade optical properties. Long-term contact with abrasive materials can scratch the surface, which may detrimentally affect image quality.

For best cleaning results, use a clean, damp, non-abrasive cloth with any commercially available non-ammonia glass cleaner. The faceplate may not provide a complete watertight seal. Therefore, apply cleaning solution to the cloth rather than the surface of the touchscreen. Wipe touchscreen clean and avoid ingress of moisture beneath panels.

---

## Programming Software

---

### Have a question or comment about Crestron software?

Answers to frequently asked questions (FAQs) can be viewed in the Online Help section of the Crestron website ([www.crestron.com](http://www.crestron.com)). Go to <http://support.crestron.com> to post your own question or view questions you have submitted to Crestron's True Blue Support. First-time users will need to establish a user account.

---

Setup is easy thanks to Crestron's Windows®-based programming software. Crestron Application Builder™ (AppBuilder) creates a complete project, with no special programming required. Crestron AppBuilder completes all necessary programming for a base system including all touchpanel screens and the control system program. Once Crestron AppBuilder creates the project, the system interfaces and program logic can be customized with other Crestron development tools such as SIMPL Windows and Crestron VisionTools Pro-e (VT Pro-e).

The program output of Crestron AppBuilder is a SIMPL Windows program with much of the functionality encapsulated in macros. Therefore, extending the capabilities of the system is very easy. Crestron AppBuilder and SIMPL Windows are intended for users with different levels of programming knowledge. Crestron AppBuilder is easier to use for the beginning programmer, and much faster for all



programmers. However, it does not allow the degree of control and flexibility that SIMPL Windows does. Of course, one can initiate programming using the easiest method (Crestron AppBuilder) and use advanced techniques that are available from SIMPL Windows to customize the job.

Crestron AppBuilder comes with templates for all supported interfaces. If a user wishes to create a touchpanel project using templates with a different look-and-feel this can be accomplished by making a custom template. This custom template can then be used by Crestron AppBuilder to create the final project files to be loaded into the panels. Alternatively, VT Pro-e can be used to tweak projects created with Crestron AppBuilder or develop original touchpanel screen designs.

---

**NOTE:** AppBuilder does not have direct support for the TPS-3100L. However, the template for the TPS-3000L can be used for installations requiring a TPS-3100L.

---

For QuickMedia™ applications using the TPS-3100L, Crestron recommends using System Builder™ (SystemBuilder) software. SystemBuilder has similar functionality to AppBuilder, but is optimized for programming QuickMedia systems. A future release of SystemBuilder (due in fourth quarter of 2004) will also be able to configure and program distributed audio systems.

For lighting and home automation applications using the TPS-3100L, Crestron recommends using D3 Pro™ Lighting and Automation System software. D3 Pro has similar functionality to AppBuilder and SystemBuilder, but is optimized for programming lighting and home automation systems.

The following are the minimum required software versions for the PC:

- (Optional) System Builder version 2.0 (due in fourth quarter of 2004) or later with System Builder Templates version 1.01 or later. Requires SIMPL Windows.
- (Optional) D3 Pro version 1.2.7 or later. Requires SIMPL Windows.
- SIMPL Windows version 2.05.22 or later with Library Update 302 or later. Requires SIMPL+ Cross Compiler version 1.1.
- Crestron Database version 16.3.4 or later. Required by SIMPL Windows, VT Pro-e, and Crestron Engraver.
- Crestron VisionTools Pro-e version 3.2.18 or later. Used for graphical touchscreen design.
- Crestron Engraver 2.2.1.2 or later.

The latest versions can be obtained from the Downloads | Software Updates section of the Crestron website ([www.crestron.com](http://www.crestron.com)). Crestron software and any files on the website are for Authorized Crestron dealers and Crestron Authorized Independent Programmers (CAIP) only. New users may be required to register to obtain access to certain areas of the site (including the FTP site).

---

**NOTE:** The TPS-3100L touchpanel is supplied with five blank pushbuttons. Optional custom engraved keys can be ordered separately by using the Crestron Engraver Software. Version 2.2.1.2 or later is available from the Downloads | Software Updates section of the Crestron website ([www.crestron.com](http://www.crestron.com)).

---

Digital, analog and serial join numbers are a common thread between VT Pro-e and SIMPL Windows. These numbers define how the objects on a touchpanel page of a VT Pro-e project interface to the outside world, specifically the Cresnet system as defined in the SIMPL Windows program. There are digital join numbers that carry

out some predetermined function (a logical high or low); analog join numbers for displaying incremental values, sliders, gauges and bar graphs; and serial join numbers that allow for the display of variable text and transmission/reception of serial commands from other manufacturers. Unjoined objects are not interfaced with the system and thus cannot initiate any logic functions (although they can perform page flips).

*The easiest method of programming, but does not offer as much flexibility as SIMPL Windows.*

## Programming with the Crestron AppBuilder

Crestron AppBuilder offers automatic programming for such residential and commercial applications as audio distribution, home theater, video conferencing, and lighting. The interface of this tool guides you through a few basic steps for designating rooms and specifying the control system, touchpanels, devices, and functionality. Crestron AppBuilder then programs the system, including touchpanel projects and control system logic.

Crestron AppBuilder is fully integrated with Crestron's suite of software development tools, including SIMPL Windows, VT Pro-e, and the Crestron Database. Crestron AppBuilder accesses these tools behind the scenes, enabling you to easily create robust systems.

## Programming with SIMPL Windows

---

**NOTE:** The following assumes that the reader has knowledge of SIMPL Windows. If not, refer to the extensive help information provided with the software.

**NOTE:** The following are acceptable file extensions for programs that include a TPS-3100L, developed for specific control system types:

- .smw: *projectname.smw* (SIMPL Windows source file)
- .spz: *projectname.spz* (compiled file for 2-Series)
- .bin: *projectname.bin* (compiled file for CNX generation)
- .csz: *projectname.csz* (compiled file for CNX generation with SIMPL+)
- .ush: *projectname.ush* (compiled file for CNX generation with SIMPL+ header file)
- .usp: *projectname.usp* (source code module for SIMPL+)
- .umc: *projectname.umc* (user macro for SIMPL)

---

**NOTE:** In the following description, the PRO2 control system is used.

SIMPL Windows is Crestron's software for programming Crestron control systems. It provides a well-designed graphical environment with a number of workspaces (i.e., windows) in which a programmer can select, configure, program, test, and monitor a Crestron control system. SIMPL Windows offers drag and drop functionality in a familiar Windows® environment.

This section describes a sample SIMPL Windows program that includes a TPS-3100L touchpanel. A Join Number Remapping (JNR) program can be written to augment the functionality of the touchpanel by making some of the touchpanel's internal functions available to the SIMPL Windows programmer. Refer to "Join Number Remapping" on page 26 for more information.

Configuration Manager is where programmers "build" a Crestron control system by selecting hardware from the *Device Library*. In Configuration Manager, drag the PRO2 from the Control Systems folder of the *Device Library* and drop it in the upper pane of the *System Views*. The PRO2 with its associated communication ports is displayed in the *System Views* upper pane.

**PRO2 System View**

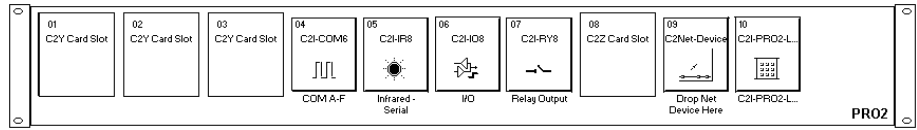

The *System Views* lower pane displays the PRO2 system tree. This tree can be expanded to display and configure the communications ports.

**Expanded PRO2 System Tree**

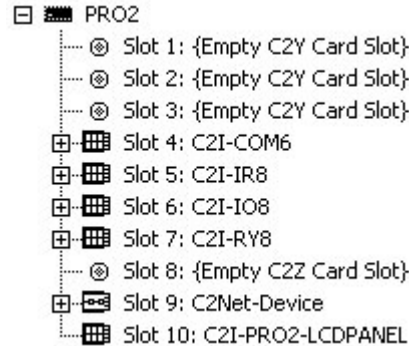

**C2Net-Device Slot in Configuration Manager**

To incorporate the TPS-3100L touchpanel into the system, drag the TPS-3100 from the Touchpanels | Touchpanels (Cresnet) folder of the *Device Library* and drop it in the *System Views*. The PRO2 system tree displays the touchpanel in slot 9 with a default Net ID of 03 as shown in the following illustration.

**NOTE:** The first touchpanel in a system is preset with a Net ID of 03, when its symbol is dragged into the upper pane of *System Views*. Additional touchpanels are assigned different Net ID numbers as they are added.

**C2Net Device, Slot 9**

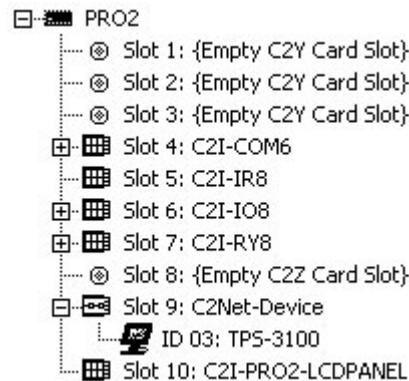

**Setting the Net ID in Device Settings**

Double-click the TPS-3100 icon to open the “Device Settings” window. This window displays the TPS-3100 device information. If necessary, select the *Net ID* tab to change the Net ID, as shown in the following figure.

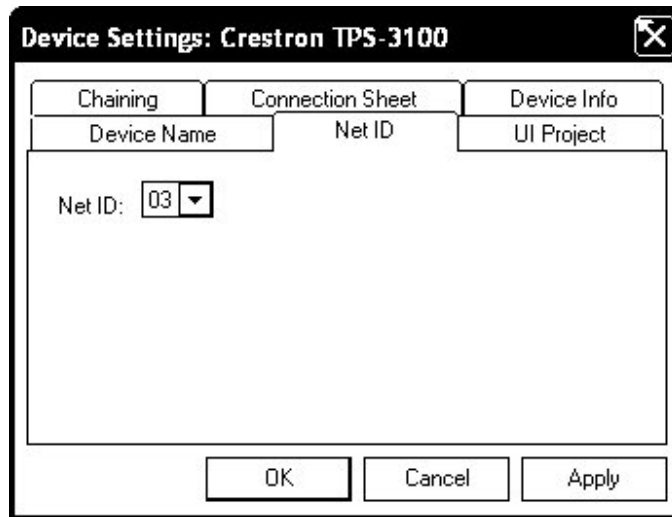
*“Device Settings” Window for the TPS-3100*

**NOTE:** SIMPL Windows automatically changes Net ID values of a device added to a program if a duplicate device or a device with the same default Net ID already exists in the program. Always ensure that the hardware and software settings of the Net ID match. For Net ID hardware settings details, refer to “Identity Code” on page 9.

### ***TPS-3100 Symbol in Programming Manager***

Programming Manager is where programmers “program” a Crestron control system by assigning signals to symbols. The following diagram shows the TPS-3100 symbol in the SIMPL Windows’ Programming Manager.

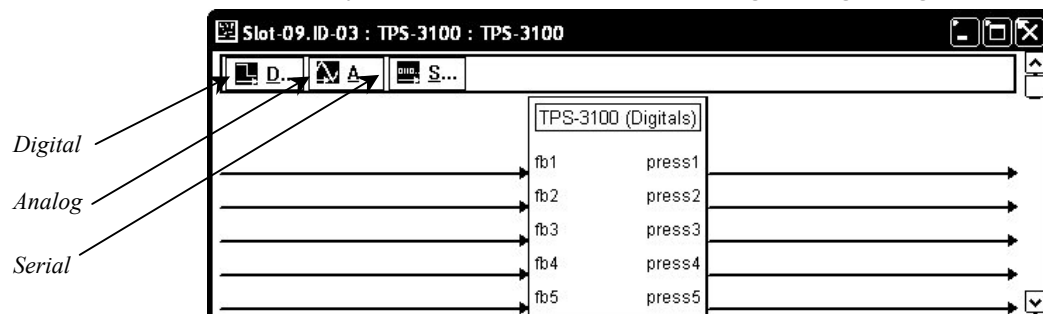
*Detail View of the TPS-3100 in SIMPL Windows’ Programming Manager*

**NOTE:** Join numbers are expandable to 4000 digital & analog, 999 serial.

### **Signal Types**

Signals interconnect the various devices and logic symbols that comprise a SIMPL program. Signals can be one of three types: digital, analog, or serial. For any given signal, the signal type is determined by its driving source. That is, if the symbol that drives the signal has an analog output, then, by definition, the connecting signal is analog.

In SIMPL Windows, the signal types are color-coded as follows:

**Digital = Blue**

**Analog = Red**

**Serial = Black**

**Undefined/Other = Green**

---

**NOTE:** “Other” signals are a combination of the three basic types (e.g. many symbols accept either analog or serial signals; the combination is shown as a green signal). The signal type is displayed on the Status Bar when the signal is highlighted.

---

For additional information, refer to the latest version of the Crestron SIMPL Windows Symbol Guide (Doc. 6120). It can be downloaded from the Downloads | Product Manuals | Software section of the Crestron website ([www.crestron.com](http://www.crestron.com)).

### **Digital Signals**

A digital signal contains one bit of information and usually takes on one of two values: 1 or 0. These two digits can represent the logical values true and false, and they can be represented in an electronic device by the states on/off or high/low, recognized as two voltage levels. (Other common descriptors are active/inactive.)

### **Analog Signals**

Unlike digital signals, analog signals can vary continuously in value, in the same manner as a parameter such as volume, temperature, or pressure. Analog signals contain 16 bits of information, which means that this type of signal can have values ranging from 0 to 65535 ( $2^{16}-1$ ). This 16-bit property makes analog signals useful for controlling devices that do not have discrete settings, such as volume controllers, pan/tilt head controllers, and lighting dimmers.

### **Serial Signals**

Serial signals are much like analog signals, in that they, too, contain 16 bits of information. However, whereas the value of an analog signal is used directly to control volume or temperature, for instance—the value of the serial signal is used as a pointer to a location in memory that contains a string of characters. When a serial signal is routed to a symbol, that symbol can identify the signal as serial rather than analog and it will automatically look at the data it points to.

Thus serial signals are used to facilitate the transmission of serial data (strings of characters). These signals can be generated by incoming data on a COM port or by a symbol that has a serial output.

### **TPS-3100 Input/Output Signals**

The TPS-3100 symbol provides up to 4000 digital input and output joins, 4000 analog input and output joins, and up to 999 serial input joins. The programmer selects the signal types by clicking on the appropriate button at the top of the *Symbol Detail* view when programming the panel.

The following tables list and give functional descriptions for the touchpanel outputs and inputs.

*Digital Output Signal Descriptions*

OUTPUT	DESCRIPTION
press 1 through press 4000	Notifies control system of a button press on the touchpanel screen (1 - 4000). High/1 = Button being pressed Low/0 = Button not being pressed

*Digital Input Signal Descriptions*

INPUT	DESCRIPTION
fb 1 through fb 4000	Notifies panel of digital feedback (1 - 4000). This can represent that a touchpanel button was pressed or can be an actual device feedback, e.g., that power was turned on.

*Analog Output Signal Descriptions*

OUTPUT	DESCRIPTION
an_act 1 through an_act 4000	Notifies control system of an action that produces an analog change (i.e. a moving slider control) (1 - 4000). Any value from 0 through 65535

*Analog Input Signal Descriptions*

INPUT	DESCRIPTION
an_fb 1 through an_fb 4000	Notifies panel of analog feedback (1 - 4000).

*Serial Input Signal Descriptions*

INPUT	DESCRIPTION
text-01 through text-999	Notifies panel of new dynamic text string (1 - 999). Also called indirect text.

**Device Extenders**

Device extenders provide additional logic and functionality to a device. The Poll Manager and Sleep/Wake Manager symbols are device extenders for touchpanels. Poll Manager takes the touchpanel on and off line during polling by the control system. Sleep/Wake Manager suspends and restores operation of the touchpanel. For additional information about Device Extenders, refer to the latest version of the Crestron SIMPL Windows Symbol Guide (Doc. 6120), or the on-line help included with SIMPL Windows.

**Example Program**

An example program for the TPS-3100L is available from the Crestron FTP site (<ftp.crestron.com/Examples>). Search for the file TPS-3100\_SIMPL\_Windows\_example\_(Doc.6076)\_TPS-3100L\_(Doc. 6291).smw that contains the example program.

**Join Number Remapping**

Join Number Remapping (JNR) is a programming concept that allows a TPS series panel to use join numbers with values over 4000 (join numbers 4001 to 15999 and reserved join numbers) by bringing them within the range of the TPS touchpanel symbol, thereby increasing a touchpanel's functionality. Through JNR, a TPS series panel's internal functions become accessible to a control system and can activate the local functions of other touchpanels, route its internal feedback back to the control system, and receive feedback from remote locations. JNR provides the additional capability of managing IP IDs in Ethernet applications where a touchpanel communicates with multiple control systems that have been uploaded with the same

program. Refer to the latest version of the Crestron 2-Series Control Systems Reference Guide (Doc. 6256) and the SIMPL Windows help file for more details.

## Programming with Crestron VisionTools® Pro-e

VT Pro-e, a design and programming Windows®-based software, permits the creation of unlimited control screen variations incorporating two and three-dimensional graphics and text as well as video and sounds (recorded as WAV files). A set of pages, which make up a project, can be designed for each TPS-3100L touchpanel application. Each page contains objects such as custom control graphics, two and three-dimensional buttons, sliders, and digital readouts which allow the user to interface with the control system via join numbers. Unjoined objects are not interfaced with the system and thus cannot initiate any functions. The completed and compiled project is uploaded to the touchpanel and programmed into the flash PROM via the **File | Upload Project** command. The touchpanel uses the programmed project until another project is uploaded from the PC. Projects cannot be extracted from the touchpanel. The PC may be disconnected from the control system or panel except during reprogramming. VT Pro-e also allows users the option to generate projects destined for web browsers rather than for physical touchpanels.

Crestron's Synapse image-rendering algorithm supports advanced anti-aliasing for crisper, sharper images, as well as new shaded styles for all objects, new frame styles (neon and raised), and new text styles (embossed, raised, and shadow). The Synapse algorithm allows the touchpanel to process these styles internally, without the use of large bitmap files that increase project size and upload time. Synapse delivers high impact touchpanel graphics more efficiently than ever. To utilize Synapse graphics, you must use VT Pro-e version 3.1.2.0 or later and Isys touchpanel firmware 2.060.0 or later.

For additional software information, refer to the help file provided with the software. The latest version of VT Pro-e can be obtained from the Downloads | Software Updates section of the Crestron website ([www.crestron.com](http://www.crestron.com)).

---

**NOTE:** The following are acceptable file extensions for programs that include a TPS-3100L:

.vtp	<i>projectname.vtp</i> (VT Pro-e source file)
.vtt	<i>projectname.vtt</i> (VT Pro-e template file)
.vtz	<i>projectname.vtz</i> (compiled file)

---

### Multi-Mode Objects

*Multi-mode objects offer high-performance programming!*

The single most-advanced VT Pro-e high-performance programming technique involving the TPS-3100L is the concept of multi-mode objects. A multi-mode object (i.e., button, legend, etc.) is an object drawn on a VT Pro-e page that can have one or more active and inactive visible settings (*modes*).

For examples, refer to the MULTI-MODE\_OBJECT\_EXAMPLES\_OF\_VTPRO-E\_PROJECTS\_USE\_WITH\_ISYS\_TOUCHPANELS.ZIP file. It is available from the Crestron FTP site ([ftp.crestron.com/Examples](ftp://ftp.crestron.com/Examples)). This file contains the VT Pro-e touchpanel files and SIMPL Windows files that illustrate the high-performance capabilities of multi-mode objects.

### WAV File Audio Messages

The TPS-3100L is capable of playing audio messages as system prompts and responses. These files are recorded as WAV files on a PC using an audio utility such as Sound Recorder that is packaged with Microsoft Windows 95/98/Me/XP/NT/

2000™. Files from other sources may also be converted to an acceptable format by using this or a similar utility. Many other audio utilities are available commercially or as shareware. The TPS-3100L touchpanel only accepts the following WAV file format: **PCM, 8KHz, mono, 8 bit**. For more information about how to use Sound Recorder, refer to its User's Guide and extensive help information provided with the software.

Pre-recorded WAV files for voice prompts and responses are available from Crestron. These files can be stored into and programmed for use in the touchpanel directly or may be edited with the Sound Recorder. For example, the individual files can be combined to create custom messages.

---

**NOTE:** WAV files (for the TPS-3100L touchpanel) can be obtained from the Wave LC Library of the Crestron FTP site (<ftp://ftp.crestron.com/Wave LC/>).

Since the CT/LC-1000 touchpanel accepts the same WAV file formats, only use those WAV files designated for the CT/LC-1000, TPS-2000L, TPS-3000, or TPS-3100L touchpanels. These WAV files are different than those made available for the CNXTA, Crestron CNX Telephone Audio Interface Card.

**NOTE:** WAV files reside in the touchpanel's Flash memory and will affect the amount of available space for touchpanel screens.

---

### Sound Manager

---

**NOTE:** If keyclick is enabled on a touchpanel, each press of the touchpanel results in an audible click. It may be desirable to conceal the keyclick sound for certain buttons (e.g., if the button triggers playing of a WAV file). Using VT Pro-e, the panel designer has the option to suppress the keyclick on a button-by-button basis from the "Button Properties" window. A button must have a page flip or a join number other than "0" assigned for it to click.

---

Crestron VT Pro-e (version 2.1.0 and later) contains an audio tool, Sound Manager, which permits the panel designer to attach WAV files to a touchpanel project. Sound Manager is available from the Tools pull-down menu and opens the "Sound Manager" window, shown after this paragraph.

#### **"Sound Manager" Window**

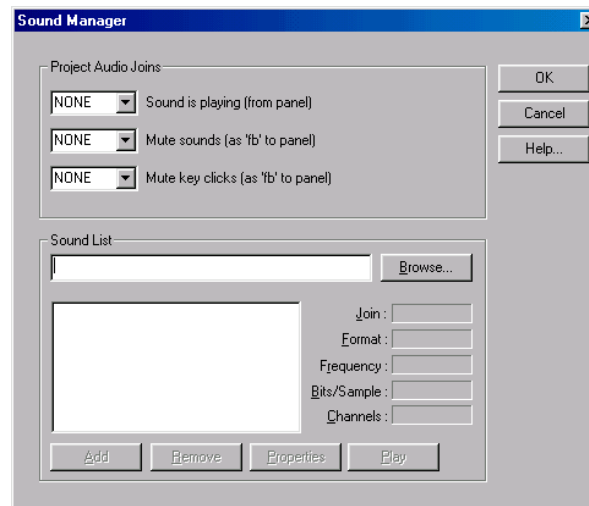



Sound Manager Guidelines

There are three things to keep in mind when using Sound Manager.

1. Each WAV file must be assigned a unique digital join number. The join number options include none, keyclick, or a number (1 through 4000). The default is none. If the keyclick option is selected, this WAV file becomes the default keyclick sound for all buttons. The other WAV files can be played by having the SIMPL Windows program assert the feedback side of the assigned join number.
2. Each WAV file must have the correct audio format and attributes for the TPS-3100L target type selected in VT Pro-e. The correct audio format is PCM, 8KHz, mono, 8 bit.
3. There are three system-wide join numbers that the designer can define. The first, sound playing from panel, differs from the other two in that it is triggered from the panel.
  - a. Sound Playing from Panel – The signal for this join number goes high when the WAV file plays.
  - b. Mute Sounds – All WAV files (except the keyclick) in the project are muted when this join number goes high.
  - c. Mute Key Click – The keyclick sound is muted when this join number goes high.

Using Sound Manager

Sound Manager is broken into two distinct components. The *Project Audio Joins* component, shown below, permits the designer to assign the three system-wide join numbers described in the previous section. The three system joins can be assigned automatically with the **Auto** button or by scrolling down to the desired number.

**Project Audio Joins Component**

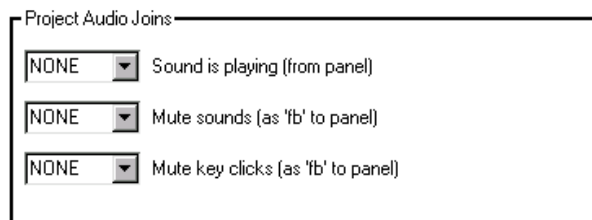

The *Sound List* component, shown below, permits the designer to attach WAV files to the touchpanel project. Complete the following steps to attach (add) a WAV file.

**Sound List Component**

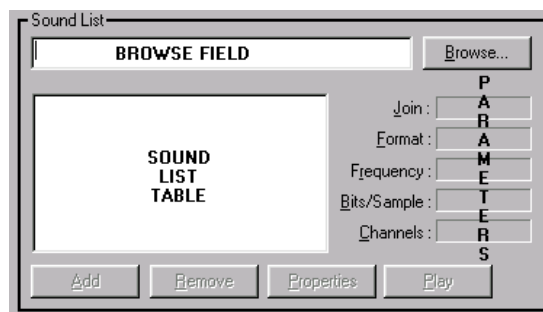

1. Use the **Browse** button to locate the desired WAV files. It should appear in the field adjacent to the **Browse** button.
2. If necessary, select the **Play** button to verify that the file in the browse field is the desired file.
3. Select the **Add** button to transfer the WAV file to the *Sound List* table located below the browse field. The audio parameters of the file also appear to the right of the table.
4. Repeat steps 1 through 3 for each desired WAV file.

---

**NOTE:** To remove a WAV file from the *Sound List* table, highlight the file and click on the **Remove** button.

---

5. Select a WAV file in the *Sound List* table and click **Properties** to open the “Sound Properties” window. Assign a join number either automatically with the **Auto** button or by scrolling down to the desired number. Select **Description** to enter comments about the WAV file and click **OK** when done.

---

**NOTE:** The assigned WAV file will play once when the feedback join goes high.

---

6. Repeat for each WAV file.

## “Quick” Pushbuttons

The touchpanel includes five “quick” pushbuttons, located on the side of the LCD screen. These buttons can be programmed to access any frequently used command. Each button has a permanently fixed digital join number. The sequence of digital join numbers is (top to bottom) 1 through 5. Refer to the following diagram that illustrates the buttons and their assigned join numbers.

### *Pushbutton Layout and Join Number Assignment*

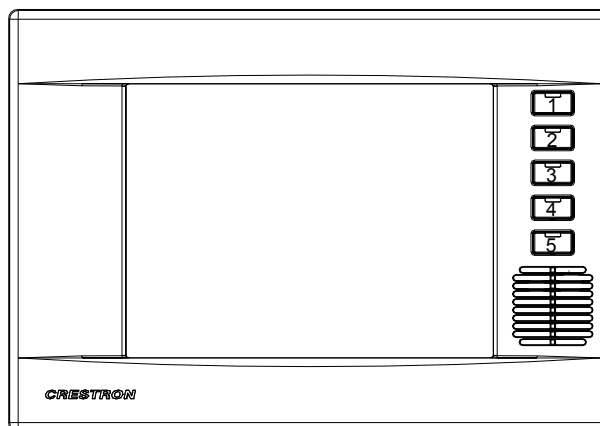

---

**NOTE:** A VT Pro-e sample project, TPS-3100L.VTP, is available from the VT Pro-e section of the Crestron FTP site (<ftp://ftp.crestron.com/VTPro-E/>). This project provides guides for panel designers so that they can line up objects with the five “quick” pushbuttons that flank the LCD display. New users are required to register in order to obtain access to the FTP site.

---

## Reserved Join Numbers

A reserved join number is a feature of the software that enables a designer to create a button that completes a predetermined function. The tables on the next few pages provide lists of reserved join numbers available within the software.

**NOTE:** Many touchpanel configuration “shortcuts” are available via the software. A button can be created on a page that either calls up the Preferences Menu, adjusts brightness, etc., via reserved join numbers.

**NOTE:** Reserved join numbers can also be automatically activated by a control system when using join number remapping. Refer to “Join Number Remapping” on page 26 for more information.

### *System Analog Reserved Join Numbers for TPS-3100L Touchpanels*

JOIN #	FUNCTION	VALUE	IN/OUT
17201	Brightness	LCD Brightness	INPUT/OUTPUT

### *System Digital Reserved Join Numbers for TPS-3100L Touchpanels*

JOIN #	FUNCTION	VALUE	IN/OUT
17216	Brightness	Increase	INPUT
17217	Brightness	Decrease	INPUT
17218	Brightness	High	INPUT
17219	Brightness	Medium	INPUT
17220	Brightness	Low	INPUT
17242*	Call up Setup Menu	N/A	INPUT

\* Signal must be held for three seconds to call up the Setup Menu.

### *Audio Analog Reserved Join Numbers for TPS-3100L Touchpanels*

JOIN #	FUNCTION	VALUE	IN/OUT
17301	Audio Line	Volume	INPUT/OUTPUT
17302	WAV Audio	Volume	INPUT/OUTPUT
17307	Audio Master	Volume	INPUT/OUTPUT

### *Audio Digital Reserved Join Numbers for TPS-3100L Touchpanels*

JOIN #	FUNCTION	VALUE	IN/OUT
17300	Audio	On	INPUT/OUTPUT
17301	Audio	Off	INPUT/OUTPUT
17302	Key Click	On	INPUT/OUTPUT
17303	Key Click	Off	INPUT/OUTPUT
17304	Key Click Volume	Increase	INPUT
17305	Key Click Volume	Decrease	INPUT
17306	Audio Line	On	INPUT/OUTPUT
17307	Audio Line	Off	INPUT/OUTPUT
17308	Audio Line Volume	Increase	INPUT
17309	Audio Line Volume	Decrease	INPUT

*(continued on next page)*

*Audio Digital Reserved Join Numbers for TPS-3100L Touchpanels (continued)*

JOIN #	FUNCTION	VALUE	IN/OUT
17312	Audio WAV	On	INPUT/OUTPUT
17313	Audio WAV	Off	INPUT/OUTPUT
17314	Audio WAV Volume	Increase	INPUT
17315	Audio WAV Volume	Decrease	INPUT
17318	Mic AGC	On	INPUT
17319	Mic AGC	Off	INPUT
17329	Audio Master Volume	Increase	INPUT
17330	Audio Master Volume	Decrease	INPUT

*Key Feedback Digital Reserved Join Numbers for TPS-3100L Touchpanels*

JOIN #	FUNCTION	VALUE	IN/OUT
17906	Key Feedback Brightness	Increase	INPUT/OUTPUT
17907	Key Feedback Brightness	Decrease	INPUT/OUTPUT

*Key Feedback Analog Reserved Join Numbers for TPS-3100L Touchpanels*

JOIN #	FUNCTION	VALUE	IN/OUT
17901	Key Feedback	Brightness	INPUT/OUTPUT

**NOTE:** Additional touchpanel functions with reserved join numbers can also be accessed in VT Pro-e or by using Join Number Remapping in a SIMPL Windows program. A listing of available reserved join functions are available when assigning a Press Join in a "Button Properties" window in VT Pro-e or when using Join Number Remapping in SIMPL Windows. For additional information on VT Pro-e, refer to the help file provided with the software. For additional information on Join Number Remapping, refer to "Join Number Remapping" on page 26.

## MultiByte International Characters

Most languages use a single byte of 8 bits to represent a character, e.g. English, French, German, Hebrew, Russian, Thai, etc.

Multibyte character fonts require more than the usual 8 bits to specify a character. This occurs when a language has more than 256 characters ( $2^8$ ) in a font. For example, Chinese fonts contain several thousand characters. Other multibyte languages include Japanese and Korean.

There are two separate issues with multibyte characters - static text on buttons and indirect text on buttons. No Isys touchpanel firmware changes are required in either case.

Static text on a button, entered in the standard way in VTPro-e, always works under Windows 98. Under Windows XP, you must use VTPro-e 3.0 or later.

Indirect text on a button is entered in VTPro-e and the actual string to be displayed is entered in SIMPL Windows. You must use VTPro-e 3.0 or later to guarantee that the full set of characters in the font is stored on the touchpanel. You must use SIMPL Windows 2.03.11 or later to enter Chinese characters directly. As of this publication date, only completely single byte or completely multibyte strings may be entered or

they will not be compiled correctly in SIMPL Windows. In other words, you cannot enter Chinese character interspersed with numbers. You can enter Chinese characters or numbers in separate strings. Crestron is scheduling time to fix this in the near future and the release notes for SIMPL Windows will mention it.

Of course, you can always use the workaround of showing a graphic that displays the string, but it is not dynamic.

---

## Uploading and Upgrading

Assuming a PC is properly connected to the entire system, Crestron programming software allows the programmer to upload programs and projects to the system and touchpanel after their development. However, there are times when the files for the program and projects are compiled and not uploaded. Instead, compiled files may be distributed from programmers to installers, from Crestron to dealers, etc. Even firmware upgrades are available from the Crestron website as new features are developed after product releases. In those instances, one has the option to upload via the programming software or to upload and upgrade via the Crestron Viewport.

---

**NOTE:** The Crestron Viewport is available as a pull-down command from SIMPL Windows and VT Pro-e (**Tools | Viewport**) or as a standalone utility. The Viewport utility performs multiple system tasks, primarily via an RS-232 or TCP/IP connection between the control system and a PC. It is used to observe system processes, upload new operating systems and firmware, change system and network parameters, and communicate with network device consoles and touchpanels, among many other tasks. Viewport can also function as a terminal emulator for generic file transfer. All of these functions are accessed through the commands and options in the Viewport menus. Therefore, for its effectiveness as a support and diagnostic tool, the Crestron Viewport may be preferred over development tools when uploading programs and projects.

---

The following sections define how one would upload a SIMPL Windows program, VT Pro-e project or upgrade the firmware of the TPS-3100L touchpanel. However, before attempting to upload or upgrade, it is necessary to establish communications.

### Communication Settings

Connection of a PC to the TPS-3100L touchpanel can be direct via the RS-232 port on the touchpanel or through a control system (Cresnet). Both methods of connection provide setup for RS-232 communication.

---

**NOTE:** For laptops and other PCs without a built-in RS-232 port, Crestron recommends the use of PCMCIA cards, rather than USB-to-serial adapters. If a USB-to-serial adapter must be used, Crestron has tested the following devices with good results:

Belkin (large model) F5U103  
I/O Gear GUC232A  
Keyspan USA-19QW (Discontinued)

Results may vary depending on the computer being used. Other models, even from the same manufacturer, may not yield the same results.

---

To prepare the TPS-3100L for uploading or upgrading, refer to the following figure for a typical connection diagram.

*Typical Connection Diagram when Uploading a Touchpanel Project or Firmware*

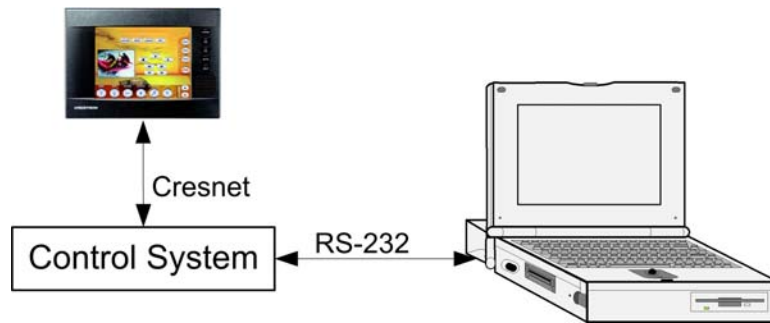

Alternatively, touchpanel projects and firmware can be directly uploaded to the touchpanel from a PC without the use of a control system. To prepare the TPS-3100L for uploading or upgrading directly from a PC, refer to the following figure. Connect the RS-232 port of the computer directly to the RS-232 port of the touchpanel. Refer to page 15 for RS-232 cable information.

---

**NOTE:** Directly connecting to the touchpanel over RS-232 provides a faster transmission speed than Cresnet.

---

**NOTE:** The touchpanel must be connected to 24 VDC and ground.

---

*Typical Connection Diagram when Uploading a Touchpanel Project or Firmware Directly to the Touchpanel*

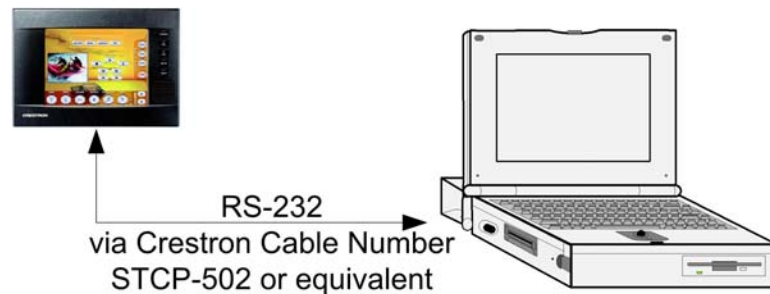



---

**NOTE:** For cable pinouts, refer to “RS-232” on page 15.

---

1. Open the Crestron Viewport.  
Either launch the stand-alone version of Viewport, or start SIMPL Windows, and from the menu bar, select **Tools | Viewport**.
2. Refer to the following figure. From the Viewport menu, select **Setup | Communications settings** (alternatively, press **Alt+D**) to open the “Port Settings” window.

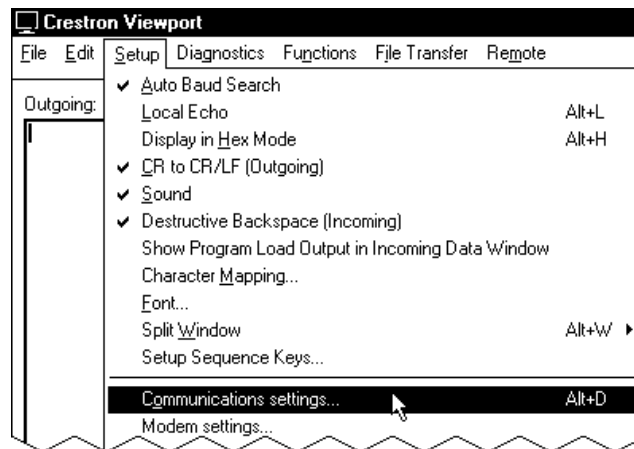
*Setup | Communications Settings Command*



3. Select **RS-232** as the connection type. Verify that an available COM port (COM 1 is shown after this step) is selected, and that all communication parameters and necessary options from the “Port Settings” window are selected as shown after this step. Click the **OK** button to save the settings and close the window.

*“Port Settings” Window*

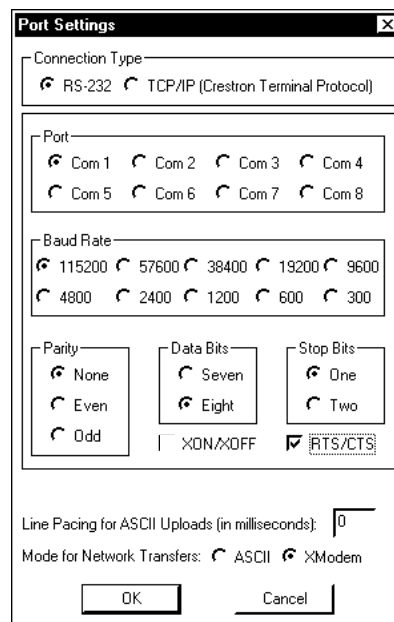

**NOTE:** The parameters shown in the previous illustration are the port settings for a 2-Series control system. Consult the Operations Guide for the control system being used for exact parameter selection. Default communication parameters for the touchpanel are 115200, 8 bit, parity none, stop bit 1, XON/XOFF off, RTS/CTS off.

**NOTE:** If connecting to the touchpanel through a control system, the baud rate may need to be set to 38400 baud (Cresnet speed) for a successful transfer.

- To verify communication, select **Diagnostics | Establish Communications (Find Rack)**. This should display a window that gives the COM port and baud rate. If communication cannot be established, refer to the “Troubleshooting Communications” section in the latest version of the Crestron 2-Series Control Systems Reference Guide (Doc. 6256) or the respective Operations Guide for the control system.

## Uploading a SIMPL Windows Program

*A control system source file has the extension .smw. A compiled SIMPL Windows file has the extension .spz for a 2-Series control system, .bin for CNX generation, and .csz for CNX generation with SIMPL+.*

The SIMPL Windows file can be uploaded to the control system using SIMPL Windows or via the Crestron Viewport.

### Upload via SIMPL Windows

- Start SIMPL Windows.
- Select **File | Open** to view the “Open” window, navigate to the SIMPL Window file (.smw), and click **Open**.
- Select **Project | Transfer Program**.

### Upload via Crestron Viewport

- Verify that the procedure for “Communication Settings” that begins on page 33 has been performed.
- As shown after this step, select **File Transfer | Send Program** (alternatively, press **Alt+P**) from the Viewport menu.

#### File Transfer | Send Program Command

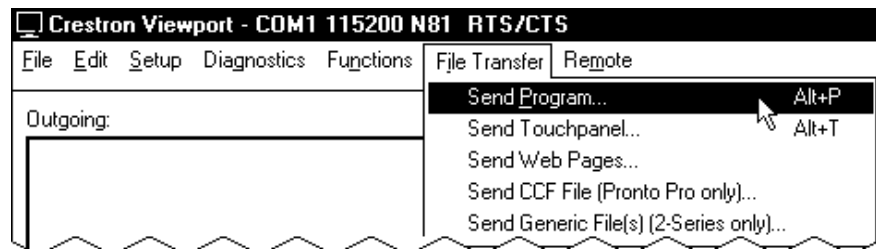

- The “Send Program” window appears, as shown after this step. Click **Browse**, locate the compiled file (.spz) and click **Open**. This will display the program's header information and enable one or both of the *What to Send* check boxes. If the program does not contain any SIMPL+ modules, only the *SIMPL Program* check box will be enabled. If it does contain SIMPL+ modules, then the *SIMPL+Program(s)* check box will also be enabled. Select one or both check boxes and then click **Send Program** to begin the transfer.

---

**NOTE:** Refer to the latest version of the Crestron 2-Series Control Systems Reference Guide (Doc. 6256) or the respective Operations Guide for the control system for details about the other fields shown on the “Send Program” window.

---

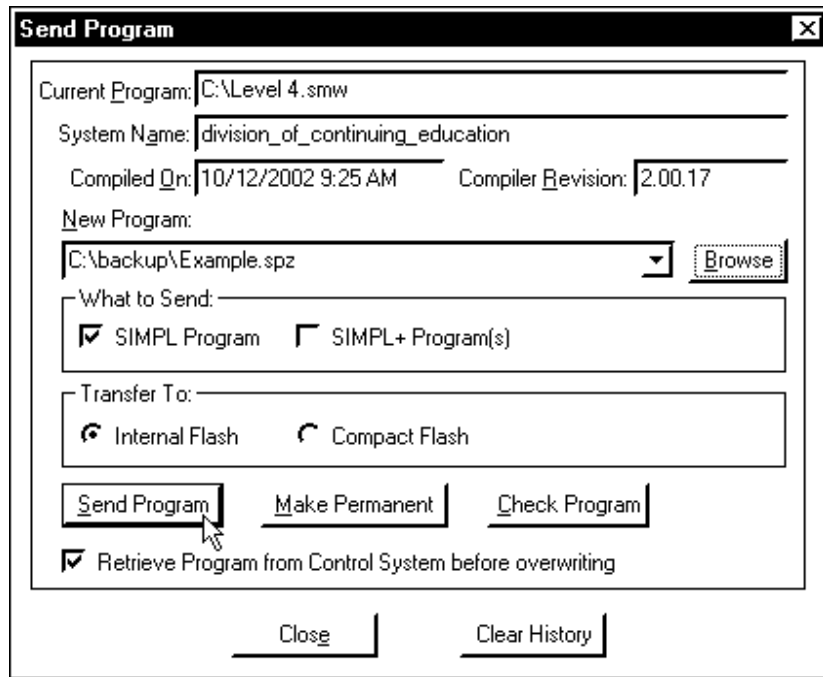

*“Send Program” Window*

- To verify that the program has been transferred successfully, select **Diagnostics | Report Program Information** or press **F7**. This should display a window that provides details about the current program loaded into the control system.

## Uploading a VT Pro-e Project

*The TPS-3100L touchpanel source file has the extension .vtp. A compiled VT Pro-e file has the extension .vtz.*

The VT Pro-e file can be uploaded to the touchpanel using VT Pro-e or via the Crestron Viewport.

### Upload via VT Pro-e

- Start VT Pro-e.
- Select **File | Open | Project** to view the “Open” window, navigate to the VT Pro-e file (.vtp), and click **Open**.
- Select **File | Upload Project**. This automatically selects the compiled .vtz file.

### Upload via Crestron Viewport

- Verify that the procedure for “Communication Settings” that begins on page 33 has been performed.
- As shown after this step, select **File Transfer | Send Touchpanel** (alternatively, press **Alt+T**) from the Viewport menu.

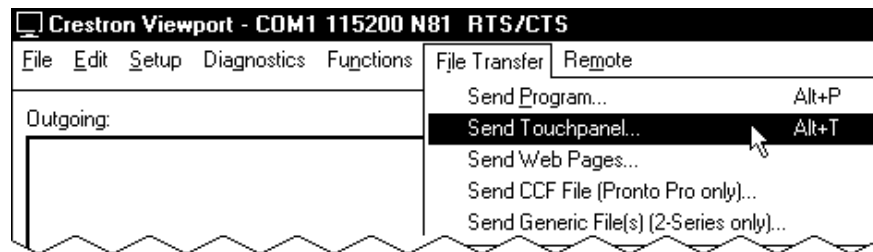
*File Transfer | Send Touchpanel Command*

- As shown after this step, select the Net ID of the TPS-3100L touchpanel and then click **OK**. The “Touch Panel Transfer” window appears (refer to the subsequent graphic).

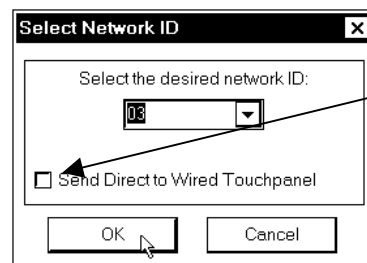
*“Select Network ID” Window*

Check *Send Direct to Wired Touchpanel* if connected via RS-232 directly to touchpanel.

---

**NOTE:** If problems occur when transferring any Cresnet file (touchpanel project/firmware), lower the port speed baud rate to 38400 to match the Cresnet bus speed when transferring through a control system.

---

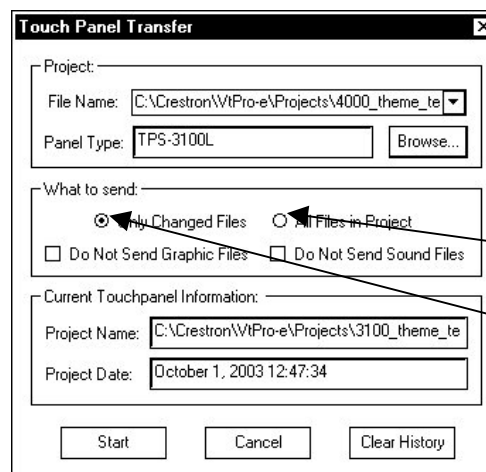
*“Touch Panel Transfer” Window*

Each time a project is selected using the **Browse** command, that project is added to the **File Name** drop-down list. This makes it convenient to recall projects without need to browse to a directory. To delete the list click **Clear History**.

**All Files in Project:** sends the entire project.

**Only Changed Files:** sends only the files that are different from those that are currently stored in the panel. Note that if any pages in the panel are not present in the project, those pages will be deleted from the panel.

Additional choices include **Do not send graphic files** and **Do not send sound files**. These are often very large files that take a long time to load.

- Click **Browse**. The “Open” window appears as shown in the following illustration.

*“Open” Window*

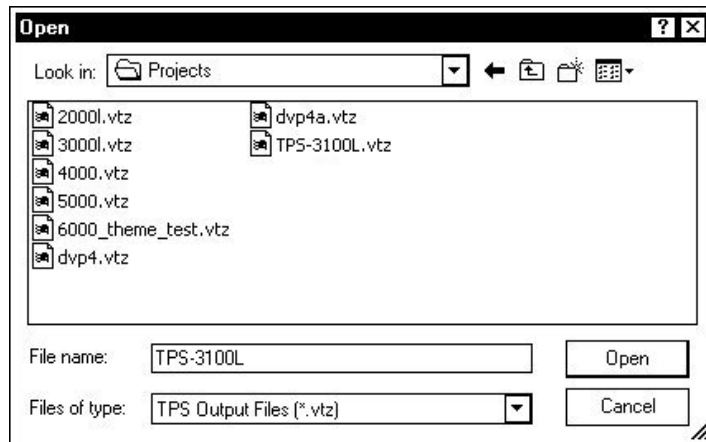

5. Select the VT Pro-e (.vtz) file and click **Open**. The transfer will complete automatically.

### Firmware Upgrade

*A firmware upgrade file has the extension .csf.*

To take advantage of all the TPS-3100L features, it is important that the unit contains the latest firmware available. Therefore, please check the Crestron website ([http://www.crestron.com/downloads/software\\_updates.asp](http://www.crestron.com/downloads/software_updates.asp)) for the latest version of firmware. Not every product has a firmware upgrade, but as Crestron improves functions, adds new features, and extends the capabilities of its products, firmware upgrades are posted. To upgrade the firmware, complete the following steps.

---

**NOTE:** The following is the acceptable file extension for a firmware update file:  
 .csf      *TPS.V.XXXXX.csf* (panel firmware)

---

1. Verify that the procedure for “Communication Settings” that begins on page 33 has been performed.
2. As shown after this step, select **File Transfer | Update Touchpanel Firmware** from the Viewport menu.

**File Transfer | Update Touchpanel Firmware Command**

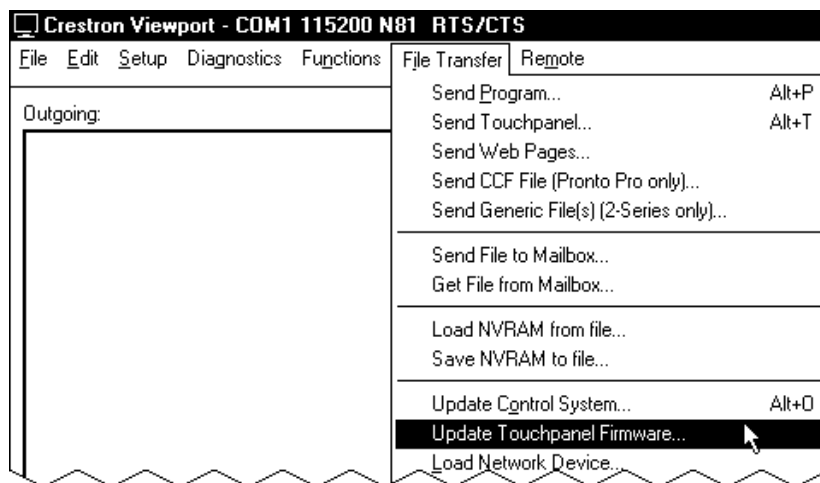

3. As shown after this step, select the Net ID of the TPS-3100L touchpanel and then click **OK**. The “Open” window appears (refer to the subsequent graphic).

*“Select Network ID” Window*

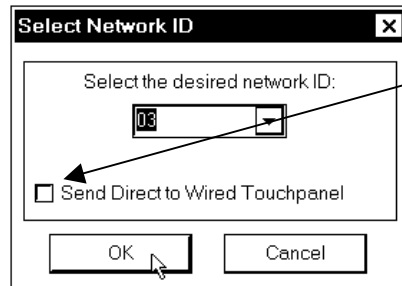

Check *Send Direct to Wired Touchpanel* if connected via RS-232 directly to touchpanel.

*Select CSF File*

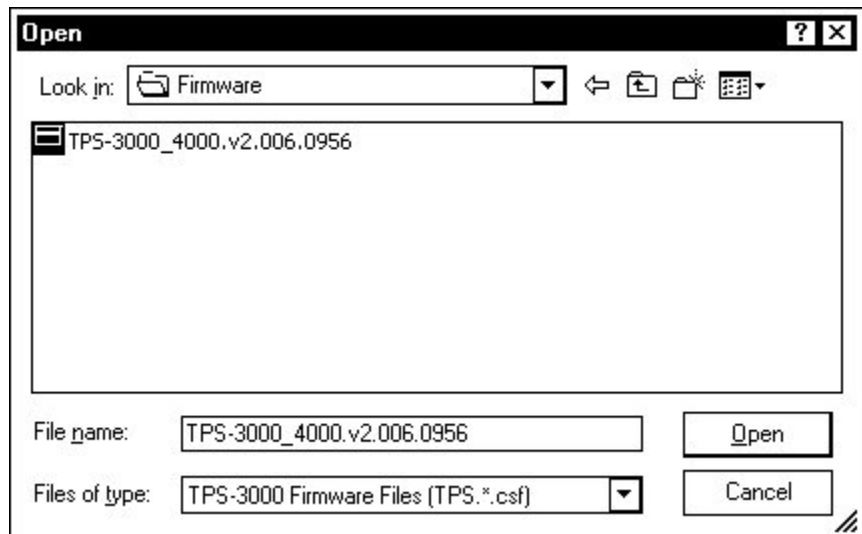

4. Browse to the .csf file and click **Open** to begin the transfer.

## Problem Solving

### Troubleshooting

The table after this paragraph provides corrective action for possible trouble situations. If further assistance is required, please contact a Crestron customer service representative.

#### *TPS-3100L Touchpanel Troubleshooting*

<b>TROUBLE</b>	<b>POSSIBLE CAUSE(S)</b>	<b>CORRECTIVE ACTION</b>
Touchpanel does not function.	Touchpanel is not communicating with the network.	Use Viewport (via SIMPL Windows or VT Pro-e) to poll the network. Verify network connection to the touchpanel.
	Touchpanel is not receiving network power.	Confirm that power is supplied to the network.
	Touchpanel is not receiving power from a Crestron power source.	Use a Crestron control system or an approved Crestron power supply.
	Touchpanel is incorrectly calibrated.	Enter "SETUP MODE" or use Viewport to put touchpanel into calibrate mode and recalibrate.
Touchpanel is not responding.	Incorrect network wiring.	Touch the screen to remove the message and verify correct wiring to all connectors.
	Touchpanel Cresnet ID is not set to match the Net ID in the SIMPL program.	Touch the screen to remove the message and enter Viewport (via SIMPL Windows or VT Pro-e) to poll the network. Verify that the Cresnet ID for the touchpanel is properly set to match the Net ID in the SIMPL program.
	Touchpanel Cresnet ID is not unique, two or more units share the same ID.	Enter Viewport (via SIMPL Windows or VT Pro-e) to poll the network and verify that each ID is used only once.
Touchpanel display is dark.	Standby timeout has elapsed.	Touch the screen to reactivate.
	Screen brightness is improperly set.	Enter "SETUP MODE" and alter screen brightness from the setup menu.
Unexpected response from the touchpanel.	Touchpanel is incorrectly calibrated.	Enter "SETUP MODE" or use Viewport to put touchpanel into calibrate mode and recalibrate.

*(continued on next page)*

*TPS-3100L Touchpanel Troubleshooting (continued)*

TROUBLE	POSSIBLE CAUSE(S)	CORRECTIVE ACTION
Blue Screen displayed in a video window.	Nonexistent or weak video signal.	Verify that video source is functioning and connected properly. Balanced video cable length should not exceed 500 feet (152.4 meters). Unbalanced video cable length should not exceed 100 feet (30.5 meters).
Touchpanel does not communicate with RS-232 devices.	Incorrect RS-232 settings.	Match communication settings of touchpanel to peripheral device.

## Further Inquiries

If after reviewing this Operations Guide, you cannot locate specific information or have questions, please take advantage of Crestron's award winning customer service team in your area. Dial one of the following numbers.

- In the US and Canada, call Crestron's corporate headquarters at 1-888-CRESTRON [1-888-273-7876].
- In Europe, call Crestron International at +32-15-50-99-50.
- In Asia, call Crestron Asia at +852-2341-2016.
- In Latin America, call Crestron Latin America at +5255-5093-2160.
- In Australia and New Zealand, call Crestron Control Solutions at +61-2-9737-8203.

You can also log onto the online help section of the Crestron website ([www.crestron.com](http://www.crestron.com)) to ask questions about Crestron products. First-time users will need to establish a user account to fully benefit from all available features.

## Future Updates

As Crestron improves functions, adds new features, and extends the capabilities of the TPS-3100L, additional information may be made available as manual updates. These updates are solely electronic and serve as intermediary supplements prior to the release of a complete technical documentation revision.

Check the Crestron website ([www.crestron.com](http://www.crestron.com)) periodically for manual update availability and its relevance. Updates are available from the Downloads | Product Manuals section and are identified as an "Addendum" in the Download column.

---

## Appendix: Configuring the RS-232 Port for Use

To configure the RS-232 port of the TPS-3100L, a local PC that contains a Crestron Viewport is required. The Viewport is one of the development tools that is part of Crestron SIMPL Windows or VT Pro-e software.

### Obtaining Communications

Refer to “Communication Settings” on page 33 for detailed instructions on connecting a PC to the touchpanel.

### Configuration Options

There are several RS-232 communication options (at the time of this printing, these were available):

- **CONSOLE** – console active on RS-232 port. Use to load programs, firmware, or to set configuration. This is the default. Use this configuration if no other option is appropriate.
- **TOUCHOUT** – touchscreen output sent to RS-232 port. Use for PC mouse control or Telestrator output. Directly connect computer or Telestrator box to RS-232 port on TPS-3100L (i.e., touch screen output). For example, use when an RGB window with tablet overlay on the TPS panel acts as a mouse controller for a PC. In this case, use the latest version of the Crestron Serial Mouse Control Driver, which can be downloaded from the Downloads | Software Updates section of the Crestron website ([www.crestron.com](http://www.crestron.com)). Another use is with the Pointmaker® telestrator. For details, refer to the Telestrator Integration Guide, which can be downloaded from the Downloads | Product Manuals section of the Crestron website ([www.crestron.com](http://www.crestron.com)).
- **EXT\_TOUCH** – RS-232 port used for external touch screen input (i.e., SMART Matisse Overlay or Microtouch Display).

### RS-232 Port Configuration

After establishing communication with the control system, the RS-232 can now be configured for communication with an option. Complete the following steps in the order provided.

1. From the Viewport, select **Remote | Remote Console | Connect**.
2. From the “TPS>” prompt, enter the following command:

```
rs232 ?
```

3. The TPS-3100L responds with the following:

```
RS232MODE [CONSOLE|CONTROL|RF|TOUCHOUT|MOUSE|EXT_TOUCH]
CONSOLE - console active on RS232 port
TOUCHOUT - touchscreen output sent to RS232 port.
EXT_TOUCH - rs232 port used for ext. touchscreen input
No parameter - display current setting
```

4. Enter a command that chooses one of the RS-232 communication options. Use the same spelling as shown in the last touchpanel response.

5. The TPS-3100L responds with the following:

```
New RS232mode set. Reboot to take effect.
```

6. Enter the following command:

```
reboot
```

7. The TPS-3100L responds with the following:

```
Rebooting system. Please wait.
```

8. From the Viewport, select **Remote | Remote Console | Disconnect**.

At this point, the PC and the TPS-3100L are no longer communicating. Assuming that the touchpanel is properly connected for use (as shown in the diagram for “Communication Settings” on page 33) and the control system is connected to the PC, the setup screens can be displayed to set the Net ID and other configurations.

---

**NOTE:** Alternatively, use a Cresnet command from the Viewport (communicating to the control system) to access the setup screens. Verify the Net ID of the TPS-3100L and select **Functions | Put Touch Panel into Setup Mode**. Enter the Net ID and click **OK**.

---



---

## Software License Agreement

This License Agreement ("Agreement") is a legal contract between you (either an individual or a single business entity) and Crestron Electronics, Inc. ("Crestron") for software referenced in this guide, which includes computer software and, as applicable, associated media, printed materials, and "online" or electronic documentation (the "Software").

BY INSTALLING, COPYING, OR OTHERWISE USING THE SOFTWARE, YOU REPRESENT THAT YOU ARE AN AUTHORIZED DEALER OF CRESTRON PRODUCTS OR A CRESTRON AUTHORIZED INDEPENDENT PROGRAMMER AND YOU AGREE TO BE BOUND BY THE TERMS OF THIS AGREEMENT. IF YOU DO NOT AGREE TO THE TERMS OF THIS AGREEMENT, DO NOT INSTALL OR USE THE SOFTWARE.

IF YOU HAVE PAID A FEE FOR THIS LICENSE AND DO NOT ACCEPT THE TERMS OF THIS AGREEMENT, CRESTRON WILL REFUND THE FEE TO YOU PROVIDED YOU (1) CLICK THE DO NOT ACCEPT BUTTON, (2) DO NOT INSTALL THE SOFTWARE AND (3) RETURN ALL SOFTWARE, MEDIA AND OTHER DOCUMENTATION AND MATERIALS PROVIDED WITH THE SOFTWARE TO CRESTRON AT: CRESTRON ELECTRONICS, INC., 15 VOLVO DRIVE, ROCKLEIGH, NEW JERSEY 07647, WITHIN 30 DAYS OF PAYMENT.

### LICENSE TERMS

Crestron hereby grants You and You accept a nonexclusive, nontransferable license to use the Software (a) in machine readable object code together with the related explanatory written materials provided by Crestron (b) on a central processing unit ("CPU") owned or leased or otherwise controlled exclusively by You, and (c) only as authorized in this Agreement and the related explanatory files and written materials provided by Crestron.

If this software requires payment for a license, you may make one backup copy of the Software, provided Your backup copy is not installed or used on any CPU. You may not transfer the rights of this Agreement to a backup copy unless the installed copy of the Software is destroyed or otherwise inoperable and You transfer all rights in the Software.

You may not transfer the license granted pursuant to this Agreement or assign this Agreement without the express written consent of Crestron.

If this software requires payment for a license, the total number of CPU's on which all versions of the Software are installed may not exceed one per license fee (1) and no concurrent, server or network use of the Software (including any permitted back-up copies) is permitted, including but not limited to using the Software (a) either directly or through commands, data or instructions from or to another computer (b) for local, campus or wide area network, internet or web hosting services; or (c) pursuant to any rental, sharing or "service bureau" arrangement.

The Software is designed as a software development and customization tool. As such Crestron cannot and does not guarantee any results of use of the Software or that the Software will operate error free and You acknowledge that any development that You perform using the Software or Host Application is done entirely at Your own risk.

The Software is licensed and not sold. Crestron retains ownership of the Software and all copies of the Software and reserves all rights not expressly granted in writing.

### OTHER LIMITATIONS

You must be an Authorized Dealer of Crestron products or a Crestron Authorized Independent Programmer to install or use the Software. If Your status as a Crestron Authorized Dealer or Crestron Authorized Independent Programmer is terminated, Your license is also terminated.

You may not rent, lease, lend, sublicense, distribute or otherwise transfer or assign any interest in or to the Software.

You may not reverse engineer, decompile, or disassemble the Software.

You agree that the Software will not be shipped, transferred or exported into any country or used in any manner prohibited by the United States Export Administration Act or any other export laws, restrictions or regulations ("Export Laws"). By downloading or installing the Software You (a) are certifying that You are not a national of Cuba, Iran, Iraq, Libya, North Korea, Sudan, or Syria or any country to which the United States embargoes goods (b) are certifying that You are not otherwise prohibited from receiving the Software and (c) You agree to comply with the Export Laws.

If any part of this Agreement is found void and unenforceable, it will not affect the validity of the balance of the Agreement, which shall remain valid and enforceable according to its terms. This Agreement may only be modified by a writing signed by an authorized officer of Crestron. Updates may be licensed to You by Crestron with additional or different terms. This is the entire agreement between Crestron and You relating to the Software and it supersedes any prior representations, discussions, undertakings, communications or advertising relating to the Software. The failure of either party to enforce any right or take any action in the event of a breach hereunder shall constitute a waiver unless expressly acknowledged and set forth in writing by the party alleged to have provided such waiver.

If You are a business or organization, You agree that upon request from Crestron or its authorized agent, You will within thirty (30) days fully document and certify that use of any and all Software at the time of the request is in conformity with Your valid licenses from Crestron or its authorized agent.

Without prejudice to any other rights, Crestron may terminate this Agreement immediately upon notice if you fail to comply with the terms and conditions of this Agreement. In such event, you must destroy all copies of the Software and all of its component parts.

#### PROPRIETARY RIGHTS

*Copyright.* All title and copyrights in and to the Software (including, without limitation, any images, photographs, animations, video, audio, music, text, and “applets” incorporated into the Software), the accompanying media and printed materials, and any copies of the Software are owned by Crestron or its suppliers. The Software is protected by copyright laws and international treaty provisions. Therefore, you must treat the Software like any other copyrighted material, subject to the provisions of this Agreement.

*Submissions.* Should you decide to transmit to Crestron’s website by any means or by any media any materials or other information (including, without limitation, ideas, concepts or techniques for new or improved services and products), whether as information, feedback, data, questions, comments, suggestions or the like, you agree such submissions are unrestricted and shall be deemed non-confidential and you automatically grant Crestron and its assigns a non-exclusive, royalty-free, worldwide, perpetual, irrevocable license, with the right to sublicense, to use, copy, transmit, distribute, create derivative works of, display and perform the same.

*Trademarks.* CRESTRON and the Swirl Logo are registered trademarks of Crestron Electronics, Inc. You shall not remove or conceal any trademark or proprietary notice of Crestron from the Software including any back-up copy.

#### GOVERNING LAW

This Agreement shall be governed by the laws of the State of New Jersey, without regard to conflicts of laws principles. Any disputes between the parties to the Agreement shall be brought in the state courts in Bergen County, New Jersey or the federal courts located in the District of New Jersey. The United Nations Convention on Contracts for the International Sale of Goods, shall not apply to this Agreement.

#### CRESTRON LIMITED WARRANTY

CRESTRON warrants that: (a) the Software will perform substantially in accordance with the published specifications for a period of ninety (90) days from the date of receipt, and (b) that any hardware accompanying the Software will be subject to its own limited warranty as stated in its accompanying written material. Crestron shall, at its option, repair or replace or refund the license fee for any Software found defective by Crestron if notified by you within the warranty period. The foregoing remedy shall be your exclusive remedy for any claim or loss arising from the Software.

CRESTRON shall not be liable to honor warranty terms if the product has been used in any application other than that for which it was intended, or if it as been subjected to misuse, accidental damage, modification, or improper installation procedures. Furthermore, this warranty does not cover any product that has had the serial number or license code altered, defaced, improperly obtained, or removed.

Notwithstanding any agreement to maintain or correct errors or defects Crestron, shall have no obligation to service or correct any error or defect that is not reproducible by Crestron or is deemed in Crestron’s reasonable discretion to have resulted from (1) accident; unusual stress; neglect; misuse; failure of electric power, operation of the Software with other media not meeting or not maintained in accordance with the manufacturer’s specifications; or causes other than ordinary use; (2) improper installation by anyone other than Crestron or its authorized agents of the Software that deviates from any operating procedures established by Crestron in the material and files provided to You by Crestron or its authorized agent; (3) use of the Software on unauthorized hardware; or (4) modification of, alteration of, or additions to the Software undertaken by persons other than Crestron or Crestron’s authorized agents.

ANY LIABILITY OF CRESTRON FOR A DEFECTIVE COPY OF THE SOFTWARE WILL BE LIMITED EXCLUSIVELY TO REPAIR OR REPLACEMENT OF YOUR COPY OF THE SOFTWARE WITH ANOTHER COPY OR REFUND OF THE INITIAL LICENSE FEE CRESTRON RECEIVED FROM YOU FOR THE DEFECTIVE COPY OF THE PRODUCT. THIS WARRANTY SHALL BE THE SOLE AND EXCLUSIVE REMEDY TO YOU. IN NO EVENT SHALL CRESTRON BE LIABLE FOR INCIDENTAL, CONSEQUENTIAL, SPECIAL OR PUNITIVE DAMAGES OF ANY KIND (PROPERTY OR ECONOMIC DAMAGES INCLUSIVE), EVEN IF A CRESTRON REPRESENTATIVE HAS BEEN ADVISED OF THE POSSIBILITY OF SUCH DAMAGES OR OF ANY CLAIM BY ANY THIRD PARTY. CRESTRON MAKES NO WARRANTIES, EXPRESS OR IMPLIED, AS TO TITLE OR INFRINGEMENT OF THIRD-PARTY RIGHTS, MERCHANTABILITY OR FITNESS FOR ANY PARTICULAR PURPOSE, OR ANY OTHER WARRANTIES, NOR AUTHORIZES ANY OTHER PARTY TO OFFER ANY WARRANTIES, INCLUDING WARRANTIES OF MERCHANTABILITY FOR THIS PRODUCT. THIS WARRANTY STATEMENT SUPERSEDES ALL PREVIOUS WARRANTIES.

---

## Return and Warranty Policies

### Merchandise Returns / Repair Service

1. No merchandise may be returned for credit, exchange, or service without prior authorization from CRESTRON. To obtain warranty service for CRESTRON products, contact the factory and request an RMA (Return Merchandise Authorization) number. Enclose a note specifying the nature of the problem, name and phone number of contact person, RMA number, and return address.
2. Products may be returned for credit, exchange, or service with a CRESTRON Return Merchandise Authorization (RMA) number. Authorized returns must be shipped freight prepaid to CRESTRON, 6 Volvo Drive, Rockleigh, N.J., or its authorized subsidiaries, with RMA number clearly marked on the outside of all cartons. Shipments arriving freight collect or without an RMA number shall be subject to refusal. CRESTRON reserves the right in its sole and absolute discretion to charge a 15% restocking fee, plus shipping costs, on any products returned with an RMA.
3. Return freight charges following repair of items under warranty shall be paid by CRESTRON, shipping by standard ground carrier. In the event repairs are found to be non-warranty, return freight costs shall be paid by the purchaser.

### CRESTRON Limited Warranty

CRESTRON ELECTRONICS, Inc. warrants its products to be free from manufacturing defects in materials and workmanship under normal use for a period of three (3) years from the date of purchase from CRESTRON, with the following exceptions: disk drives and any other moving or rotating mechanical parts, pan/tilt heads and power supplies are covered for a period of one (1) year; touchscreen display and overlay components are covered for 90 days; batteries and incandescent lamps are not covered.

This warranty extends to products purchased directly from CRESTRON or an authorized CRESTRON dealer. Purchasers should inquire of the dealer regarding the nature and extent of the dealer's warranty, if any.

CRESTRON shall not be liable to honor the terms of this warranty if the product has been used in any application other than that for which it was intended, or if it has been subjected to misuse, accidental damage, modification, or improper installation procedures. Furthermore, this warranty does not cover any product that has had the serial number altered, defaced, or removed.

This warranty shall be the sole and exclusive remedy to the original purchaser. In no event shall CRESTRON be liable for incidental or consequential damages of any kind (property or economic damages inclusive) arising from the sale or use of this equipment. CRESTRON is not liable for any claim made by a third party or made by the purchaser for a third party.

CRESTRON shall, at its option, repair or replace any product found defective, without charge for parts or labor. Repaired or replaced equipment and parts supplied under this warranty shall be covered only by the unexpired portion of the warranty.

Except as expressly set forth in this warranty, CRESTRON makes no other warranties, expressed or implied, nor authorizes any other party to offer any warranty, including any implied warranties of merchantability or fitness for a particular purpose. Any implied warranties that may be imposed by law are limited to the terms of this limited warranty. This warranty statement supercedes all previous warranties.

#### Trademark Information

*All brand names, product names, and trademarks are the sole property of their respective owners. Windows is a registered trademark of Microsoft Corporation. Windows95/98/Me/XP and WindowsNT/2000 are trademarks of Microsoft Corporation.*



**Crestron Electronics, Inc.**  
15 Volvo Drive Rockleigh, NJ 07647  
Tel: 888.CRESTRON  
Fax: 201.767.7576  
[www.crestron.com](http://www.crestron.com)

---

**Operations Guide – DOC. 6291**  
**10.04**

Specifications subject to  
change without notice.