

Crestron **MPS-200**
Multimedia Presentation System 200

Operations Guide



This document was prepared and written by the Technical Documentation department at:



Crestron Electronics, Inc.
15 Volvo Drive
Rockleigh, NJ 07647
1-888-CRESTRON

Important Safety Instructions

- Read these instructions.
- Keep these instructions.
- Heed all warnings.
- Follow all instructions.
- Do not use this apparatus near water.
- Clean only with dry cloth.
- Do not block any ventilation openings. Install in accordance with the manufacturer's instructions.
- Do not install near any heat sources such as radiators, heat registers, stoves, or other apparatus (including amplifiers) that produce heat.
- Do not defeat the safety purpose of the polarized or grounding-type plug. A polarized plug has two blades with one wider than the other. A grounding-type plug has two blades and a third grounding prong. The wide blade or the third prong are provided for your safety. If the provided plug does not fit into your outlet, consult an electrician for replacement of the obsolete outlet.
- Protect the power cord from being walked on or pinched particularly at plugs, convenience receptacles, and the point where they exit from the apparatus.
- Only use attachments/accessories specified by the manufacturer.
- Unplug this apparatus during lightning storms or when unused for long periods of time.
- Refer all servicing to qualified service personnel. Servicing is required when the apparatus has been damaged in any way, such as power-supply cord or plug is damaged, liquid has been spilled or objects have fallen into the apparatus, the apparatus has been exposed to rain or moisture, does not operate normally, or has been dropped.
- Disconnect power prior to connecting or disconnecting equipment.
- Do not install in direct sunlight.
- The apparatus must be installed in a way that the power cord can be removed either from the wall outlet or from the device itself in order to disconnect the mains power.
- Prevent foreign objects from entering the device.

WARNING:

TO REDUCE THE RISK OF FIRE OR ELECTRIC SHOCK, DO NOT EXPOSE THIS APPARATUS TO RAIN OR MOISTURE. THE APPARATUS SHALL NOT BE EXPOSED TO DRIPPING OR SPLASHING. OBJECTS FILLED WITH LIQUIDS, SUCH AS VASES, SHOULD NOT BE PLACED ON THE APPARATUS.

WARNING:

TO PREVENT ELECTRIC SHOCK, DO NOT REMOVE COVER. THERE ARE NO USER SERVICEABLE PARTS INSIDE. ONLY QUALIFIED SERVICE PERSONNEL SHOULD PERFORM SERVICE.



AVIS: RISQUE DE CHOC ELECTRIQUE NE PAS OUVRIIR



The lightning flash with arrowhead symbol, within an equilateral triangle, is intended to alert the user to the presence of uninsulated "dangerous voltage" within the product's enclosure that may be of sufficient magnitude to constitute a risk of electric shock to persons.



The exclamation point within an equilateral triangle is intended to alert the user to the presence of important operating and maintenance (servicing) instructions in the literature accompanying the appliance.

WARNING:

THIS IS AN APPARATUS WITH CLASS I CONSTRUCTION. IT SHALL BE CONNECTED TO AN ELECTRICAL OUTLET WITH AN EARTHING GROUND TERMINAL.

IMPORTANT:

The MPS-200 can be used with Class 2 output wiring.

Contents

Multimedia Presentation System 200: MPS-200	1
Introduction	1
Features and Functions	1
Applications.....	4
Internal Block Diagram	5
Specifications	6
Physical Description	10
Industry Compliance	20
Setup.....	21
Network Wiring.....	21
Ethernet	21
CAT5 Wiring.....	21
QuickMedia Wiring.....	22
Installation.....	23
Hardware Hookup	24
Configure the RGB Input Ports	27
Programming Software.....	30
Earliest Version Software Requirements for the PC	30
Programming with Crestron SystemBuilder.....	30
Programming with SIMPL Windows	31
Switching Programs.....	32
Saving Settings.....	32
Example Program	32
Uploading and Upgrading.....	33
Establishing Communication.....	33
Programs and Firmware	34
Configuration & Operation	35
Configuration.....	35
Operation.....	74
Problem Solving	82
Troubleshooting.....	82
Check Network Wiring.....	84
Reference Documents.....	85
Further Inquiries	86
Future Updates	86
Software License Agreement.....	87
Return and Warranty Policies.....	89
Merchandise Returns / Repair Service	89
CRESTRON Limited Warranty.....	89

Multimedia Presentation System 200: MPS-200

Introduction

Features and Functions

- System switcher, audio processor, and control system
- Out-of-the-box switching and audio control
- Four video/HDTV and four RGB/computer inputs
- Built-in input signal sensing | auto-switching capable
- Separate display and touchpanel preview outputs
- QuickMedia™ and Crestron Home® CAT5 AV connectivity
- Eight balanced stereo audio inputs | Two gated mic inputs
- Discrete program, speech, and record outputs
- 12-band parametric/graphic equalization and delay
- Built-in 40 watt amplifier — stereo, 70V, or 100V models available
- 2-Series control engine | e-Control®2 Web server
- 10/100 Ethernet | RoomView® and SNMP support
- Two RS-232, four IR, four digital in, & four relay control ports
- Front panel setup and control | Backlit LCD display
- Keypad, touchpanel, and wireless control options
- Internal power supply | two-space rack-mountable

The MPS-200 is a complete presentation control and signal routing solution for boardrooms and classrooms. Integrating the control system, multimedia switcher, audio processor, and amplifier into a single two-space rack mount package, the MPS-200 eliminates the need for separate components without forfeiting performance or flexibility.

System Switcher

The MPS-200 provides switching of four video and four RGB computer sources to a single projector or plasma display. Composite, S-video, component and RGBHV signals can be routed to the appropriate inputs on the display device, with control of the display provided via Ethernet, RS-232 or IR. Input signal sensing on every video and RGB input enables auto-switching functionality and provides device power

status information to the control system. Selectable sync impedance on the RGB inputs helps accommodate cable runs of varying lengths.

Touchpanel Output

A second discrete output is provided on the MPS-200 to feed a preview signal to the system touchpanel or other monitor. This output is controlled separately from the main display output, allowing a different source to be viewed. The touchpanel output provides a choice of QuickMedia™ (QM) or Crestron Home (CH) CAT5 balanced video connections, simplifying wiring to a wide range of Crestron® touchpanels. The QM output supports high-resolution RGB and HDTV plus audio, while the CH output is limited to standard video and HDTV only (dependent upon the capabilities of the touchpanel). RGBHV inputs are only displayed on the QM output.

QuickMedia

The QM touchpanel output can also be used to feed signals straight to the primary display device, providing a very streamlined, low-cost, long-distance wiring solution. Crestron's QuickMedia transport transmits high-resolution RGB, HD video, stereo program and microphone audio signals up to 450 feet over a single inexpensive CAT5e type cable. Just one CresCAT-QM cable and a QM receiver are all that is required for complete signal routing and device control, eliminating all the bulky, expensive cabling that would otherwise be needed.

Audio Features

Eight stereo audio inputs accept balanced or unbalanced line-level signals from computers and other program audio sources. To accommodate a wide range of signals, adjustable input compensation is used to maintain consistent volume levels when switching between sources. In addition to the eight program inputs, two gated microphone/line inputs are included with software-switchable 48V phantom power and independent four-band speech-optimized equalization. Matrix mixing allows the selected program signal and the microphone signals to be separated or mixed in any combination to feed three “local” outputs, each with its own unique mix.

Three discrete balanced line level outputs are provided, each with independent adjustments for volume, bass, treble, and mute. The stereo program (**PROG OUT**) and mono speech (**SPEECH**) outputs are normally intended for driving external amplification, with relay muting on each output to prevent “thumping” on power up. The record (**REC OUT**) output allows for a completely separate stereo mix to feed a codec, recording device, or assistive listening system. Ten-band graphic equalization plus 2-band parametric equalization on each output eliminates the need for expensive outboard audio processors, and up to 40 ms delay adjustment is available on the **SPEECH** output for proper loudspeaker alignment.

The QM touchpanel output is controlled separately from the other audio outputs, allowing a different program source and microphone mix to be monitored on the touchpanel, or output to other audio equipment by way of an appropriate QM receiver or other QuickMedia device.

Built-in Amplifier

A 40-watt amplifier (20 watts x2) is built into the MPS-200, with three models available offering the choice of 8-ohm stereo (MPS-200), 70V mono (MPS-200-70V), or 100V mono (MPS-200-100V) outputs. The term “MPS-200” is used throughout this guide to denote all models. For larger rooms requiring more power, the MPS-200 supports plug-and-play compatibility with Crestron's QM-Series 3-channel amplifiers, providing a complete solution for driving a professional loudspeaker system with discrete program and speech channels.

Front Panel Control

Out of the box, the MPS-200 front panel supports easy pushbutton routing of input sources to each of the outputs, and audio volume adjustment using the volume control knob. Dedicated buttons and indicators are also provided for separate control of system power and projector power. In addition, five preset buttons are included for custom functions such as lowering a projection screen, closing blinds, or selecting a lighting preset.

The front panel label strips can be customized using Crestron Engraver software or standard 3/8" tape labels, allowing for the clear designation of each input, output, and preset button. When selected, these functions will also appear on the LCD display as generic names (Input 1, 2, etc.), or as custom names (DVD, Podium PC, Screen Up, etc.) which are easily entered using MediaManager Wizard software.

Setup can be accomplished using the LCD front panel; a computer is not needed. Together with four softkey buttons, four menu navigation buttons and the volume knob, the LCD enables configuration of IP network, audio, and other system settings. For security, the front panel controls can be password protected or locked out.

2-Series Control System

Integrated into the MPS-200 is a Crestron 2-Series Ethernet control system with e-Control^{®2} Web server and a host of RS-232, IR, digital input and relay control ports for integration with third-party equipment. A basic AV presentation room with projector, screen, keypad or small touchpanel, and wireless remote control can be set up with MediaManager Wizard software. Or, a custom system can be programmed using SystemBuilder[™] or SIMPL[™] Windows[®] software. Either way, the MPS-200 works with Crestron's RoomView help desk software, the industry's most comprehensive facility-wide asset management solution.

Room Control Options

Without requiring any programming, the MPS-200 can be controlled using Crestron's APAD LCD Controller or a selection of keypads such as the C2N-DB12, CNX-B12, and C2N-FTB. With custom programming, Crestron's complete line of Isys[®] touchpanels and MediaManager FlipTops are supported. Equipped with an optional CNXRMIRD IR receiver, the MPS-200 allows any Crestron IR wireless touchpanel or third-party universal remote to be used for a low-cost wireless control solution. Or, adding an RF wireless gateway, infiNET[™], or WiFi wireless LAN connection enables use of a wide range of one-way and two-way RF wireless handheld remotes and touchpanels.

Applications

The following diagram shows an MPS-200 in a lecture hall application.

MPS-200 in a Lecture Hall Application

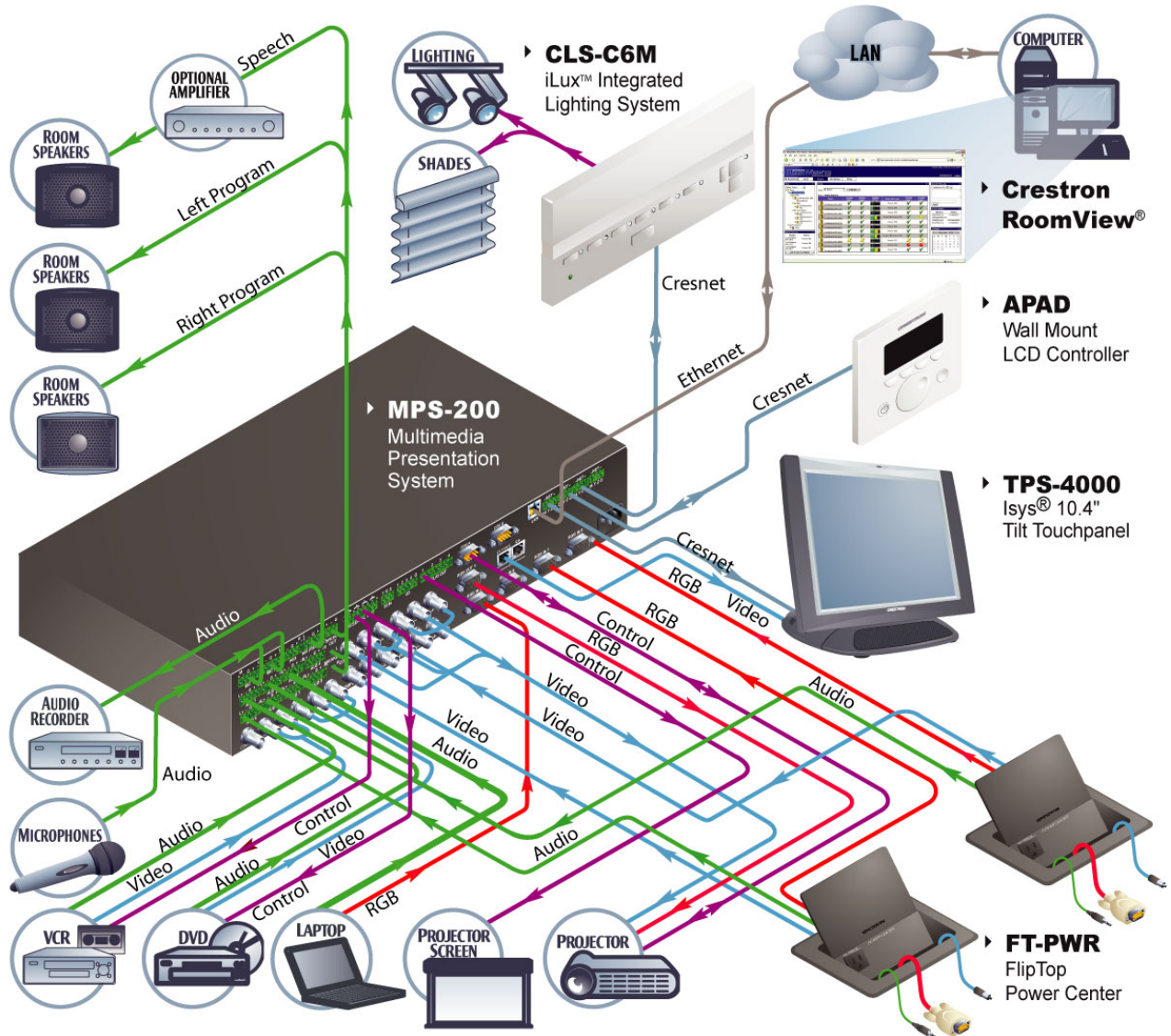

For more information on this and other QM applications, refer to the latest revision of the Crestron MediaManager Applications Guide (Doc. 6244), which is available from the Crestron website (<http://www.crestron.com/manuals>).

Internal Block Diagram

The following diagrams represent the video and audio switching abilities of the MPS-200. For more information refer to “Configuration ” on page 35.

Video Block Diagram of the MPS-200

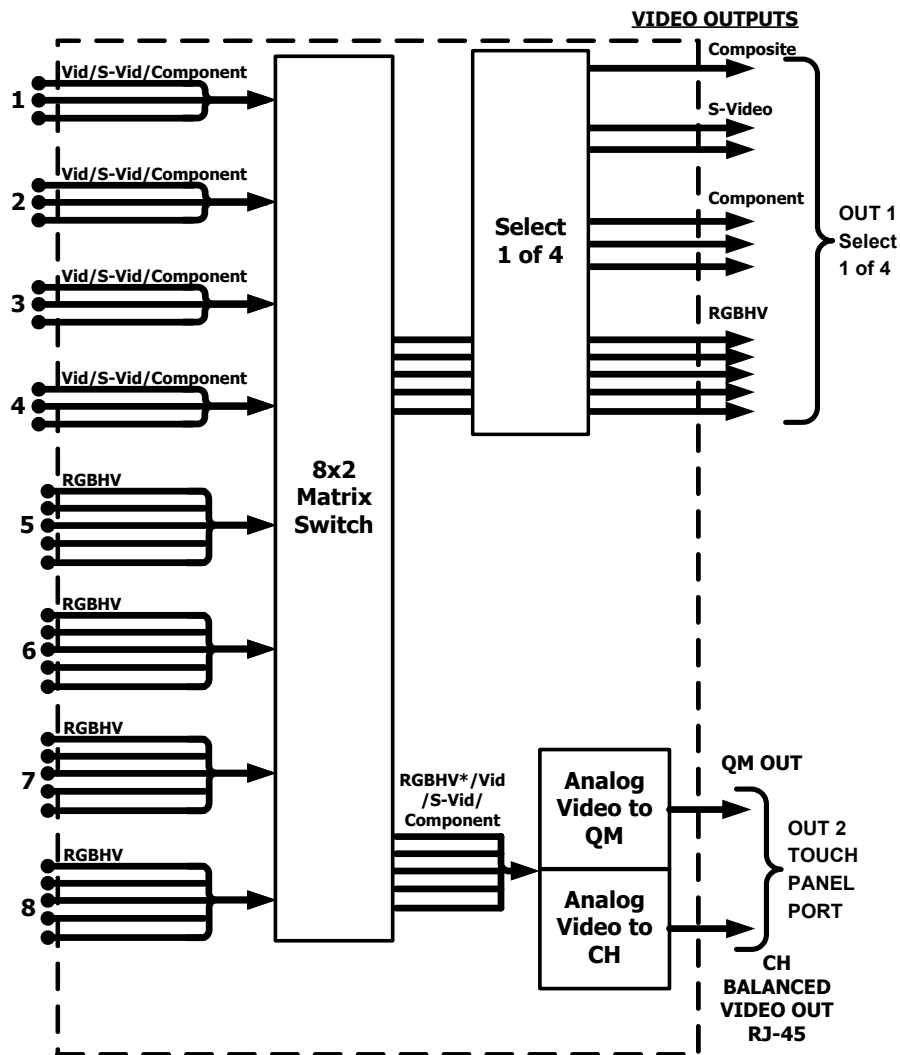

* RGBHV on **QM OUT** only.

The signal type routed to **OUT 1** is the same as the input signal type. For example, an S-video input signal will appear on the S-video output terminals when the signal is routed to **OUT 1**. The MPS-200 does not convert input signal formats.

Audio Block Diagram of the MPS-200

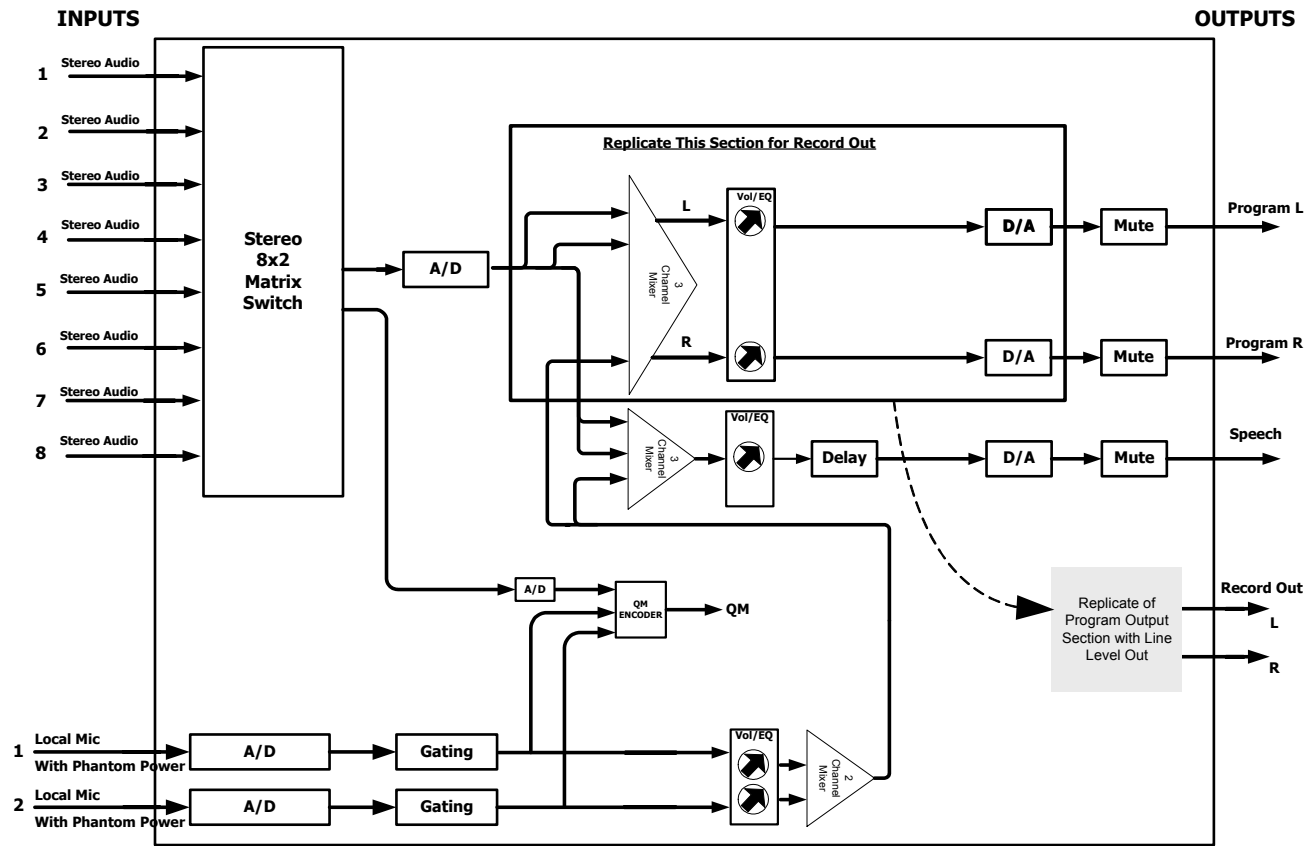

Specifications

Specifications for the MPS-200 are listed in the following table.

MPS-200 Specifications

SPECIFICATION	DETAILS
Processor CPU	32-bit Freescale ColdFire [®] Microprocessor
Memory SDRAM	32 MB
NVRAM	256 KB
Flash	16 MB
Operating System	Real-time, preemptive, multitasking kernel, multi-threaded, FAT32 file system with long names; supports SIMPL Windows and SIMPL+ [®]
Ethernet	10/100BaseT, static IP or DHCP/DNS, SSL, auto-negotiating, full duplex TCP/IP, UDP/IP, CIP, SMTP, SNMP, built-in Web server and e-mail client; supports Crestron e-Control [®] 2 XPanel and RoomView [®] applications

(Continued on following page)

MPS-200 Specifications (Continued)

SPECIFICATION	DETAILS
Video/RGB	
Switcher	8x2(x5) crosspoint matrix, 1x4 video/RGB output selector
Signal Types	RGB and composite, S-video, or component video (does not transcode)
Video/HDTV Formats	NTSC or PAL, HDTV up to 1080i/1080p
RGB Formats	RGBHV or RGBS
Maximum Resolution	QXGA 2048 X 1536 @ 60Hz (WUXGA 1920 X 1200 @ 60Hz via QM)
Blanking Time	< 0.1 second
Sync Rise/Fall Time	3.5 ns maximum
Sync Latency	< 30 ns
Gain	0dB (75 ohms terminated)
Audio	
Switcher/Preamp	8x2 stereo crosspoint matrix, 2-channel gated mic preamp w/EQ, 4x5 mic/program matrix mixer, stereo volume/tone control and EQ per each of PROGRAM and RECORD outputs, mono volume/tone control and EQ/delay on SPEECH output, integrated power amplifier
A-D/D-A Conversion	24-bit, 48 kHz
Output Volume Range	-80dB to +20dB, 0.1dB steps
Mixer Volume Range	-80dB to 0dB, 0.1dB steps
Mute	-100dB (electronic), -120dB (relay)
Input Compensation	±10dB, 0.1dB steps
Mic Input Gain	0 to 100% (40dB range) plus mute
Gate Level (Threshold)	0 to 100%
Attack	0 to 100 ms
Decay (Release)	0 to 5000 ms
Microphone EQ Filter Gain	±12dB, 0.1dB steps
Mic EQ Filter Center Frequencies	160, 500, 1.2k, 3k Hz
Bass Gain Range	±12dB @ 100Hz, 0.5dB steps
Treble Gain Range	±12dB @ 10kHz, 0.5dB steps
Output Equalization	10-band graphic + 2-band parametric
PEQ Filter Gain	±12dB, 0.1 dB steps
PEQ Filter Bandwidth	0.1 to 3.0 octaves, 0.1 octave steps
PEQ Filter Center Frequency	25Hz to 20kHz, 0.5Hz steps
PEQ Filter Types	Low Pass, High Pass, Peaking Eq, Notch, Treble Shelf, Bass Shelf

(Continued on following page)

MPS-200 Specifications (Continued)

SPECIFICATION	DETAILS
Audio (continued) GEQ Filter Gain GEQ Filter Center Frequencies Speech Output Delay Frequency Response PROG/REC OUT SPEECH OUT SPEAKER (8 ohms) SPEAKER (70V or 100V) S/N Ratio PROG/REC OUT SPEECH OUT SPEAKER (8 ohms) SPEAKER (70V or 100V) THD+N PROG/REC OUT SPEECH OUT SPEAKER (8 ohms) SPEAKER (70V or 100V) Stereo Separation PROG/REC OUT SPEAKER (8 ohms) Channel Crosstalk	±12dB, 0.1dB steps 31.5, 63, 125, 250, 500, 1k, 2k, 4k, 8k, 16k Hz 0 to 40 ms, 1 ms steps 20Hz to 20kHz ±0.5dB 50Hz to 20kHz ±0.5dB 20Hz to 20kHz ±0.5dB 100Hz to 20kHz ±1.5dB 90dB (@ 10dBV, 20Hz to 20kHz A-weighted) 90dB (@ 10dBV, 50Hz to 20kHz A-weighted) 90dB (full output, 20Hz to 20kHz A-weighted) 90dB (full output, 20Hz to 20kHz A-weighted) 0.05% (@ 10dBV, 20Hz to 20kHz) 0.05% (@ 10dBV, 50Hz to 20kHz) 0.7% (full output, 20Hz to 20kHz) 0.7% (full output, 100Hz to 20kHz A-weighted) -75dB (@ 10dBV, 20Hz to 20kHz) -60dB (full output, 20Hz to 20kHz) -70dB (AUD IN @ 10dBV, 20Hz to 20kHz)
LCD Display	Green LCD alphanumeric, adjustable backlight. Two lines x 20 characters per line. Displays input/outputs by name, volume level bargraph, setup menus, time/date, and other system information
Power Requirements Main Power Available Cresnet Power	2.5 Amps @ 100-240 Volts AC, 50/60 Hz 30 Watts
Environmental Temperature Humidity	41° to 104°F (5° to 40°C) 10% to 90% RH (non-condensing)

(Continued on following page)

MPS-200 Specifications (Continued)

SPECIFICATION	DETAILS
Enclosure Chassis Faceplate Mounting	Steel, black matte powder coat finish, convection-cooled, vented top and sides Extruded aluminum, black matte powder coat finish with polycarbonate label overlay Freestanding or 2U 19-inch rack-mountable (adhesive feet and rack ears included)
Dimensions Height Width Depth	3.47 in (8.81 cm) 17.03 in (43.24 cm); 19.00 in (48.26 cm) with ears 12.54 in (31.86 cm)
Weight: MPS-200 MPS-200-70V MPS-200-100V	9.5 lbs (4.3 kg) 11.3 lbs (5.1 kg) 11.3 lbs (5.1 kg)
Available Models: MPS-200 MPS-200-70V MPS-200-100V	Multimedia Presentation System 200 w/Stereo Amplifier Multimedia Presentation System 200 with 70 Volt Amplifier Multimedia Presentation System 200 with 100 Volt Amplifier
Available Accessories: APAD C2N-DB12 C2N-FTB C2N-MNETGW CLS-C6(M) CLW-DIM1RF and CLW-SW1RF CNSP-XX CNX-B12 CNXRMIRD IRP2 QM-AMP3X80MM QM-AMP3X80SR	Wall Mount LCD Controller 12-Button Decorator Keypad FlipTop Control Center InfiNET Gateway iLux Integrated Lighting System InfiNET Dimmer and Switch Custom Serial Interface Cable 12-Button Designer Keypad IR Receiver IR Probe 3-Channel Multimedia Amplifier 3-Channel Sound Reinforcement Amplifier

Physical Description

This section provides information on the connections, controls and indicators available on your MPS-200.

MPS-200 Physical View (Front)



MPS-200 Physical View (Rear)



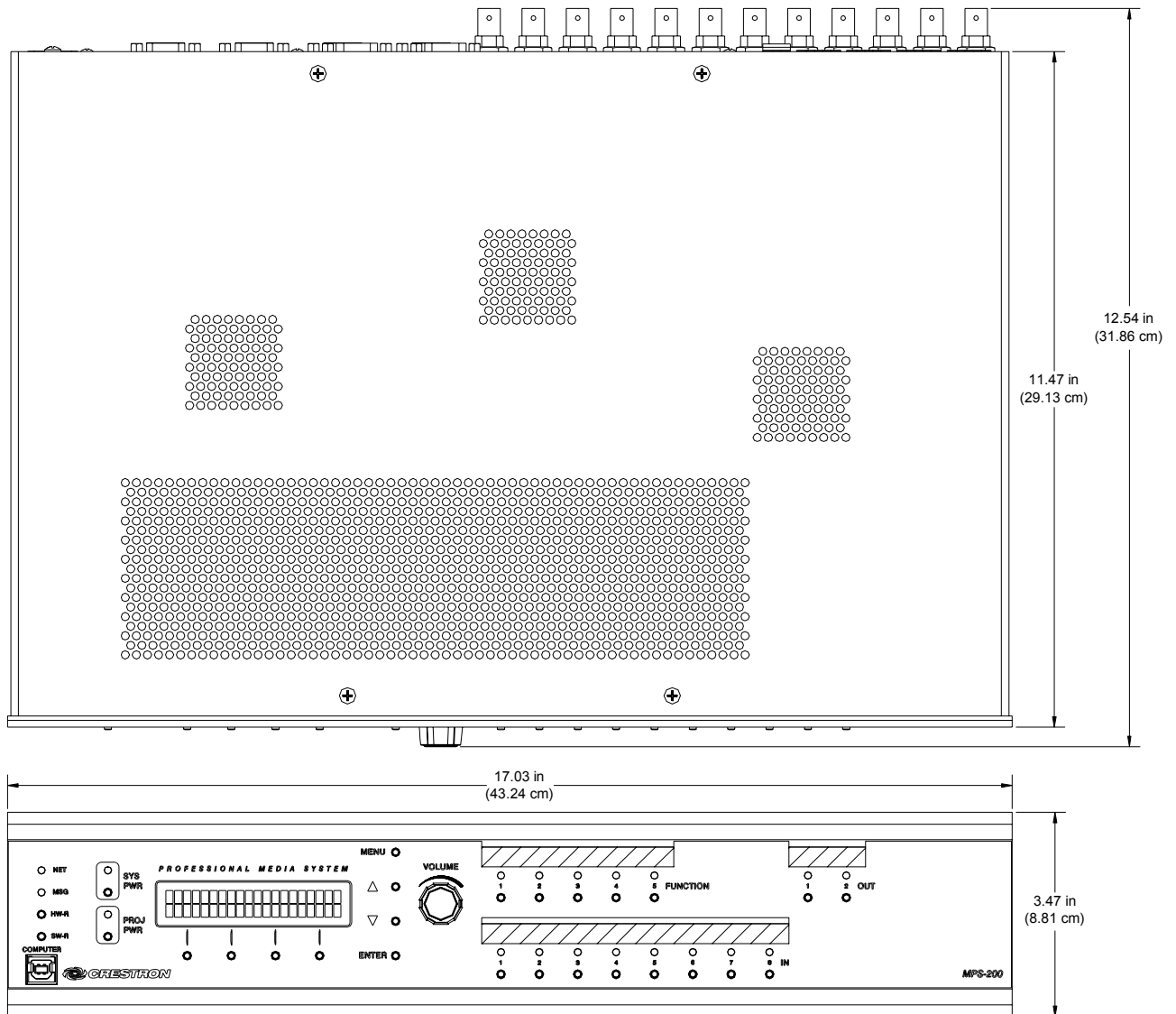

MPS-200 Overall Dimensions

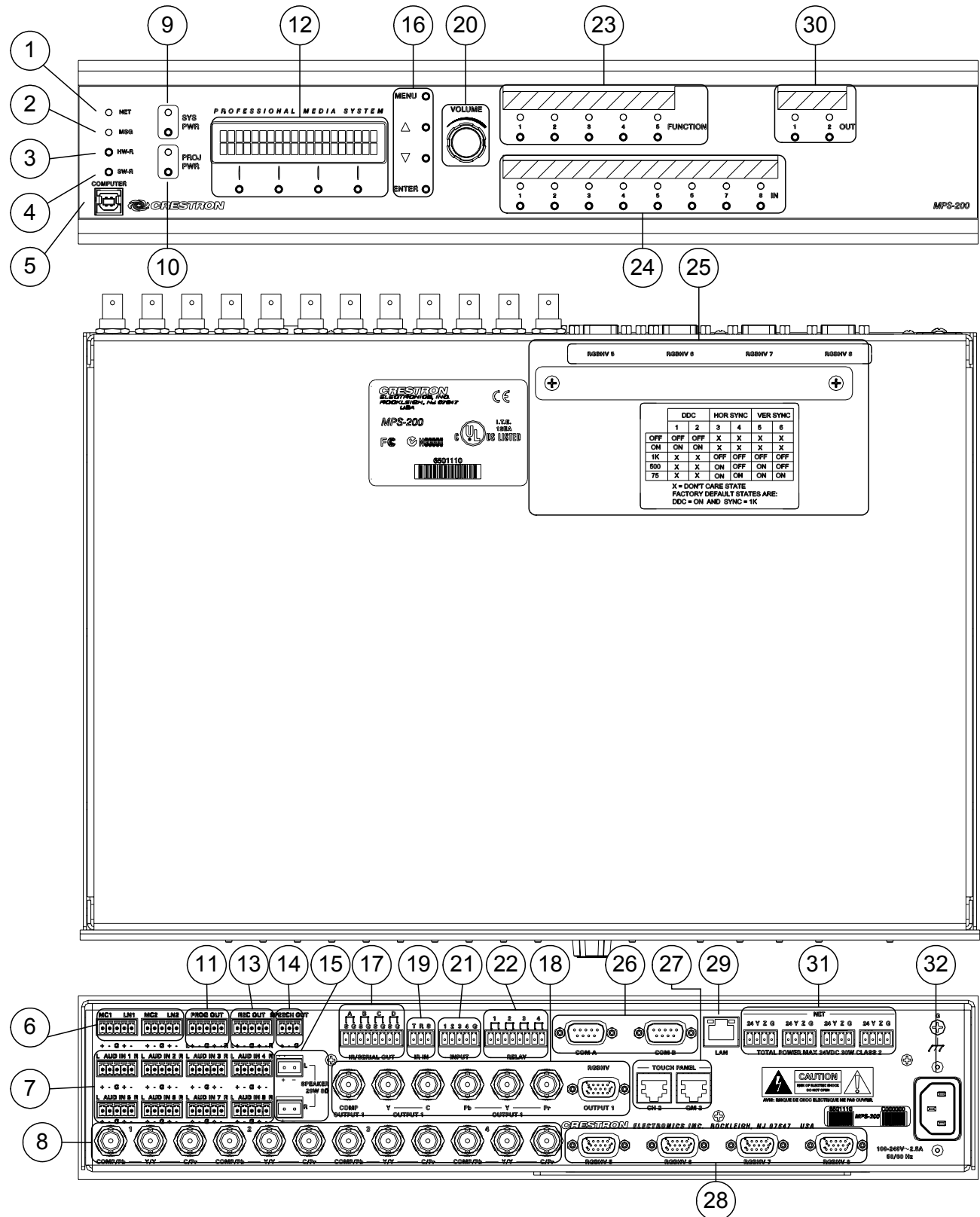

MPS-200 Buttons and Ports



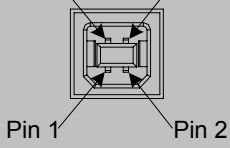



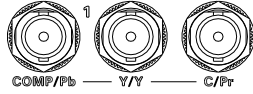

Connectors, Controls & Indicators

#	CONNECTORS ¹ , CONTROLS & INDICATORS	DESCRIPTION										
1	NET LED	Indicates communication with Cresnet devices.										
2	MSG LED	Illuminates when a message is present in the message log. To view the contents of the message log, use the front panel buttons or Crestron Toolbox.										
3 & 4	RESET BUTTONS	HW-R – Initiates system hardware reset. SW-R – Pressing this in combination with HW-R button performs a system restart without loading the program. Pressing it alone momentarily while the system is running restarts the program.										
5	<p>COMPUTER</p> 	<p>(1) USB Type B female USB 1.1 computer console port (cable included)</p> <table border="1"> <thead> <tr> <th>PIN</th> <th>DESCRIPTION</th> </tr> </thead> <tbody> <tr> <td>1</td> <td>+5 VDC</td> </tr> <tr> <td>2</td> <td>Data -</td> </tr> <tr> <td>3</td> <td>Data +</td> </tr> <tr> <td>4</td> <td>Ground</td> </tr> </tbody> </table>	PIN	DESCRIPTION	1	+5 VDC	2	Data -	3	Data +	4	Ground
PIN	DESCRIPTION											
1	+5 VDC											
2	Data -											
3	Data +											
4	Ground											
6	<p>MC/LN 1 – 2</p> 	<p>(2) 5-pin 3.5mm detachable terminal blocks; Comprises (2) Balanced microphone/line inputs;</p> <p>Balanced Mic Input Level: -52 to -12 dBV, 240 mV_{rms} maximum;</p> <p>Balanced Line Input Level: -28 to +11 dBV; 3.7 V_{rms} maximum;</p> <p>Unbalanced Line Input Level: -34 to +5 dBV; 1.85 V_{rms} maximum;</p> <p>Mic Input Impedance: 3.9k ohms, accepts 60 to 600 ohm source;</p> <p>Line Input Impedance: 19k ohms (balanced), 9.5k ohms (unbalanced);</p> <p>Phantom Power: 10 mA (total) @ 48 Volts DC, software enabled to both mic inputs</p>										
7	<p>AUDIO INPUTS 1-8</p> 	<p>(8) 5-pin 3.5mm detachable terminal blocks; Balanced/unbalanced stereo line-level inputs;</p> <p>Input Impedance: 24k ohms balanced/unbalanced;</p> <p>Balanced Input Level: -20 to +12 dBV; 4 V_{rms} maximum;</p> <p>Unbalanced Input Level: -20 to +6 dBV; 2 V_{rms} maximum</p>										

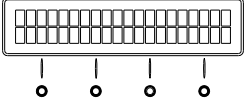
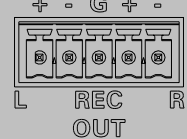

(Continued on following page)

Connectors, Controls & Indicators (Continued)

#	CONNECTORS ¹ , CONTROLS & INDICATORS	DESCRIPTION
8	VIDEO INPUTS 1 - 4 	(4) sets of (3) BNC female video inputs, each set configurable as: <ul style="list-style-type: none"> • (1) Component/HDTV (YP_bP_r) video input, or • (1) S-video (Y/C) input, or • (1) Composite input Input Level: 1 V _{p-p} nominal; Input Impedance: 75 ohms nominal; DC Offset: Insensitive to DC offset (AC coupled); Video signal sensing on COMP/P _b and Y/Y
9	SYSTEM POWER 	(1) pushbutton and green LED, controls system power
10	PROJECTOR POWER 	(1) pushbutton and green LED, controls display device power
11	PROGRAM OUT (L/R) 	(1) 5-pin 3.5 mm detachable terminal block; Balanced/unbalanced stereo line-level output; Output Impedance: 200 ohms balanced, 100 ohms unbalanced; Maximum Output Level: 4 V _{rms} balanced, 2 V _{rms} unbalanced
12	LCD DISPLAY AND SOFT BUTTONS 	Green LCD alphanumeric, adjustable backlight; 2 lines x 20 characters per line; Displays input/outputs by name, volume level bargraph, setup menus, time/date, and other system information (4) pushbuttons for activation of LCD driven functions and passcode entry
13	REC OUT 	(1) 5-pin 3.5mm detachable terminal block; Balanced/unbalanced, stereo line-level output; Output Impedance: 200 ohms balanced, 100 ohms unbalanced; Maximum Output Level: 4 V _{rms} balanced, 2 V _{rms} unbalanced Note: Does not include relay mute
14	SPEECH OUT 	(1) 3-pin 3.5mm detachable terminal block; Balanced/unbalanced mono line-level output; Output Impedance: 200 ohms balanced, 100 ohms unbalanced; Maximum Output Level: 4 V _{rms} balanced, 2 V _{rms} unbalanced



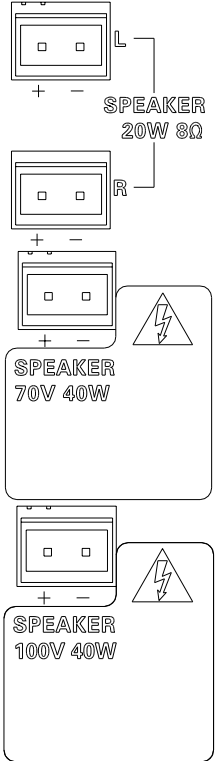

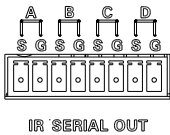
(Continued on following page)

Connectors, Controls & Indicators (Continued)

#	CONNECTORS ¹ , CONTROLS & INDICATORS	DESCRIPTION
15	<p>SPEAKER OUTPUTS</p> 	<p>(1 or 2) 2-pin 7.62mm detachable terminal blocks; Speaker-level audio outputs (MPS-200);</p> <p>(1) 2-pin 7.62mm detachable terminal blocks; Speaker-level audio outputs (MPS-200-70V and MPS-200-100V)</p> <p>Wire Size: Connector accepts 12 AWG maximum</p> <p>Output Power (MPS-200): 20W RMS per channel stereo into 8 ohms, 4 ohms tolerant;</p> <p>Output Power (MPS-200-70V): 40W RMS mono at 70 Volts;</p> <p>Output Power (MPS-200-100V): 40W RMS mono at 100 Volts</p>
16	<p>NAVIGATION BUTTONS</p> 	<p>(4) Pushbuttons for navigating the configuration menus of the MPS-200</p>
17	<p>IR/SERIAL OUT</p> 	<p>(4) 2-pin 3.5mm detachable terminal blocks, IR/Serial output ports; IR output up to 1.2 MHz; One-way serial TTL/RS-232 (0-5 Volts)² up to 9600 baud</p>

(Continued on following page)

Connectors, Controls & Indicators (Continued)

#	CONNECTORS ¹ , CONTROLS & INDICATORS	DESCRIPTION
18	<p style="text-align: center;">OUTPUT 1</p> 	<p>Contains composite, S-video (Y/C), component (Y, P_b, P_r) and RGBHV outputs on six BNC connectors and one DB15HD connector.</p> <p>Composite Output: (1) BNC female composite video output Output Level: 1.0 to 1.1 V_{p-p} (terminated, with 1 V_{p-p} input) Output Impedance: 75 ohms nominal</p> <p>Y/C (S-video): (2) BNC female; S-video (Y/C) video output Output Level: 1.0 to 1.1 V_{p-p} (terminated, with 1 V_{p-p} input); Output Impedance: 75 ohms nominal</p> <p>Y/P_b/P_r (component) Output: (3) BNC female; Component/HDTV (YP_bP_r) video output Output Level: 1.0 to 1.1 V_{p-p} (terminated, with 1 V_{p-p} input); Output Impedance: 75 ohms nominal</p> <p>RGBHV Output: (1) DB15HD female, RGBHV (VGA) output; Format: RGBHV or RGBS; RGB Output Level: 0.7 to 0.75 V_{p-p} (terminated, with 0.7 V_{p-p} input, unity gain); RGB Output Impedance: 75 ohms nominal; Sync Output Level: 4 to 5 V_{p-p}; Sync Output Impedance: 55 ohms; Sync Polarity: Follows input</p>
19	<p style="text-align: center;">IR IN</p>  <p style="text-align: center;">IR IN</p>	<p>(1) 3-pin 3.5 mm detachable terminal block; For connection of the CNXRMIIRD IR Receiver (sold separately); Allows IR wireless control from Crestron or third-party remotes using RC-5 IR commands.</p>
20	<p style="text-align: center;">VOLUME CONTROL</p> 	<p>(1) Continuous turn rotary encoder, adjusts menu parameters, defaults to program audio volume</p>
21	<p style="text-align: center;">INPUT</p>  <p style="text-align: center;">INPUT</p>	<p>(1) 5-pin 3.5mm detachable terminal block; Comprises (4) digital/contact closure inputs; Rated for 0-24 Volts DC, referenced to GND; Input Impedance: 2.2k ohms pulled up to 5 Volts DC; Logic Threshold: 2.5 Volts DC nominal with 1 Volt hysteresis band</p>

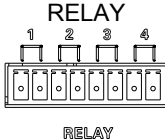
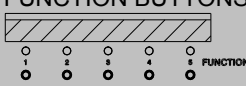
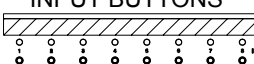
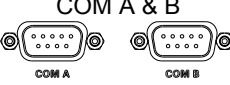

(Continued on following page)

Connectors, Controls & Indicators (Continued)

#	CONNECTORS ¹ , CONTROLS & INDICATORS	DESCRIPTION																														
22		(1) 8-pin 3.5mm detachable terminal block; Comprises (4) normally open, isolated relays; Rated 1 Amp, 30 Volts AC/DC; MOV arc suppression across contacts																														
23		(5) pushbuttons and red LEDs, programmable for any control system function. When using the out-of-the-box functionality, the buttons control the projector screen and lighting (if connected).																														
24		(8) pushbuttons and red LEDs, select input to be routed.																														
25	<p>RGB DIP SWITCHES</p>	(4) Banks of DIP switches (one per RGB output) for configuring the horizontal and vertical sync impedances of each RGB input. Each bank of DIP switches can also be configured to simulate the presence of a monitor to RGB outputs that require a monitor to be connected. For more information, refer to "Configure the RGB Input Ports" on page 27.																														
26		<p>(2) DB9 male, bidirectional RS-232 ports; Up to 115.2k baud, hardware and software handshaking support for communication with serial devices. Can also be used for modem communications. The following table lists the pin assignments of the serial ports.</p> <table border="1"> <thead> <tr> <th>PIN</th> <th>DIRECTION</th> <th>DESCRIPTION</th> </tr> </thead> <tbody> <tr> <td>1</td> <td>To MPS-200</td> <td>(DCD) Data Carrier Detect</td> </tr> <tr> <td>2</td> <td>To MPS-200</td> <td>(RXD) Receive Data</td> </tr> <tr> <td>3</td> <td>From MPS-200</td> <td>(TXD) Transmit Data</td> </tr> <tr> <td>4</td> <td>From MPS-200</td> <td>(DTR) Data Terminal Ready</td> </tr> <tr> <td>5</td> <td>Common</td> <td>(GND) Ground</td> </tr> <tr> <td>6</td> <td>To MPS-200</td> <td>(DSR) Data Set Ready</td> </tr> <tr> <td>7</td> <td>From MPS-200</td> <td>(RTS) Request To Send</td> </tr> <tr> <td>8</td> <td>To MPS-200</td> <td>(CTS) Clear To Send</td> </tr> <tr> <td>9</td> <td>To MPS-200</td> <td>(RI) Ring Indicator</td> </tr> </tbody> </table>	PIN	DIRECTION	DESCRIPTION	1	To MPS-200	(DCD) Data Carrier Detect	2	To MPS-200	(RXD) Receive Data	3	From MPS-200	(TXD) Transmit Data	4	From MPS-200	(DTR) Data Terminal Ready	5	Common	(GND) Ground	6	To MPS-200	(DSR) Data Set Ready	7	From MPS-200	(RTS) Request To Send	8	To MPS-200	(CTS) Clear To Send	9	To MPS-200	(RI) Ring Indicator
PIN	DIRECTION	DESCRIPTION																														
1	To MPS-200	(DCD) Data Carrier Detect																														
2	To MPS-200	(RXD) Receive Data																														
3	From MPS-200	(TXD) Transmit Data																														
4	From MPS-200	(DTR) Data Terminal Ready																														
5	Common	(GND) Ground																														
6	To MPS-200	(DSR) Data Set Ready																														
7	From MPS-200	(RTS) Request To Send																														
8	To MPS-200	(CTS) Clear To Send																														
9	To MPS-200	(RI) Ring Indicator																														

(Continued on following page)

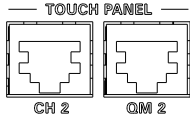
Connectors, Controls & Indicators (Continued)

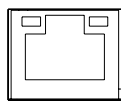
#	CONNECTORS ¹ , CONTROLS & INDICATORS	DESCRIPTION
27	TOUCH PANEL OUT  <p>The diagram shows two RJ-45 female connectors side-by-side. The left one is labeled 'CH 2' and the right one is labeled 'QM 2'. Above them is the text 'TOUCH PANEL' with a horizontal line above it.</p>	Contains one CH port and one QM port. CH Port: 8-wire RJ-45 female; CAT5 balanced video output port; Signal Types: Dynamically configurable for component (Y/P _b /P _r), S-video (Y/C), or composite video; Video/HDTV Formats: NTSC or PAL, HDTV up to 1080i; Output Impedance: 100 ohms balanced; Connects to CH CAT5 balanced video input port of a compatible touchpanel or other device via CresCAT [®] cable. ³ QM Port: 8-wire RJ-45 female; QuickMedia output port; Signal Types: Dynamically configurable for RGBHV, component (YP _b P _r), S-video (Y/C), or composite video with stereo program and 2-channels microphone audio; RGB Format: RGBHV or RGBS; RGB Output Resolution, Non-interlaced: 1920 x 1200 maximum (60 Hz limit at 1600 x 1200 or higher); Video/HDTV Formats: NTSC or PAL, HDTV up to 1080i/1080p; Connects to QM input port of a compatible touchpanel or other QuickMedia device via CresCAT-QM or CresCAT-IM cable. ⁴
28	RGBHV INPUTS 5 - 8  <p>The diagram shows a DB15HD female connector with 15 pins. The label 'RGBHV 3' is centered below the connector.</p>	(4) DB15HD female, RGBHV (VGA) inputs; Format: RGBHV or RGBS; RGB Input Level: 1 V _{p-p} nominal; RGB Input Impedance: 75 ohms nominal; Sync Input Level: 2 to 5 V _{p-p} ; Sync Input Impedance: 75, 500, or 1k ohms individually selectable for H and V via bottom panel DIP switches (#25); Video signal sensing on "H-SYNC"; Defeatable DDC pull-up resistors individually selectable via internal DIP switches (#25)
29	LAN  <p>The diagram shows an RJ-45 connector with two LEDs on top. The label 'LAN' is centered above the connector.</p>	(1) 8-wire RJ-45 with two LED indicators; 10/100BaseT Ethernet port; Green LED indicates link status; Yellow LED indicates Ethernet activity

(Continued on following page)

Connectors, Controls & Indicators (Continued)

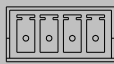
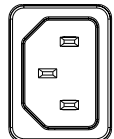
#	CONNECTORS ¹ , CONTROLS & INDICATORS	DESCRIPTION
30	OUTPUT SELECTION 	(2) pushbuttons and red LEDs, select output destination
31	NET 24 Y Z G 	(4) 4-pin 3.5mm detachable terminal blocks; Cresnet Master ports, paralleled; Available Cresnet Power: 30 Watts Pin 1 (24) Power Pin 2 (Y) Data Pin 3 (Z) Data Pin 4 (G) Ground
32	100 – 240V ~2.5A 50/60 Hz (POWER SUPPLY) 	(1) IEC Socket, mates with removable power cord (included).

- Interface connectors for NET, INFRARED-SERIAL, INPUT, RELAY OUTPUT, and AUDIO ports are provided with the unit.
- Transmission levels on the infrared – serial output connectors are in the 0 to +5 VDC range, which may not be compatible with all RS-232 devices.
- This eight-pin RJ-45 port provides connectivity to a touchpanel with a CH input port or a Crestron device with a CAT5 video input. This port provides component, composite or S-video balanced output over CAT5 wiring. Refer to the following table for connector pinouts.

RJ-45 PIN NUMBER	WIRE COLORS (568B)	COMPOSITE	S-VIDEO	COMPONENT
1	WHITE/ORANGE	+ Composite	+ Luminance	+ Y
2	ORANGE	- Composite	- Luminance	- Y
3	WHITE/GREEN	N/A	+ Chrominance	+ P _b
4	BLUE	N/A	N/A	+ P _r
5	WHITE/BLUE	N/A	N/A	- P _r
6	GREEN	N/A	- Chrominance	- P _b
7	WHITE/BROWN	N/A	N/A	N/A
8	BROWN	N/A	N/A	N/A

- The eight-pin RJ-45 QuickMedia transport port accepts CAT5E/CAT6 carrying RGB, audio, video and microphone signals. The QM port conforms to the 568B wiring standard. Refer to the following table for connector pinouts.

RJ-45 PIN NUMBER	WIRE COLORS (EIA 568B)	QM ASSIGNMENT RGB	QM ASSIGNMENT COMPOSITE, S-VIDEO, COMPONENT AND AUDIO
1	WHITE/ORANGE	- RGB Red	- CHROMINANCE (- P _r)
2	ORANGE	+ RGB Red	+ CHROMINANCE (+ P _r)
3	WHITE/GREEN	- RGB Green	- LUMINANCE (- Y)
4	BLUE	+ Digital Audio	+ AUDIO
5	WHITE/BLUE	- Digital Audio	- AUDIO
6	GREEN	+ RGB Green	+ LUMINANCE (+ Y)
7	WHITE/BROWN	- RGB Blue	- COMPOSITE (- P _b)
8	BROWN	+ RGB Blue	+ COMPOSITE (+ P _b)

Industry Compliance

This product is Listed to applicable UL Standards and requirements by Underwriters Laboratories Inc.

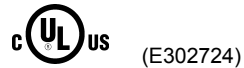

As of the date of manufacture the MPS-200 has been tested and found to comply with specifications for CE marking and standards per EMC and Radiocommunications Compliance Labelling.



NOTE: This device complies with part 15 of the FCC rules. Operation is subject to the following two conditions: (1) this device may not cause harmful interference and (2) this device must accept any interference received, including interference that may cause undesired operation.

This equipment has been tested and found to comply with the limits for a Class B digital device, pursuant to part 15 of the FCC Rules. These limits are designed to provide reasonable protection against harmful interference in a residential installation. This equipment generates, uses and can radiate radio frequency energy and if not installed and used in accordance with the instructions, may cause harmful interference to radio communications. However, there is no guarantee that interference will not occur in a particular installation. If this equipment does cause harmful interference to radio or television reception, which can be determined by turning the equipment off and on, the user is encouraged to try to correct the interference by one or more of the following measures:

- Reorient or relocate the receiving antenna.
 - Increase the separation between the equipment and receiver.
 - Connect the equipment into an outlet on a circuit different from that to which the receiver is connected.
 - Consult the dealer or an experienced radio/TV technician for help.
-

Setup

Network Wiring

When wiring the network, consider the following:

- Use Crestron Certified Wire.
- Provide sufficient power to the system.

CAUTION: Insufficient power can lead to unpredictable results or damage to the equipment. Please use the Crestron Power Calculator to help calculate how much power is needed for the system (<http://www.crestron.com/calculators>).

- For larger networks, use a Cresnet Hub/Repeater (CNXHUB) to maintain signal quality.

For more details, refer to “Check Network Wiring” on page 84.

Ethernet

The MPS-200 also uses high-speed Ethernet for communications between the control system and a device, computer, digital media server and other IP-based devices.

For information on connecting Ethernet devices in a Crestron system, refer to the latest version of the Crestron e-Control® Reference Guide (Doc. 6052).

CAT5 Wiring

Category 5 (CAT5) wiring is a twisted pair cable designed for Ethernet networks. These networks operate at speeds of up to 100 Megabits per second (Mbps) using the 100BaseT standard. Crestron takes advantage of this specification for a variety of video applications.

Crestron recommends using CresCAT, CresCAT-D or CresCAT-Q wiring solutions.

The following chart shows the maximum recommended cable lengths for various signal formats.

Recommended Maximum Cable Lengths for Video via Crestron Certified Wire

FORMAT	MAXIMUM DISTANCE
Composite	500 feet
S-Video	500 feet
Component	500 feet

For more information, refer to the latest version of the Crestron CAT5 Wiring Reference Guide (Doc. 6137).

QuickMedia Wiring

The Crestron QuickMedia cable (sold under the name “CresCAT-QM”) contains one CAT5E cable and one Cresnet cable in Siamese jackets. Installation of any QM device is as simple as installing CresCAT-QM wires from the output of one device to the input of another. Installations are flexible, affordable and fast. For more information, refer to the latest revision of the Crestron MediaManager Applications Guide (Doc. 6244).

CresCAT-QM Cable

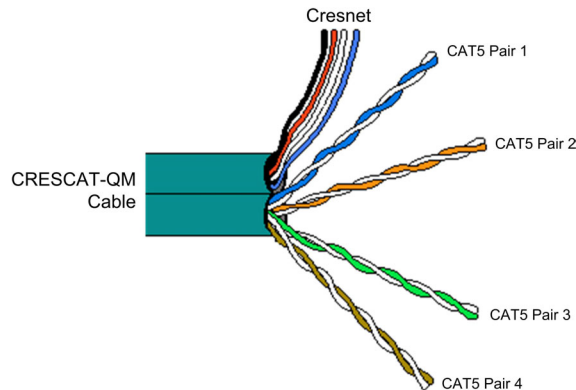

NOTE: Do not untwist the two wires in a single pair for more than 1/3-1/2” (0.84-1.27 cm) when making a connection. The twists are critical to canceling out interference between the wires.

The aggregate cable length of a signal path originating at the MPS-200 and terminating at a QM receiver must not exceed 450 feet (137 meters). Video signals may experience a loss of quality over very long lengths of cable. This phenomenon is due to the added resistance and capacitance of longer cable lengths and is not peculiar to either Crestron and/or QuickMedia systems. To ensure sufficient bandwidth, the maximum aggregate cable length should not exceed 450 feet. The use of lower-resolution signals may allow increased cable length but must be tested by the installer with the sources to be used. The QM pin assignment is based on the EIA/TIA 568B RJ-45 Jack standard.

NOTE: When transmitting S-video, luminance uses the green video pathway and chrominance uses the red video pathway. When transmitting composite video, the signal is carried on the blue video pathway.

NOTE: When using CresCAT-QM wiring, four additional wires are included for making Cresnet connections.

When connecting multiple QM devices, the route between a QM origination point (transmitter) and a QM endpoint (receiver) cannot have more than two midpoints (e.g. QM-MD7x2 or other QM switchers). Refer to the following diagram when configuring a QM network.

NOTE: Use CresCAT-QM to make QM connections. The cumulative skew over the entire length must be less than 22 ns.

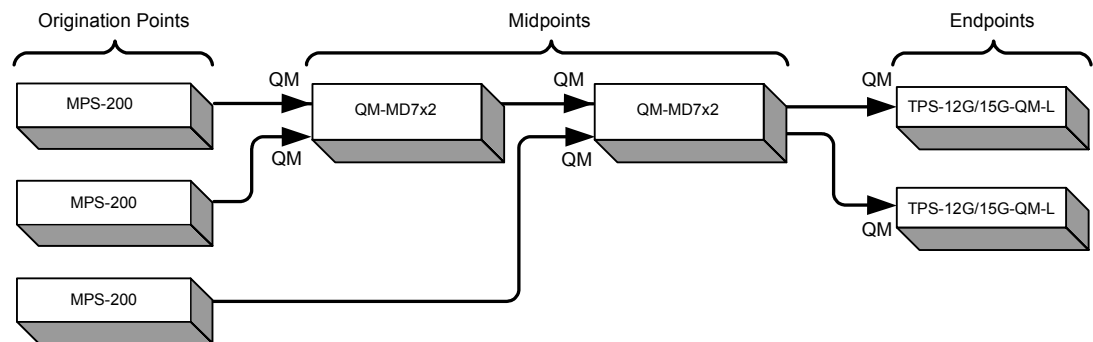
QM Network Topology**Installation****Ventilation**

The MPS-200 should be used in a well-ventilated area. The venting holes should not be obstructed under any circumstances. If the MPS-200 is hot to the touch, consider using forced air ventilation and/or incrementing the spacing between units.

To prevent overheating, do not operate this product in an area that exceeds the environmental temperature range listed in the table of specifications. Consideration must be given if installed in a closed or multi-unit rack assembly since the operating ambient temperature of the rack environment may be greater than the room ambient temperature. Contact with thermal insulating materials should be avoided on all sides of the unit.

Rack Mounting

The MPS-200 can be mounted in a rack or stacked with other equipment. Two “ears” are provided with the MPS-200 so that the unit can be rack mounted. These ears must be installed prior to mounting. Complete the following procedure to attach the ears to the unit. The only tool required is a #2 Phillips screwdriver.

WARNING: To prevent bodily injury when mounting or servicing this unit in a rack, take special precautions to ensure that the system remains stable. The following guidelines are provided to ensure your safety:

- When mounting this unit in a partially filled rack, load the rack from the bottom to the top with the heaviest component at the bottom of the rack.
- If the rack is provided with stabilizing devices, install the stabilizers before mounting or servicing the unit in the rack.

NOTE: Reliable earthing of rack-mounted equipment should be maintained. Particular attention should be given to supply connections other than direct connections to the branch circuit (e.g. use of power strips).

To install the ears:

1. There are screws that secure each side of the MPS-200 top cover. Using a #2 Phillips screwdriver, remove the three screws closest to the front panel from one side of the unit. Refer to the diagram following step 3 for a detailed view.
2. Position a rack ear so that its mounting holes align with the holes vacated by the screws in step 1.
3. Secure the ear to the unit with three screws from step 1, as shown in the following diagram.

Ear Attachment for Rack Mounting

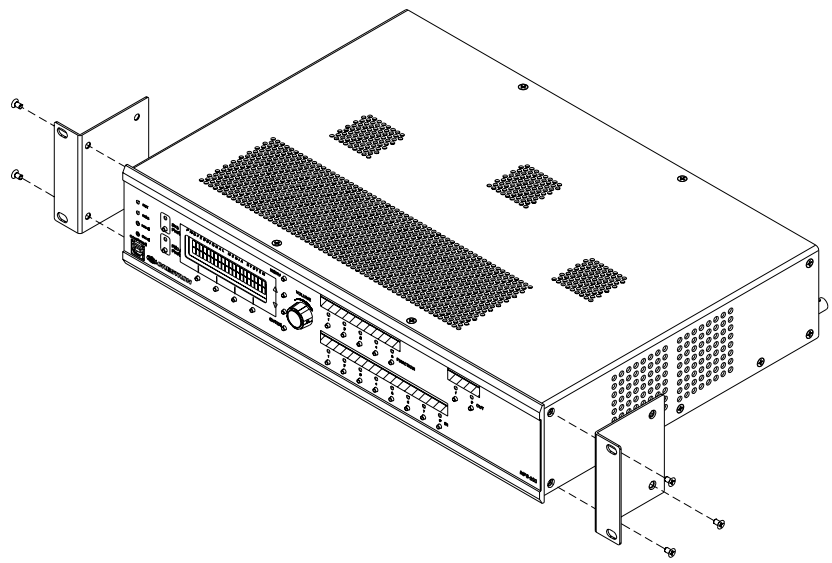

- Repeat procedure (steps 1 through 3) to attach the remaining ear to the opposite side.

NOTE: The sync input impedance and DDC feature should be set prior to placing the MPS-200 in an equipment rack. For more information, refer to “Configure the RGB Input Ports” on page 27.

Stacking

Four “feet” are located on the bottom of the MPS-200 so that if the unit is not rack mounted, the rubber feet can provide stability when the unit is placed on a flat surface or stacked.

Hardware Hookup

Make the necessary connections as called out in the illustrations that follows this paragraph. Refer to “Network Wiring” on page 21 before applying power. Apply power after all connections have been made.

Hardware Connections for the MPS-200, Front

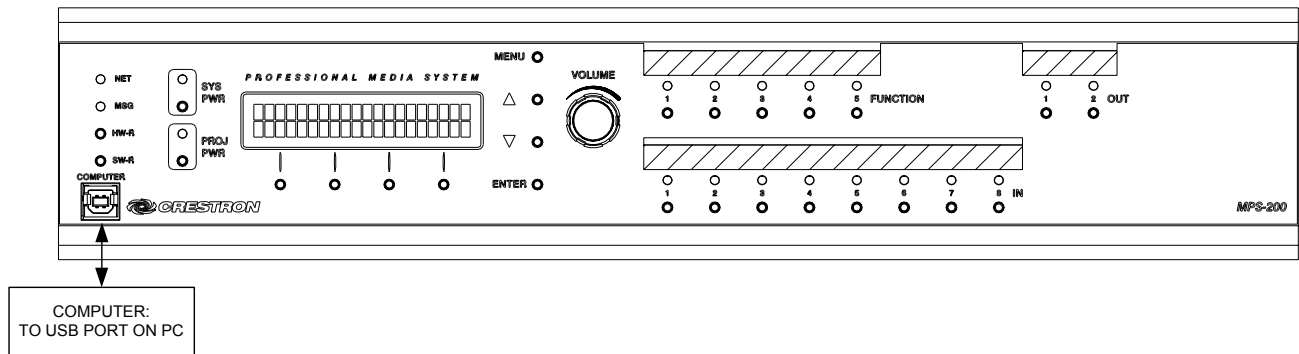

Hardware Connections for the MPS-200, Rear

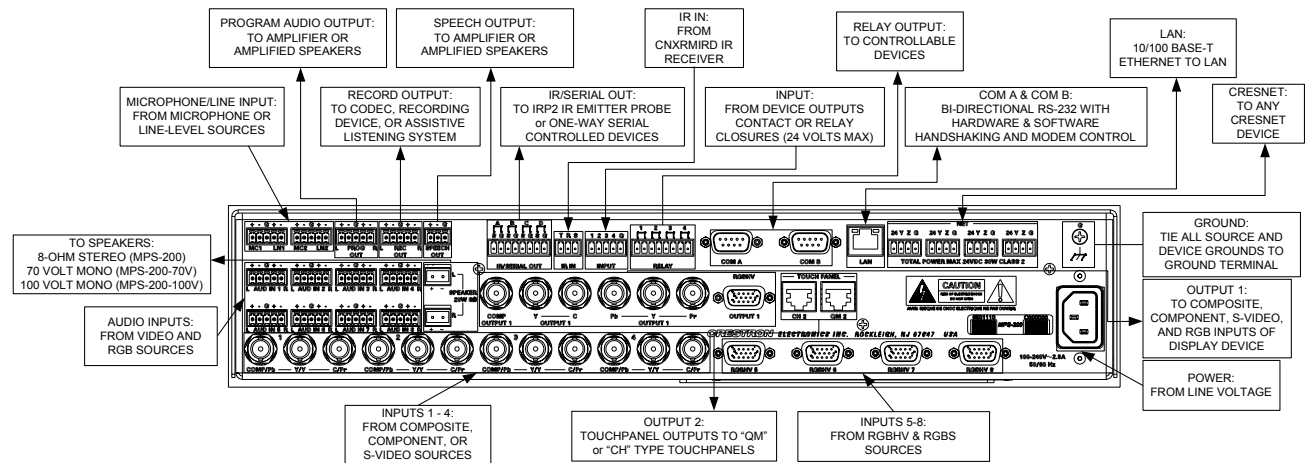

When running the out-of-the-box program, the MPS-200 can support the following Crestron devices:

- (2) APAD
- (2) C2N-FTB
- (2) CNX-B12
- (2) C2N-DB12
- (2) CLW-DIM1RF / CLW-DIMS1RF (requires Crestron Toolbox for implementation)
- (2) CLW-SW1RF / CLW-SWS1RF (requires Crestron Toolbox for implementation)
- (1) QM-AMP3x80MM/SR
- (1) C2N-MNETGW
- (1) CLS-C6
- (1) RoomView Express or RoomView Server Edition connection

CAUTION: Speakers must be rated to full available output.

CAUTION: Do not bridge speaker outputs

CAUTION: All source devices should be grounded to the MPS-200.

NOTE: The MPS-200 can only be powered by the included power cord. Power cannot be supplied from network devices that are connected to the mini-terminal block connectors.

NOTE: For Cresnet, CAT5, and QuickMedia connections, use Crestron Certified Wire.

NOTE: When running the out-of-the-box program, relays 1 and 2 are momentary.

NOTE: When running the out-of-the-box program and connecting a projector screen, the “up” control lines should be connected to relay 1 and the “down” control lines should be connected to relay 2.

NOTE: To analyze Cresnet lines, the C2N-ANLZ is required. For instructions, refer to the latest version of the C2N-ANLZ Operations Guide (Doc. 6473).

Balanced and unbalanced audio inputs/outputs are provided, utilizing five-pin terminal block connectors. For connection details, refer to the following table and diagrams.

Audio Connections

SIGNAL NAME	BALANCED AUDIO INPUT	BALANCED AUDIO OUTPUT	UNBALANCED AUDIO INPUT	UNBALANCED AUDIO OUTPUT
+	1 +	1 +	1 + In	1 + Out
-	1 -	1 -	1 – signal return, jumper to GND	Open
G	Shield/ground	Shield/ground	Ground	Common ground
+	2 +	2 +	2 + In	2 + Out
-	2 -	2 -	2 – signal return jumper to GND	Open

Typical Balanced/Unbalanced Inputs

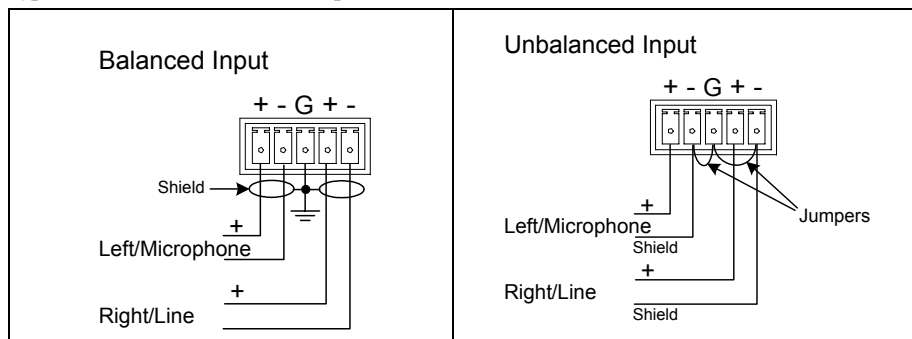

Typical Balanced/Unbalanced Outputs

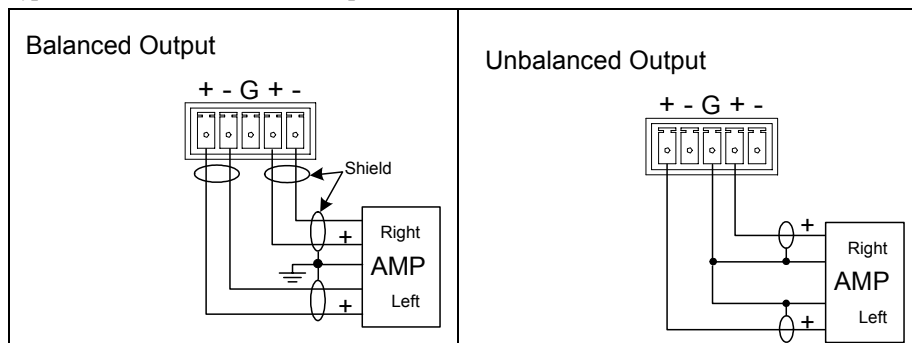

Configure the RGB Input Ports

Each of the RGB input ports feature a set of six DIP switches located inside the MPS-200. These switches are used to set the sync input impedance of each port and simulate the presence of a monitor (DDC) for each RGB input.

The sync input impedance can be set to either 1k, 500, or 75 ohms. The setting from the factory is 1k ohms and should work with most RGB sources. If the signal quality is poor, lowering the input impedance to match the impedance of coax cable may alleviate sync signal problems that are associated with RGB cables greater than the typical VESA standard (typically six feet).

For laptops that require the presence of a monitor to enable its video output, the MPS-200 has a selectable feature (DDC) that simulates the presence of a monitor so RGB sources (such as a laptop computer) will transmit a signal even when an RGB device is not connected to the MPS-200 output. Changing the DIP switch setting can enable or disable this feature. The MPS-200 is shipped from the factory with the DDC feature disabled.

NOTE: The sync input impedance and DDC feature should be set prior to placing the MPS-200 in an equipment rack.

Find the DIP Switches

The DIP switches that configure the RGB input ports are located on the bottom of the MPS-200. The only tools required are a #2 Phillips screwdriver and a grounding strap (or grounded workstation).

CAUTION: The MPS-200 contains ESD-sensitive devices. Perform the following procedure while wearing a grounding strap that is properly grounded or on a grounded workstation to avoid damaging the MPS-200.

1. Connect RGB sources and a monitor to the MPS-200 as described in “Hardware Hookup” on page 24.
2. Remove the DIP switch access panel by removing the two screws located on the bottom of the MPS-200. Use a #2 Phillips screwdriver to remove the screws.
3. Lift the access panel shown in the following diagram to expose the DIP switches. Each RGB input port has a corresponding bank of DIP switches.

DIP Switch Location

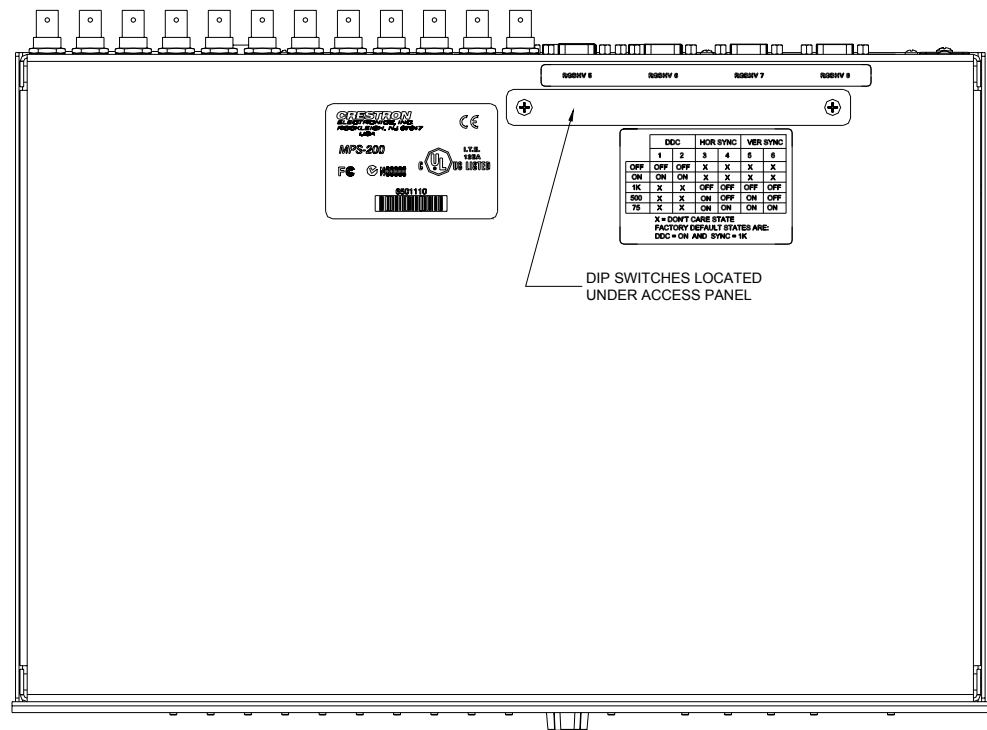

Set the DIP Switches

1. Referring to the following table, set the DIP switches of each RGB input port to the required sync input impedance and DDC functionality.

DIP Switch Function Chart

		DDC		HORIZONTAL SYNC		VERTICAL SYNC	
		1	2	3	4	5	6
FUNCTION	SETTING	SWITCH 1	SWITCH 2	SWITCH 3	SWITCH 4	SWITCH 5	SWITCH 6
DDC	OFF	OFF	OFF	X	X	X	X
	ON	ON	ON	X	X	X	X
SYNC INPUT IMPEDANCE	1K	X	X	OFF	OFF	OFF	OFF
	500	X	X	ON	OFF	ON	OFF
	75	X	X	ON	ON	ON	ON

NOTE: The function table is also located on the bottom of the MPS-200.

NOTE: The factory setting for the DIP switches are DDC disabled (switches 1 & 2 in the OFF position) and 1k ohm impedance (switches 3 through 6 in the OFF position).

2. Replace the access panel and secure the screws using the #2 Phillips screwdriver.

Further Configuration

If using the out-of-the-box functionality, the MPS-200 can be configured with the front panel. For information, refer to “Configuration” on page 35.

Label the Buttons

Use Crestron Engraver software to print custom labels for the MPS-200's front panel buttons and LEDs. Crestron recommends printing on 100-pound paper. Paper weighing less than 100 pounds will tend to crumple while sliding in, while paper weighing more than 100 pounds may not fit.

Programming Software

Have a question or comment about Crestron software?

Answers to frequently asked questions (FAQs) can be viewed in the Online Help section of the Crestron website. To post a question or view questions you have submitted to Crestron's True Blue Support, log in at <http://support.crestron.com>. First-time users will need to establish a user account.

Earliest Version Software Requirements for the PC

NOTE: Crestron recommends that you use the latest software to take advantage of the most recently released features. The latest software is available from the Crestron website.

NOTE: Crestron software and any files on the website are for authorized Crestron dealers and Crestron Authorized Independent Programmers (CAIP) only. New users may be required to register to obtain access to certain areas of the site (including the FTP site).

Crestron has developed an assortment of Windows®-based software tools to develop an MPS-200 system. The following are the minimum recommended software versions for the PC:

Software

TASK	REQUIRED SOFTWARE VERSION
Program control system to operate MPS-200.	SIMPL Windows version 2.08.34 or later with SIMPL+ Cross Compiler version 1.1 or later; Also requires Crestron Database version 18.7.4 or later.
Upload program and firmware.	Crestron Toolbox version 1.04.21 or later.
Program with simple wizards for systems using an MPS-200 (optional but recommended).	Crestron SystemBuilder™ version 3.2 or later (requires SIMPL Windows, VT Pro-e, Crestron Database and Crestron Engraver) with SystemBuilder Templates version 3.2 or later. Refer to software release notes or Crestron website for other required Crestron software packages.
Configure audio parameters	Crestron Toolbox with QM Tools version 1.04.21 or later
Create labels for front panel buttons.	Crestron Engraver version 3.4 or later.
Manage MPS-200 systems within a facility (optional).	RoomView® Express or RoomView Server Edition.

Programming with Crestron SystemBuilder

Crestron SystemBuilder is the easiest method of programming but does not offer as much flexibility as SIMPL Windows. For additional details, download SystemBuilder from the Crestron website and examine the extensive help file.

Any program created for the MPS-200 with SystemBuilder will include the out-of-the-box functionality in addition to any additional programming created with SystemBuilder.

Programming with SIMPL Windows

NOTE: While SIMPL Windows can be used to program the MPS-200, it is recommended to use SystemBuilder for configuring an MPS-200 system.

SIMPL Windows is Crestron's premier software for programming Crestron control systems. It is organized into two separate but equally important "Managers".

Any SIMPL Windows program written for an MPS-200 will contain all of the MPS-200's out-of-the-box functions in a protected area of the program. The parts of the program that contain the out-of-the-box functions are locked and cannot be changed or deleted. When a program is compiled, the custom program plus the out-of-the-box front panel functionality, including setup menus, are loaded.

NOTE: When programming an MPS-200 in SIMPL Windows, always begin with the example program and modify as required. To find example programs, refer to "Example Program" on page 32. Also visit Crestron's True Blue Support on the web for more programming tips.

Configuration Manager

Configuration Manager is the view where programmers "build" a Crestron control system by selecting hardware from the *Device Library*.

- To incorporate the MPS-200 into the system, drag the MPS-200 from the Control Systems folder of the *Device Library* and drop it in the *System Views*.

Locating the MPS-200 in the Device Library

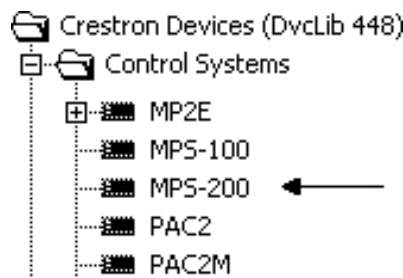

Program Manager

Program Manager is the view where programmers "program" a Crestron control system by assigning signals to symbols.

Signals that are part of the MPS-200's out-of-the-box functionality are locked and cannot be modified or deleted. Locked signals are grayed out in the MPS-200's SIMPL Windows symbols. To prevent corruption of the out-of-the-box functionality, locked signal names should not be copied or driven to other destinations in the SIMPL Windows program.

NOTE: If using SIMPL Windows version 2.08.19 or later, signals that are part of the out-of-the-box functionality may be hidden from view. To view hidden signals in a program containing out-of-the-box functionality, select *Display Out Of The Box Functionality (OOTBF) Programming* in the "SIMPL Windows Preferences" window (**Options | Preferences...**).

The symbol can be viewed by double clicking on the icon or dragging it into *Detail View*. A description for each signal in the symbol is described in the SIMPL Windows help file (**F1**).

Switching Programs

If a custom program is loaded into the MPS-200, the MPS-200 will run the custom program when it boots up. To switch to the out-of-the-box program:

1. Press and release **HW-R**.
2. Press and hold **SW-R** until "Bypassing Custom Program, Running OOTBF" is displayed on the LCD.
3. To return to the custom program simply press **HW-R** or cycle power.

Saving Settings

Settings such as tone/volume levels (out-of-the-box and custom programs) and input/output names (out-of-the-box programs) are stored in an xml and text file that can be recalled should an MPS-200 program need to be updated.

To save settings for later use, use Crestron Toolbox' File Manager utility to retrieve the *.xml (where * can be "ootbf" for settings made when running the out-of-the-box functionality program or "custom" for settings made when running a custom program) and *System Configuration.txt* files from the NVRAM Disk directory. After the new out-of-the-box functionality program or custom program has been loaded, use Windows Explorer and Crestron Toolbox' File Manager utility to place the appropriate *.xml and *System Configuration.txt* files in the NVRAM Disk directory and reboot the processor. For instructions on using Crestron Toolbox' File Manager utility, refer to the Crestron Toolbox help file.

NOTE: If switching to a different type of program (i.e. from out-of-the-box functionality to custom or vice-versa), the retrieved xml file can be renamed (*ootbf.xml* becomes *custom.xml* and *custom.xml* becomes *ootbf.xml*). The running program will import any relevant settings. Verify that all of the required settings are correct.

Example Program

An example program for the MPS-200 is available from the Crestron website (<http://www.crestron.com/exampleprograms>).

Uploading and Upgrading

Crestron recommends using the latest programming software and that each device contains the latest firmware to take advantage of the most recently released features. However, before attempting to upload or upgrade it is necessary to establish communication. Once communication has been established, files (for example, programs or firmware) can be transferred to the control system. Finally, program checks can be performed (such as changing a device ID or creating an IP table) to ensure proper functioning.

While the next section provides an overview for communication, refer to “Establishing Communications with the Control System” in the Crestron 2-Series Control Systems Reference Guide (Doc. 6256) for connection details. If communications cannot be established, refer to “Troubleshooting Communications” in the same guide.

Establishing Communication

Use Crestron Toolbox for communicating with the MPS-200; refer to the Crestron Toolbox help file for details. There are two methods of communication.

USB Communication

NOTE: Required for initial setup of Ethernet parameters.

USB Communication



- The **COMPUTER** port on the MPS-200 connects to the USB port on the PC via the included Type-A to Type B USB cable.
- Use the Address Book in Crestron Toolbox to create an entry using the expected communication protocol (USB). When multiple USB devices are connected, identify the MPS-200 by entering “MPS-200” in the *Model* textbox, the unit’s serial number in the *Serial* textbox or the unit’s hostname in the *Hostname* textbox. The hostname can be found in the “System Info” window in the section marked *Ethernet* however, communications must be established in order to see this information in the “System Info” window.

NOTE: The hostname can also be viewed using the front panel. Refer to page 61 for more information.

- Display the MPS-200’s “System Info” window (click the  icon); communications are confirmed when the device information is displayed.

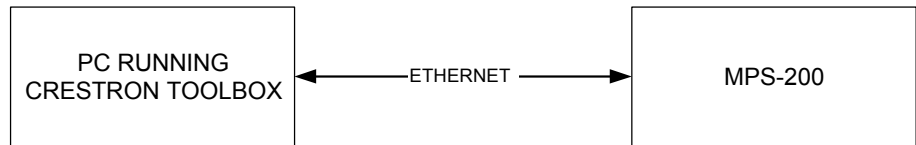
TCP/IP Communication**Ethernet Communication**

- Establish USB communications between the MPS-200 and a PC.
- Enter the IP address, IP mask and default router of the MPS-200 via the Crestron Toolbox (**Functions | Ethernet Addressing**); otherwise enable DHCP.
- Confirm Ethernet connections between MPS-200 and PC. If connecting through a hub or router, use CAT5 straight through cables with 8-pin RJ-45 connectors. Alternatively, use a CAT5 crossover cable to connect the two LAN ports directly without using a hub or router.
- Use the Address Book in the Crestron Toolbox to create an entry for the MPS-200 with the MPS-200's TCP/IP communication parameters.
- Display the "System Info" window (click the  icon) and select the MPS-200 entry.

Programs and Firmware

Program and firmware files may be distributed from programmers to installers or from Crestron to dealers. Firmware upgrades are available from the Crestron website as new features are developed after product releases. One has the option to upload programs via the programming software or to upload and upgrade via the Crestron Toolbox. For details on uploading and upgrading, refer to the SIMPL Windows help file or the Crestron Toolbox help file.

Program

If a SIMPL Windows program is provided, it can be uploaded to the control system using SIMPL Windows or Crestron Toolbox. If an updated out-of-the-box-functionality program is provided, it can be uploaded to the control system using Crestron Toolbox.

Firmware

Check the Crestron website to find the latest firmware. (New users may be required to register to obtain access to certain areas of the site, including the FTP site.)

- Upgrade MPS-200 firmware via Crestron Toolbox.
- Establish USB or TCP/IP communications with the MPS-200 and display the "System Info" window.
- Select **Functions | Firmware...** to upgrade the MPS-200 firmware.

Configuration & Operation

The MPS-200 can be used for audio and video switching without any programming required. This is ideal for those that need a basic audio-video switching system. Prior to operation, the MPS-200 must be configured for use.

Configuration

The MPS-200 is configured using the built-in menu.

Access the Menu

To access the menu:

- Press the **MENU** button. Instructions for entering the password will be displayed followed by a blinking cursor that prompts you to enter the password.

Enter Password

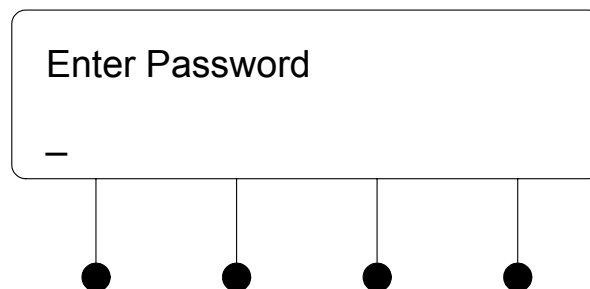

- Enter the password with the volume control and the ▼ and ▲ buttons.

NOTE: Administrator and user passwords can be created in SystemBuilder when creating a custom program. Refer to the SystemBuilder help file for more information. Users who enter an administrator password can change any of the MPS-200 settings. Users who enter a user password can only view the MPS-200 settings. The MPS-200 can determine when an administrator or user password is entered.

NOTE: If running the out-of-the-box program, the default password (which has the same rights as an administrator password) is **12345**. It can be changed within the Control Setup menu. Refer to page 66 for more information.

- ⇒ Turn the volume control until the correct digit is displayed.
- ⇒ Press the ▲ button to move the cursor to the next digit and select the next digit in the password with the volume control. Press the ▼ button to move to the previous digit.
- ⇒ Press **ENTER** once the password is displayed. If an incorrect password is entered, the display will show “Invalid Password” and return to the Enter Password screen.

Exit the Menu

To exit the menu:

- While in the main menu, press the **MENU** button to exit the menu.

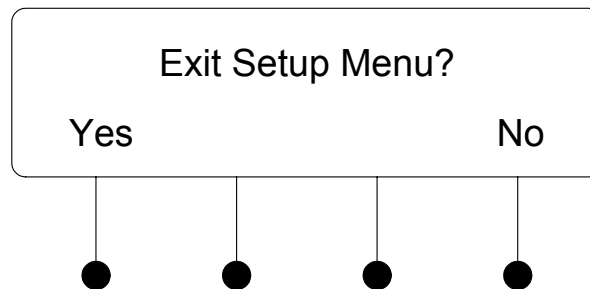
Exit Menu Prompt

⇒ Press the soft button labeled **Yes** to exit the menu or press the soft button labeled **No** to return to the menu.

NOTE: The following sections describe configuration instructions when the MPS-200 is running the out-of-the-box program or if an administrator password was entered (while a custom program is running). If a user password was entered while a custom program is running, the user can view the settings but cannot make changes. For information on administrator and user passwords, refer to the SystemBuilder help file.

NOTE: When the system is being configured, system operation is suspended.

Menu Structure

The following diagram displays the menu structure of the MPS-200.

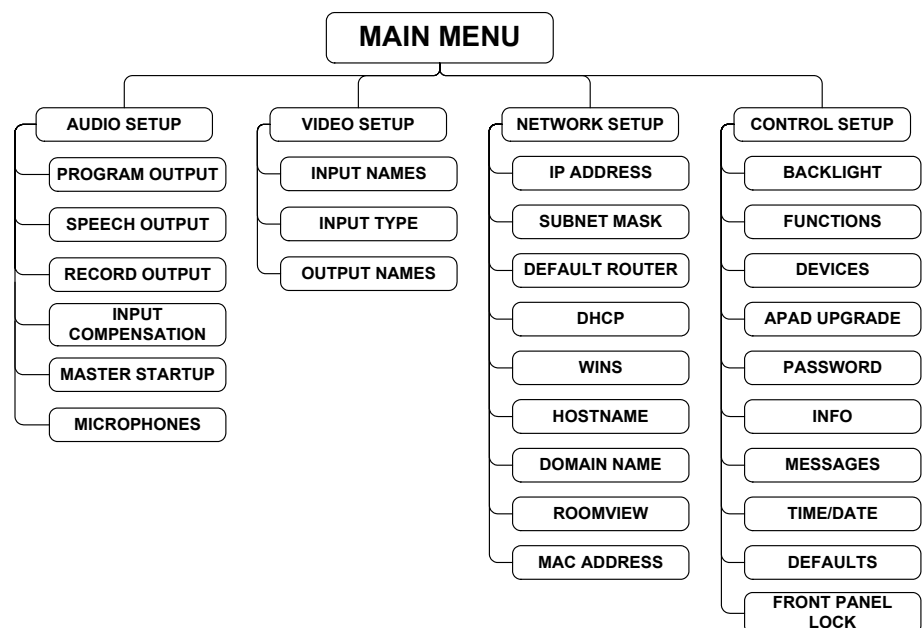
MPS-200 Menu Structure

The menu is separated into four sections.

- **Audio Setup:** Contains controls for **PROGRAM**, **SPEECH**, and

RECORD output settings, source input compensation, master startup volume, and microphones.

- **Video Setup:** Contains controls for naming input sources, selecting input signal types (video inputs only), and naming output destinations.
- **Network Setup:** Contains controls for setting the IP address of the MPS-200, the IP address of the subnet mask used by the MPS-200, the IP address of the default router used by the MPS-200, the DHCP mode of the MPS-200, and the WINS mode of the MPS-200. The Network Setup section can also display the hostname and MAC address of the MPS-200 as well as the domain name used by the MPS-200. The MPS-200's RoomView settings can also be adjusted.
- **Control Setup:** Contains controls for adjusting the LCD backlight, naming the function buttons, identifying network devices, updating connected APAD devices, setting the front panel password, displaying system information, displaying system messages, setting the time and date, and restoring default settings.

Audio Setup

The audio characteristics of the MPS-200 can be configured from the front panel using the Audio Setup menu.

Access the Audio Setup Menu

To access the Audio Setup menu:

- Access the menu as described on page 35. The words "Audio Setup" will be displayed.
- Press **ENTER** to open the Audio Setup menu.
- To exit the Audio Setup menu, press **MENU**.

Program Output

The *Program Output* section of the Audio Setup menu is used to set the **PROGRAM** output's volume level, source mix, bass, treble, minimum volume, maximum volume, stereo/mono mode, and startup volume. The **RECORD** and **SPEECH** outputs are not affected by changes made from the program output menu.

Access the Program Output Menu

To access the Program Output menu:

- Access the Audio Setup menu as described above.
- Press **ENTER** to open the Program Output menu.
- To return to the Audio Setup menu, press **MENU**.

Set the Program Volume Level

To set the Program Volume level:

- Access the Program Output menu as described above.
- Adjust the Program Volume level by turning the volume control clockwise to raise the volume, or counterclockwise to lower the volume. When adjusting the volume, the display will change to indicate the volume level.

Set the Program Source Mix

To set the **PROGRAM** output's source mix:

- Access the Program Output menu as described above.

- Press the ▲ or ▼ buttons until “Source Mix” is displayed on the LCD and press **ENTER** to open the Program Source Mix controls.

Program Source Mix Controls

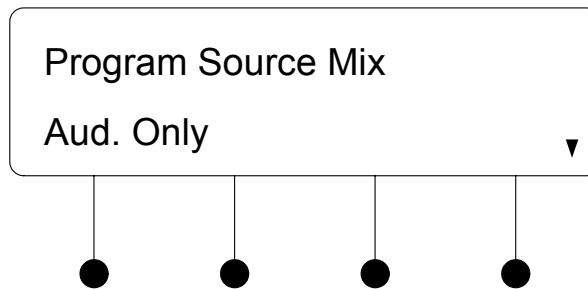

- Press the ▲ or ▼ buttons until the desired setting is displayed on the LCD. The current setting is indicated with an asterisk (*). The following settings are available:
 - ⇒ **Aud. Only**: Sends the audio signal from the selected source to the **PROGRAM** output.
 - ⇒ **Mic. Only**: Sends the microphone input signals to the **PROGRAM** output.
 - ⇒ **Mic + Aud**: Sends a mix of the audio signal from the selected source and the microphone input signals to the **PROGRAM** output.

NOTE: While setting the program source mix, the Program Volume level can be adjusted by turning the volume control clockwise to raise the volume, or counterclockwise to lower the volume. When adjusting the volume, the display will change to indicate the volume level.

- Press **ENTER** to save changes and return to the previous screen. To cancel without saving changes, press **MENU**.

Set the Program Bass Level

To set the Program Bass level:

- Access the Program Output menu as described on page 37.
- Press the ▲ or ▼ buttons until “Bass” is displayed on the LCD and press **ENTER** to open the Program Bass controls. The current bass level will be displayed.

Program Bass Controls

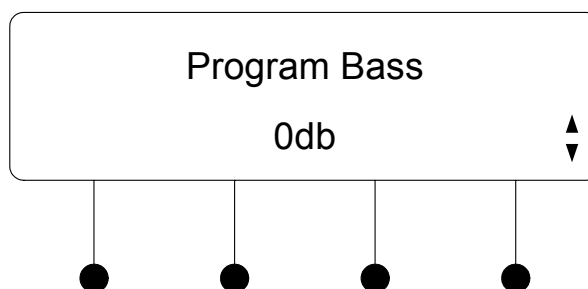

- Adjust the Program Bass level with the ▼ and ▲ buttons. Press the ▲ button to increase the bass level. Press the ▼ button to lower the bass level.

NOTE: While adjusting the Program Bass level, the Program Volume level can be adjusted by turning the volume control clockwise to raise the volume, or counterclockwise to lower the volume. When adjusting the volume, the display will change to indicate the volume level.

- Press **MENU** or **ENTER** to save changes and return to the previous screen.

Set the Program Treble Level

To set the Program Treble level:

- Access the Program Output menu as described on page 37.
- Press the ▲ or ▼ buttons until “Treble” is displayed on the LCD and press **ENTER** to open the Program Treble controls. The current treble level will be displayed.

Program Treble Control

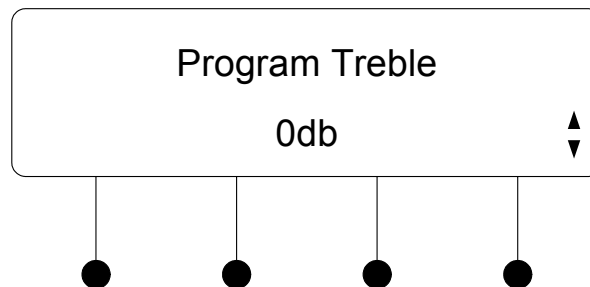

- Adjust the Program Treble level with the ▼ and ▲ buttons. Press the ▲ button to increase the treble level. Press the ▼ button to lower the treble level.

NOTE: While adjusting the Program Treble level, the Program Volume level can be adjusted by turning the volume control clockwise to raise the volume, or counterclockwise to lower the volume. When adjusting the volume, the display will change to indicate the volume level.

- Press **MENU** or **ENTER** to save changes and return to the previous screen.

Set the Program Minimum Volume

The Program Minimum Volume control is used to set the lowest volume setting of the **PROGRAM** output. The **RECORD** and **SPEECH** outputs are not affected by changes made to the Program Minimum Volume level.

To set the Program Minimum Volume level:

- Access the Program Output menu as described on page 37.
- Press the ▲ or ▼ buttons until “Min Volume” is displayed on the LCD and press **ENTER** to open the Program Minimum Volume controls.

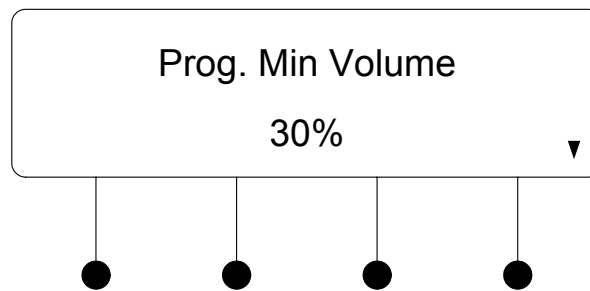
Program Minimum Volume Control

- Adjust the Program Minimum Volume level with the ▼ and ▲ buttons. Press the ▲ button to increase the Program Minimum Volume level. Press the ▼ button to lower the Program Minimum Volume level. The highest Program Minimum Volume setting is 30%.

NOTE: While adjusting the Program Minimum Volume level, the Program Volume level can be adjusted by turning the volume control clockwise to raise the volume, or counterclockwise to lower the volume. When adjusting the volume, the display will change to indicate the volume level.

- Press **MENU** or **ENTER** to save changes and return to the previous screen.

Set the Program Maximum Volume

The Program Maximum Volume control is used to set the highest volume setting of the **PROGRAM** output. The **RECORD** and **SPEECH** outputs are not affected by changes made to the Program Maximum Volume level.

To set the Program Maximum Volume level:

- Access the Program Output menu as described on page 37.
- Press the ▲ or ▼ buttons until “Max Volume” is displayed on the LCD and press **ENTER** to open the Program Maximum Volume controls.

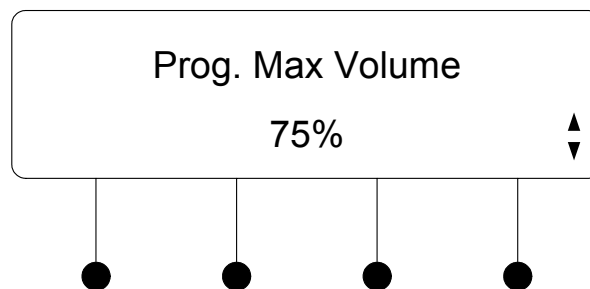
Program Maximum Volume Control

- Adjust the Program Maximum Volume level with the ▼ and ▲ buttons. Press the ▲ button to increase the Program Maximum Volume level. Press the ▼ button to lower the Program Maximum Volume level. The lowest Program Maximum Volume setting is 50%.

NOTE: While adjusting the Program Maximum Volume level, the Program Volume level can be adjusted by turning the volume control clockwise to raise the volume, or counterclockwise to lower the volume. When adjusting the volume, the display will change to indicate the volume level.

- Press **MENU** or **ENTER** to save changes and return to the previous screen.

Set the Stereo / Mono Mode

The Stereo / Mono controls are used to set the **PROGRAM** output mode. The audio sent to the speaker outputs can be set for either stereo or mono. When set to stereo, the audio signal is separated into left and right channels for distribution to left and right speakers or amplifier channels. When set to mono, the audio signal is combined into one signal for use in larger rooms where stereo separation is not practical. The **RECORD** and **SPEECH** outputs are not affected by changes to the stereo/mono mode.

To set the Stereo / Mono mode:

- Access the Program Output menu as described on page 37.
- Press the ▲ or ▼ buttons until “Stereo/Mono” is displayed on the LCD and press **ENTER** to open the Stereo / Mono controls as shown in the following diagram.

Stereo / Mono Control

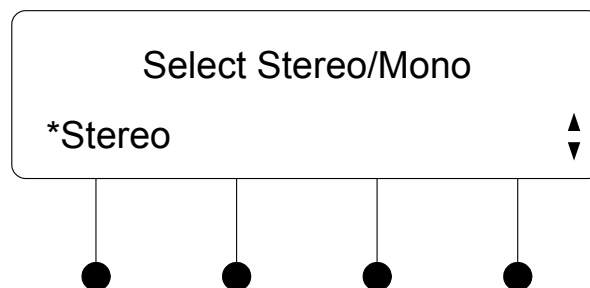

- Press the ▲ or ▼ buttons until the desired mode is displayed on the LCD and press **ENTER**. The current setting is indicated with an asterisk (*).

NOTE: While adjusting the Stereo/Mono setting, the Program Volume level can be adjusted by turning the volume control clockwise to raise the volume, or counterclockwise to lower the volume. When adjusting the volume, the display will change to indicate the volume level.

- Press **ENTER** to save changes and return to the Program Output menu. To cancel without saving changes, press **MENU**.

Adjust the Program Startup Volume

The Program Startup Volume control is used to establish the **PROGRAM** output's volume level setting when an input is selected. The **RECORD** and **SPEECH** outputs are not affected by changes made to the Program Startup Volume level.

To adjust the Program Startup Volume level:

- Access the Program Output menu as described on page 37.

- Press the ▲ or ▼ buttons until “Startup Vol.” is displayed on the LCD and press **ENTER** to open the Program Startup Volume control.

Program Startup Volume Control

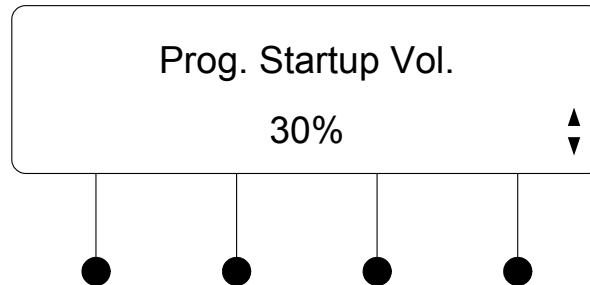

- Adjust the Program Startup Volume level with the ▼ and ▲ buttons. Press the ▲ button to increase the startup volume level. Press the ▼ button to lower the startup volume level. The highest Program Startup Volume setting is 100%.

NOTE: While adjusting the Program Startup Volume level, the Program Volume level can be adjusted by turning the volume control clockwise to raise the volume, or counterclockwise to lower the volume. When adjusting the volume, the display will change to indicate the volume level.

- Press **MENU** or **ENTER** to save changes and return to the previous screen.

Speech Output

The *Speech Output* section of the Audio Setup menu is used to set the **SPEECH** output’s volume level, source mix, bass, treble, speech delay, minimum volume, maximum volume, and startup volume. The **PROGRAM** and **RECORD** outputs are not affected by changes made from the Speech Output menu.

Access the Speech Output Menu

To access the Speech Output menu:

- Access the Audio Setup menu as described on page 37. The words “Audio Setup” will be displayed.
- Press the ▲ or ▼ buttons until “Speech Output” is displayed on the LCD and press **ENTER** to open the Speech Output menu.
- To return to the Audio Setup menu, press **MENU**.

Set the Speech Volume Level

To set the Speech Volume level:

- Access the Speech Output menu as described above.
- Adjust the Speech Volume level by turning the volume control clockwise to raise the volume, or counterclockwise to lower the volume. When adjusting the volume, the display will change to indicate the volume level.

Set the Speech Source Mix

To set the **SPEECH** output’s source mix:

- Access the Speech Output menu as described above.
- Press the ▲ or ▼ buttons until “Source Mix” is displayed on the LCD and

press **ENTER** to open the Speech Source Mix controls.

Speech Source Mix Controls



- Press the ▲ or ▼ buttons until the desired setting is displayed on the LCD. The current setting is indicated with an asterisk (*). The following settings are available:
 - ⇒ **Aud. Only**: Sends the audio signal from the selected source to the **SPEECH** output.
 - ⇒ **Mic. Only**: Sends the microphone input signals to the **SPEECH** output.
 - ⇒ **Mic + Aud**: Sends a mix of the audio signal from the selected source and the microphone input signals to the **SPEECH** output.

NOTE: While setting the Speech Source Mix, the Speech Volume level can be adjusted by turning the volume control clockwise to raise the volume, or counterclockwise to lower the volume. When adjusting the volume, the display will change to indicate the volume level.

- Press **ENTER** to save changes and return to the previous screen. To cancel without saving changes, press **MENU**.

Set the Speech Bass Level

To set the Speech Bass level:

- Access the Speech Output menu as described on page 42.
- Press the ▲ or ▼ buttons until “Bass” is displayed on the LCD and press **ENTER** to open the Speech Bass controls. The current bass level will be displayed.

Speech Bass Controls

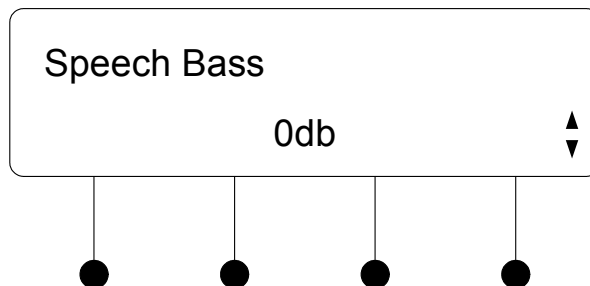

- Adjust the Speech Bass level with the ▼ and ▲ buttons. Press the ▲ button to increase the Speech Bass level. Press the ▼ button to lower the Speech Bass level.

NOTE: While adjusting the Speech Bass level, the Speech Volume level can be adjusted by turning the volume control clockwise to raise the volume, or counterclockwise to lower the volume. When adjusting the volume, the display will change to indicate the volume level.

- Press **MENU** or **ENTER** to save changes and return to the previous screen.

Set the Speech Treble Level

To set the Speech Treble level:

- Access the Speech Output menu as described on page 42.
- Press the ▲ or ▼ buttons until “Treble” is displayed on the LCD and press **ENTER** to open the Speech Treble controls. The current treble level will be displayed.

Speech Treble Control

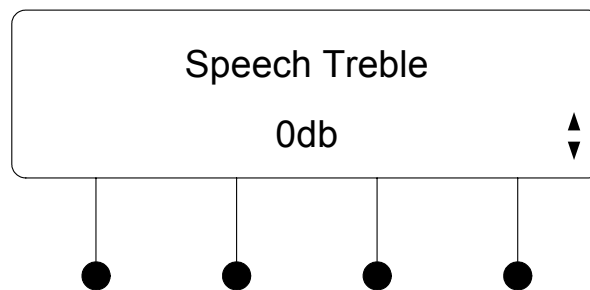

- Adjust the Speech Treble level with the ▼ and ▲ buttons. Press the ▲ button to increase the Speech Treble level. Press the ▼ button to lower the Speech Treble level.

NOTE: While adjusting the Speech Treble level, the Speech Volume level can be adjusted by turning the volume control clockwise to raise the volume, or counterclockwise to lower the volume. When adjusting the volume, the display will change to indicate the volume level.

- Press **MENU** or **ENTER** to save changes and return to the previous screen.

Set the Speech Delay

To set the Speech Delay:

- Access the Speech Output menu as described on page 42.
- Press the ▲ or ▼ buttons until “Speech Delay” is displayed on the LCD and press **ENTER** to open the Speech Delay controls. The current speech delay will be displayed.

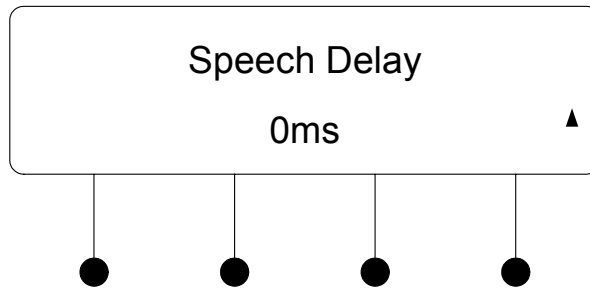
Speech Delay Control

- Adjust the Speech Delay with the ▼ and ▲ buttons. Press the ▲ button to increase the delay. Press the ▼ button to lower the delay. The highest delay setting is 40 milliseconds.

NOTE: While adjusting the Speech Delay, the Speech Volume level can be adjusted by turning the volume control clockwise to raise the volume, or counterclockwise to lower the volume. When adjusting the volume, the display will change to indicate the volume level.

- Press **MENU** or **ENTER** to save changes and return to the previous screen.

Change the Volume Control Mode

The operating mode of the volume control knob can be set to adjust the program volume, the speech volume, user-selectable program/speech volume, or the master volume. To change the Volume Control Mode:

- Access the Speech Output menu as described on page 42.
- Press the ▲ or ▼ buttons until “Prog/Spch Vol.” is displayed on the LCD and press **ENTER** to open the Volume Control Mode controls.

Volume Control Mode Control

- Press the ▲ or ▼ buttons until the desired mode is displayed on the LCD and press **ENTER**. The current setting is indicated with an asterisk (*). The following settings are available:
 - ⇒ **Program Only:** The front panel volume control will now only control the output volume for **PROG OUT** (and **SPEAKER 20W 8Ω** if the internal amplifier is used).
 - ⇒ **Speech Only:** The front panel volume control will now only control the output volume for **SPEECH OUT**.

- ⇒ **Pgm/Spch Sel.:** The front panel volume control will allow the user to select during operation if the knob affects the volume of **PROG OUT** or **SPEECH OUT**.
- ⇒ **Master Vol.:** The front panel volume control will control the master volume level, raising both the **PROG OUT** and **SPEECH OUT** volumes simultaneously while retaining their current proportional levels.

NOTE: While setting the Volume Control Mode, the Speech Volume level can be adjusted by turning the volume control clockwise to raise the volume, or counterclockwise to lower the volume. When adjusting the volume, the display will change to indicate the volume level.

- Press **ENTER** to save changes and return to the Speech Output menu. To cancel without saving changes, press **MENU**.

The MPS-200 ships with the Volume Control Mode set to the **Master Vol.** setting. When switching the Volume Control Mode from the **Master Vol.** setting to either the **Program Only** setting, the **Speech Only** setting, or the user selectable **Pgm/Spch Sel.** setting, the Minimum and Maximum Volume levels for the **SPEECH** and **PROGRAM** outputs must be set to ensure proper operation.

- Set the Volume Control Mode to **Program Only**, **Speech Only**, or **Pgm/Spch Sel.** as described on page 45.
- Set the **PROGRAM** output's Minimum and Maximum Volume levels to 30% and 70% (respectively) as described in the instructions on pages 39 and 40.
- Set the **SPEECH** output's Minimum and Maximum Volume levels to 30% and 70% (respectively) as described on page 47.
- Set the Startup Volume levels for the **PROGRAM** and **SPEECH** outputs to 30% as described on pages 41 and 48.
- Set the Master Startup Volume to 100% to obtain the maximum dynamic range for the installation. Refer to the instructions on page 52.
- Raise or lower the Startup Volume levels for the **PROGRAM** and **SPEECH** outputs as necessary. These levels will determine the volume level of the system each time it is turned on.

If the Volume Control Mode is to be returned to the **Master Vol.** setting from the **Program Only** setting, the **Speech Only** setting, or the user selectable **Pgm/Spch Sel.** setting, the Minimum and Maximum Volume levels for the **SPEECH** and **PROGRAM** outputs must be set to ensure proper operation.

- Set the Volume Control Mode to **Master Vol.** as described on page 45.
- Set the **PROGRAM** output's Minimum and Maximum Volume levels to 30% and 70% (respectively) as described in the instructions on pages 39 and 40.
- Set the **SPEECH** output's Minimum and Maximum Volume levels to 30% and 70% (respectively) as described on page 47.
- Set the Startup Volume levels of the "loudest" outputs (**PROGRAM** or **SPEECH**) to 100% as described on pages 41 and 48 so maximum dynamic range is available.

- Set the Master Startup Volume to the desired level (will probably be less than 50%). Refer to the instructions on page 52.

Set the Speech Minimum Volume

The Speech Minimum Volume control is used to set the lowest volume setting of the **SPEECH** output. The **RECORD** and **PROGRAM** outputs are not affected by changes made to the Speech Minimum Volume level.

To set the Speech Minimum Volume level:

- Access the Speech Output menu as described on page 42.
- Press the ▲ or ▼ buttons until “Min Volume” is displayed on the LCD and press **ENTER** to open the Speech Minimum Volume controls.

Speech Minimum Volume Control

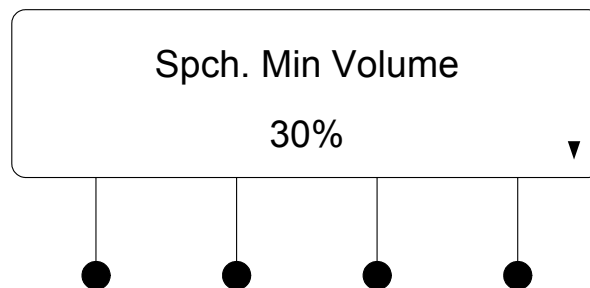

- Adjust the Speech Minimum Volume level with the ▼ and ▲ buttons. Press the ▲ button to increase the Speech Minimum Volume level. Press the ▼ button to lower the Speech Minimum Volume level. The highest Speech Minimum Volume setting is 30%.

NOTE: While adjusting the Speech Minimum Volume level, the Speech Volume level can be adjusted by turning the volume control clockwise to raise the volume, or counterclockwise to lower the volume. When adjusting the volume, the display will change to indicate the volume level.

- Press **MENU** or **ENTER** to save changes and return to the previous screen.

Set the Speech Maximum Volume

The Speech Maximum Volume control is used to set the highest volume setting of the **SPEECH** output. The **RECORD** and **PROGRAM** outputs are not affected by changes made to the Speech Maximum Volume level.

To set the Speech Maximum Volume level:

- Access the Speech Output menu as described on page 42.
- Press the ▲ or ▼ buttons until “Max Volume” is displayed on the LCD and press **ENTER** to open the Speech Maximum Volume controls.

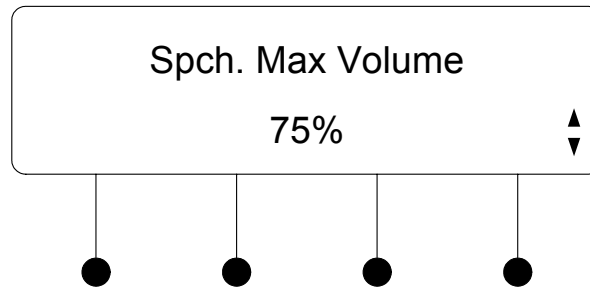
Speech Maximum Volume Control

- Adjust the Speech Maximum Volume level with the ▼ and ▲ buttons. Press the ▲ button to increase the Speech Maximum Volume level. Press the ▼ button to lower the Speech Maximum Volume level. The lowest Speech Maximum Volume setting is 50%.

NOTE: While adjusting the Speech Maximum Volume level, the Speech Volume level can be adjusted by turning the volume control clockwise to raise the volume, or counterclockwise to lower the volume. When adjusting the volume, the display will change to indicate the volume level.

- Press **MENU** or **ENTER** to save changes and return to the previous screen.

Adjust the Speech Startup Volume

The Speech Startup Volume control is used to establish the **SPEECH** output's volume level setting when an input is selected. The **RECORD** and **PROGRAM** outputs are not affected by changes made to the Speech Startup Volume level.

To adjust the Speech Startup Volume level:

- Access the Speech Output menu as described on page 42.
- Press the ▲ or ▼ buttons until "Startup Vol." is displayed on the LCD and press **ENTER** to open the Speech Startup Volume control.

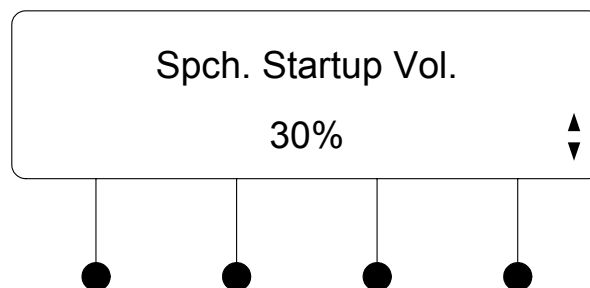
Speech Startup Volume Control

- Adjust the Speech Startup Volume level with the ▼ and ▲ buttons. Press the ▲ button to increase the Speech Startup Volume level. Press the ▼ button to lower the Speech Startup Volume level. The highest Speech Startup Volume setting is 100%.

NOTE: While adjusting the Speech Startup Volume level, the Speech Volume level can be adjusted by turning the volume control clockwise to raise the volume, or counterclockwise to lower the volume. When adjusting the volume, the display will change to indicate the volume level.

- Press **MENU** or **ENTER** to save changes and return to the previous screen.

Record Output

The *Record Output* section of the Audio Setup menu is used to set the **RECORD** output's volume level, source mix, output mode, and startup volume. The **PROGRAM** and **SPEECH** outputs are not affected by changes made to the Record Output controls.

Access the Record Output Menu

To access the Record Output menu:

- Access the Audio Setup menu as described on page 37. The words "Audio Setup" will be displayed.
- Press the ▲ or ▼ buttons until "Record Output" is displayed on the LCD and press **ENTER** to open the Record Output menu.
- To return to the Audio Setup menu, press **MENU**.

Set the Record Volume Level

To set the Record Volume level:

- Access the Record Output menu as described above.
- Adjust the Record Volume level by turning the volume control clockwise to raise the volume, or counterclockwise to lower the volume. When adjusting the Record Volume level, the display will change to indicate the volume level.

NOTE: The Record Volume can only be used if the Fixed/Variable Mode is set to "Variable". For more information, refer to "Set Fixed/Variable Mode on page 50."

Set the Record Source Mix

To set the **RECORD** output's source mix:

- Access the Record Output menu as described above.
- Press **ENTER** to open the Record Source Mix controls.

Record Source Mix Controls

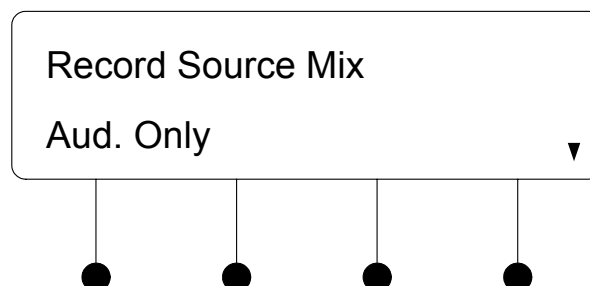

- Press the ▲ or ▼ buttons until the desired setting is displayed on the LCD. The current setting is indicated with an asterisk (*). The following settings are available:
 - ⇒ **Aud. Only**: Sends the audio signal from the selected source to the **RECORD** output.
 - ⇒ **Mic. Only**: Sends the microphone input signals to the **RECORD** output.
 - ⇒ **Mic + Aud**: Sends a mix of the audio signal from the selected source and the microphone input signals to the **RECORD** output.

NOTE: While setting the Record Source Mix, the Record Volume level can be adjusted by turning the volume control clockwise to raise the volume, or counterclockwise to lower the volume. When adjusting the volume, the display will change to indicate the volume level.

- Press **ENTER** to save changes and return to the previous screen. To cancel without saving changes, press **MENU**.

Set Fixed/Variable Mode

The **RECORD** output can be set to operate at a fixed level or a variable level. The **SPEECH** and **PROGRAM** outputs are not affected by changes made to the Fixed/Variable mode.

To adjust the Fixed/Variable Mode:

- Access the Record Output menu as described on page 49.
- Press the ▲ or ▼ buttons until “Fixed/Variable” is displayed on the LCD and press **ENTER** to open the Fixed/Variable control.

Fixed/Variable Control

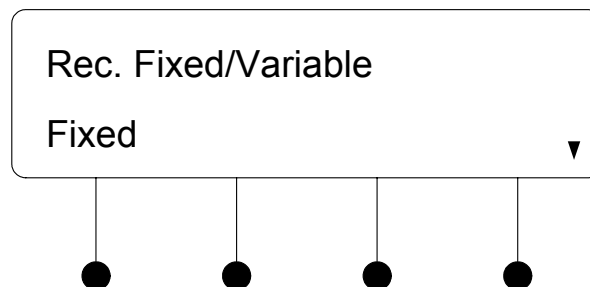

- Press the ▲ or ▼ buttons until the desired setting is displayed on the LCD. The current setting is indicated with an asterisk (*). The following settings are available:
 - ⇒ **Fixed**: The **RECORD** output operates at a fixed level.
 - ⇒ **Variable**: The **RECORD** output operates at a variable level.
- Press **ENTER** to save changes and return to the previous screen. To cancel without saving changes, press **MENU**.

Adjust the Record Startup Volume

The Record Startup Volume control is used to establish the **RECORD** output's volume level setting when an input is selected. The **SPEECH** and **PROGRAM** outputs are not affected by changes made to the Record Startup Volume level.

NOTE: The Record Volume can only be used if the Fixed/Variable Mode is set to "Variable". For more information, refer to "Set Fixed/Variable Mode on page 50.

To adjust the Record Startup Volume level:

- Access the Record Output menu as described on page 49.
- Press the ▲ or ▼ buttons until "Startup Vol." is displayed on the LCD and press **ENTER** to open the Record Startup Volume control.

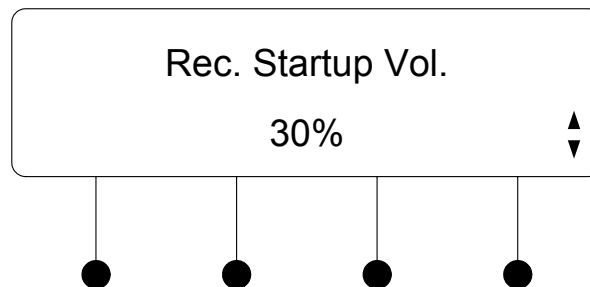
Record Startup Volume Control

- Adjust the Record Startup Volume level with the ▼ and ▲ buttons. Press the ▲ button to increase the Record Startup Volume level. Press the ▼ button to lower the Record Startup Volume level. The highest Record Startup Volume setting is 100%.

NOTE: While adjusting the Record Startup Volume level, the Record Volume level can be adjusted by turning the volume control clockwise to raise the volume, or counterclockwise to lower the volume. When adjusting the volume, the display will change to indicate the volume level.

- Press **MENU** or **ENTER** to save changes and return to the previous screen.

Input Compensation

The compensation level of each input can be set from the MPS-200's front panel. The line outputs are not affected by changes made to the input compensation level.

Set the Compensation Level

To set the compensation level for an input:

- Access the Audio Setup menu described on page 37.
- Press the ▲ or ▼ buttons until "Input Compensation" is displayed on the LCD and press **ENTER** to open the Select Input to Compensate controls as shown in the following diagram.

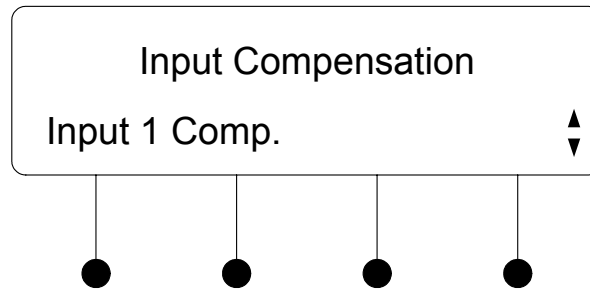
Select Input to Compensate

- To select the input to compensate, press the ▲ or ▼ buttons until the desired input is displayed and press **ENTER**.

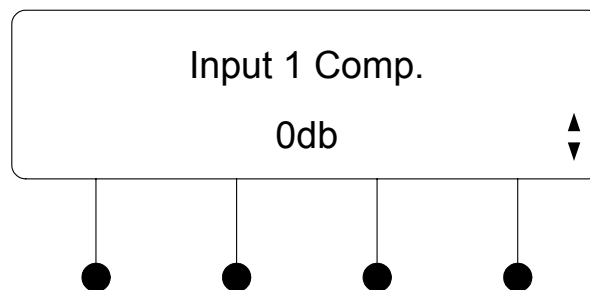
Adjust Compensation Level

- Adjust the compensation level with the ▼ and ▲ buttons. Press the ▲ button to increase the compensation level. Press the ▼ button to lower the compensation level. Compensation can range from -10db to 10db. A compensation level of 0db will provide neutral compensation.

NOTE: While adjusting the compensation level, the master volume level can be adjusted by turning the volume control clockwise to raise the volume, or counterclockwise to lower the volume. When adjusting the volume, the display will change to indicate the volume level.

- Press **MENU** or **ENTER** to save changes and return to the Select Input to Compensate controls.
- Repeat for each input to be adjusted.
- Press **MENU** to save changes and return to the Audio Setup menu.

Master Startup Volume Control

The Master Startup Volume control is used to establish the volume level setting when an input is selected. The **RECORD** output is not affected by changes made to the Master Startup Volume level.

Adjust the Master Startup Volume

To adjust the Master Startup Volume control:

- Access the Audio Setup menu as described on page 37.
- Press the ▲ or ▼ buttons until “Master Startup Vol.” is displayed on the LCD and press **ENTER** to open the Master Startup Volume control.

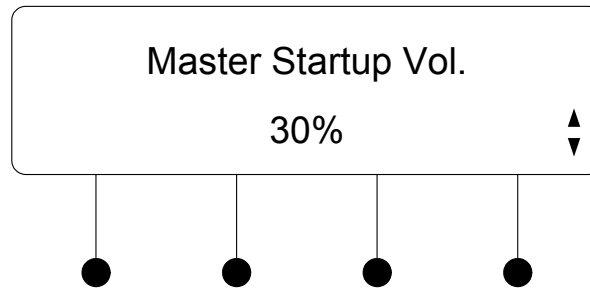
Master Startup Volume Control

- Adjust the Master Startup Volume level with the ▼ and ▲ buttons. Press the ▲ button to increase the Master Startup Volume level. Press the ▼ button to lower the Master Startup Volume level. The highest Master Startup Volume setting is 100%.

NOTE: While adjusting the Master Startup Volume level, the Master Volume level can be adjusted by turning the volume control clockwise to raise the volume, or counterclockwise to lower the volume. When adjusting the volume, the display will change to indicate the volume level.

- Press **MENU** or **ENTER** to save changes and return to the previous screen.

Microphones

The MPS-200 can be connected to two microphones that are channeled to the **SPEECH** outputs and can be incorporated into the **RECORD** and **PROGRAM** outputs. The microphone inputs feature switchable gating and can provide phantom power to microphones requiring phantom power.

Access the Microphone Menu

To access the Microphone menu:

- Access the Audio Setup menu as described on page 37.
- Press the ▲ or ▼ buttons until “Microphones” is displayed on the LCD and press **ENTER** to open the Microphones menu.
- To return to the Audio Setup menu, press **MENU**.

Switch Microphone Gating

Microphone gating can be individually set on each microphone input. To switch microphone gating on or off:

- Access the Microphone menu as described above.
- Press the ▲ or ▼ buttons until “Mic 1 Gating” or “Mic 2 Gating” is displayed on the LCD and press **ENTER** to open the Microphone Gating control.

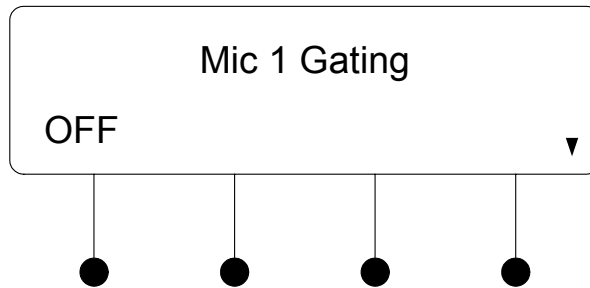
Microphone Gating Control (MIC 1 shown)

- Press the ▲ or ▼ buttons until the desired setting is displayed on the LCD and press **ENTER** to save the setting. The current setting is indicated with an asterisk (*). The following settings are available:
 - ⇒ **OFF**: The gating function for the selected microphone input is disabled.
 - ⇒ **ON**: The gating function for the selected microphone input is enabled.
- To exit the Microphone Gating control without saving changes, press **MENU**.

Switch Phantom Power

Phantom power for the microphone inputs can be switched on or off. To switch phantom power on or off:

- Access the Microphone menu as described on page 53.
- Press the ▲ or ▼ buttons until “Phantom Power” is displayed on the LCD and press **ENTER** to open the Phantom Power control.

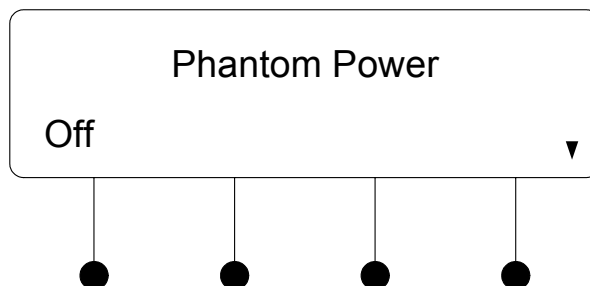
Phantom Power Control

- Press the ▲ or ▼ buttons until the desired setting is displayed on the LCD and press **ENTER** to save the setting. The current setting is indicated with an asterisk (*). The following settings are available:
 - ⇒ **OFF**: Phantom power to the microphone inputs is disabled.
 - ⇒ **ON**: Phantom power to the microphone inputs is enabled.
- To exit the Phantom Power control without saving changes, press **MENU**.

Adjust Microphone Gain

The gain for each microphone input can be individually set. To adjust the gain of a microphone input:

- Access the Microphone menu as described on page 53.

- Press the ▲ or ▼ buttons until “Mic 1 Gain” or “Mic 2 Gain” is displayed on the LCD and press **ENTER** to open the Microphone Gain control.

Microphone Gain Control (MIC 1 shown)

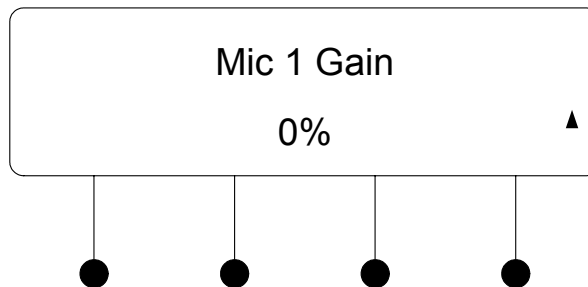

- Press the ▲ or ▼ buttons until the desired setting is displayed on the LCD and press **ENTER** to save the setting.
- To exit the Microphone Gain control without saving changes, press **MENU**.

Video Setup

The video characteristics of the MPS-200 can be configured from the front panel using the Video Setup menu.

Access the Video Setup Menu

To access the Video Setup menu:

- Access the menu as described on page 35. Press the ▲ or ▼ buttons until “Video Setup” is displayed on the LCD.
- Press **ENTER** to open the Video Setup menu.
- To exit the Video Setup menu, press **MENU**.

Name Video Inputs

The MPS-200 ships with default names assigned to each of the inputs. Input 1 is called “BNC 1”. Input 2 is called “BNC 2”. Input 3 is called “BNC 3”. Input 4 is called “BNC 4”. Input 5 is called “RGBHV 5”. Input 6 is called “RGBHV 6”. Input 7 is called “RGBHV 7”. Input 8 is called “RGBHV 8”. To change the input names:

- Access the Video Setup menu as described above.
- Press the ▲ or ▼ buttons until “Input Names” is displayed on the LCD and press **ENTER** to open the Input Naming menu.

Select Input to Name

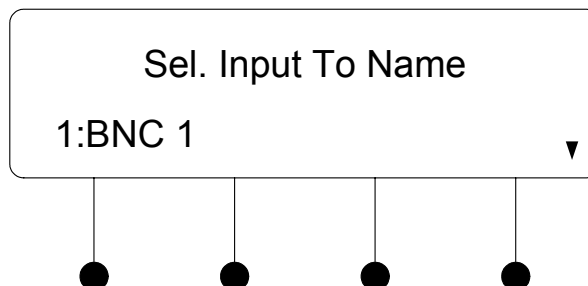

- Press the ▲ or ▼ buttons until the input to be named is displayed on the LCD and press **ENTER**. The cursor is placed after the last character in the input name.

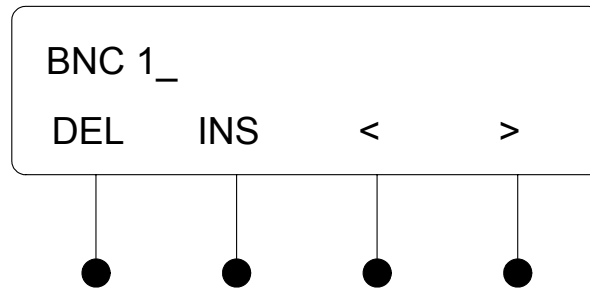
Name the Input

- Turn the volume control clockwise or counterclockwise (or press the ▲ or ▼ buttons) to select a new letter (uppercase or lowercase) or number. Move the cursor by pressing the soft buttons labeled < or >. Each input name can be up to 14 characters in length. To delete a character, position the cursor under the character to be deleted and press the soft button labeled **DEL**. To insert a space, position the cursor where the space is to be inserted and press the soft button labeled **INS**.
- Press **ENTER** to save the new name and return to the Input Naming menu or press **MENU** to cancel the operation and return to the Input Naming menu.
- After all inputs have been named, press **MENU** to return to the Video Setup menu.

Select Input Type

The four BNC video inputs of the MPS-200 can accept composite, S-video, or component signals. Specifying the input signal type determines which of the output connectors receives the selected input signal. To specify the signal types expected by each of the inputs:

- Access the Video Setup menu as described on page 55.
- Press the ▲ or ▼ buttons until “Input Types” is displayed on the LCD and press **ENTER** to open the Input Type menu.

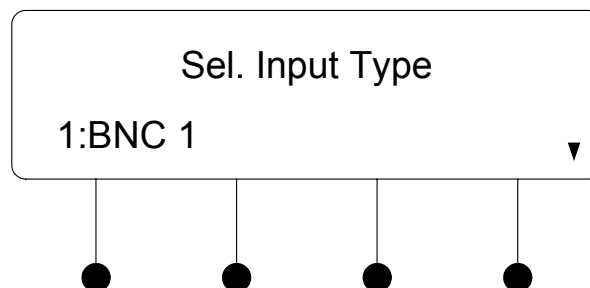
Select Input Type Menu

- Press the ▲ or ▼ buttons to select the video input to be configured and press **ENTER**. The current setting is indicated with an asterisk (*).
- Press the ▲ or ▼ buttons until the desired input type is displayed.

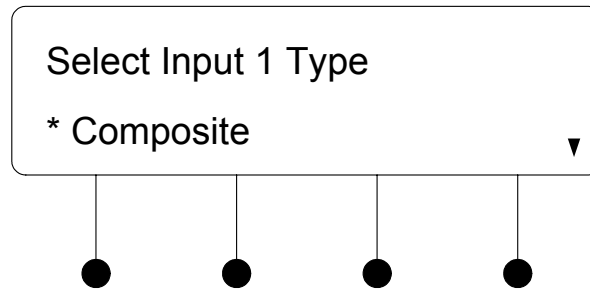
Select Input Type

- Press **ENTER** to save the input type and return to the Select Input Type menu or press **MENU** to cancel the operation and return to the Select Input Type menu.
- After all inputs have been configured, press **MENU** to return to the Video Setup menu.

Name Video Outputs

The MPS-200 ships with default names assigned to each of the outputs. Output 1 is called "PROJECTOR". Output 2 is called "TOUCHPANEL". To change the output names:

- Access the Video Setup menu as described on page 55.
- Press the ▲ or ▼ buttons until "Output Names" is displayed on the LCD and Press **ENTER** to open the Output Naming menu.

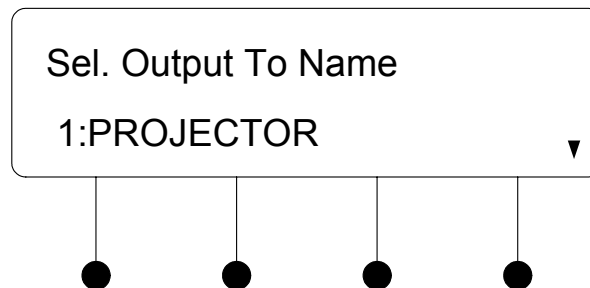
Select Output to Name

- Press the ▲ or ▼ buttons until the output to be named is displayed on the LCD and press **ENTER**. The cursor is placed after the last character in the output name.

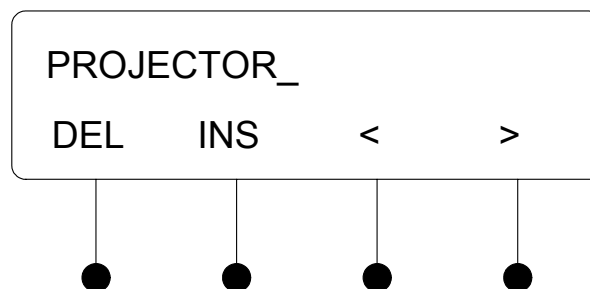
Name the Output

- Turn the volume control clockwise or counterclockwise (or press the ▲ or ▼ buttons) to select a new letter (uppercase or lowercase) or number. Move the cursor by pressing the soft buttons labeled < or >. Each output name can be up to 14 characters in length. To delete a character, position the cursor under the character to be deleted and press the soft button labeled **DEL**. To insert a space, position the cursor where the space is to be inserted and press the soft button labeled **INS**.
- Press **ENTER** to save the new name and return to the Output Naming menu or press **MENU** to cancel the operation and return to the Output Naming menu.
- After all outputs have been named, press **MENU** to return to the Video Setup menu.

Network Setup

The network settings of the MPS-200 can be configured and reviewed from the front panel using the Network Setup menu.

NOTE: Some changes to network settings may require a reboot to take effect. The system will automatically reboot when necessary.

Access the Network Setup Menu

To access the Network Setup menu:

- Access the menu as described on page 35. Press the ▲ or ▼ buttons until “Network Setup” is displayed on the LCD.
- Press **ENTER** to open the Network Setup menu.
- To exit the Network Setup menu, press **MENU**.

Set the IP Address

The MPS-200 uses TCP/IP communications for communications between network devices, a PC, and RoomView Help Desk software. The IP address can be manually set or obtained from a DHCP server. For information on using DHCP to obtain an IP address, refer to “Set the DHCP Mode” on page 60. To manually set an IP address:

- Access the Network Setup menu as described above.
- Press the ▲ or ▼ buttons until “IP Address” is displayed on the LCD and press **ENTER** to display the IP Address controls. The current IP address will be displayed.

Display the IP Address

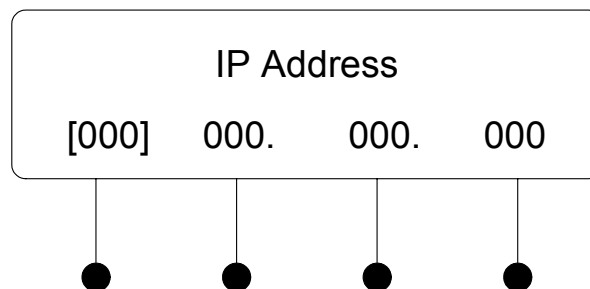

- Turn the volume control clockwise or counterclockwise to select a number in the left-most section of the IP address. You can also press the ▲ or ▼ buttons to select a number.

- Press **ENTER** to move the cursor to the next section of the address. To change a different section, press the soft button under the section to be changed.
- Repeat the previous two steps until the entire IP address is set.
- To save the new address and return to the Network Setup menu, move the cursor to the right-most section and press **ENTER**. To cancel the operation and return to the Network Setup menu, press **MENU**.

Set the Subnet Mask

The MPS-200 can be configured to use an IP Subnet Mask for TCP/IP communications. To set the address of the IP Subnet Mask:

- Access the Network Setup menu as described on page 58.
- Press the ▲ or ▼ buttons until “Subnet Mask” is displayed on the LCD and press **ENTER** to display the Subnet Mask controls. The current IP address of the Subnet Mask will be displayed.

Display the IP Subnet Mask Address

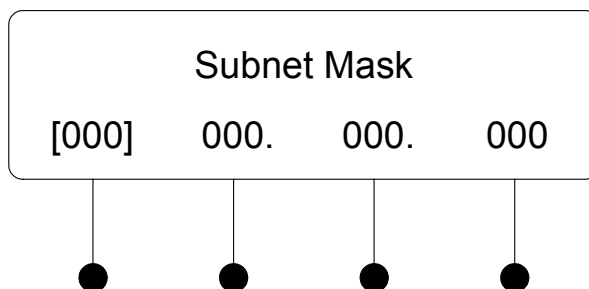

- Turn the volume control clockwise or counterclockwise to select a number. You can also press the ▲ or ▼ buttons to select a number.
- Press **ENTER** to move the cursor to the next section of the address. To change a different section, press the soft button under the section to be changed.
- Repeat the previous two steps until the entire Subnet Mask IP address is set.
- To save the new address and return to the Network Setup menu, move the cursor to the right-most section and press **ENTER**. To cancel the operation and return to the Network Setup menu, press **MENU**.

Set the Default Router

The MPS-200 can be configured to use a Default Router for TCP/IP communications. To set the IP address of the Default Router:

- Access the Network Setup menu as described on page 58.
- Press the ▲ or ▼ buttons until “Def. Router” is displayed on the LCD and press **ENTER** to display the Default Router controls. The current IP address of the Default Router will be displayed.

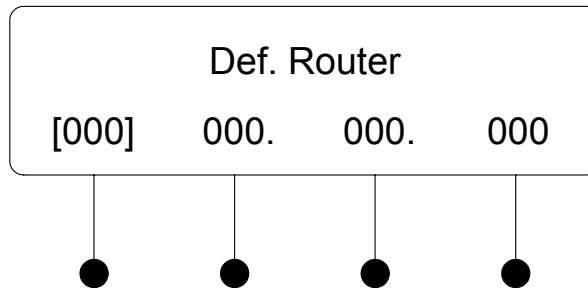
Display the Default Router Address

- Turn the volume control clockwise or counterclockwise to select a number. You can also press the ▲ or ▼ buttons to select a number.
- Press **ENTER** to move the cursor to the next section of the address. To change a different section, press the soft button under the section to be changed.
- Repeat the previous two steps until the entire Default Router IP address is set.
- To save the new address and return to the Network Setup menu, move the cursor to the right-most section and press **ENTER**. To cancel the operation and return to the Network Setup menu, press **MENU**.

Set the DHCP Mode

The IP address can be obtained from a DHCP server or manually set. For information on manually setting the IP address, refer to “Set the IP Address” on page 58. To set the DHCP mode:

- Access the Network Setup menu as described on page 58.
- Press the ▲ or ▼ buttons until “DHCP” is displayed on the LCD and press **ENTER** to display the DHCP controls.

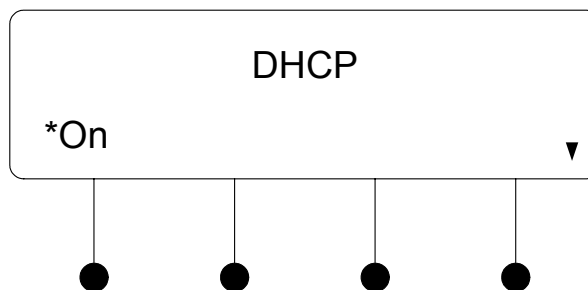
DHCP Settings

- Press ▲ and ▼ buttons to toggle between On and Off. The current setting is indicated with an asterisk (*).
- To save the setting and return to the Network Setup menu, press **ENTER**. To cancel the operation and return to the Network Setup menu, press **MENU**.

Set the WINS Mode

The MPS-200 can use a WINS server to obtain an IP address. To set the WINS mode:

- Access the Network Setup menu as described on page 58.
- Press the ▲ or ▼ buttons until “WINS” is displayed on the LCD and press **ENTER** button to display the WINS controls.

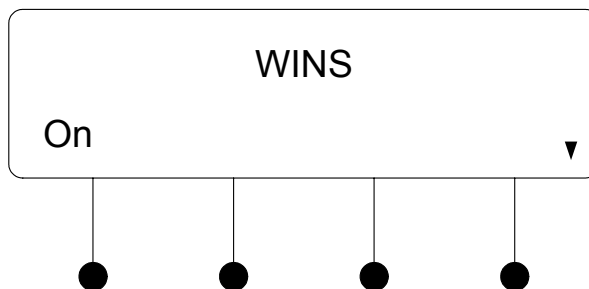
Display the WINS Mode

- Press the ▲ and ▼ buttons to toggle between On and Off. The current setting is indicated with an asterisk (*).
- To save the setting and return to the Network Setup menu, press **ENTER**. To cancel the operation and return to the Network Setup menu, press **MENU**.

View and Set the Hostname

The MPS-200 can be recognized by its hostname in a networked environment. To view and set the hostname:

- Access the Network Setup menu as described on page 58.
- Press the ▲ or ▼ buttons until “HostName” is displayed on the LCD and press **ENTER** to display the Hostname controls. The current Hostname will be displayed.

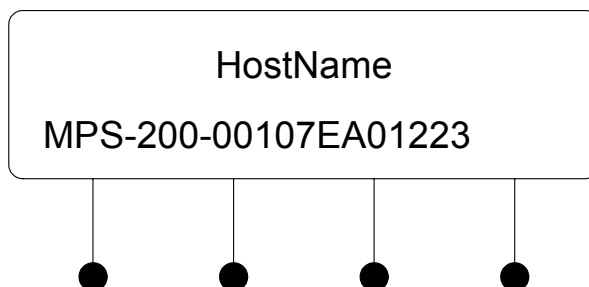
Display the Hostname

- Press **ENTER** to change the Hostname. A cursor is placed after the last character in the Hostname.

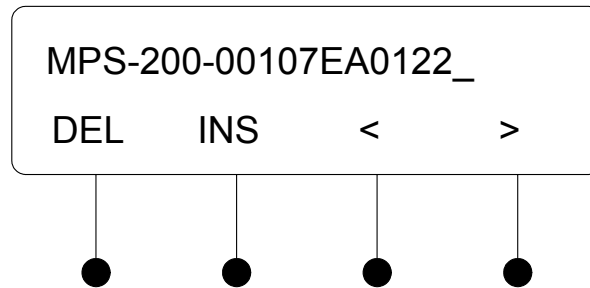
Change the Hostname

- Turn the volume control clockwise or counterclockwise (or press the ▲ or ▼ buttons) to select a new letter (uppercase or lowercase) or number. Move the cursor by pressing the soft buttons labeled < or >. The Hostname can be up to 64 characters in length. To delete a character, position the cursor under the character to be deleted and press the soft button labeled **DEL**. To insert a space, position the cursor where the space is to be inserted and press the soft button labeled **INS**.
- To save the new name and return to the Network Setup menu, press **ENTER**. To cancel the operation and return to the Hostname display, press **MENU**.

View and Set the Domain Name

Some networks may require a Domain name to resolve the hostname. To view and set the Domain name:

- Access the Network Setup menu as described on page 58.
- Press the ▲ or ▼ buttons until “Domain Name” is displayed on the LCD and press **ENTER** to display the Domain name controls. The current Domain name (if entered) will be displayed.

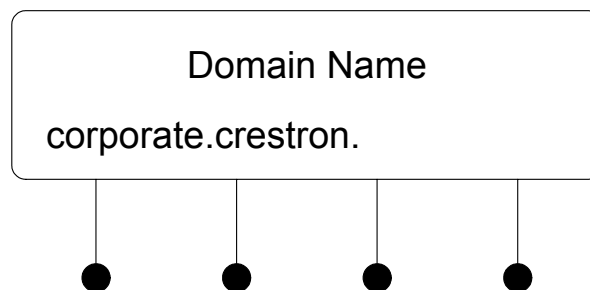
Display the Domain Name

- Press **ENTER** to change the Domain name. A cursor is placed after the last character in the Domain name.

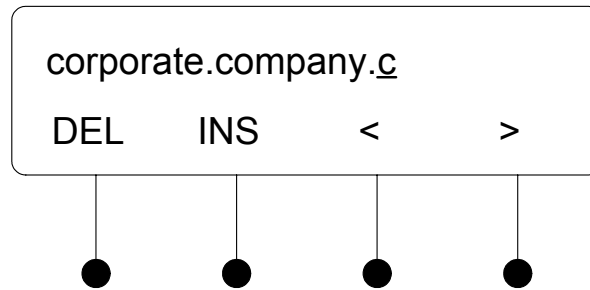
Change the Domain Name

- Turn the volume control clockwise or counterclockwise (or press the ▲ or ▼ buttons) to select a new letter (uppercase or lowercase) or number. Move the cursor by pressing the soft buttons labeled < or >. The Domain name can be up to 64 characters in length. To delete a character, position the cursor under the character to be deleted and press the soft button labeled **DEL**. To insert a space, position the cursor where the space is to be inserted and press the soft button labeled **INS**.
- To save the new name and return to the Network Setup menu, press **ENTER**. To cancel the operation and return to the Domain name display, press **MENU**.

Set the RoomView Mode

The MPS-200 can be configured to report to RoomView Express (formerly known as RoomView 6.0) or RoomView Server Edition (formerly known as RoomView 7.0). To set the version of RoomView:

- Access the Network Setup menu as described on page 58.
- Press the ▲ or ▼ buttons until “RoomView” is displayed on the LCD and press **ENTER** to display the RoomView controls.

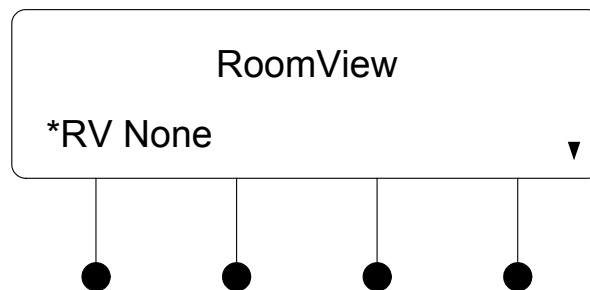
Display the RoomView Settings

- Press the ▲ and ▼ buttons to toggle between RV 6.0 (RoomView Express), RV 7.0 (RoomView Server Edition), or RV None. The current setting is indicated with an asterisk (*). When set to RoomView None, the MPS-200 will not report any status information.
- To save the setting and return to the Network Setup menu, press **ENTER**. To cancel the operation and return to the Network Setup menu, press **MENU**.

For more information on using RoomView, refer to the RoomView help file.

Display the MAC Address

The MPS-200 can display its MAC address. To view the MAC address:

- Access the Network Setup menu as described on page 58.
- Press the ▲ or ▼ buttons until “MAC Address” is displayed on the LCD and press **ENTER** to display the MAC address.
- Press **MENU** to return to the Network Setup menu.

Control Setup

Basic control system operations can be performed from the MPS-200 front panel using the Control Setup menu.

Access the Control Setup Menu

To access the Control Setup menu:

- Access the menu as described on page 35. Press the ▲ or ▼ buttons until “Control Setup” is displayed on the LCD.
- Press **ENTER** to open the Control Setup menu.
- To exit the Control Setup menu, press **MENU**.

Change the Backlight Level

The brightness of the LCD’s backlight can be adjusted for ease of viewing. To adjust the brightness level from the front panel:

- Access the Control Setup menu as described above.
- Press the ▲ or ▼ buttons until “Backlight” is displayed on the LCD and press **ENTER** to display the Select Brightness controls.

Display the Select Brightness Controls

- Press the ▼ or ▲ buttons to select a brightness level (low, medium, or high). The current level is indicated with an asterisk (*).
- To save the setting and return to the Control Setup menu, press **ENTER**. To cancel the operation and return to the Control Setup menu, press **MENU**.

Name the Function Buttons

The MPS-200 ships with default names assigned to each of the five function buttons. Button 1 is called “MUTE”. Button 2 is called “SCREEN DOWN”. Button 3 is called “SCREEN UP”. Button 4 is called “LIGHTS PRESET 1”. Button 5 is called “LIGHTS PRESET 2”. Function names can be changed from the front panel.

To change the function names:

- Access the Control Setup menu as described above.
- Press the ▲ or ▼ buttons until “Functions” is displayed on the LCD and press **ENTER** to display the Function Naming menu.

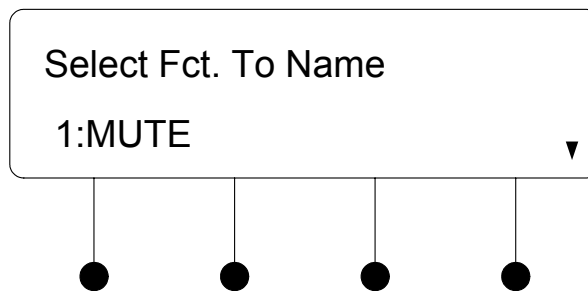
Select Function to Name

- Press the ▲ or ▼ buttons until the function to be named is displayed on the LCD and press **ENTER**. The cursor is placed after the last character in the function name.

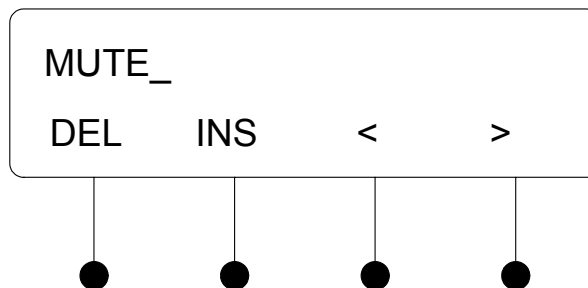
Name the Function

- Turn the volume control clockwise or counterclockwise (or press the ▲ or ▼ buttons) to select a new letter (uppercase or lowercase) or number. Move the cursor by pressing the soft buttons labeled < or >. Each function name can be up to 14 characters in length. To delete a character, position the cursor under the character to be deleted and press the soft button labeled **DEL**. To insert a space, position the cursor where the space is to be inserted and press the soft button labeled **INS**.
- Press **ENTER** to save the new name and return to the Function Naming menu or press **MENU** to cancel the operation and return to the Function Naming menu.
- After all functions have been named, press **MENU** to return to the Control Setup menu.

Identify Network Devices

Use the front panel to identify the presence of Cresnet devices such as APAD, C2N-DB12, CNX-B12, and C2N-FTB keypads, C2N-MNETGW gateways, CLS-C6 lighting systems, and QM-AMP amplifiers:

- Access the Control Setup menu as described on page 64.
- Press the ▲ or ▼ buttons until “Devices” is displayed on the LCD and press **ENTER**.
- The MPS-200 will poll the Cresnet network to detect Cresnet devices. The display will prompt the user to press **ENTER** to ID all devices.

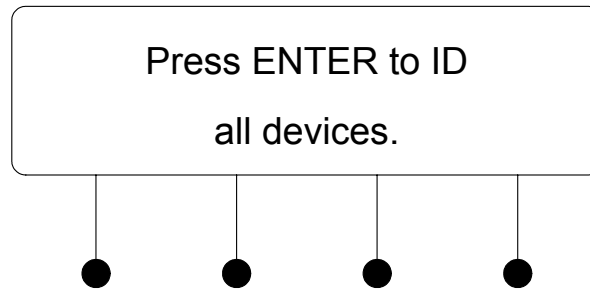
ID Devices Prompt

- Press **ENTER** to continue the identification process, the MPS-200 will clear all device settings and prompt the user to select the device type to be identified.

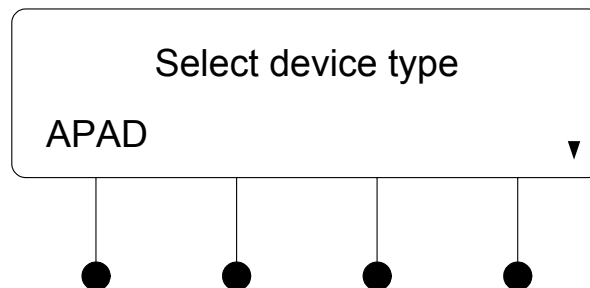
Select Device Type

- Press the ▲ or ▼ buttons until the device type to be identified is displayed on the LCD and press **ENTER**. The buttons (or SETUP LEDs) of the selected device type will flash. Press a button (or the SETUP button) on the selected device type to identify the device.
- Repeat for all other device types that are connected to the MPS-200.
- Press the **MENU** button to return to the menu.

NOTE: For information on using the front panel and input devices with the MPS-200, refer to “Operation” on page 74.

NOTE: If a C2N-MNETGW has been identified, infiNET switches and dimmers must still be identified with Crestron Toolbox. Refer to the respective infiNET switch and dimmer manuals for more information.

Upgrade Connected APADs

APAD devices may need to be programmed to work with the MPS-200. If a connected APAD does not display controls for the MPS-200, perform the following.

- Access the Control Setup menu as described on page 64.
- Press the ▲ or ▼ buttons until “APAD Upgrade” is displayed on the LCD and press **ENTER** to display the APAD Upgrade controls.

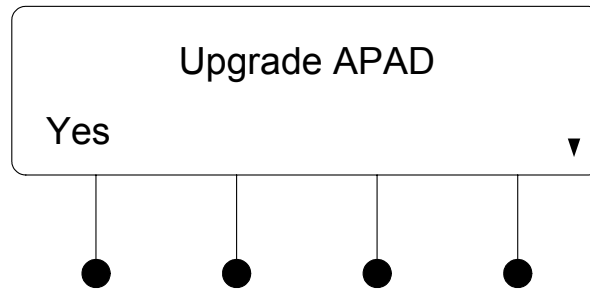
Display the APAD Upgrade Controls

- To upgrade the APAD, press the ▲ or ▼ buttons until “Yes” is displayed on the LCD and press **ENTER**. The MPS-200 will upgrade the APAD’s firmware (if necessary) and copy the required files to the APAD.
- To cancel the upgrade procedure without starting the upgrade process, press the ▲ or ▼ buttons until “No” is displayed on the LCD and press **ENTER**. Alternatively, you can press **MENU** to return to the Control Setup menu.

Change the Front Panel Password

The front panel password can be changed from the front panel:

- Access the Control Setup menu as described on page 64.
- Press the ▲ or ▼ buttons until “Password” is displayed on the LCD and press **ENTER** to display the Change Password controls.

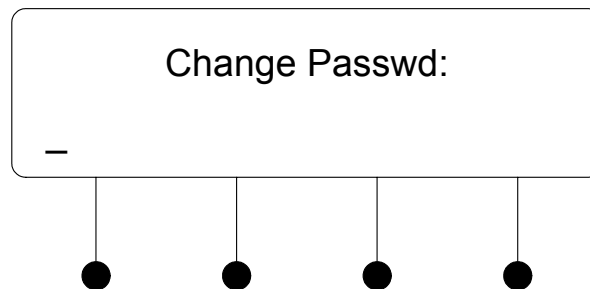
Display the Change Password Controls

- Turn the volume control to select the first digit in the password.
- Press the ▲ button to move the cursor to the next digit and select the next digit in the password with the volume control. The maximum password length is 20 digits. Press the ▼ button to move to the previous digit.
- To save the new password and return to the Control Setup menu, press **ENTER**.
- To cancel the process without saving any changes, press **MENU**. The display will return to the Control Setup menu.

View System Information

Use the front panel to view information about the MPS-200. Information that can be viewed includes program information, hardware information, network information, and operating system information.

NOTE: This information can be viewed using Crestron Toolbox. For more information, refer to the Crestron Toolbox help file.

- Access the Control Setup menu as described on page 64.
- Press the ▲ or ▼ buttons until “Info” is displayed on the LCD and press **ENTER** to display the Info menu.

Display the Info Menu

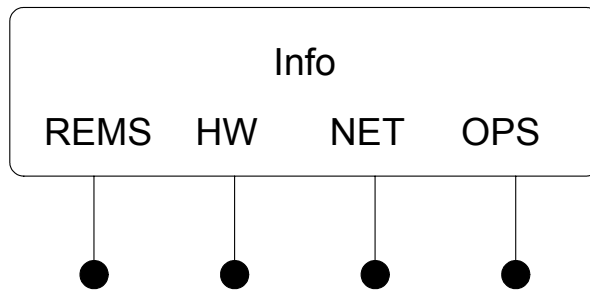

- To view program information, press the soft button labeled **REMS**.

Display the Program Information

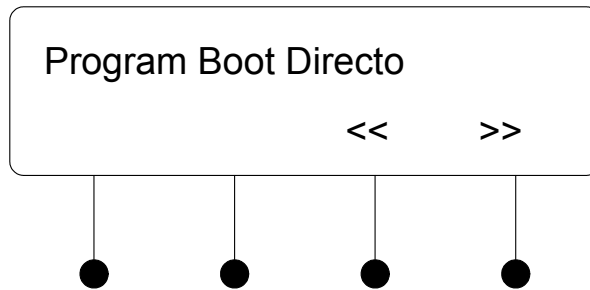

⇒ Press the ▲ or ▼ buttons to see other information. If partial information is displayed, press the soft buttons labeled << or >> to view the rest of the information.

⇒ Press the **MENU** button to return to the Info menu.

- To view hardware information, press the soft button labeled **HW**.

Display the Hardware Information

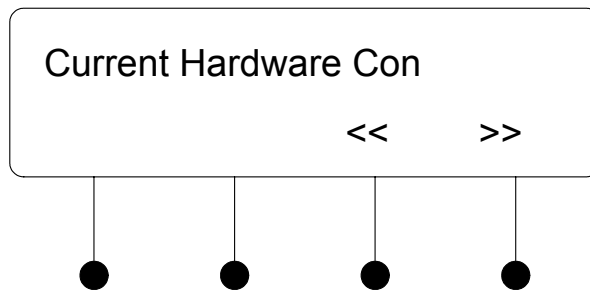

⇒ Press the ▲ or ▼ buttons to see other information. If partial information is displayed, press the soft buttons labeled << or >> to view the rest of the information.

⇒ Press the **MENU** button to return to the Info menu.

- To view a list of connected network devices, press the soft button labeled **NET**.

Display Connected Network Devices

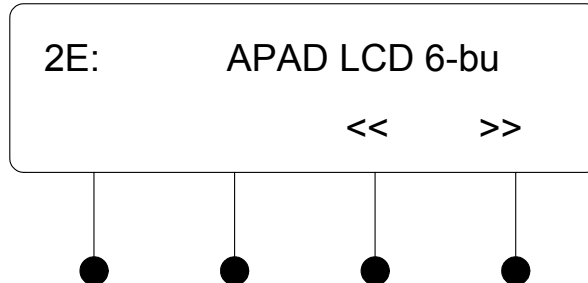

⇒ Press the ▲ or ▼ buttons to see other network devices. If the information for a network device is partially displayed, press the soft buttons labeled << or >> to view the rest of the information.

⇒ Press the **MENU** button to return to the Info menu.

- To view information on the MPS-200 operating system, press the soft button labeled **OPS**.

Display Operating System Information

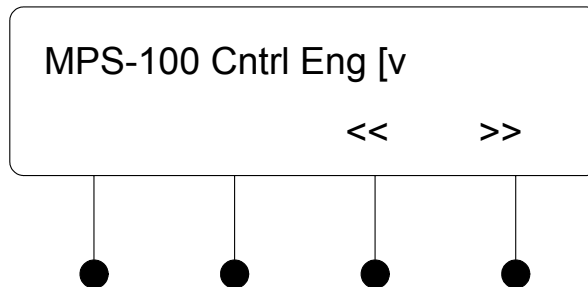

⇒ Press the soft buttons labeled << or >> to view the information that cannot fit on the display.

⇒ Press the **MENU** button to return to the Info menu.

- To return to the Control Setup menu, press **MENU**.

Review System Messages

The MPS-200 stores system messages in a message log. The presence of new messages in the log is indicated when the **MSG** LED is lit. To review system messages using the front panel:

- Access the Control Setup menu as described on page 64.
- Press the ▲ or ▼ buttons until “Messages” is displayed on the LCD and press **ENTER** to display the Message controls.

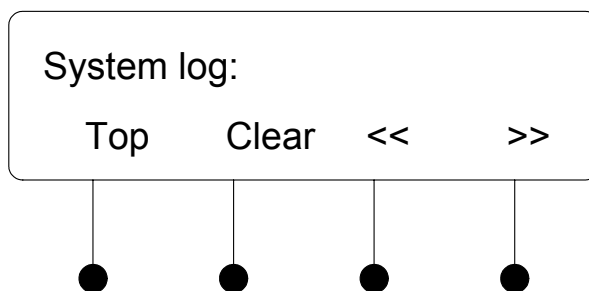
Display the Message Controls

- To scroll through messages in the log, press the ▲ or ▼ buttons.
- To jump to the beginning of the log, press the soft button labeled **Top**.
- To jump to the last message in the long, press the soft button labeled **Btm** (not shown).
- To view the contents of a message press the soft buttons labeled << or >>.
- To erase the contents of the log, press the soft button labeled **Clear**.
- Press **MENU** to return to the Control Setup menu.

NOTE: The contents of the message log can be read and saved using Crestron Toolbox. For more information, refer to the Crestron Toolbox help file.

Set the Date and Time

Use the front panel to set the MPS-200's date and time.

- Access the Control Setup menu as described on page 64.
- Press the ▲ or ▼ buttons until "Time/Date" is displayed on the LCD and press **ENTER** to display the Time/Date controls.

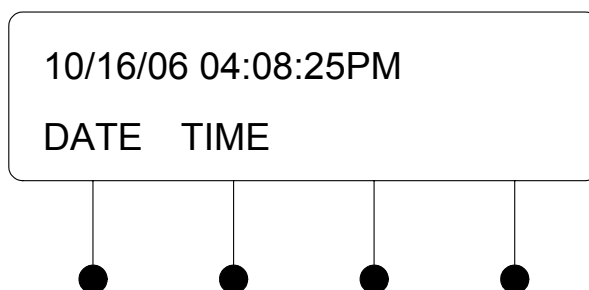
Display the Time/Date Controls

- To set the date, press the soft button labeled **DATE**. The Date controls will be displayed.

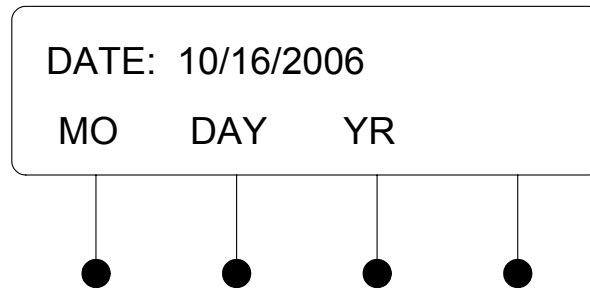
Display the Date Controls

- ⇒ To set the month, press the soft button labeled **MO**. To set the day, press the soft button labeled **DAY**. To set the year, press the soft button labeled **YR**. A pair of brackets will appear around the selected part of the date.
- ⇒ Press the ▲ or ▼ buttons to increase or decrease the value of the selected part of the date.
- ⇒ Repeat for each part of the date.
- ⇒ Press **ENTER** to store the new date and return to the Time/Date controls or press **MENU** to return to the Time/Date controls without saving any changes.
- To set the time, press the soft button labeled **TIME**.

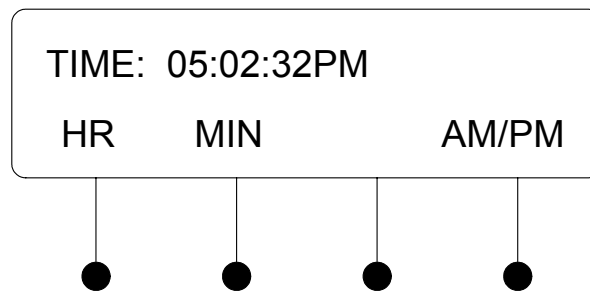
Display the Time Controls

- ⇒ To set the hour, press the soft button labeled **HR**. To set the minute, press the soft button labeled **MIN**. To set AM or PM, press the soft button labeled **AM/PM**. A pair of brackets will appear around the selected part of the time.
- ⇒ Press the ▲ or ▼ buttons to increase or decrease the value of the selected part of the time.
- ⇒ Repeat for each part of the time.
- ⇒ Press **ENTER** to store the new time and return to the Time/Date controls or press **MENU** to return to the Time/Date controls without saving any changes.
- To return to the Control Setup menu, press **MENU**.

NOTE: The date and time can be set using Crestron Toolbox. For more information, refer to the Crestron Toolbox help file.

Restore Default Settings

The MPS-200 can be restored to its default factory settings from the front panel. Users can select to restore the audio settings or to restore the audio settings, source names, output names, and function names.

- To restore audio settings only:
 - ⇒ Access the Control Setup menu as described on page 64.
 - ⇒ Press the ▲ or ▼ buttons until “Defaults” is displayed on the LCD and press **ENTER** to display the Restore Defaults menu.

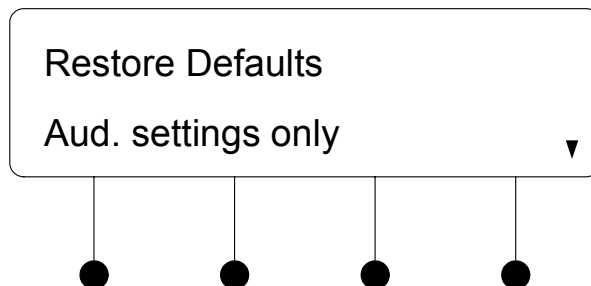
Restore Defaults Menu-Audio Settings Only

- ⇒ Press the ▲ or ▼ buttons until “Aud. settings only” is displayed on the LCD and press **ENTER**.

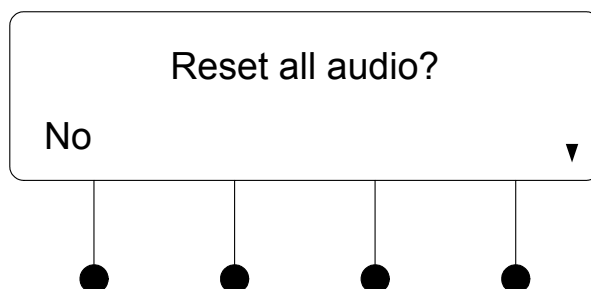
Confirm Restore Audio Default Settings Only

- ⇒ Press the ▲ or ▼ buttons until “Yes” is displayed on the LCD and press **ENTER** to restore the audio settings to the factory defaults. To cancel, press the ▲ or ▼ buttons until “No” is displayed on the LCD and press **ENTER**.
- To restore all factory default settings:
 - ⇒ Access the Control Setup menu as described on page 64.
 - ⇒ Press the ▲ or ▼ buttons until “Defaults” is displayed on the LCD and press **ENTER** to display the Restore Defaults menu.

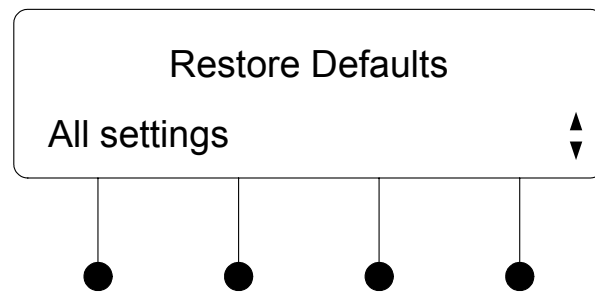
Restore Defaults Menu-All Settings

⇒ Press the ▲ or ▼ buttons until “All settings” is displayed on the LCD and press **ENTER**.

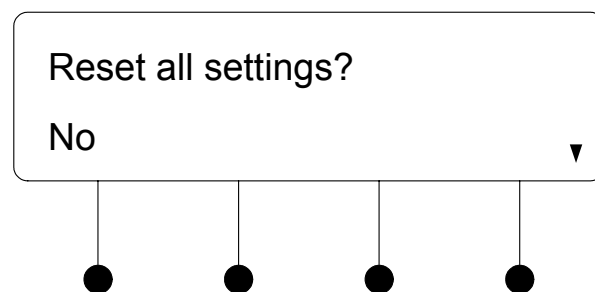
Confirm Restore All Default Settings Only

⇒ Press the ▲ or ▼ buttons until “Yes” is displayed on the LCD and press **ENTER** to restore the audio settings, source names, output names, and function names to the factory defaults. To cancel, press the ▲ or ▼ buttons until “No” is displayed on the LCD and press **ENTER**.

- To cancel:

⇒ Press the ▲ or ▼ buttons until “Abort” is displayed on the LCD and press **ENTER**. The restore operation will be cancelled.

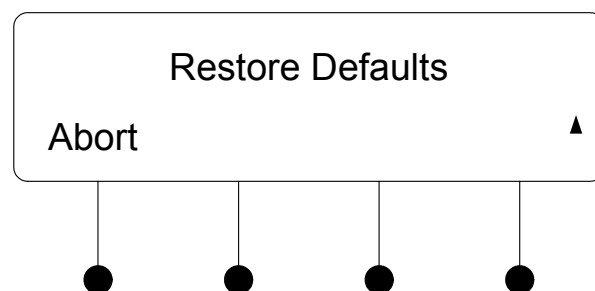
Cancel Restore Operation**Front Panel Lock Control**

The MPS-200’s front panel controls can be locked to prevent operational changes from the buttons on the front of the MPS-200. While locked, the menu can be accessed by pressing the **MENU** button. To open the Front Panel Lock control:

- Access the Control Setup menu as described on page 64.

- Press the ▲ or ▼ buttons until “Front Panel” is displayed on the LCD and press **ENTER** to display the Front Panel control.

Front Panel Lock Controls

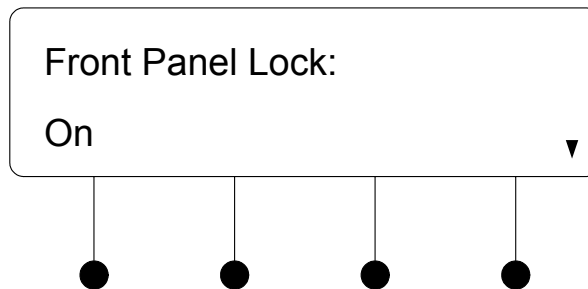

- Press the ▲ or ▼ buttons to toggle between On and Off. The current setting is indicated with an asterisk (*).
- Press **ENTER** to save the new setting and return to the Control Setup menu.

Operation

Using the out-of-the-box functionality, the MPS-200 can be operated from the front panel, an APAD, a 12-button keypad such as the CNX-B12 or the C2N-DB12, or the C2N-FTB FlipTop Control Center.

Control from the Front Panel

The following describes operation of a system when using the out-of-the-box functionality and the front panel. If a custom program has been created, the system may function differently.

Turn On the System

To turn on the system:

1. Select an output by pressing either of the output buttons (**PROJ** or **TOUCH PANEL**). Pressing the button labeled **PROJ** will route the video signal to a projector. Pressing the button labeled **TOUCH PANEL** will route the video signal to a Crestron touchpanel.
2. Select any of the source inputs by pressing an input button (**BNC 1**, **BNC 2**, **BNC 3**, **BNC 4**, **RGBHV 5**, **RGBHV 6**, **RGBHV 7**, or **RGBHV 8**).

NOTE: If the projector output was selected (by pressing **PROJ**), the display will prompt the user to turn on the projector.

Turn Off the System

To turn off the system, press the **SYS PWR** button twice.

NOTE: If the projector output was selected (output button 1), the display will prompt the user to turn off the projector.

Lower the Projection Screen

Press the function button labeled **SCREEN DOWN** to lower the projector screen.

NOTE: This function will only work if a projection screen's control lines have been connected to **RELAY 1** (up control) and **RELAY 2** (down control).

Raise the Projection Screen

Press the button labeled **SCREEN UP** to raise the projector screen.

NOTE: This function will only work if a projection screen's control lines have been connected to **RELAY 1** (up control) and **RELAY 2** (down control).

Adjust the Volume Level

The volume control of the MPS-200 consists of three parts; a program volume control, a speech volume control, and a master volume control. The program and speech volumes can be controlled independently of each other or can be jointly controlled from the master volume control as shown in the following diagram.

MPS-200 Volume Control System

PROGRAM volume is set to Program Start volume when **SYS PWR** is pressed.

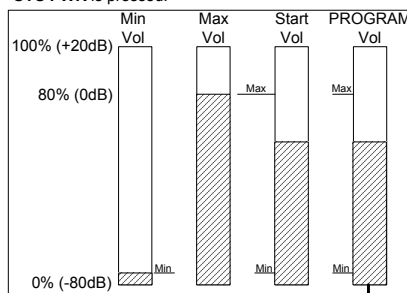

SPEECH volume is set to Speech Start volume when **SYS PWR** is pressed.

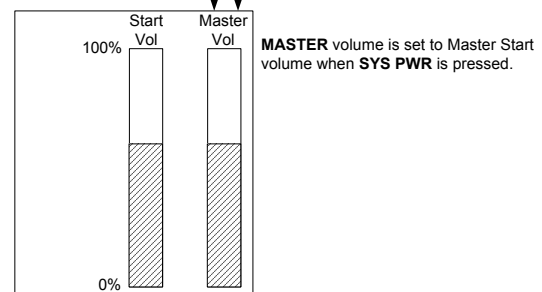
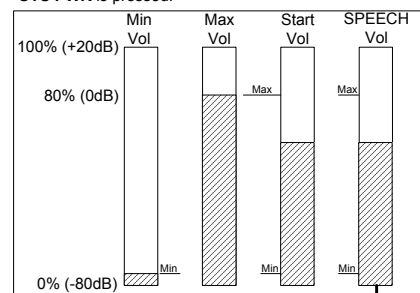

The volume level of the MPS-200 is adjusted with the volume control knob. The volume control knob will only control the volume parameter that was selected when the Volume Control Mode was specified as described on 45.

NOTE: If the volume control mode is set to the user-selectable mode, press the soft button labeled "PGM VOL" to control the **PROGRAM** output volume or the soft button labeled "SPCH VOL" to control the **SPEECH** output volume.

- **Raise the volume:** Turn the volume control clockwise. The volume level will be displayed on the LCD.

- **Lower the volume:** Turn the volume control counterclockwise. The volume level will be displayed on the LCD.

Mute Audio

The audio output of the MPS-200 can be muted with the **MUTE** button.

- **Mute the audio output:** Press the button labeled **MUTE**.
- **Unmute the audio output:** Press the **MUTE** button again.

Adjust Lighting

To set lighting to one of two preset lighting values, press either **LIGHTS PRE 1** or **LIGHTS PRE 2**.

NOTE: This function will only work if a CLS-C6, infiNET switch, or infiNET dimmer was previously identified and connected to the MPS-200. The CLS-C6 can be identified as a Cresnet device in the MPS-200 setup screens as described on page 65. Crestron's infiNET switches and dimmers require a C2N-MNETGW to be identified as described on page 65 in addition to identifying the individual switch and/or dimmer with a unique identity code (MNET ID) using Crestron Toolbox. CLW-DIM1RF and CLW-DIMS1RF dimmers use MNET IDs 03 and 04 while CLW-SW1RF and CLW-SWS1RF switches use MNET IDs 05 and 06. For information on identifying infiNET switches and dimmers, refer to the Crestron Toolbox help file.

Control from an APAD

The following describes operation of the system when using the out-of-the-box functionality and an APAD Wall Mount LCD Controller. If a custom program has been created, the system may function differently.

The APAD has six buttons and a Nav Wheel as shown in the following diagram.

APAD Buttons

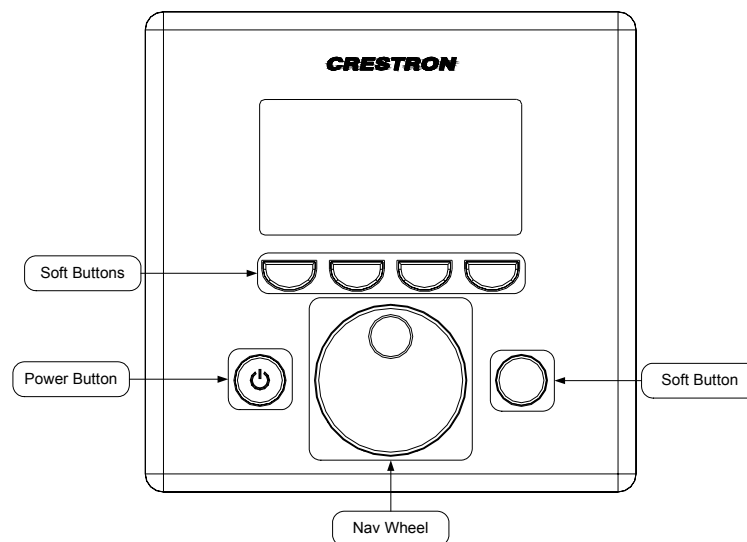

When switching sources from the APAD, the MPS-200 will route the signal to the projector output and then route the signal to the touchpanel output.

Turn On the System

To turn on the system:

1. Press the soft button labeled **Source** to display a list of available sources.
2. Turn the Nav Wheel to highlight the desired source (**BNC 1**, **BNC 2**, **BNC 3**, **BNC 4**, **RGBHV 5**, **RGBHV 6**, **RGBHV 7**, or **RGBHV 8**).

NOTE: Typically, signal routing information is not displayed on the front panel of the MPS-200. However, if an output button on the MPS-200 was pressed at any point during operation, routing information will be displayed and updated should any changes to routing be made.

3. Press the soft button labeled **Select** to route the source to the projector and touchpanel output.

Turn Off the System

To turn off the system:

1. Press the **Power** button.
2. Press the soft button labeled **Sys. Off**.
3. Press the soft button labeled **Yes** to confirm. The display will indicate that the system is turning off.

Raise or Lower the Projection Screen

To raise or lower the projection screen:

1. Press the soft button labeled **Environ**.
2. Press the soft button labeled **Screen**.
3. To raise the projection screen, press the soft button labeled **Up**. To lower the projection screen, press the soft button labeled **Down**. The display will indicate the status of the projection screen. The front panel of the MPS-200 will indicate the screen's status.

NOTE: This function will only work if a projection screen's control lines have been connected to **RELAY 1** (up control) and **RELAY 2** (down control).

Adjust the Volume Level

The volume level of the MPS-200 is adjusted with the Nav wheel.

The volume controlled by the APAD is determined by the volume control mode setting. If the volume control mode was set to **MASTER VOLUME**, then the APAD will control the master volume. Otherwise, the APAD will control the program volume only. For more information on the volume control mode, refer to page 45.

- **Raise the volume:** Turn the Nav wheel clockwise. The volume level will be displayed on the LCD.
- **Lower the volume:** Turn the Nav wheel counterclockwise. The volume level will be displayed on the LCD.

Mute Audio

The audio output of the MPS-200 can be muted with the APAD.

- **To Mute the audio output:**
 - ⇒ Press the power button
 - ⇒ Press the soft button labeled **Mute**. The display will indicate that the audio output is muted. The front panel of the MPS-200 will indicate the status of the mute function.
- **To Unmute the audio output:**
 - ⇒ Press the soft button labeled **Unmute**.

Adjust Lighting

To set lighting to one of two preset lighting values:

1. Press the soft button labeled **Environ**.
2. Press the soft button labeled **Lights**.
3. Turn the Nav wheel to highlight the desired lighting preset and press the soft button labeled **Select**. The front panel of the MPS-200 will indicate the selected preset light setting.
4. Press the soft button labeled **Back** to return to the lighting controls.

NOTE: This function will only work if a CLS-C6, infiNET switch, or infiNET dimmer was previously identified and connected to the MPS-200. The CLS-C6 can be identified as a Cresnet device in the MPS-200 setup screens as described on page 65. Crestron's infiNET switches and dimmers require a C2N-MNETGW to be identified as described on page 65 in addition to identifying the individual switch and/or dimmer with a unique identity code (MNET ID) using Crestron Toolbox. CLW-DIM1RF and CLW-DIMS1RF dimmers use MNET IDs 03 and 04 while CLW-SW1RF and CLW-SWS1RF switches use MNET IDs 05 and 06. For information on identifying infiNET switches and dimmers, refer to the Crestron Toolbox help file.

Raise or Lower Drapes

To raise or lower the drapes:

1. Press the soft button labeled **Environ**.
2. Press the soft button labeled **Drapes**.
3. To raise the drapes, press the soft button labeled **Up**. To lower the drapes, press the soft button labeled **Down**. The display will indicate the status of the drapes.

NOTE: This function will only work if a drape controller has been configured in Crestron SystemBuilder or SIMPL Windows and connected to the MPS-200.

Control from a Keypad

The following describes operation of the system when using the out-of-the-box functionality and either a C2N-DB12 or CNX-B12 keypad. If a custom program has been created, the MPS-200 may function differently.

NOTE: Buttons for the keypad are custom engraved using Crestron SystemBuilder software. For instructions on installing the buttons on the keypad, refer to the keypad's guide.

The keypad has twelve buttons as shown in the following diagram.

C2N-DB12 Buttons

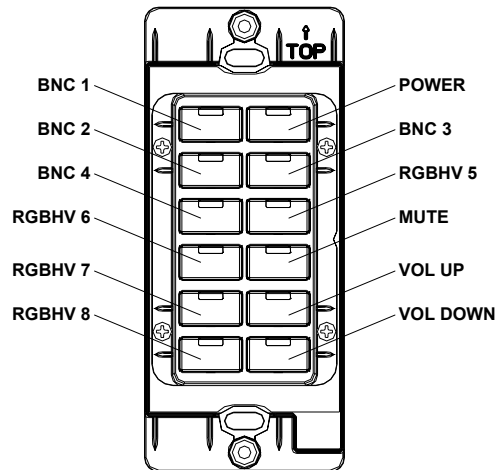

NOTE: Custom buttons can be created using Crestron Engraver software. For instructions on installing the custom buttons, refer to the keypad guide.

When switching sources from the keypad, the MPS-200 will route the signal to the projector output and then route the signal to the touchpanel output.

Turn On the System

To turn on the system, press any of the source buttons on the left-side of the button pad.

NOTE: Typically, signal routing information is not displayed on the front panel of the MPS-200. However, if an output button on the MPS-200 was pressed at any point during operation, routing information will be displayed and updated should any changes to routing be made.

Turn Off the System

To turn off the system, press the **POWER** button.

Adjust the Volume Level

To raise the volume level, press the **VOL UP** button. To lower the volume, press the **VOL DOWN** button. The volume buttons will only control the volume parameter that was selected when the Volume Control Mode was specified as described on page 45.

Mute Audio

To mute the audio output, press the **MUTE** button. To unmute, press the **MUTE** button again. The front panel of the MPS-200 will indicate the status of the mute function.

Control from a C2N-FTB

The following describes operation of the system when using the out-of-the-box functionality and a C2N-FTB FlipTop Control Center. If a custom program has been created, the MPS-200 may function differently.

NOTE: Buttons for the keypad are custom engraved using Crestron SystemBuilder software. For instructions on installing the buttons on the control center, refer to the control center's guide.

The control center has 10 buttons as shown in the following diagram.

C2N-FTB Buttons

Button 1: Power
 Button 2: BNC 1
 Button 3: BNC 3
 Button 4: RGBHV 5
 Button 5: RGBHV 7
 Button 6: BNC 2
 Button 7: BNC 4
 Button 8: RGBHV 6
 Button 9: RGBHV 8
 Button 10: Lights Pre 1
 Button 11: Lights Pre 2
 Button 12: Screen
 Button 13: Mute
 Button 14: Volume Up
 Button 15: Volume Down

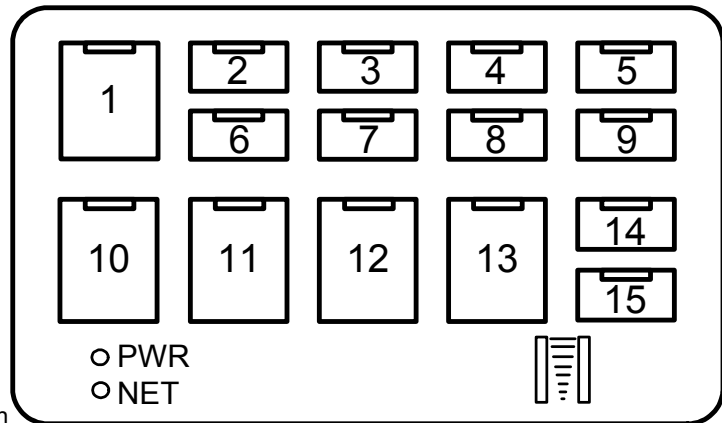

NOTE: Custom buttons can be created using Crestron Engraver software. For instructions on installing the custom buttons, refer to the C2N-FTB guide.

When switching sources from the C2N-FTB, the MPS-200 will route the signal to the projector output and then route the signal to the touchpanel output.

Turn On the System

To turn on the system, press any of the source buttons on the control center.

NOTE: Typically, signal routing information is not displayed on the front panel of the MPS-200. However, if an output button on the MPS-200 was pressed at any point during operation, routing information will be displayed and updated should any changes to routing be made.

Turn Off the MPS-200

To turn off the system, press the **POWER** button.

Raise or Lower the Projection Screen

To raise or lower the projection screen, press the **SCREEN** button. The front panel of the MPS-200 will also indicate the screen's status.

NOTE: This function will only work if a projection screen's control lines have been connected to **RELAY 1** (up control) and **RELAY 2** (down control).

Adjust the Volume Level

To raise the volume level, press the **VOL UP** button. To lower the volume, press the **VOL DOWN** button. The volume control buttons will only control the volume parameter that was selected when the Volume Control Mode was specified as described on page 45.

Mute Audio

To mute the audio output, press the **MUTE** button. To unmute, press the **MUTE** button again. The front panel of the MPS-200 will indicate the status of the mute function.

Adjust Lighting

To toggle between preset light settings, press either of the **LIGHTS** buttons. The front panel of the MPS-200 will indicate the selected preset light setting.

NOTE: This function will only work if a CLS-C6, infiNET switch, or infiNET dimmer was previously identified and connected to the MPS-200. The CLS-C6 can be identified as a Cresnet device in the MPS-200 setup screens as described on page 65. Crestron's infiNET switches and dimmers require a C2N-MNETGW to be identified as described on page 65 in addition to identifying the individual switch and/or dimmer with a unique identity code (MNET ID) using Crestron Toolbox. CLW-DIM1RF and CLW-DIMS1RF dimmers use MNET IDs 03 and 04 while CLW-SW1RF and CLW-SWS1RF switches use MNET IDs 05 and 06. For information on identifying infiNET switches and dimmers, refer to the Crestron Toolbox help file.

Problem Solving

Troubleshooting

The following table provides corrective action for possible trouble situations. If further assistance is required, please contact a Crestron customer service representative.

MPS-200 Troubleshooting

TROUBLE	POSSIBLE CAUSE(S)	CORRECTIVE ACTION
Unexpected response from control system.	Network devices are not communicating with the control system.	Use Crestron Toolbox to poll the network. Verify network connection to the device.
PWR LED does not illuminate.	Control system is not receiving power.	Verify the power cord is properly attached to the control system and securely plugged into an outlet.
MSG LED illuminates.	Hardware or software failure, hardware incompatibility with software definitions or programming error.	Verify that hardware configuration matches software configuration. Use Crestron Toolbox to display the error log. Refer to "Error Message Definitions" in the latest version of the Crestron 2-Series Control Systems Reference Guide (Doc. 6256) for more details.
System locks up.	Various.	Press and release front panel HW-R button, then press and hold SW-R button to bypass program and communicate directly with the processor. (Refer to "Troubleshooting Communications" in the Crestron 2-Series Control Systems Reference Guide (Doc. 6256) for more details.
Cresnet device does not respond.	Device not wired correctly.	Verify Cresnet wiring.
	Improper NET ID used.	Verify that device ID matches NET ID in the program.
A/V system device does not respond.	Device is not receiving sufficient power.	User the Crestron Power Calculator to help calculate how much power is needed for the system.
Poor picture quality (RGB).	Cables improperly connected.	Verify that all cables are secure.
	Display device not configured properly.	Configure display device to match output frequency.
	Incorrect sync input impedance.	Set DIP switches to lower sync input impedance.
Poor picture quality (Video).	Cables improperly connected.	Verify that all cables are secure.

NOTE: If communication cannot be established or the control system is locked-up, refer to “Troubleshooting Communications” in the Crestron 2-Series Control Systems Reference Guide (Doc. 6256).

NOTE: *Passthrough Mode* enables Viewport access to any serial controlled device on the network. This aids in troubleshooting by allowing direct communication between the PC and a network device (effectively “passing through” the MPS-200). For information pertaining to Passthrough Mode, refer to “Passthrough Mode” in the Crestron 2-Series Control Systems Reference Guide (Doc. 6256).

System Monitor

The System Monitor allows you to reload firmware into the MPS-200 in the event that you cannot load the firmware in the normal mode.

If the system does not function, perform the following procedure:

1. Disconnect all Crestron USB devices from the PC.
2. On the MPS-200, press and release the **HW-R** button. The **MSG** LED will start blinking rapidly four times per second.
3. During the rapid blink of the **MSG** LED, press and release the **SW-R** button. This will put the MPS-200 into “Wait” mode for the next five seconds. During this mode the **MSG** LED will blink slowly, once per second.
4. During “Wait” mode, press and release the **SW-R** button again. The MPS-200 will now enter the “Wait Acknowledge” mode for the next five seconds. During this mode the **MSG** LED will blink rapidly four times per second.
5. During “Wait Acknowledge” mode, press and release the **SW-R** button a third time. The MPS-200 will enter “Monitor” mode. Once the MPS-200 is in “Monitor” mode, the **MSG** LED will flash to indicate “Monitor” mode. The display will also indicate the “Monitor” mode.
6. Once the MPS-200 is in “Monitor” mode, connect to the PC using a USB cable.

NOTE: If at any point in the above sequence, one of the timer periods expires without the **SW-R** button being pressed, the unit will boot normally, first running the firmware, then loading the application.

NOTE: If your PC does not have the USB driver installed, after connecting the MPS-200 to the PC using the USB cable, you will see a dialog box on your PC screen asking you to install the USB driver. For instructions on how to install the USB driver, refer to the Crestron Toolbox help file.

7. Open Toolbox and start the Text Console (click the  icon). Then, click on the Address Book icon in the lower left corner of the window to open the “Address Book” window.
8. In the “Address Book” window, click the “Add Entry” button and give the new entry a name (e.g. “System Monitor”).
9. Click the arrow next to the “Device Type” drop down list. A “Warning” window will open to inform you that this is an advanced feature. Click **OK**, then select “2-Series Control System Monitor” from the drop down list.

Make sure to choose **USB** as the “Connection Type”, then click **OK**. The following text will appear in the bottom right corner of the “Text Console” window:

```
usb;device 2SeriesCtrlSystemMonitor
```

The following text will appear in Toolbox:

```
MPSMNTR>
```

- At the Toolbox prompt, type **erase** and press **Enter**. The following text will appear in Toolbox:

```
Erasing
```

```
->25%->50%->75%->100%
```

```
Done
```

- Click the  icon and select **Firmware...** to open the “Firmware” window, then click **Browse**.
- Find and select the correct firmware file (.CUZ or .zip) and click **Open**.
- In the “Firmware” window, click **Send**. You will see a “Confirmation” window asking if you’ve selected the right file. Click **OK** and you will see the “File Transfer” window.
- When file transfer is completed, you will see a window asking you to re-connect. Click **OK**, then close the “Firmware” window and re-connect using the normal Address Book entry.

Network Analysis

To assist with troubleshooting, you can use Crestron’s C2N-ANLZ Cresnet Analyzer (sold separately) to monitor the integrity of the Cresnet network for wiring faults and marginal system performance or other network errors. For more information on how to use the C2N-ANLZ, refer to the C2N-ANLZ Operations Guide (Doc. 6473).

Battery Replacement

A Lithium battery is used to power the system clock within the MPS-200. Under normal conditions, it will last for approximately 10 years. In the event that the clock fails, only an authorized technician should replace it. Refer to caution statement below.

CAUTION: Danger of explosion if battery is incorrectly replaced. Replace only with the same or equivalent type recommended by the manufacturer. Dispose of used batteries according to the manufacturer's instructions.

Check Network Wiring

Use the Right Wire

In order to ensure optimum performance over the full range of your installation topology, Crestron Certified Wire and only Crestron Certified Wire may be used. Failure to do so may incur additional charges if support is required to identify performance deficiencies because of using improper wire.

Calculate Power

CAUTION: Use only Crestron power supplies for Crestron equipment. Failure to do so could cause equipment damage or void the Crestron warranty.

CAUTION: Provide sufficient power to the system. Insufficient power can lead to unpredictable results or damage to the equipment. Please use the Crestron Power Calculator to help calculate how much power is needed for the system (<http://www.crestron.com/calculators>).

When calculating the length of wire for a particular Cresnet run, the wire gauge and the Cresnet power usage of each network unit to be connected must be taken into consideration. Use Crestron Certified Wire only. If Cresnet units are to be daisy-chained on the run, the Cresnet power usage of each network unit to be daisy-chained must be added together to determine the Cresnet power usage of the entire chain. If the unit is home-run from a Crestron system power supply network port, the Cresnet power usage of that unit is the Cresnet power usage of the entire run. The wire gauge and the Cresnet power usage of the run should be used in the following equation to calculate the cable length value on the equation's left side.

Cable Length Equation

$$L < \frac{40,000}{R \times P}$$

Where: L = Length of run (or chain) in feet
 R = 6 Ohms (Crestron Certified Wire: 18 AWG (0.75 MM²))
 or 1.6 Ohms (Cresnet HP: 12 AWG (4 MM²))
 P = Cresnet power usage of entire run (or chain)

Make sure the cable length value is less than the value calculated on the right side of the equation. For example, a Cresnet run using 18 AWG Crestron Certified Wire and drawing 20 watts should not have a length of run more than 333 feet. If Cresnet HP is used for the same run, its length could extend to 1250 feet.

NOTE: All Crestron certified Cresnet wiring must consist of two twisted pairs. One twisted pair is the +24V conductor and the GND conductor and the other twisted pair is the Y conductor and the Z conductor.

Strip and Tin Wire

When daisy-chaining Cresnet units, strip the ends of the wires carefully to avoid nicking the conductors. Twist together the ends of the wires that share a pin on the network connector and tin the twisted connection. Apply solder only to the ends of the twisted wires. Avoid tinning too far up the wires or the end becomes brittle. Insert the tinned connection into the Cresnet connector and tighten the retaining screw. Repeat the procedure for the other three conductors.

Add Hubs

For larger networks (i.e., greater than 28 network devices), it may become necessary to add a Cresnet Hub/Repeater (CNXHUB) to maintain signal quality throughout the network. Also, for networks with lengthy cable runs it may be necessary to add a Hub/Repeater after only 20 devices.

Reference Documents

The latest version of all documents mentioned within the guide can be obtained from the Crestron website (<http://www.crestron.com/manuals>). This link will provide a list of product manuals arranged in alphabetical order by model number.

List of Related Reference Documents

DOCUMENT TITLE
2-Series Control Systems Reference Guide
APAD Wall Mount LCD Controller
C2N-ANLZ Cresnet Analyzer
C2N-DB12 12-Button Decorator Function Keypads
CNX-B12 12-Button Designer Keypads
C2N-FTB FlipTop Control Center
C2N-MNETGW infiNET Gateway/Transceiver
CAT5 Wiring Reference Guide
CLS-C6 iLux Integrated Lighting System
Crestron e-Control Reference Guide
QM-AMP Three Channel Amplifier
MediaManager Applications Guide

Further Inquiries

If you cannot locate specific information or have questions after reviewing this guide, please take advantage of Crestron's award winning customer service team by calling the Crestron corporate headquarters at 1-888-CRESTRON [1-888-273-7876]. For assistance in your local time zone, refer to the Crestron website (<http://www.crestron.com/offices>) for a listing of Crestron worldwide offices.

You can also log onto the online help section of the Crestron website (<http://www.crestron.com/onlinehelp>) to ask questions about Crestron products. First-time users will need to establish a user account to fully benefit from all available features.

Future Updates

As Crestron improves functions, adds new features and extends the capabilities of the MPS-200, additional information may be made available as manual updates. These updates are solely electronic and serve as intermediary supplements prior to the release of a complete technical documentation revision.

Check the Crestron website periodically for manual update availability and its relevance. Updates are identified as an “Addendum” in the Download column.

Software License Agreement

This License Agreement (“Agreement”) is a legal contract between you (either an individual or a single business entity) and Crestron Electronics, Inc. (“Crestron”) for software referenced in this guide, which includes computer software and as applicable, associated media, printed materials and “online” or electronic documentation (the “Software”).

BY INSTALLING, COPYING OR OTHERWISE USING THE SOFTWARE, YOU REPRESENT THAT YOU ARE AN AUTHORIZED DEALER OF CRESTRON PRODUCTS OR A CRESTRON AUTHORIZED INDEPENDENT PROGRAMMER AND YOU AGREE TO BE BOUND BY THE TERMS OF THIS AGREEMENT. IF YOU DO NOT AGREE TO THE TERMS OF THIS AGREEMENT, DO NOT INSTALL OR USE THE SOFTWARE.

IF YOU HAVE PAID A FEE FOR THIS LICENSE AND DO NOT ACCEPT THE TERMS OF THIS AGREEMENT, CRESTRON WILL REFUND THE FEE TO YOU PROVIDED YOU (1) CLICK THE DO NOT ACCEPT BUTTON, (2) DO NOT INSTALL THE SOFTWARE AND (3) RETURN ALL SOFTWARE, MEDIA AND OTHER DOCUMENTATION AND MATERIALS PROVIDED WITH THE SOFTWARE TO CRESTRON AT: CRESTRON ELECTRONICS, INC., 15 VOLVO DRIVE, ROCKLEIGH, NEW JERSEY 07647, WITHIN 30 DAYS OF PAYMENT.

LICENSE TERMS

Crestron hereby grants You and You accept a nonexclusive, nontransferable license to use the Software (a) in machine readable object code together with the related explanatory written materials provided by Crestron (b) on a central processing unit (“CPU”) owned or leased or otherwise controlled exclusively by You and (c) only as authorized in this Agreement and the related explanatory files and written materials provided by Crestron.

If this software requires payment for a license, you may make one backup copy of the Software, provided Your backup copy is not installed or used on any CPU. You may not transfer the rights of this Agreement to a backup copy unless the installed copy of the Software is destroyed or otherwise inoperable and You transfer all rights in the Software.

You may not transfer the license granted pursuant to this Agreement or assign this Agreement without the express written consent of Crestron.

If this software requires payment for a license, the total number of CPU’s on which all versions of the Software are installed may not exceed one per license fee (1) and no concurrent, server or network use of the Software (including any permitted back-up copies) is permitted, including but not limited to using the Software (a) either directly or through commands, data or instructions from or to another computer (b) for local, campus or wide area network, internet or web hosting services or (c) pursuant to any rental, sharing or “service bureau” arrangement.

The Software is designed as a software development and customization tool. As such Crestron cannot and does not guarantee any results of use of the Software or that the Software will operate error free and You acknowledge that any development that You perform using the Software or Host Application is done entirely at Your own risk.

The Software is licensed and not sold. Crestron retains ownership of the Software and all copies of the Software and reserves all rights not expressly granted in writing.

OTHER LIMITATIONS

You must be an Authorized Dealer of Crestron products or a Crestron Authorized Independent Programmer to install or use the Software. If Your status as a Crestron Authorized Dealer or Crestron Authorized Independent Programmer is terminated, Your license is also terminated.

You may not rent, lease, lend, sublicense, distribute or otherwise transfer or assign any interest in or to the Software.

You may not reverse engineer, decompile or disassemble the Software.

You agree that the Software will not be shipped, transferred or exported into any country or used in any manner prohibited by the United States Export Administration Act or any other export laws, restrictions or regulations (“Export Laws”). By downloading or installing the Software You (a) are certifying that You are not a national of Cuba, Iran, Iraq, Libya, North Korea, Sudan, Syria or any country to which the United States embargoes goods (b) are certifying that You are not otherwise prohibited from receiving the Software and (c) You agree to comply with the Export Laws.

If any part of this Agreement is found void and unenforceable, it will not affect the validity of the balance of the Agreement, which shall remain valid and enforceable according to its terms. This Agreement may only be modified by a writing signed by an authorized officer of Crestron. Updates may be licensed to You by Crestron with additional or different terms. This is the entire agreement between Crestron and You relating to the Software and it supersedes any prior representations, discussions, undertakings, communications or advertising relating to the Software. The failure of either party to enforce any right or take any action in the event of a breach hereunder shall constitute a waiver unless expressly acknowledged and set forth in writing by the party alleged to have provided such waiver.

If You are a business or organization, You agree that upon request from Crestron or its authorized agent, You will within thirty (30) days fully document and certify that use of any and all Software at the time of the request is in conformity with Your valid licenses from Crestron or its authorized agent.

Without prejudice to any other rights, Crestron may terminate this Agreement immediately upon notice if you fail to comply with the terms and conditions of this Agreement. In such event, you must destroy all copies of the Software and all of its component parts.

PROPRIETARY RIGHTS

Copyright. All title and copyrights in and to the Software (including, without limitation, any images, photographs, animations, video, audio, music, text and “applets” incorporated into the Software), the accompanying media and printed materials and any copies of the Software are owned by Crestron or its suppliers. The Software is protected by copyright laws and international treaty provisions. Therefore, you must treat the Software like any other copyrighted material, subject to the provisions of this Agreement.

Submissions. Should you decide to transmit to Crestron’s website by any means or by any media any materials or other information (including, without limitation, ideas, concepts or techniques for new or improved services and products), whether as information, feedback, data, questions, comments, suggestions or the like, you agree such submissions are unrestricted and shall be deemed non-confidential and you automatically grant Crestron and its assigns a non-exclusive, royalty-free, worldwide, perpetual, irrevocable license, with the right to sublicense, to use, copy, transmit, distribute, create derivative works of, display and perform the same.

Trademarks. CRESTRON and the Swirl Logo are registered trademarks of Crestron Electronics, Inc. You shall not remove or conceal any trademark or proprietary notice of Crestron from the Software including any back-up copy.

GOVERNING LAW

This Agreement shall be governed by the laws of the State of New Jersey, without regard to conflicts of laws principles. Any disputes between the parties to the Agreement shall be brought in the state courts in Bergen County, New Jersey or the federal courts located in the District of New Jersey. The United Nations Convention on Contracts for the International Sale of Goods shall not apply to this Agreement.

CRESTRON LIMITED WARRANTY

CRESTRON warrants that: (a) the Software will perform substantially in accordance with the published specifications for a period of ninety (90) days from the date of receipt and (b) that any hardware accompanying the Software will be subject to its own limited warranty as stated in its accompanying written material. Crestron shall, at its option, repair or replace or refund the license fee for any Software found defective by Crestron if notified by you within the warranty period. The foregoing remedy shall be your exclusive remedy for any claim or loss arising from the Software.

CRESTRON shall not be liable to honor warranty terms if the product has been used in any application other than that for which it was intended or if it as been subjected to misuse, accidental damage, modification or improper installation procedures. Furthermore, this warranty does not cover any product that has had the serial number or license code altered, defaced, improperly obtained or removed.

Notwithstanding any agreement to maintain or correct errors or defects, Crestron shall have no obligation to service or correct any error or defect that is not reproducible by Crestron or is deemed in Crestron’s reasonable discretion to have resulted from (1) accident; unusual stress; neglect; misuse; failure of electric power, operation of the Software with other media not meeting or not maintained in accordance with the manufacturer’s specifications or causes other than ordinary use; (2) improper installation by anyone other than Crestron or its authorized agents of the Software that deviates from any operating procedures established by Crestron in the material and files provided to You by Crestron or its authorized agent; (3) use of the Software on unauthorized hardware or (4) modification of, alteration of or additions to the Software undertaken by persons other than Crestron or Crestron’s authorized agents.

ANY LIABILITY OF CRESTRON FOR A DEFECTIVE COPY OF THE SOFTWARE WILL BE LIMITED EXCLUSIVELY TO REPAIR OR REPLACEMENT OF YOUR COPY OF THE SOFTWARE WITH ANOTHER COPY OR REFUND OF THE INITIAL LICENSE FEE CRESTRON RECEIVED FROM YOU FOR THE DEFECTIVE COPY OF THE PRODUCT. THIS WARRANTY SHALL BE THE SOLE AND EXCLUSIVE REMEDY TO YOU. IN NO EVENT SHALL CRESTRON BE LIABLE FOR INCIDENTAL, CONSEQUENTIAL, SPECIAL OR PUNITIVE DAMAGES OF ANY KIND (PROPERTY OR ECONOMIC DAMAGES INCLUSIVE), EVEN IF A CRESTRON REPRESENTATIVE HAS BEEN ADVISED OF THE POSSIBILITY OF SUCH DAMAGES OR OF ANY CLAIM BY ANY THIRD PARTY. CRESTRON MAKES NO WARRANTIES, EXPRESS OR IMPLIED, AS TO TITLE OR INFRINGEMENT OF THIRD-PARTY RIGHTS, MERCHANTABILITY OR FITNESS FOR ANY PARTICULAR PURPOSE, OR ANY OTHER WARRANTIES, NOR AUTHORIZES ANY OTHER PARTY TO OFFER ANY WARRANTIES, INCLUDING WARRANTIES OF MERCHANTABILITY FOR THIS PRODUCT. THIS WARRANTY STATEMENT SUPERSEDES ALL PREVIOUS WARRANTIES.

Return and Warranty Policies

Merchandise Returns / Repair Service

1. No merchandise may be returned for credit, exchange or service without prior authorization from CRESTRON. To obtain warranty service for CRESTRON products, contact an authorized CRESTRON dealer. Only authorized CRESTRON dealers may contact the factory and request an RMA (Return Merchandise Authorization) number. Enclose a note specifying the nature of the problem, name and phone number of contact person, RMA number and return address.
2. Products may be returned for credit, exchange or service with a CRESTRON Return Merchandise Authorization (RMA) number. Authorized returns must be shipped freight prepaid to CRESTRON, 6 Volvo Drive, Rockleigh, N.J. or its authorized subsidiaries, with RMA number clearly marked on the outside of all cartons. Shipments arriving freight collect or without an RMA number shall be subject to refusal. CRESTRON reserves the right in its sole and absolute discretion to charge a 15% restocking fee plus shipping costs on any products returned with an RMA.
3. Return freight charges following repair of items under warranty shall be paid by CRESTRON, shipping by standard ground carrier. In the event repairs are found to be non-warranty, return freight costs shall be paid by the purchaser.

CRESTRON Limited Warranty

CRESTRON ELECTRONICS, Inc. warrants its products to be free from manufacturing defects in materials and workmanship under normal use for a period of three (3) years from the date of purchase from CRESTRON, with the following exceptions: disk drives and any other moving or rotating mechanical parts, pan/tilt heads and power supplies are covered for a period of one (1) year; touchscreen display and overlay components are covered for 90 days; batteries and incandescent lamps are not covered.

This warranty extends to products purchased directly from CRESTRON or an authorized CRESTRON dealer. Purchasers should inquire of the dealer regarding the nature and extent of the dealer's warranty, if any.

CRESTRON shall not be liable to honor the terms of this warranty if the product has been used in any application other than that for which it was intended or if it has been subjected to misuse, accidental damage, modification or improper installation procedures. Furthermore, this warranty does not cover any product that has had the serial number altered, defaced or removed.

This warranty shall be the sole and exclusive remedy to the original purchaser. In no event shall CRESTRON be liable for incidental or consequential damages of any kind (property or economic damages inclusive) arising from the sale or use of this equipment. CRESTRON is not liable for any claim made by a third party or made by the purchaser for a third party.

CRESTRON shall, at its option, repair or replace any product found defective, without charge for parts or labor. Repaired or replaced equipment and parts supplied under this warranty shall be covered only by the unexpired portion of the warranty.

Except as expressly set forth in this warranty, CRESTRON makes no other warranties, expressed or implied, nor authorizes any other party to offer any warranty, including any implied warranties of merchantability or fitness for a particular purpose. Any implied warranties that may be imposed by law are limited to the terms of this limited warranty. This warranty statement supersedes all previous warranties.

Trademark Information

All brand names, product names and trademarks are the sole property of their respective owners. Windows is a registered trademark of Microsoft Corporation. Windows95/98/Me/XP/Vista and WindowsNT/2000 are trademarks of Microsoft Corporation.



Crestron Electronics, Inc.
15 Volvo Drive Rockleigh, NJ 07647
Tel: 888.CRESTRON
Fax: 201.767.7576
www.crestron.com

Operations Guide – DOC. 6528B
(2016140)
10.07
Specifications subject to
change without notice.