



Description

The Crestron® DIN-TSTAT-FCU is a DIN-rail mounted fan-coil unit (FCU) controller designed for use in two-pipe applications. It may be operated as a stand-alone controller or integrated with a home automation system or building management system (BMS). The DIN-TSTAT-FCU is designed to control various heating and cooling configurations.

Additional Resources

Visit the product page on the Crestron website (www.crestron.com) for additional information and the latest firmware updates. Use a QR reader application on your mobile device to scan the QR image.



Installation

Use the DIN-TSTAT-FCU in a well-ventilated area. The venting holes should not be obstructed under any circumstances. The DIN-TSTAT-FCU mounts to a DIN rail. Refer to the following diagram when installing.

To install the DIN-TSTAT-FCU, press it onto the DIN rail until it snaps into place.

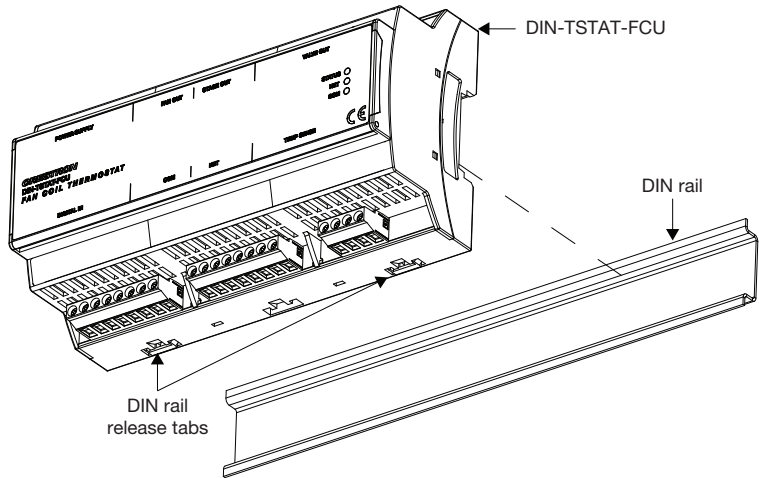

To remove the DIN-TSTAT-FCU from the DIN rail, use a small, flat object (such as a flat-head screwdriver) to pull the DIN rail release tabs, and then tilt the bottom of the DIN-TSTAT-FCU away from the DIN rail.

NOTE: Certain third-party DIN cabinets provide space for an informational label between each DIN rail row. Crestron's Engraver software (version 4.0 or later) can generate appropriate labels for all Crestron DIN rail products.

Fan Coil Types

The DIN-TSTAT-FCU is a universal FCU controller designed for use in 2-pipe applications. The DIN-TSTAT-FCU supports the following FCU types:

- Modulating 24 Vac valve
- 3-point 24 Vac valve
- Spring-return 24 Vac valve
- 3-point 230 Vac valve
- Spring-return 230 Vac Valve
- 1-2 Stage Direct-expansion system

NOTE: All set points values for valve, fan speed, and temperature are defined by setting various parameters according to the customer's needs.

NOTE: For details on controlling the fan speed, refer to the "Fan Speed Control" section.

Modulating 24 Vac Valve

This device is designed for use with a 2-pipe, 3-speed FCU with a 24 Vac modulating valve.

In this case, the valve performs regulation in the ΔT vicinity of set point. The valve opens and closes according to the graph below. The valve is controlled using 0-10 Vdc analog output.

A diagram of valve operation according to room temperature is shown below.

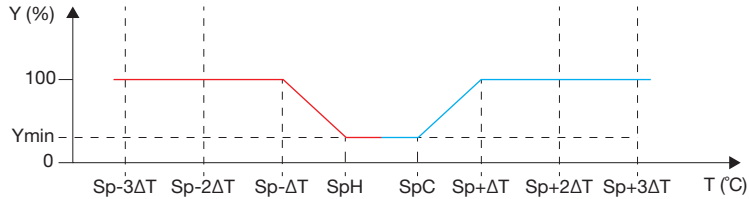

- SpH - Set point for heating
- SpC - Set point for cooling
- Y - Valve position (0% closed, 100% fully open)
- Ymin - Minimum position of valve when set point is reached
- T - Room temperature
- ΔT - Step of temperature difference ($\Delta T = N \cdot 0.5^\circ\text{C}$, where N is a settable parameter)

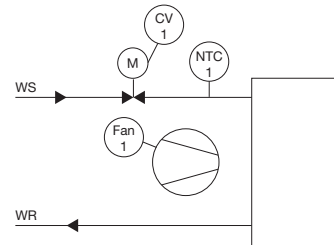

POWER SUPPLY: 230 Vac power input for line, neutral, and earth
FAN OUT: L1 - 230 Vac power input; FL, FM, FH - fan speed output
VALVE OUT: 24 Vac valve power supply; 0-10 Vdc control voltage

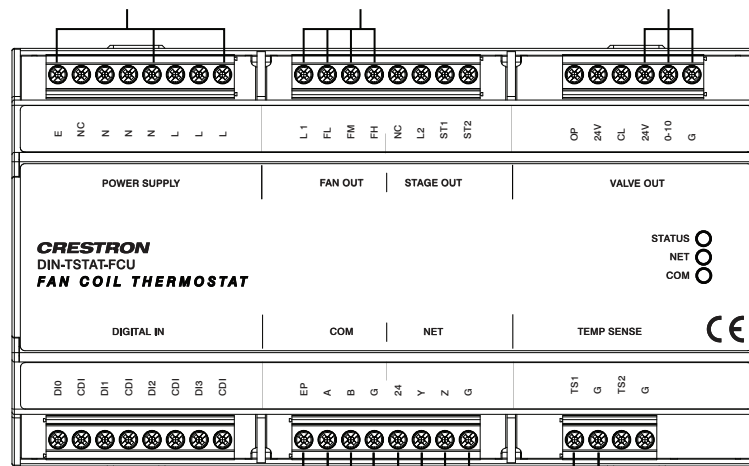

COM: Local bus (room controller)
NET: Cresnet bus
TEMP SENSE: Temperature probe input

3-point 24 Vac Valve

This device is designed for use with a 2-pipe, 3-speed FCU with 24 Vac common open/close valve.

In this case, the valve performs regulation in the ΔT vicinity of set point; the valve opens and closes at the rate of its defined time, according to the graph below.

Periodically, the valve is forced to the fully open position to eliminate accumulated error. The error correction period is defined by the *Reset valve error interval* parameter. The valve is controlled using two triac outputs (valve open - open and valve close - close).

A diagram of valve operation according to room temperature is shown below.

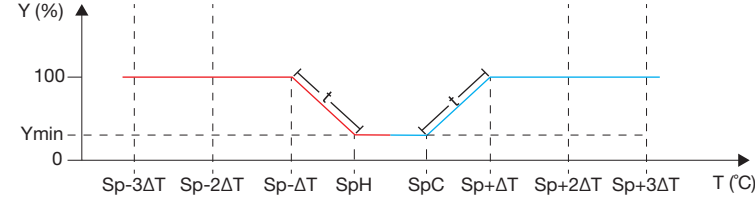

- SpH - Set point for heating
- SpC - Set point for cooling
- Y - Valve position (0% closed, 100% fully open)
- Ymin - Minimum position of valve when the set point is reached
- T - Room temperature
- ΔT - Step of temperature difference ($\Delta T = N \cdot 0.5^\circ\text{C}$, where N is a settable parameter)

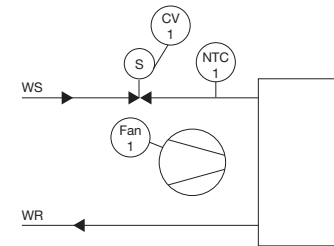

POWER SUPPLY: 230 Vac power input for line, neutral, and earth
FAN OUT: L1 - 230 Vac power input; FL, FM, FH - fan speed output
VALVE OUT: 24 Vac valve OP/CL control and power supply

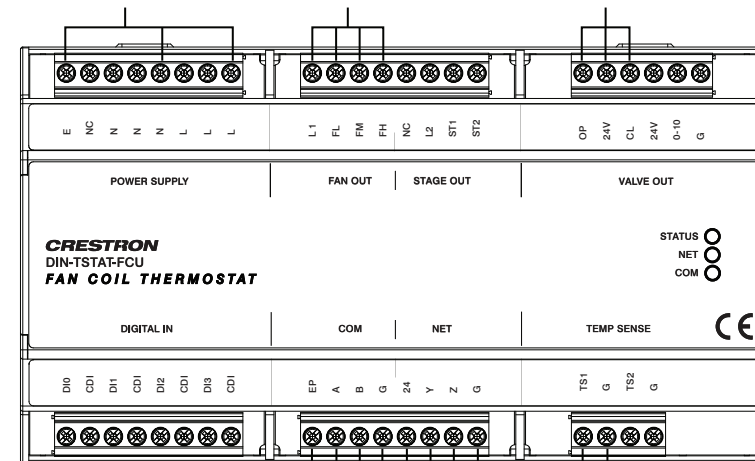

COM: Local bus (room controller)
NET: Cresnet bus
TEMP SENSE: Temperature probe input

Spring-return 24 Vac Valve

This device is designed for use with a 2-pipe, 3-speed FCU with spring-return 24 Vac valve.

In this case, the valve operates as an on and off valve. The valve value is calculated according to room temperature, as shown in the graphs below. The valve is controlled using one triac output (valve open).

A diagram of valve operation according to room temperature is shown below.

Valve Position According to Room Temperature – Cooling

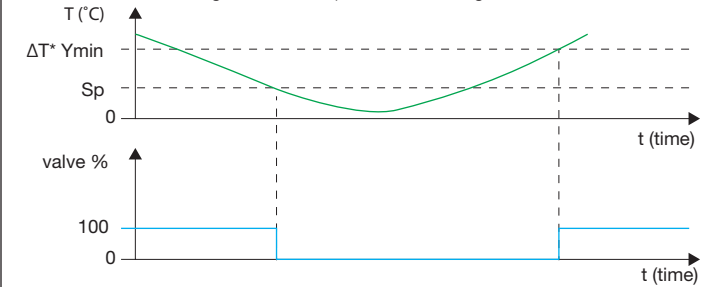

Valve Position According to Room Temperature – Heating

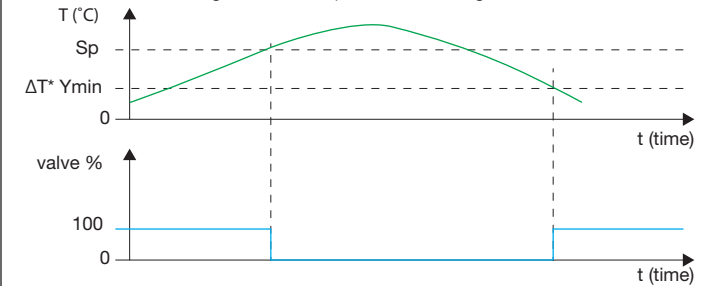

- Sp - Set point
- ΔT - Step of temperature difference ($\Delta T = N \cdot 0.5^\circ\text{C}$, where N is a settable parameter)
- t - time

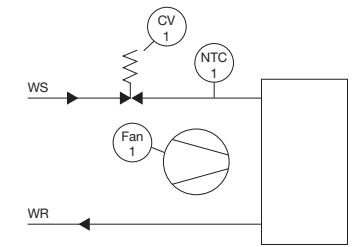

POWER SUPPLY: 230 Vac power input for line, neutral, and earth
FAN OUT: L1 - 230 Vac power input; FL, FM, FH - fan speed output
VALVE OUT: 24 Vac valve OP control and power supply

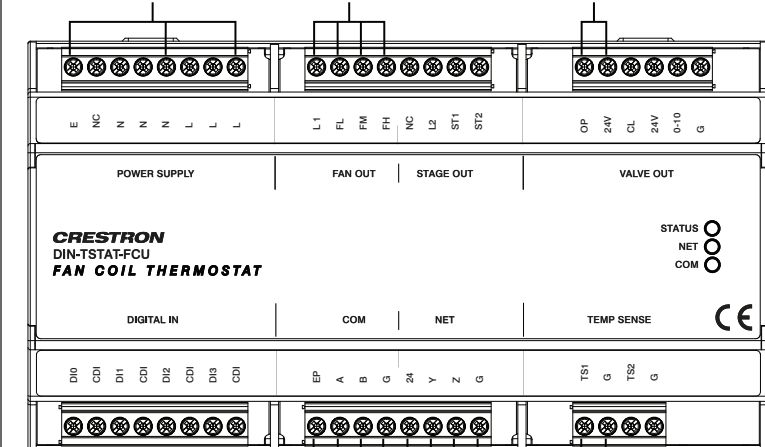

COM: Local bus (room controller)
NET: Cresnet bus
TEMP SENSE: Temperature probe input

3-point 230 Vac Valve

This device is designed for use with a 2-pipe, 3-speed FCU with 230 Vac common open/close valve.

In this case, the valve performs regulation in the ΔT vicinity of set point; the valve opens and closes at the rate of its defined time, according to the graph below.

Periodically, the valve is forced to the fully open position to eliminate accumulated error. Error annulation period is defined by the *Reset valve error interval* parameter. The valve is controlled using two relay outputs (Stg 1 - open, Stg 2 - close).

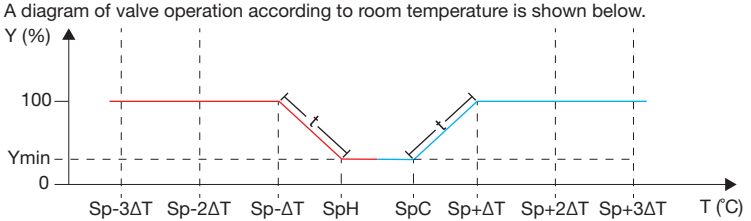

- SpH - Set point for heating
- SpC - Set point for cooling
- Y - Valve position (0% closed, 100% fully open)
- Ymin - Minimum position of valve when the set point is reached
- T - Room temperature
- ΔT - Step of temperature difference ($\Delta T=N \cdot 0.5 \text{ }^\circ\text{C}$, where N is a settable parameter)

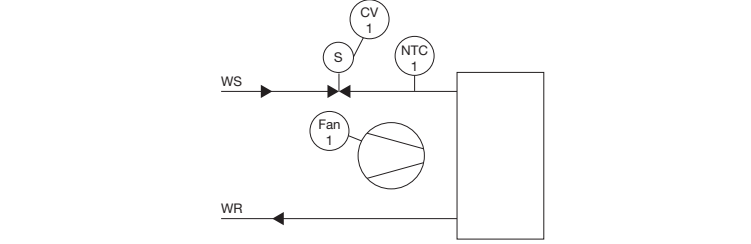

POWER SUPPLY: 230 Vac power input for line, neutral, and earth
FAN OUT: L1 - 230 Vac power input; FL, FM, FH - fan speed output
STAGE OUT: L2 - 230 Vac valve power input; ST1 - OP, ST2 - CL valve control

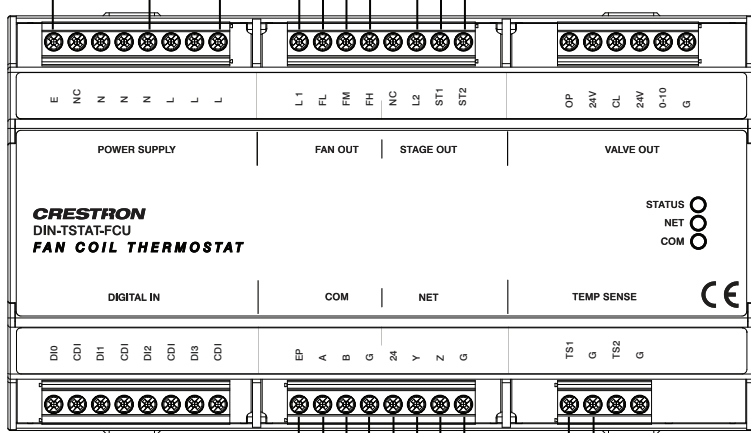

COM: Local bus (room controller)
NET: Cresnet bus
TEMP SENSE: Temperature probe input

Spring-return 230 Vac Valve

This device is designed for use with a 2-pipe, 3-speed FCU with spring-return 230 Vac valve.

In this case, the valve operates as an on and off valve. The valve value is calculated according to room temperature, as shown in the graphs below. The valve is controlled using one relay output (Stg 1 - open).

A diagram of valve operation according to room temperature is shown below.

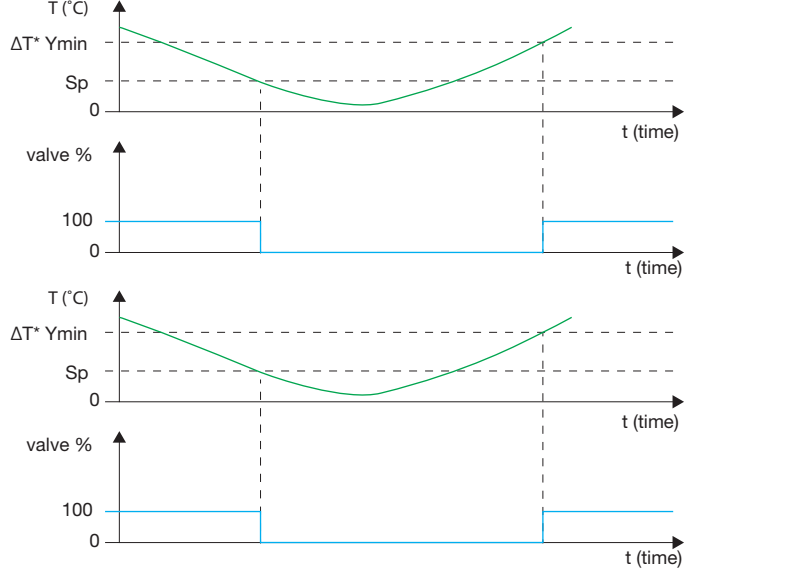

- Sp - Set point
- $\Delta T \cdot Ymin$ - Temperature when the valve is open
- t - time

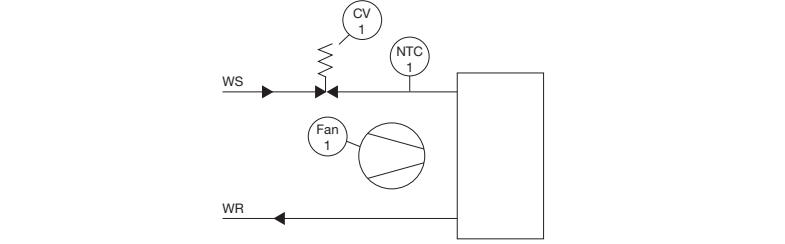

POWER SUPPLY: 230 Vac power input for line, neutral, and earth
FAN OUT: L1 - 230 Vac power input; FL, FM, FH - fan speed output
STAGE OUT: L2 - 230 Vac valve power input; ST1 - OP valve control

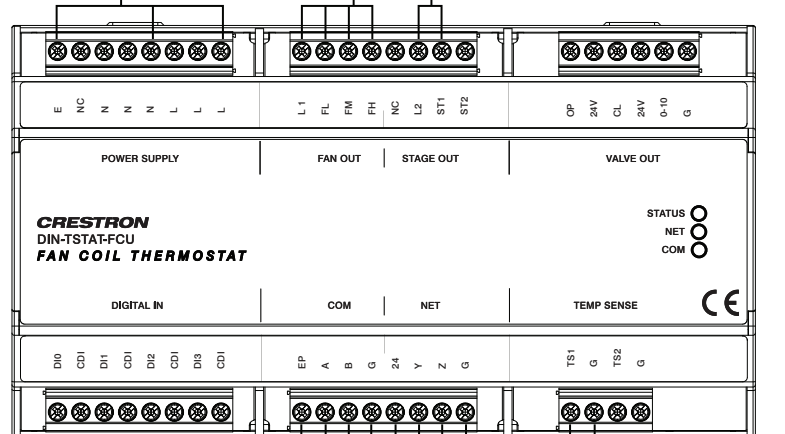

COM: Local bus (room controller)
NET: Cresnet bus
TEMP SENSE: Temperature probe input

1-2 Stage Direct-expansion System

This device is designed for use with a 3-speed, direct-expansion system with compressor control - cooling only.

In this case, a compressor is controlled instead of a valve. The compressor state for stage one and stage two is determined by the room temperature. The compressor is controlled using two relay outputs (Stg 1 - stage 1, Stg 2 - stage 2).

A diagram of compressor action according to room temperature is shown below.

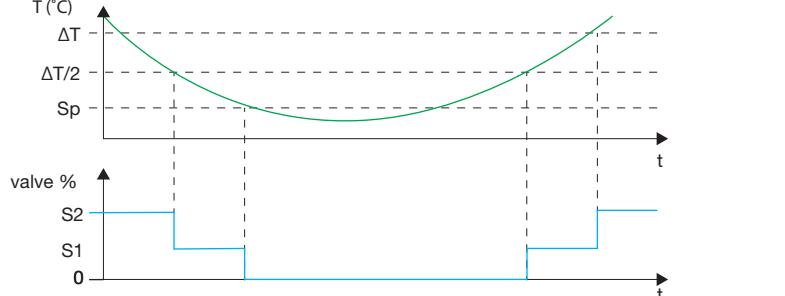

- Sp - Set point
- ΔT - Step of temperature difference ($\Delta T=N \cdot 0.5$, where N is a settable parameter)
- S2 - Stage 2 on
- S1 - Stage 1 on
- t - time

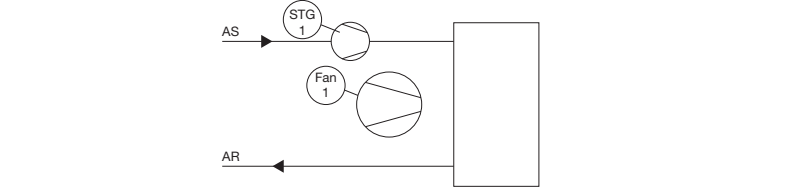

POWER SUPPLY: 230 Vac power input for line, neutral, and earth
FAN OUT: L1 - 230 Vac power input; FL, FM, FH - fan speed output
STAGE OUT: L2 - 230 Vac power input; ST1, ST2 - compressor control

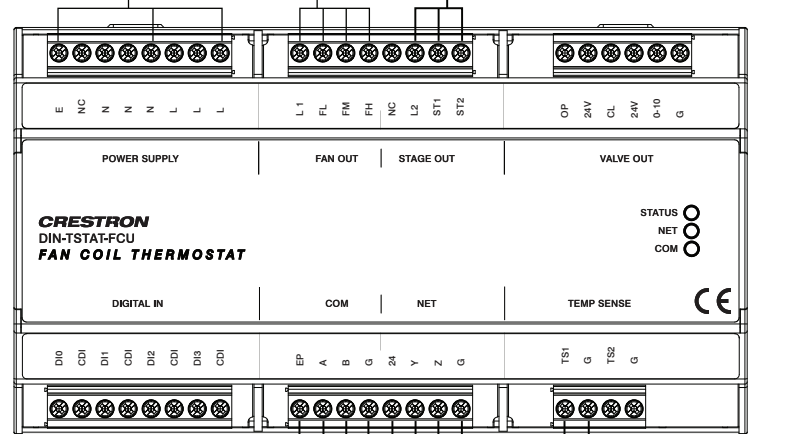

COM: Local bus (room controller)
NET: Cresnet bus
TEMP SENSE: Temperature probe input

Heater Control

This device is capable of controlling an electrical heater in all configurations except in Type 6 (1-2 stage direct-expansion system). The heater is enabled in the *Heating algorithm* parameter. The possible values are:

- 0 - only water is used for heating (electrical heater is not enabled)
- 1 - only electrical heater is used for heating
- 2 - electrical heater is used to supplement heating with water

For more information on heater control refer to the DIN-TSTAT-FCU Setup and Commissioning Guide (Doc. 8207) at www.crestron.com/manuals.

Fan Speed Control

For all configurations, the fan speed shifts to low, medium, and high based on room temperature. When a room temperature reaches its set point, the fan either shuts down or the fan turns on low.

If the fan speed is forced, the fan constantly runs at the selected speed.

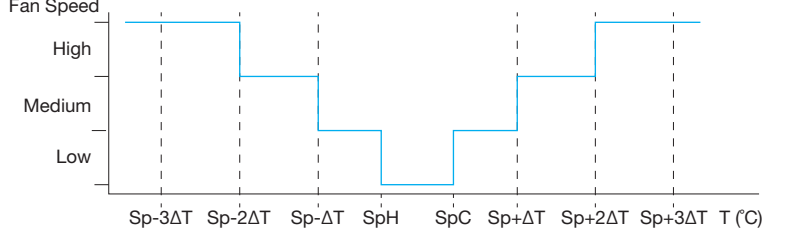

- SpH - Set point for heating
- SpC - Set point for cooling
- T - Room temperature
- ΔT - Step of temperature difference ($\Delta T=N \cdot 0.5 \text{ }^\circ\text{C}$, N is settable parameter)

Water Temperature

The second TEMP SENSE input can be used for water temperature measurement. Parameters can be set to determine the minimum temperature difference between the ambient temperature of the room and the water temperature for the FCU to effectively perform its function. When cooling is performed, the device ensures that the water in the system is adequately cooler than the ambient temperature. When heating is performed, the device ensures that the water in the system is adequately warmer than the ambient temperature. If the water temperature is not adequate, the fan is turned off and the valve is fully opens.

Digital Inputs

The device has four digital inputs that act as alarm inputs. Alarm inputs are used for accepting contacts from a window or door sensor, condensation canister full sensor, PIR sensor, etc.

If using the digital inputs, configure them using the settable parameters. When a digital input is activated, it blocks the device outputs. For example, fan speed will be set to 0 and valve will be shut.

There are three parameters available for each digital input:

- Enable - alarm is used or unused
- Polarity - alarm active state
- Delay - time from alarm activation to blocking the outputs

POWER SUPPLY: Power input for line, neutral, and earth

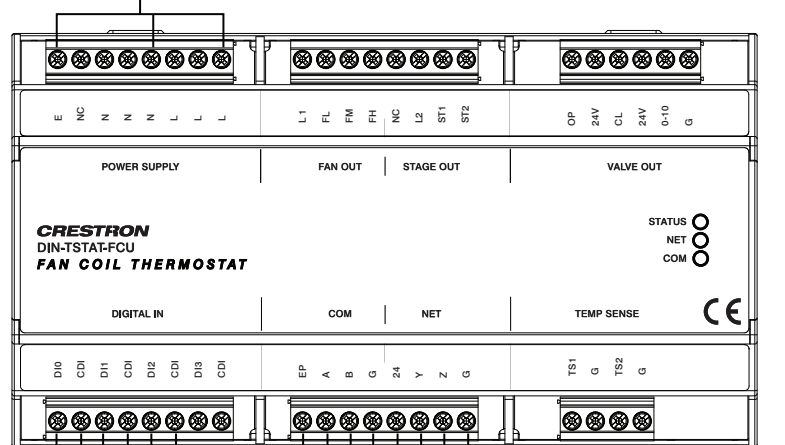

DIGITAL IN: From the window switch, door switch, or occupancy sensor
COM: Local bus (room controller)
NET: Cresnet bus

Commission the System

The DIN-TSTAT-FCU is set up and commissioned using the DIN-TSTAT-FCU Configuration Tool. For more information refer to the DIN-TSTAT-FCU Setup and Commissioning Guide (Doc. 8207) at www.crestron.com/manuals.