



TS-70 Series 7 in. and 10.1 in. Tabletop Touch Screens

Product Manual
Crestron Electronics, Inc.

The original language version of this document is U.S. English.
All other languages are a translation of the original document.

Regulatory Model: M201923004, M201923005

Crestron product development software is licensed to Crestron dealers and Crestron Service Providers (CSPs) under a limited nonexclusive, nontransferable Software Development Tools License Agreement. Crestron product operating system software is licensed to Crestron dealers, CSPs, and end-users under a separate End-User License Agreement. Both of these Agreements can be found on the Crestron website at www.crestron.com/legal/software_license_agreement.

The product warranty can be found at www.crestron.com/warranty.

The specific patents that cover Crestron products are listed online at www.crestron.com/legal/patents.

Certain Crestron products contain open source software. For specific information, please visit www.crestron.com/opensource.

Crestron, the Crestron logo, Crestron Fusion, Crestron Home, Crestron Toolbox, PinPoint, Rava, Smart Graphics, and XiO Cloud are either trademarks or registered trademarks of Crestron Electronics, Inc. in the United States and/or other countries. 2N is either a trademark or a registered trademark of 2N Telekomunikace in the United States and/or other countries. 22 Miles is either a trademark or a registered trademark of 22 Miles, Inc. in the United States and/or other countries. Appspace and the Appspace logo are either trademarks or registered trademarks of Appspace, Inc. in the United States and/or other countries. AskCody is either a trademark or a registered trademark of AskCody in the United States and/or other countries. Bluetooth is either a trademark or registered trademark of Bluetooth SIG, Inc. in the United States and/or other countries. EMS Software and the EMS logo are either trademarks or registered trademarks of EMS Software, LLC in the United States and/or other countries. Gingco.net is either a trademark or a registered trademark of Gingco.net in the United States and/or other countries. Envoy is either a trademark or a registered trademark of Envoy, Inc. in the United States and/or other countries. G Suite, Google, and Google Calendar are either trademarks or registered trademarks of Google, Inc. in the United States and/or other countries. Indoor Finders is either a trademark or a registered trademark of IntelliGroups, LLC in the United States and/or other countries. iOffice is either a trademark or a registered trademark of iOffice, LP in the United States and/or other countries. Kardham Digital is either a trademark or a registered trademark of Kardham Digital in the United States and/or other countries. Matrix Booking is either a trademark or a registered trademark of Matrix Booking in the United States and/or other countries. Active Directory, Microsoft, Microsoft Teams, and Office 365 are either trademarks or registered trademarks of Microsoft Corporation in the United States and/or other countries. New Wave Apps is either a trademark or a registered trademark of New Wave Apps in the United States and/or other countries. NFS is either a trademark or a registered trademark of NFS Technology Group in the United States and/or other countries. OfficeSpace is either a trademark or a registered trademark of OfficeSpace Software Inc. in the United States and/or other countries. Pepperdash is either a trademark or a registered trademark of Pepperdash Technology Corporation in the United States and/or other countries. Door Tablet is either a trademark or a registered trademark of Public.Class Limited in the United States and/or other countries. Korbyt is either a trademark or registered trademark of RMG Enterprise Solutions, Inc. in the United States and/or other countries. Robin and the Robin logo are either trademarks or registered trademarks of Robin Powered, Inc. in the United States and/or other countries. SharingCloud is either a trademark or a registered trademark of SharingCloud in the United States and/or other countries. Smartway2 is either a trademark or a registered trademark of Smartway2 Ltd. in the United States and/or other countries. Sonos is either a trademark or a registered trademark of Sonos, Inc. in the United States and/or other countries. Space Connect is either a trademark or a registered trademark of Spaceconnect Pty Ltd in the United States and/or other countries. SpacelQ is either a trademark or a registered trademark of Space IQ, LLC in the United States and/or other countries. Telelogos is either a trademark or a registered trademark of Telelogos SAS in the United States and/or other countries. EventBoard, Teem, and the Teem logo are either trademarks or registered trademarks of Teem, LLC in the United States and/or other countries. Zoom and Zoom Rooms are either trademarks or registered trademarks of Zoom Video Communications, Inc. in the United States and/or other countries. Other trademarks, registered trademarks, and trade names may be used in this document to refer to either the entities claiming the marks and names or their products. Crestron disclaims any proprietary interest in the marks and names of others. Crestron is not responsible for errors in typography or photography.

©2022 Crestron Electronics, Inc.

Contents

Overview	1
Features	1
TS-770 Features	2
TS-770-GV Features	8
TS-770R Features	13
TS-1070 Features	16
TS-1070-GV Features	22
TS-1070R Features	27
Physical Description	30
Specifications	31
TS-770 Specifications	32
Product Specifications	32
Dimension Drawings	36
TS-770-GV Specifications	38
Product Specifications	38
Dimension Drawings	41
TS-770R Specifications	43
Product Specifications	43
Dimension Drawings	46
TS-1070 Specifications	47
Product Specifications	47
Dimension Drawings	51
TS-1070-GV Specifications	53
Product Specifications	53
Dimension Drawings	56
TS-1070R Specifications	58
Product Specifications	58
Dimension Drawings	61
Installation	62
TS-770 and TS-1070 Installation	63
Place the Touch Screen	63
Connect the Touch Screen	64
Install the Cable Grommet	64
Configure the Touch Screen	65
Select an Application	69
TS-770-GV and TS-1070-GV Installation	70
Place the Touch Screen	70
Connect the Touch Screen	71
Install the Cable Grommet	71

Configure the Touch Screen	72
Select an Application	74
TS-770R and TS-1070R Installation	76
Place the Touch Screen	76
Connect the Touch Screen	77
Install the Cable Grommet	77
Configure the Touch Screen	78
Configure the Crestron Home App	80
Configuration	81
Local Configuration	82
Access the Setup Screens	82
Ethernet Setup	83
IP Table Setup	89
Audio Setup	92
Display Setup	93
Standby Timeout	95
Application Selection	97
Wi-Fi Setup	98
Bluetooth Beacon	105
Virtual Toolbar	106
Diagnostics & Advanced	109
About	119
Web Configuration	120
Actions Menu	121
Status	124
Settings	131
Security	150
802.1x Configuration	158
Application Selection	162
Connect to XiO Cloud Service	164
Operation	165
Resources	167
Crestron Support and Training	167
Programmer and Developer Resources	167
Related Documentation	167

Overview

The Crestron® [TS-770](#) and [TS-1070](#) are tabletop touch screens that feature web browsing, Smart Graphics® software and HTML5 UI technology, custom-programmable virtual buttons, H.265/H.264 streaming video, a Rava® SIP intercom, Wi-Fi® network connectivity, and PoE+ (Power over Ethernet Plus) network power. The touch screens also provide built-in applications for room scheduling, conferencing, and home control.

NOTE: The TS-770 and TS-1070 are functionally similar. For simplicity within this documentation, the term "touch screen" is used except where otherwise noted.

Crestron offers the following variations for its standard touch screen models. Certain settings described in this document are not applicable to these models.

- The [TS-770-GV](#) and [TS-1070-GV](#) series touch screens eliminate the microphone, the Bluetooth® communications beacon, and Wi-Fi network connectivity to comply with government applications demanding extra privacy and security.
- The [TS-770R](#) and [TS-1070R](#) series touch screens are designed specifically to run the Crestron Home™ OS home control application.

Features

Refer to the following sections for more information on the features provided by various TS-70 Series models.

- [TS-770 Features on page 2](#)
- [TS-770-GV Features on page 8](#)
- [TS-770R Features on page 13](#)
- [TS-1070 Features on page 16](#)
- [TS-1070-GV Features on page 22](#)
- [TS-1070R Features on page 27](#)

TS-770 Features

The Crestron® TS-770 is a stylish and versatile tabletop touch screen that is ideal for residential and enterprise applications. The TS-770 features a 7 in. (178 mm) capacitive touch screen display with custom-programmable control buttons and support for Smart Graphics® software and HTML5-based custom UI projects. PoE and Wi-Fi® network connectivity and a modern tabletop design allow the touch screen to be deployed just about anywhere.



Key features include:

- Next generation Crestron® tabletop touch screen
- 7 in. (178 mm) widescreen active-matrix color display and 1280 x 800 WXGA display resolution
- Capacitive touch screen display
- Custom-programmable virtual control buttons
- Supports Crestron HTML5 and Smart Graphics® software custom user projects
- Built-in Rava® SIP intercom
- Built-in speakers and microphone
- H.265, H.264, or MJPEG streaming video display
- Native apps for Crestron Home™ OS, Sonos® home sound control, Zoom Rooms™ conferencing control, and various room scheduling services
- Built-in Bluetooth® communications beacon
- Built-in web browsing

- Single wire Ethernet connection with PoE or PoE+ power
- Wi-Fi® network connectivity
- USB 2.0 port
- Enterprise grade security and authentication
- Web, cloud, or device-based configuration

Advanced Touch Screen Control

The TS-770 offers a sleek and powerful user interface for controlling technology in a home, boardroom, classroom, or command center. The touch screen provides an intuitive interface that is fully customizable with easy-to-use capacitive controls, true feedback, and real-time status display. A built-in proximity sensor wakes the screen without requiring any user interaction, and automatic brightness controls ensure optimal visibility under varying lighting conditions.

Custom-Programmable Virtual Buttons

The TS-770 provides a universal status bar that is populated with virtual buttons for quick access to common touch screen functions. The touch screen comes preconfigured with virtual buttons for Power, Home, Lights, Up, Down, and Microphone. Each button can be programmed via a Crestron control system to provide custom functionality, and unused buttons can be hidden individually. The universal status bar is expanded or hidden using simple swipe gestures on touch screen display.

Dynamic User Interfaces

The TS-770 supports custom user interfaces created with [Crestron HTML5 User Interface](#) and Smart Graphics technologies, allowing greater flexibility for UI developers and programmers.

- Crestron HTML5 User Interface enables UI designers to develop rich, front-end user interfaces with increased reusability and efficiency using modern web methodologies. Crestron HTML5 User Interface development tools are provided to simplify creating user interfaces built on standard web technologies
- Smart Graphics enables programmers to integrate fluid gesture-driven controls, animated feedback, rich metadata, embedded apps and widgets, and full-motion video into their user interfaces. Smart Graphics provides dynamic features such as graphical buttons and sliders, lists and toolbars, drag-and-drop objects, dashboard widgets, screensavers, and customizable themes.

Voice Recognition

With built-in voice recognition, spoken commands can be issued to the TS-770 to quickly turn devices on or off, select and play a specific media source, change the channel, choose a lighting scene, lower the window shades, lock the doors, arm the security system, or enter a password. Simply say a command and Crestron does the rest.^{1,2}

Streaming Video

Native support for H.265, H.264, and MJPEG formats allows the TS-770 to display live streaming video from an IP camera, a streaming encoder (Crestron [DM-TXRX-100-STR](#), or similar), or a [DigitalMedia™ switcher](#).³ Video is delivered to the touch screen over Ethernet, eliminating the need for any extra video wiring.

Rava SIP Intercom

[Rava SIP Intercom Technology](#) enables hands-free VoIP communication with other Rava-enabled touch screens and door stations. Rava works over Ethernet, supporting 2-way intercom and paging without requiring any special wiring. VoIP phone capability is also possible through integration with a SIP-compatible IP phone system or SIP server, allowing hands-free telephone functionality complete with speed-dialing, caller ID, custom ringers, and other enhancements. Built-in echo cancellation affords full-duplex performance for clear, seamless voice communication using the integrated microphone and speakers.²

Sonos App

[Sonos and Crestron](#) have partnered to provide a powerful whole-house music experience. From any touch screen in the house, browse for tracks, artists, or playlists using all the services available from Sonos and instantly play them in any room using Sonos® wireless speakers or a Crestron [Sonnex® multiroom audio system](#). The Sonos app runs natively on the TS-770, enabling enhanced control of Sonos products as part of a complete Crestron system. The app checks for updates nightly so it's always current, and support for the Sonos S2 App is provided.¹

Crestron Room Scheduling App

As part of a complete enterprise room scheduling solution, the TS-770 can be deployed as a scheduling panel via the Crestron room scheduling app. A Crestron scheduling panel can be installed at the entrance of a meeting room to provide indication of the room's availability and a view of its schedule for the day. If desired, the room can be reserved on the spot for an ad hoc meeting. A [CEN-ODT-C-POE](#) occupancy sensor can also be paired to the touch screen, allowing for occupancy status to be reported instantly to the scheduling app for no-shows and unscheduled room usage.^{3,4}

Running the Crestron Scheduling App, the TS-770 integrates directly with [Crestron Fusion®](#) software, Microsoft Exchange Server® software (for users of Outlook® software and Office 365® software), the Google Calendar™ calendaring app (including G Suite™ software), CollegeNET® 25Live® scheduling software, or Ad Astra™ software. IBM® Notes® software is also supported through a Crestron Fusion on-premises server.

Third-Party Scheduling Apps

The TS-770 also includes support various third-party scheduling applications. New providers are made available via firmware updates. Whatever provider you choose, setup is as simple as connecting the touch screen to the network and choosing an app from the web-based setup menu or built-in setup screens. The selected app downloads from the cloud and installs on the touch screen without any programming or control system required.^{5,6}

Zoom Rooms App

The [Zoom Rooms™](#) conferencing control application enables the TS-770 to be used as a touch screen control panel for a Zoom Rooms software-based conferencing and collaboration solution. The TS-770 offers a superior alternative to a consumer tablet device, providing a more reliable and secure platform. The TS-770 may be configured to run the Zoom Rooms app exclusively, or to allow toggling between the Zoom Rooms app and touch screen control mode. The latter option is used to integrate Zoom Rooms conferencing into a larger AV system while providing touch screen control for both.⁷

NOTE: The Zoom ultrasonic proximity signal is supported up to an average of 9 ft (2.74 m) from the TS-770 touch screen to an end user device. The range will vary based on environmental noise, the sensitivity of the end user device, and the orientation to the touch screen.

Crestron Home OS Control

The TS-770 may be used to control a [Crestron Home™ OS](#) whole home solution. Select the Crestron Home app from the touch screen to control lighting, shades, climate, media, security, and cameras, including the ability to create and recall scenes that create a desired ambiance throughout a home. A TS-770 may be installed in each room to provide easy access to various Crestron Home functions for both the room and the home.

Bluetooth Beacon

The built-in Bluetooth® proximity detection beacon enhances the intelligence and personalization of a Crestron system by enabling a smartphone or tablet device to always know what room it is in. It works with the Crestron Go App and Crestron App to determine when the mobile device is in or near the same room as the beacon, and signals the mobile app to automatically display the appropriate controls and information for the room.^{2,8}

Web Browsing

Using its built-in web browser, the TS-770 provides access to online program guides and other web-based services, and it can be used to control DVRs and other devices without having to pick up a separate tablet or smartphone.¹

Wired and Wi-Fi Connectivity

An Ethernet LAN connection is all that is required to wire the TS-770, containing all control, video, intercom, and power signals within a single wire.

For deployments without access to Ethernet, the touch screen can also be connected the network over Wi-Fi communications via a local wireless access point (WAP).

Power over Ethernet

Using PoE technology, the TS-770 gets its operating power directly through the network cable. PoE (Power over Ethernet) eliminates the need for a local power supply or any dedicated power wiring. Crestron PoE switches ([CEN-SW-POE-5](#) or [CEN-SWPOE-16](#)³) offer a total networking solution with built-in PoE for multiple touch screens. A PoE Injector ([PWE-4803RU](#)³) is also available to support a single touch screen.

NOTE: Refer to the "Power" specifications for more details.

High-Speed USB Port

The TS-770 provides a high-speed USB 2.0 port for connecting supported Crestron accessories to the touch screen.³

Enterprise-Grade Security

Crestron touch screens employ enterprise-grade networking with robust security features such as 802.1X authentication, TLS encryption, HTTPS connectivity, and Active Directory® service integration. These features are imperative to protect your network against service interruptions and malicious intrusions, and to ensure compliance with your organization's network policies. Cloud-based provisioning and management streamlines the process of configuring, monitoring, and updating every touch screen on the network. Additional support for SNMP allows the touch screen to be monitored by your IT administrator.

XiO Cloud Service

The TS-770 is compatible with the XiO Cloud® service, which is an IoT (Internet of Things) based platform for remotely provisioning, monitoring, and managing Crestron devices across an enterprise or an entire client base. Built on the Microsoft® Azure® software platform and utilizing Microsoft's industry-leading Azure IoT Hub technology, XiO Cloud enables installers and IT managers to deploy and manage thousands of devices in the time it previously took to manage just one. Unlike other virtual machine-based cloud solutions, Azure services provide unlimited scalability to suit the ever-growing needs of an enterprise. For more information, visit www.crestron.com/xiocloud.

Crestron ONE App Support

The TS-770 is compatible with the [Crestron ONE™ mobile room control app](#). The Crestron ONE app creates a peer-to-peer network over Bluetooth communications between a mobile device and the TS-770 in the room, allowing mobile-optimized room controls to be pushed to the device from the touch screen. Programmers can specify the controls that display on the mobile app by mapping joins from Smart Graphics projects to the mobile project. A [SW-MOBILITY](#) license is required to enable mobile room control functionality.

Optional Mounting Accessories

The [TS-770/1070-SMK](#) allows the touch screen to be mounted permanently to a tabletop and permits up to 330 degree swivel rotation.

Notes:

1. Voice recognition, web browsing, weather information, and certain other functions require an internet connection.
2. The microphone and Bluetooth® transceiver may be defeated programmatically at any time.
3. Item(s) sold separately. Refer to each product's spec sheet for complete information.
4. Room scheduling mode requires the TS-770 to be designated exclusively for room scheduling use, which precludes use of certain features and functions described in this spec sheet. Additionally, CollegeNET® 25Live® scheduling software and Ad Astra™ software do not support scheduling ad hoc meetings from the touch screen. For design assistance, contact the Crestron True Blue support team at www.crestron.com/support.
5. Refer to the firmware release notes for a list of all scheduling apps that are supported by that firmware release.
6. Additional subscriptions and/or licenses may be required. Refer to each provider's website for details about the capabilities and requirements of its scheduling application and services. Third-party apps typically run on the TS-770 as they do on a tablet device. The TS-770 runs only one app, which is selected at setup. Only the apps approved and delivered by Crestron can run on the TS-770.
7. A complete Zoom Rooms solution requires a mini PC or Mac computer running Zoom software, a Zoom Rooms subscription, plus additional peripherals and cables. Visit zoom.us/zoomrooms for more information about Zoom Rooms capabilities, hardware requirements, and subscription plans. For design assistance, contact the Crestron True Blue support team at www.crestron.com/support.
8. The TS-770 provides an integrated, equivalent alternative to the standalone [PP-100-W](#) beacon. For more details, refer to the PP-100-W spec sheet. Bluetooth technology is used solely for proximity detection and does not transmit or receive any control, multimedia, or personal data. Crestron Bluetooth beacons are only visible to Bluetooth enabled devices that are specifically programmed and configured to work with them.

TS-770-GV Features

The Crestron® TS-770-GV is a stylish and versatile tabletop touch screen that is ideal for residential and enterprise applications. The TS-770-GV features a 7 in. (178 mm) capacitive touch screen display with custom-programmable control buttons and support for Smart Graphics® software and HTML5-based custom UI projects. PoE connectivity and a modern tabletop design allow the touch screen to be deployed just about anywhere.

NOTE: The TS-770-GV series is a modified version of the TS-770 series, which eliminates the microphone, the Bluetooth® communications beacon, and Wi-Fi® network connectivity to comply with government applications demanding extra privacy and security.



Key features include:

- Next generation Crestron® tabletop touch screen
- 7 in. (178 mm) widescreen active-matrix color display and 1280 x 800 WXGA display resolution
- Capacitive touch screen display
- Custom-programmable virtual control buttons
- Supports Crestron HTML5 and Smart Graphics® software custom user projects
- Built-in speakers
- H.265, H.264, or MJPEG streaming video display
- Built-in web browsing

- Single wire Ethernet connection with PoE or PoE+ power
- USB 2.0 port
- Enterprise grade security and authentication
- Web or device-based configuration

Advanced Touch Screen Control

The TS-770-GV offers a sleek and powerful user interface for controlling technology in a home, boardroom, classroom, or command center. The touch screen provides an intuitive interface that is fully customizable with easy-to-use capacitive controls, true feedback, and real-time status display. A built-in proximity sensor wakes the screen without requiring any user interaction, and automatic brightness controls ensure optimal visibility under varying lighting conditions.

Custom-Programmable Virtual Buttons

The TS-770-GV provides a universal status bar that is populated with virtual buttons for quick access to common touch screen functions. The touch screen comes preconfigured with virtual buttons for Power, Home, Lights, Up, and Down. Each button can be programmed via a Crestron control system to provide custom functionality, and unused buttons can be hidden individually. The universal status bar is expanded or hidden using simple swipe gestures on touch screen display.

Dynamic User Interfaces

The TS-770-GV supports custom user interfaces created with [Crestron HTML5 User Interface](#) and Smart Graphics technologies, allowing greater flexibility for UI developers and programmers.

- Crestron HTML5 User Interface enables UI designers to develop rich, front-end user interfaces with increased reusability and efficiency using modern web methodologies. Crestron HTML5 User Interface development tools are provided to simplify creating user interfaces built on standard web technologies
- Smart Graphics enables programmers to integrate fluid gesture-driven controls, animated feedback, rich metadata, embedded apps and widgets, and full-motion video into their user interfaces. Smart Graphics provides dynamic features such as graphical buttons and sliders, lists and toolbars, drag-and-drop objects, dashboard widgets, screensavers, and customizable themes.¹

Streaming Video

Native support for H.265, H.264, and MJPEG formats allows the TS-770-GV to display live streaming video from an IP camera, a streaming encoder (Crestron [DM-TXRX-100-STR](#), or similar), or a [DigitalMedia™ switcher](#).² Video is delivered to the touch screen over Ethernet, eliminating the need for any extra video wiring.

Sonos App

[Sonos and Crestron](#) have partnered to provide a powerful whole-house music experience. From any touch screen in the house, browse for tracks, artists, or playlists using all the services available from Sonos and instantly play them in any room using Sonos® wireless speakers or a Crestron [Sonnex® multiroom audio system](#). The Sonos app runs natively on the TS-770-GV, enabling enhanced control of Sonos products as part of a complete Crestron system. The app checks for updates nightly so it's always current, and support for the Sonos S2 App is provided.¹

Crestron Room Scheduling App

As part of a complete enterprise room scheduling solution, the TS-770-GV can be deployed as a scheduling panel via the Crestron room scheduling app. A Crestron scheduling panel can be installed at the entrance of a meeting room to provide indication of the room's availability and a view of its schedule for the day. If desired, the room can be reserved on the spot for an ad hoc meeting. A [CEN-ODT-C-POE](#) occupancy sensor can also be paired to the touch screen, allowing for occupancy status to be reported instantly to the scheduling app for no-shows and unscheduled room usage.^{2,3}

Running the Crestron Scheduling App, the TS-770-GV integrates directly with [Crestron Fusion®](#) software, Microsoft Exchange Server® software (for users of Outlook® software and Office 365® software), the Google Calendar™ calendaring app (including G Suite™ software), CollegeNET® 25Live® scheduling software, or Ad Astra™ software. IBM® Notes® software is also supported through a Crestron Fusion on-premises server.

Third-Party Scheduling Apps

The TS-770-GV also includes support various third-party scheduling applications. New providers are made available via firmware updates. Whatever provider you choose, setup is as simple as connecting the touch screen to the network and choosing an app from the web-based setup menu or built-in setup screens. The selected app downloads from the cloud and installs on the touch screen without any programming or control system required.^{4,5}

Zoom Rooms App

The [Zoom Rooms™](#) conferencing control application enables the TS-770-GV to be used as a touch screen control panel for a Zoom Rooms software-based conferencing and collaboration solution. The TS-770-GV offers a superior alternative to a consumer tablet device, providing a more reliable and secure platform. The TS-770-GV may be configured to run the Zoom Rooms app exclusively, or to allow toggling between the Zoom Rooms app and touch screen control mode. The latter option is used to integrate Zoom Rooms conferencing into a larger AV system while providing touch screen control for both.⁶

NOTE: The Zoom ultrasonic proximity signal is supported up to an average of 9 ft (2.74 m) from the TS-770-GV touch screen to an end user device. The range will vary based on environmental noise, the sensitivity of the end user device, and the orientation to the touch screen.

Crestron Home OS Control

The TS-770-GV may be used to control a [Crestron Home™ OS](#) whole home solution. Select the Crestron Home app from the touch screen to control lighting, shades, climate, media, security, and cameras, including the ability to create and recall scenes that create a desired ambiance throughout a home. A TS-770-GV may be installed in each room to provide easy access to various Crestron Home functions for both the room and the home.

Web Browsing

Using its built-in web browser, the TS-770-GV provides access to online program guides and other web-based services, and it can be used to control DVRs and other devices without having to pick up a separate tablet or smartphone.¹

Wired Connectivity

An Ethernet LAN connection is all that is required to wire the TS-770-GV, containing all control, video, intercom, and power signals within a single wire.

Power over Ethernet

Using PoE technology, the TS-770-GV gets its operating power directly through the network cable. PoE (Power over Ethernet) eliminates the need for a local power supply or any dedicated power wiring. Crestron PoE switches ([CEN-SW-POE-5](#) or [CEN-SWPOE-16](#)) offer a total networking solution with built-in PoE for multiple touch screens. A PoE Injector ([PWE-4803RU](#)) is also available to support a single touch screen.

NOTE: Refer to the “Power” specifications for more details.

High-Speed USB Port

The TS-770-GV provides a high-speed USB 2.0 port for connecting supported Crestron accessories to the touch screen.²

Enterprise-Grade Security

Crestron touch screens employ enterprise-grade networking with robust security features such as 802.1X authentication, TLS encryption, HTTPS connectivity, and Active Directory® service integration. These features are imperative to protect your network against service interruptions and malicious intrusions, and to ensure compliance with your organization’s network policies. Cloud-based provisioning and management streamlines the process of configuring, monitoring, and updating every touch screen on the network. Additional support for SNMP allows the touch screen to be monitored by your IT administrator.

Optional Mounting Accessories

The [TS-770/1070-SMK](#) allows the touch screen to be mounted permanently to a tabletop and permits up to 330 degree swivel rotation.

Notes:

1. Web browsing, weather information, and certain other functions require an internet connection.
2. Item(s) sold separately. Refer to each product's spec sheet for complete information.
3. Room scheduling mode requires the TS-770-GV to be designated exclusively for room scheduling use, which precludes use of certain features and functions described in this spec sheet. Additionally, CollegeNET® 25Live® scheduling software and Ad Astra™ software do not support scheduling ad hoc meetings from the touch screen. For design assistance, contact the Crestron True Blue support team at www.crestron.com/support.
4. Refer to the firmware release notes for a list of all scheduling apps that are supported by that firmware release.
5. Additional subscriptions and/or licenses may be required. Refer to each provider's website for details about the capabilities and requirements of its scheduling application and services. Third-party apps typically run on the TS-770-GV as they do on a tablet device. The TS-770-GV runs only one app, which is selected at setup. Only the apps approved and delivered by Crestron can run on the TS-770-GV.
6. A complete Zoom Rooms solution requires a mini PC or Mac computer running Zoom software, a Zoom Rooms subscription, plus additional peripherals and cables. Visit zoom.us/zoomrooms for more information about Zoom Rooms capabilities, hardware requirements, and subscription plans. For design assistance, contact the Crestron True Blue support team at www.crestron.com/support.

TS-770R Features

The Crestron® TS-770R is a stylish and versatile tabletop touch screen that is designed specifically to run the Crestron Home™ OS application. The TS-770R features a 7 in. (178 mm) capacitive touch screen display. PoE and Wi-Fi® network connectivity and a modern tabletop design allow the touch screen to be deployed just about anywhere.



Key features include:

- Next generation Crestron® tabletop touch screen featuring a native Crestron Home™ OS application
- 7 in. (178 mm) widescreen active-matrix color display and 1280 x 800 WXGA display resolution
- Capacitive touch screen display
- Built-in Rava® SIP intercom
- Built-in speakers and microphone
- H.265, H.264, or MJPEG streaming video display
- Single wire Ethernet connection with PoE or PoE+ power
- Wi-Fi® network connectivity
- USB 2.0 port
- Enterprise grade security and authentication
- Web or device-based configuration

Advanced Touch Screen Control

The TS-770R offers a sleek and powerful user interface for controlling technology in the home via the Crestron Home app. The touch screen provides an intuitive interface that is fully customizable with easy-to-use capacitive controls, true feedback, and real-time status display. A built-in proximity sensor wakes the screen without requiring any user interaction, and automatic brightness controls ensure optimal visibility under varying lighting conditions.

Streaming Video

Native support for H.265, H.264, and MJPEG formats allows the TS-770R to display live streaming video from an IP camera, a streaming encoder (Crestron [DM-TXRX-100-STR](#), or similar), or a [DigitalMedia™ switcher](#).³ Video is delivered to the touch screen over Ethernet, eliminating the need for any extra video wiring.

Rava SIP Intercom

[Rava SIP Intercom Technology](#) enables hands-free VoIP communication with other Rava-enabled touch screens and door stations. Rava works over Ethernet, supporting 2-way intercom and paging without requiring any special wiring. VoIP phone capability is also possible through integration with a SIP-compatible IP phone system or SIP server, allowing hands-free telephone functionality complete with speed-dialing, caller ID, custom ringtones, and other enhancements. Built-in echo cancellation affords full-duplex performance for clear, seamless voice communication using the integrated microphone and speakers.²

Sonos App

[Sonos and Crestron](#) have partnered to provide a powerful whole-house music experience. From any touch screen in the house, browse for tracks, artists, or playlists using all the services available from Sonos and instantly play them in any room using Sonos® wireless speakers or a Crestron [Sonnex® multiroom audio system](#). The Sonos app runs natively on the TS-770R, enabling enhanced control of Sonos products as part of a complete Crestron system. The app checks for updates nightly so it's always current, and support for the Sonos S2 App is provided.¹

Crestron Home OS Control

The TS-770R may be used to control a [Crestron Home™ OS](#) whole home solution. Select the Crestron Home app from the touch screen to control lighting, shades, climate, media, security, and cameras, including the ability to create and recall scenes that create a desired ambiance throughout a home. A TS-770R may be installed in each room to provide easy access to various Crestron Home functions for both the room and the home.

Wired and Wi-Fi Connectivity

An Ethernet LAN connection is all that is required to wire the TS-770R, containing all control, video, intercom, and power signals within a single wire.

For deployments without access to Ethernet, the touch screen can also be connected the network over Wi-Fi communications via a local wireless access point (WAP).

Power over Ethernet

Using PoE technology, the TS-770R gets its operating power directly through the network cable. PoE (Power over Ethernet) eliminates the need for a local power supply or any dedicated power wiring. Crestron PoE switches ([CEN-SW-POE-5](#) or [CEN-SWPOE-16](#)³) offer a total networking solution with built-in PoE for multiple touch screens. A PoE Injector ([PWE-4803RU](#)³) is also available to support a single touch screen.

NOTE: Refer to the “Power” specifications for more details.

Enterprise-Grade Security

Crestron touch screens employ enterprise-grade networking with robust security features such as 802.1X authentication, TLS encryption, HTTPS connectivity, and Active Directory® service integration.

Optional Mounting Accessories

The [TS-770/1070-SMK](#) allows the touch screen to be mounted permanently to a tabletop and permits up to 330 degree swivel rotation.

Notes:

1. Certain other functions require an internet connection.
2. The microphone may be defeated programmatically at any time.
3. Item(s) sold separately. Refer to each product's spec sheet for complete information.

TS-1070 Features

The Crestron® TS-1070 is a stylish and versatile tabletop touch screen that is ideal for residential and enterprise applications. The TS-1070 features a 10.1 in. (257 mm) capacitive touch screen display with custom-programmable control buttons and support for Smart Graphics® software and HTML5-based custom UI projects. PoE and Wi-Fi® network connectivity and a modern tabletop design allow the touch screen to be deployed just about anywhere.



Key features include:

- Next generation Crestron® tabletop touch screen
- 10.1 in. (257 mm) widescreen active-matrix color display and 1920 x 1200 WUXGA display resolution
- Capacitive touch screen display
- Custom-programmable virtual control buttons
- Supports Crestron HTML5 and Smart Graphics® software custom user projects
- Built-in Rava® SIP intercom
- Built-in speakers and microphone
- H.265, H.264, or MJPEG streaming video display

- Native apps for Crestron Home™ OS, Sonos® home sound control, Zoom Rooms™ conferencing control, Microsoft Teams® online meeting solution, and various room scheduling services
- Built-in Bluetooth® communications beacon
- Built-in web browsing
- Single wire Ethernet connection with PoE or PoE+ power
- Wi-Fi® network connectivity
- USB 2.0 port
- Enterprise grade security and authentication
- Web, cloud, or device-based configuration

Advanced Touch Screen Control

The TS-1070 offers a sleek and powerful user interface for controlling technology in a home, boardroom, classroom, or command center. The touch screen provides an intuitive interface that is fully customizable with easy-to-use capacitive controls, true feedback, and real-time status display. A built-in proximity sensor wakes the screen without requiring any user interaction, and automatic brightness controls ensure optimal visibility under varying lighting conditions.

Custom-Programmable Virtual Buttons

The TS-1070 provides a universal status bar that is populated with virtual buttons for quick access to common touch screen functions. The touch screen comes preconfigured with virtual buttons for Power, Home, Lights, Up, Down, and Microphone. Each button can be programmed via a Crestron control system to provide custom functionality, and unused buttons can be hidden individually. The universal status bar is expanded or hidden using simple swipe gestures on touch screen display.

Dynamic User Interfaces

The TS-1070 supports custom user interfaces created with [Crestron HTML5 User Interface](#) and Smart Graphics technologies, allowing greater flexibility for UI developers and programmers.

- Crestron HTML5 User Interface enables UI designers to develop rich, front-end user interfaces with increased reusability and efficiency using modern web methodologies. Crestron HTML5 User Interface development tools are provided to simplify creating user interfaces built on standard web technologies
- Smart Graphics enables programmers to integrate fluid gesture-driven controls, animated feedback, rich metadata, embedded apps and widgets, and full-motion video into their user interfaces. Smart Graphics provides dynamic features such as graphical buttons and sliders, lists and toolbars, drag-and-drop objects, dashboard widgets, screensavers, and customizable themes.

Voice Recognition

With built-in voice recognition, spoken commands can be issued to the TS-1070 to quickly turn devices on or off, select and play a specific media source, change the channel, choose a lighting scene, lower the window shades, lock the doors, arm the security system, or enter a password. Simply say a command and Crestron does the rest.^{1,2}

Streaming Video

Native support for H.265, H.264, and MJPEG formats allows the TS-1070 to display live streaming video from an IP camera, a streaming encoder (Crestron [DM-TXRX-100-STR](#), or similar), or a [DigitalMedia™ switcher](#).³ Video is delivered to the touch screen over Ethernet, eliminating the need for any extra video wiring.

Rava SIP Intercom

[Rava SIP Intercom Technology](#) enables hands-free VoIP communication with other Rava-enabled touch screens and door stations. Rava works over Ethernet, supporting 2-way intercom and paging without requiring any special wiring. VoIP phone capability is also possible through integration with a SIP-compatible IP phone system or SIP server, allowing hands-free telephone functionality complete with speed-dialing, caller ID, custom ringtones, and other enhancements. Built-in echo cancellation affords full-duplex performance for clear, seamless voice communication using the integrated microphone and speakers.²

Sonos App

[Sonos and Crestron](#) have partnered to provide a powerful whole-house music experience. From any touch screen in the house, browse for tracks, artists, or playlists using all the services available from Sonos and instantly play them in any room using Sonos® wireless speakers or a Crestron [Sonnex® multiroom audio system](#). The Sonos app runs natively on the TS-1070, enabling enhanced control of Sonos products as part of a complete Crestron system. The app checks for updates nightly so it's always current, and support for the Sonos S2 App is provided.¹

Crestron Room Scheduling App

As part of a complete enterprise room scheduling solution, the TS-1070 can be deployed as a scheduling panel via the Crestron room scheduling app. A Crestron scheduling panel can be installed at the entrance of a meeting room to provide indication of the room's availability and a view of its schedule for the day. If desired, the room can be reserved on the spot for an ad hoc meeting. A [CEN-ODT-C-POE](#) occupancy sensor can also be paired to the touch screen, allowing for occupancy status to be reported instantly to the scheduling app for no-shows and unscheduled room usage.^{3,4}

Running the Crestron Scheduling App, the TS-1070 integrates directly with [Crestron Fusion®](#) software, Microsoft Exchange Server® software (for users of Outlook® software and Office 365® software), the Google Calendar™ calendaring app (including G Suite™ software), CollegeNET® 25Live® scheduling software, or Ad Astra™ software. IBM® Notes® software is also supported through a Crestron Fusion on-premises server.

Third-Party Scheduling Apps

The TS-1070 also includes support various third-party scheduling applications. New providers are made available via firmware updates. Whatever provider you choose, setup is as simple as connecting the touch screen to the network and choosing an app from the web-based setup menu or built-in setup screens. The selected app downloads from the cloud and installs on the touch screen without any programming or control system required.^{5,6}

Zoom Rooms App

The [Zoom Rooms™](#) conferencing control application enables the TS-1070 to be used as a touch screen control panel for a Zoom Rooms software-based conferencing and collaboration solution. The TS-1070 offers a superior alternative to a consumer tablet device, providing a more reliable and secure platform. The TS-1070 may be configured to run the Zoom Rooms app exclusively, or to allow toggling between the Zoom Rooms app and touch screen control mode. The latter option is used to integrate Zoom Rooms conferencing into a larger AV system while providing touch screen control for both.⁷

NOTE: The Zoom ultrasonic proximity signal is supported up to an average of 9 ft (2.74 m) from the TS-1070 touch screen to an end user device. The range will vary based on environmental noise, the sensitivity of the end user device, and the orientation to the touch screen.

Microsoft Teams App

The [Microsoft Teams®](#) online meeting solution is the hub for teamwork in Office 365® software, engaging people through messaging, voice over IP, online meetings, conferencing, content sharing, and collaboration. The Microsoft Teams application on the TS-1070 enables presentation, calling, conferencing, and collaboration — all through a single touch screen console, with exceptional full-duplex wideband audio and HD video. A consistent user experience in every meeting space is provided via the familiar and intuitive Microsoft Teams UI, affording simple operation, built-in calendaring, and one-touch meeting joins.

NOTE: The TS-1070 must be operated in Microsoft Teams mode in conjunction with a [UC-ENGINE](#) or [UC-BRKT-100-ASSY](#).

Crestron Home OS Control

The TS-1070 may be used to control a [Crestron Home™ OS](#) whole home solution. Select the Crestron Home app from the touch screen to control lighting, shades, climate, media, security, and cameras, including the ability to create and recall scenes that create a desired ambiance throughout a home. A TS-1070 may be installed in each room to provide easy access to various Crestron Home functions for both the room and the home.

Bluetooth Beacon

The built-in Bluetooth® proximity detection beacon enhances the intelligence and personalization of a Crestron system by enabling a smartphone or tablet device to always know what room it is in. It works with the Crestron Go App and Crestron App to determine when the mobile device is in or near the same room as the beacon, and signals the mobile app to automatically display the appropriate controls and information for the room.^{2,8}

Web Browsing

Using its built-in web browser, the TS-1070 provides access to online program guides and other web-based services, and it can be used to control DVRs and other devices without having to pick up a separate tablet or smartphone.¹

Wired and Wi-Fi Connectivity

An Ethernet LAN connection is all that is required to wire the TS-1070, containing all control, video, intercom, and power signals within a single wire.

For deployments without access to Ethernet, the touch screen can also be connected the network over Wi-Fi communications via a local wireless access point (WAP).

Power over Ethernet

Using PoE technology, the TS-1070 gets its operating power directly through the network cable. PoE (Power over Ethernet) eliminates the need for a local power supply or any dedicated power wiring. Crestron PoE switches ([CEN-SW-POE-5](#) or [CEN-SWPOE-16](#)³) offer a total networking solution with built-in PoE for multiple touch screens. A PoE Injector ([PWE-4803RU](#)³) is also available to support a single touch screen.

NOTE: PoE+ is required when connecting a light bar or hallway sign via USB. Refer to the "Power" specifications for more details.

High-Speed USB Port

The TS-1070 provides a high-speed USB 2.0 port for connecting supported Crestron accessories to the touch screen.³

Enterprise-Grade Security

Crestron touch screens employ enterprise-grade networking with robust security features such as 802.1X authentication, TLS encryption, HTTPS connectivity, and Active Directory® service integration. These features are imperative to protect your network against service interruptions and malicious intrusions, and to ensure compliance with your organization's network policies. Cloud-based provisioning and management streamlines the process of configuring, monitoring, and updating every touch screen on the network. Additional support for SNMP allows the touch screen to be monitored by your IT administrator.

XiO Cloud Service

The TS-1070 is compatible with the XiO Cloud® service, which is an IoT (Internet of Things) based platform for remotely provisioning, monitoring, and managing Crestron devices across an enterprise or an entire client base. Built on the Microsoft® Azure® software platform and utilizing Microsoft's industry-leading Azure IoT Hub technology, XiO Cloud enables installers and IT managers to deploy and manage thousands of devices in the time it previously took to manage just one. Unlike other virtual machine-based cloud solutions, Azure services provide unlimited scalability to suit the ever-growing needs of an enterprise. For more information, visit www.crestron.com/xiocloud.

Crestron ONE App Support

The TS-1070 is compatible with the [Crestron ONE™ mobile room control app](#). The Crestron ONE app creates a peer-to-peer network over Bluetooth communications between a mobile device and the TS-1070 in the room, allowing mobile-optimized room controls to be pushed to the device from the touch screen. Programmers can specify the controls that display on the mobile app by mapping joins from Smart Graphics projects to the mobile project. A [SW-MOBILITY](#) license is required to enable mobile room control functionality.

Optional Mounting Accessories

The [TS-770/1070-SMK](#) allows the touch screen to be mounted permanently to a tabletop and permits up to 330 degree swivel rotation.

Notes:

1. Voice recognition, web browsing, weather information, and certain other functions require an internet connection.
2. The microphone and Bluetooth® transceiver may be defeated programmatically at any time.
3. Item(s) sold separately. Refer to each product's spec sheet for complete information.
4. Room scheduling mode requires the TS-1070 to be designated exclusively for room scheduling use, which precludes use of certain features and functions described in this spec sheet. Additionally, CollegeNET® 25Live® scheduling software and Ad Astra™ software do not support scheduling ad hoc meetings from the touch screen. For design assistance, contact the Crestron True Blue support team at www.crestron.com/support.
5. Refer to the firmware release notes for a list of all scheduling apps that are supported by that firmware release.
6. Additional subscriptions and/or licenses may be required. Refer to each provider's website for details about the capabilities and requirements of its scheduling application and services. Third-party apps typically run on the TS-1070 as they do on a tablet device. The TS-1070 runs only one app, which is selected at setup. Only the apps approved and delivered by Crestron can run on the TS-1070.
7. A complete Zoom Rooms solution requires a mini PC or Mac computer running Zoom software, a Zoom Rooms subscription, plus additional peripherals and cables. Visit zoom.us/zoomrooms for more information about Zoom Rooms capabilities, hardware requirements, and subscription plans. For design assistance, contact the Crestron True Blue support team at www.crestron.com/support.
8. The TS-1070 provides an integrated, equivalent alternative to the standalone [PP-100-W](#) beacon. For more details, refer to the PP-100-W spec sheet. Bluetooth technology is used solely for proximity detection and does not transmit or receive any control, multimedia, or personal data. Crestron Bluetooth beacons are only visible to Bluetooth enabled devices that are specifically programmed and configured to work with them.

TS-1070-GV Features

The Crestron® TS-1070-GV is a stylish and versatile tabletop touch screen that is ideal for residential and enterprise applications. The TS-1070-GV features a 10.1 in. (257 mm) capacitive touch screen display with custom-programmable control buttons and support for Smart Graphics® software and HTML5-based custom UI projects. PoE connectivity and a modern tabletop design allow the touch screen to be deployed just about anywhere.

NOTE: The TS-1070-GV series is a modified version of the TS-1070 series, which eliminates the microphone, the Bluetooth® communications beacon, and Wi-Fi® network connectivity to comply with government applications demanding extra privacy and security.



Key features include:

- Next generation Crestron® tabletop touch screen
- 10.1 in. (257 mm) widescreen active-matrix color display and 1920 x 1200 WUXGA display resolution
- Capacitive touch screen display
- Custom-programmable virtual control buttons
- Supports Crestron HTML5 and Smart Graphics® software custom user projects

- Built-in speakers
- H.265, H.264, or MJPEG streaming video display
- Built-in web browsing
- Single wire Ethernet connection with PoE or PoE+ power
- USB 2.0 port
- Enterprise grade security and authentication
- Web or device-based configuration

Advanced Touch Screen Control

The TS-1070-GV offers a sleek and powerful user interface for controlling technology in a home, boardroom, classroom, or command center. The touch screen provides an intuitive interface that is fully customizable with easy-to-use capacitive controls, true feedback, and real-time status display. A built-in proximity sensor wakes the screen without requiring any user interaction, and automatic brightness controls ensure optimal visibility under varying lighting conditions.

Custom-Programmable Virtual Buttons

The TS-1070-GV provides a universal status bar that is populated with virtual buttons for quick access to common touch screen functions. The touch screen comes preconfigured with virtual buttons for Power, Home, Lights, Up, and Down. Each button can be programmed via a Crestron control system to provide custom functionality, and unused buttons can be hidden individually. The universal status bar is expanded or hidden using simple swipe gestures on touch screen display.

Dynamic User Interfaces

The TS-1070-GV supports custom user interfaces created with [Crestron HTML5 User Interface](#) and Smart Graphics technologies, allowing greater flexibility for UI developers and programmers.

- Crestron HTML5 User Interface enables UI designers to develop rich, front-end user interfaces with increased reusability and efficiency using modern web methodologies. Crestron HTML5 User Interface development tools are provided to simplify creating user interfaces built on standard web technologies
- Smart Graphics enables programmers to integrate fluid gesture-driven controls, animated feedback, rich metadata, embedded apps and widgets, and full-motion video into their user interfaces. Smart Graphics provides dynamic features such as graphical buttons and sliders, lists and toolbars, drag-and-drop objects, dashboard widgets, screensavers, and customizable themes.¹

Streaming Video

Native support for H.265, H.264, and MJPEG formats allows the TS-1070-GV to display live streaming video from an IP camera, a streaming encoder (Crestron [DM-TXRX-100-STR](#), or similar), or a [DigitalMedia™ switcher](#).² Video is delivered to the touch screen over Ethernet, eliminating the need for any extra video wiring.

Sonos App

[Sonos and Crestron](#) have partnered to provide a powerful whole-house music experience. From any touch screen in the house, browse for tracks, artists, or playlists using all the services available from Sonos and instantly play them in any room using Sonos® wireless speakers or a Crestron [Sonnex® multiroom audio system](#). The Sonos app runs natively on the TS-1070-GV, enabling enhanced control of Sonos products as part of a complete Crestron system. The app checks for updates nightly so it's always current, and support for the Sonos S2 App is provided.¹

Crestron Room Scheduling App

As part of a complete enterprise room scheduling solution, the TS-1070-GV can be deployed as a scheduling panel via the Crestron room scheduling app. A Crestron scheduling panel can be installed at the entrance of a meeting room to provide indication of the room's availability and a view of its schedule for the day. If desired, the room can be reserved on the spot for an ad hoc meeting. A [CEN-ODT-C-POE](#) occupancy sensor can also be paired to the touch screen, allowing for occupancy status to be reported instantly to the scheduling app for no-shows and unscheduled room usage.^{2,3}

Running the Crestron Scheduling App, the TS-1070-GV integrates directly with [Crestron Fusion®](#) software, Microsoft Exchange Server® software (for users of Outlook® software and Office 365® software), the Google Calendar™ calendaring app (including G Suite™ software), CollegeNET® 25Live® scheduling software, or Ad Astra™ software. IBM® Notes® software is also supported through a Crestron Fusion on-premises server.

Third-Party Scheduling Apps

The TS-1070-GV also includes support various third-party scheduling applications. New providers are made available via firmware updates. Whatever provider you choose, setup is as simple as connecting the touch screen to the network and choosing an app from the web-based setup menu or built-in setup screens. The selected app downloads from the cloud and installs on the touch screen without any programming or control system required.^{4,5}

Zoom Rooms App

The [Zoom Rooms™](#) conferencing control application enables the TS-1070-GV to be used as a touch screen control panel for a Zoom Rooms software-based conferencing and collaboration solution. The TS-1070-GV offers a superior alternative to a consumer tablet device, providing a more reliable and secure platform. The TS-1070-GV may be configured to run the Zoom Rooms app exclusively, or to allow toggling between the Zoom Rooms app and touch screen control mode. The latter option is used to integrate Zoom Rooms conferencing into a larger AV system while providing touch screen control for both.⁶

NOTE: The Zoom ultrasonic proximity signal is supported up to an average of 9 ft (2.74 m) from the TS-1070-GV touch screen to an end user device. The range will vary based on environmental noise, the sensitivity of the end user device, and the orientation to the touch screen.

Microsoft Teams App

The [Microsoft Teams](#)® online meeting solution is the hub for teamwork in Office 365® software, engaging people through messaging, voice over IP, online meetings, conferencing, content sharing, and collaboration. The Microsoft Teams application on the TS-1070-GV enables presentation, calling, conferencing, and collaboration — all through a single touch screen console, with exceptional full-duplex wideband audio and HD video. A consistent user experience in every meeting space is provided via the familiar and intuitive Microsoft Teams UI, affording simple operation, built-in calendaring, and one-touch meeting joins.

NOTE: The TS-1070-GV must be operated in Microsoft Teams mode in conjunction with a [UC-ENGINE](#) or [UC-BRKT-100-ASSY](#).

Crestron Home OS Control

The TS-1070-GV may be used to control a [Crestron Home™ OS](#) whole home solution. Select the Crestron Home app from the touch screen to control lighting, shades, climate, media, security, and cameras, including the ability to create and recall scenes that create a desired ambiance throughout a home. A TS-1070-GV may be installed in each room to provide easy access to various Crestron Home functions for both the room and the home.

Web Browsing

Using its built-in web browser, the TS-1070-GV provides access to online program guides and other web-based services, and it can be used to control DVRs and other devices without having to pick up a separate tablet or smartphone.¹

Wired Connectivity

An Ethernet LAN connection is all that is required to wire the TS-1070-GV, containing all control, video, intercom, and power signals within a single wire.

Power over Ethernet

Using PoE technology, the TS-1070-GV gets its operating power directly through the network cable. PoE (Power over Ethernet) eliminates the need for a local power supply or any dedicated power wiring. Crestron PoE switches ([CEN-SW-POE-5](#) or [CEN-SWPOE-16](#)) offer a total networking solution with built-in PoE for multiple touch screens. A PoE Injector ([PWE-4803RU](#)) is also available to support a single touch screen.

NOTE: Refer to the “Power” specifications for more details.

High-Speed USB Port

The TS-1070-GV provides a high-speed USB 2.0 port for connecting supported Crestron accessories to the touch screen.²

Enterprise-Grade Security

Crestron touch screens employ enterprise-grade networking with robust security features such as 802.1X authentication, TLS encryption, HTTPS connectivity, and Active Directory® service integration. These features are imperative to protect your network against service interruptions and malicious intrusions, and to ensure compliance with your organization's network policies. Cloud-based provisioning and management streamlines the process of configuring, monitoring, and updating every touch screen on the network. Additional support for SNMP allows the touch screen to be monitored by your IT administrator.

Optional Mounting Accessories

The [TS-770/1070-SMK](#) allows the touch screen to be mounted permanently to a tabletop and permits up to 330 degree swivel rotation.

Notes:

1. Web browsing, weather information, and certain other functions require an internet connection.
2. Item(s) sold separately. Refer to each product's spec sheet for complete information.
3. Room scheduling mode requires the TS-1070-GV to be designated exclusively for room scheduling use, which precludes use of certain features and functions described in this spec sheet. Additionally, CollegeNET® 25Live® scheduling software and Ad Astra™ software do not support scheduling ad hoc meetings from the touch screen. For design assistance, contact the Crestron True Blue support team at www.crestron.com/support.
4. Refer to the firmware release notes for a list of all scheduling apps that are supported by that firmware release.
5. Additional subscriptions and/or licenses may be required. Refer to each provider's website for details about the capabilities and requirements of its scheduling application and services. Third-party apps typically run on the TS-1070-GV as they do on a tablet device. The TS-1070-GV runs only one app, which is selected at setup. Only the apps approved and delivered by Crestron can run on the TS-1070-GV.
6. A complete Zoom Rooms solution requires a mini PC or Mac computer running Zoom software, a Zoom Rooms subscription, plus additional peripherals and cables. Visit zoom.us/zoomrooms for more information about Zoom Rooms capabilities, hardware requirements, and subscription plans. For design assistance, contact the Crestron True Blue support team at www.crestron.com/support.

TS-1070R Features

The Crestron® TS-1070R is a stylish and versatile tabletop touch screen that is designed specifically to run the Crestron Home™ OS application. The TS-1070R features a 10.1 in. (257 mm) capacitive touch screen display. PoE and Wi-Fi® network connectivity and a modern tabletop design allow the touch screen to be deployed just about anywhere.



Key features include:

- Next generation Crestron® tabletop touch screen featuring a native Crestron Home™ OS application
- 10.1 in. (257 mm) widescreen active-matrix color display and 1920 x 1200 WUXGA display resolution
- Capacitive touch screen display
- Built-in Rava® SIP intercom
- Built-in speakers and microphone
- H.265, H.264, or MJPEG streaming video display
- Single wire Ethernet connection with PoE or PoE+ power
- Wi-Fi® network connectivity
- USB 2.0 port

- Enterprise grade security and authentication
- Web or device-based configuration

Advanced Touch Screen Control

The TS-1070R offers a sleek and powerful user interface for controlling technology in the home via the Crestron Home app. The touch screen provides an intuitive interface that is fully customizable with easy-to-use capacitive controls, true feedback, and real-time status display. A built-in proximity sensor wakes the screen without requiring any user interaction, and automatic brightness controls ensure optimal visibility under varying lighting conditions.

Streaming Video

Native support for H.265, H.264, and MJPEG formats allows the TS-1070R to display live streaming video from an IP camera, a streaming encoder (Crestron [DM-TXRX-100-STR](#), or similar), or a [DigitalMedia™ switcher](#).³ Video is delivered to the touch screen over Ethernet, eliminating the need for any extra video wiring.

Rava SIP Intercom

[Rava SIP Intercom Technology](#) enables hands-free VoIP communication with other Rava-enabled touch screens and door stations. Rava works over Ethernet, supporting 2-way intercom and paging without requiring any special wiring. VoIP phone capability is also possible through integration with a SIP-compatible IP phone system or SIP server, allowing hands-free telephone functionality complete with speed-dialing, caller ID, custom ringers, and other enhancements. Built-in echo cancellation affords full-duplex performance for clear, seamless voice communication using the integrated microphone and speakers.²

Sonos App

[Sonos and Crestron](#) have partnered to provide a powerful whole-house music experience. From any touch screen in the house, browse for tracks, artists, or playlists using all the services available from Sonos and instantly play them in any room using Sonos® wireless speakers or a Crestron [Sonnex® multiroom audio system](#). The Sonos app runs natively on the TS-1070R, enabling enhanced control of Sonos products as part of a complete Crestron system. The app checks for updates nightly so it's always current, and support for the Sonos S2 App is provided.¹

Crestron Home OS Control

The TS-1070R may be used to control a [Crestron Home™ OS](#) whole home solution. Select the Crestron Home app from the touch screen to control lighting, shades, climate, media, security, and cameras, including the ability to create and recall scenes that create a desired ambiance throughout a home. A TS-1070R may be installed in each room to provide easy access to various Crestron Home functions for both the room and the home.

Wired and Wi-Fi Connectivity

An Ethernet LAN connection is all that is required to wire the TS-1070R, containing all control, video, intercom, and power signals within a single wire.

For deployments without access to Ethernet, the touch screen can also be connected the network over Wi-Fi communications via a local wireless access point (WAP).

Power over Ethernet

Using PoE technology, the TS-1070R gets its operating power directly through the network cable. PoE (Power over Ethernet) eliminates the need for a local power supply or any dedicated power wiring. Crestron PoE switches ([CEN-SW-POE-5](#) or [CEN-SWPOE-16³](#)) offer a total networking solution with built-in PoE for multiple touch screens. A PoE Injector ([PWE-4803RU³](#)) is also available to support a single touch screen.

NOTE: Refer to the “Power” specifications for more details.

Enterprise-Grade Security

Crestron touch screens employ enterprise-grade networking with robust security features such as 802.1X authentication, TLS encryption, HTTPS connectivity, and Active Directory® service integration.

Optional Mounting Accessories

The [TS-770/1070-SMK](#) allows the touch screen to be mounted permanently to a tabletop and permits up to 330 degree swivel rotation.

Notes:

1. Certain other functions require an internet connection.
2. The microphone may be defeated programmatically at any time.
3. Item(s) sold separately. Refer to each product's spec sheet for complete information.

Physical Description

The TS-70 Series provides the following connectors and indicators.

TS-770 and TS-1070 Series Connectors

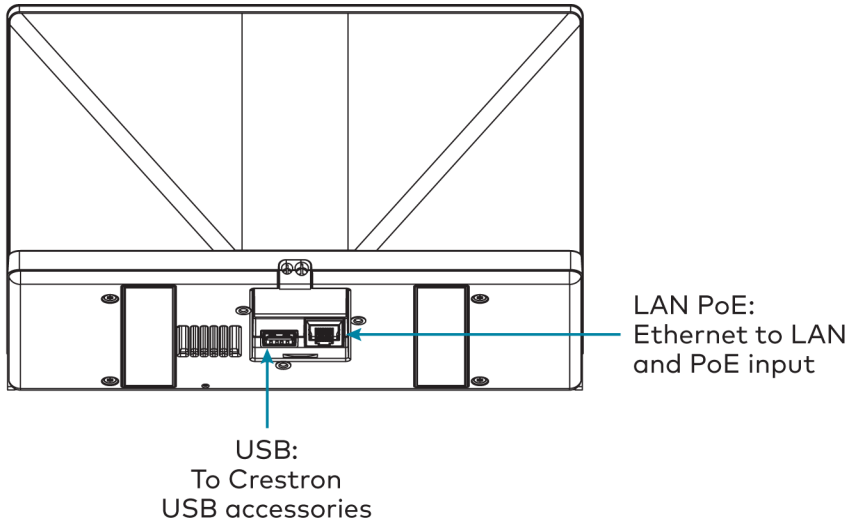

Connectors and Indicators

LAN PoE	(1) 8-pin RJ-45 connector, female, with 2 LED indicators; 100BASE-TX Ethernet port; PoE+ PD port; Green and yellow LEDs indicate Ethernet port status
USB	(1) USB Type-A connector, female; USB 2.0 host port

Specifications

Refer to the following sections for more information on the specifications for various TS-70 Series models.

- [TS-770 Specifications on page 32](#)
- [TS-770-GV Specifications on page 38](#)
- [TS-770R Specifications on page 43](#)
- [TS-1070 Specifications on page 47](#)
- [TS-1070-GV Specifications on page 53](#)
- [TS-1070R Specifications on page 58](#)

TS-770 Specifications

Product specifications for the TS-770 are provided below.

Product Specifications

Touch Screen Display

Display Type	TFT active matrix color LCD
Size	7 in. (178 mm) diagonal
Aspect Ratio	16:10 WXGA
Resolution	1280 x 800 pixels
Brightness	350 nits (cd/m ²)
Contrast	850:1
Color Depth	24 bit, 16.7M colors
Illumination	Edgelit LED with auto brightness control
Viewing Angle	±80° horizontal, ±80° vertical
Touch Screen	Projected capacitive, 5-point multitouch capable

Buttons

Virtual Buttons	(6) Virtual buttons in collapsible universal tool bar, per-button show/hide, preconfigured with icons for Power, Home, Lights, Up, Down, and Microphone, optional custom programming via control system for additional functions
Reset	(1) Pin hole on bottom for hardware reset

Graphics Engine

Crestron HTML5 and Smart Graphics® software technology, multilanguage web browser¹, multilanguage on-screen keyboard, screensaver, single scalable streaming video window, native room scheduling applications^{4,5,6}, native Sonos® app¹, native Zoom Rooms™ app⁷, native Crestron Home™ OS app, setup and diagnostics via web browser, cloud, or on-screen UI

Room Scheduling Support

Crestron Scheduling App	Crestron Fusion® software, Microsoft Exchange Server® and Office 365® software, Google Calendar™ calendaring app and G Suite™ software, CollegeNET® 25Live® software, and Ad Astra™ software (IBM® Notes® software is also supported through Crestron Fusion on-premises server only) ⁴
Third-Party Apps	Includes support for various third-party scheduling applications. ^{5,6}

Languages

Smart Graphics	Arabic, Chinese (Simplified), Chinese (Traditional), Czech, Danish, Dutch, English (UK), English (US), Finnish, French, German, Greek, Hebrew, Hungarian, Italian, Japanese, Korean, Norwegian, Polish, Portuguese, Portuguese (Brazilian), Romanian, Russian, Slovak, Spanish, Swedish, Thai
On-screen Keyboard	Arabic, Chinese (Simplified), Croatian, Czech, Danish, Dutch, English (UK), English (US), Finnish, French (Canada), French (Switzerland), German, Hebrew, Hungarian, Italian, Japanese, Norwegian Bokmal, Polish, Portuguese, Russian, Serbian, Spanish, Swedish, Turkish
Voice Recognition¹	Afrikaans (South Africa); Chinese, Mandarin (China, Simplified); Chinese, Mandarin (Hong Kong, Simplified); Chinese, Mandarin (Taiwan, Traditional); Chinese, Yue (Hong Kong, Traditional); Czech (Czech Republic); Dutch (Netherlands); English (Australia); English (Canada); English (Generic); English (India); English (New Zealand); English (South Africa); English (UK); English (US); French (France); German (Germany); isiZulu (South Africa); Italian (Italy); Japanese (Japan); Korean (South Korea); Polish (Poland); Portuguese (Brazil); Russian (Russia); Spanish (Spain); Turkish (Turkey)
Web Browser¹	Arabic, Bulgarian, Catalan, Chinese, Croatian, Czech, Danish, Dutch, English, Filipino, Finnish, French, German, Greek, Hebrew, Hindi, Hungarian, Indonesian, Italian, Japanese, Korean, Latvian, Lithuanian, Norwegian Bokmal, Pashto, Persian, Polish, Portuguese, Romanian, Romansh, Russian, Serbian, Slovak, Slovenian, Spanish, Swedish, Thai, Turkish, Ukrainian, Vietnamese
Room Scheduling⁴	Chinese (Simplified), Chinese (Traditional), Danish, Dutch (Netherlands), English (US), English (UK), French, German, Hebrew, Italian, Japanese, Korean, Norwegian, Portuguese (Brazil), Portuguese (Portugal), Russian, Spanish, Swedish

Memory

RAM	2 GB LPDDR3
Storage	Firmware/Application: 16 GB eMMC pSLC
Maximum Project Size	600 MB

Wired Communications

Ethernet	100 Mbps, auto switching, auto negotiating, auto discovery, full/half duplex, TCP/IP, UDP/IP, CIP, DHCP, SSL, TLS, SSH, SFTP (SSH File Transfer Protocol), IEEE 802.1X, SNMP, IPv4 or IPv6, Active Directory® service authentication, HTTPS web browser setup, XiO Cloud® client, IEEE 802.3at compliant
-----------------	--

Wireless Communications

Transceiver	IEEE 802.11a/b/g/n/ac Wi-Fi (2.4 or 5 GHz 2-way RF), static IP or dynamic IP via DHCP
Security	64 and 128-bit WEP, WPA and WPA2-PSK with TKIP and AES
Range	Up to 50 ft (15 m), subject to site-specific conditions
Bluetooth® Hardware	Crestron Bluetooth beacon ^{2,8}

Streaming Decoder

Video Formats	H.265, H.264 (MPEG-4 part 10 AVC, MJPEG)
Audio Formats	AAC Stereo
Bitrates	Up to 25 Mbps (20 Mbps maximum recommended)
Input Resolutions	Up to 1920x1080@30fps
Protocol	RTSP

Audio

Features	Built-in microphone and speakers, Rava® SIP Intercom, voice recognition ^{1,2}
Audio Feedback Formats	MP3

Connectors

LAN PoE	(1) 8-pin RJ-45 connector, female, with 2 LED indicators; 100BASE-TX Ethernet port; PoE+ PD port; Green and yellow LEDs indicate Ethernet port status
USB	(1) USB Type-A connector, female; USB 2.0 host port

Power

PoE (Power over Ethernet)	IEEE 802.3at Type 2 compliant PoE+ PD (Powered Device); Requests 15 W from an 802.3at Type 2 PSE with LLDP advanced power management; Requests 30 W (PoE+ Class 4) from an 802.3at Type 2 PSE without LLDP; Requests 15.4 W (PoE Class 0) from an 802.3af (or 802.3at Type 1) PSE
----------------------------------	--

Environmental

Temperature	32 to 104°F (0 to 40°C)
Humidity	10% to 95% RH (noncondensing)
Heat Dissipation	44 BTU/hr

Construction

Housing	Plastic, smooth black or white finish, edge-to-edge glass with black or white surround
----------------	--

Dimensions

Height	4.02 in. (102 mm)
Width	6.87 in. (175 mm)
Depth	4.37 in. (111 mm)

Weight

1.33 lb (605 g)

Compliance

Regulatory Model: M201923005
IC, CE, FCC Part 15 Class B digital device

Dimension Drawings

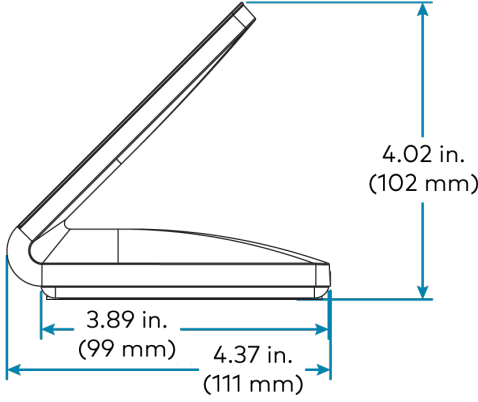
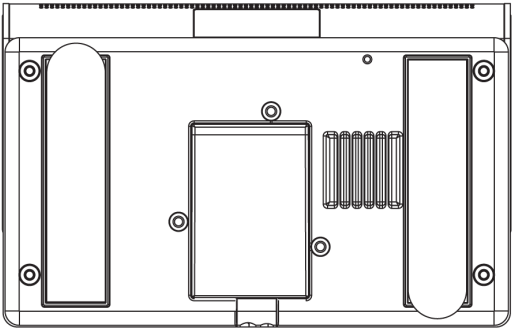
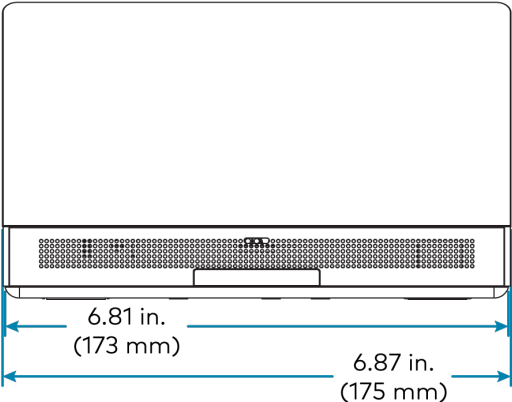
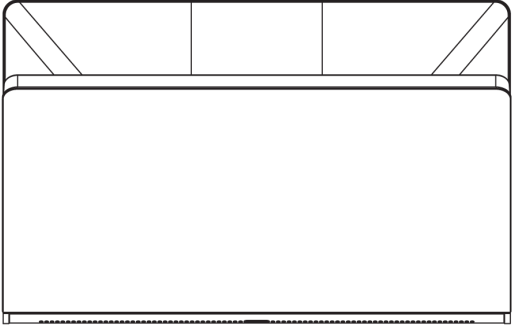

Notes:

1. Voice recognition, web browsing, weather information, and certain other functions require an internet connection.
2. The microphone and Bluetooth® transceiver may be defeated programmatically at any time.
3. Item(s) sold separately. Refer to each product's spec sheet for complete information.
4. Room scheduling mode requires the TS-770 to be designated exclusively for room scheduling use, which precludes use of certain features and functions described in this spec sheet. Additionally, CollegeNET® 25Live® scheduling software and Ad Astra™ software do not support scheduling ad hoc meetings from the touch screen. For design assistance, contact the Crestron True Blue support team at www.crestron.com/support.
5. Refer to the firmware release notes for a list of all scheduling apps that are supported by that firmware release.
6. Additional subscriptions and/or licenses may be required. Refer to each provider's website for details about the capabilities and requirements of its scheduling application and services. Third-party apps typically run on the TS-770 as they do on a tablet device. The TS-770 runs only one app, which is selected at setup. Only the apps approved and delivered by Crestron can run on the TS-770.
7. A complete Zoom Rooms solution requires a mini PC or Mac computer running Zoom software, a Zoom Rooms subscription, plus additional peripherals and cables. Visit zoom.us/zoomrooms for more information about Zoom Rooms capabilities, hardware requirements, and subscription plans. For design assistance, contact the Crestron True Blue support team at www.crestron.com/support.
8. The TS-770 provides an integrated, equivalent alternative to the standalone [PP-100-W](#) beacon. For more details, refer to the PP-100-W spec sheet. Bluetooth technology is used solely for proximity detection and does not transmit or receive any control, multimedia, or personal data. Crestron Bluetooth beacons are only visible to Bluetooth enabled devices that are specifically programmed and configured to work with them.

TS-770-GV Specifications

Product specifications for the TS-770-GV are provided below.

Product Specifications

Touch Screen Display

Display Type	TFT active matrix color LCD
Size	7 in. (178 mm) diagonal
Aspect Ratio	16:10 WXGA
Resolution	1280 x 800 pixels
Brightness	350 nits (cd/m ²)
Contrast	850:1
Color Depth	24 bit, 16.7M colors
Illumination	Edgelit LED with auto brightness control
Viewing Angle	±80° horizontal, ±80° vertical
Touch Screen	Projected capacitive, 5-point multitouch capable

Buttons

Virtual Buttons	(5) Virtual buttons in collapsible universal tool bar, per-button show/hide, preconfigured with icons for Power, Home, Lights, Up, and Down, optional custom programming via control system for additional functions
Reset	(1) Pin hole on bottom for hardware reset

Graphics Engine

Crestron HTML5 and Smart Graphics® software technology, multilanguage web browser¹, multilanguage on-screen keyboard, screensaver, single scalable streaming video window, native room scheduling applications^{3,4,5}, native Sonos® app¹, native Zoom Rooms™ app⁶, native Crestron Home™ OS app, setup and diagnostics via web browser, cloud, or on-screen UI

Room Scheduling Support

Crestron Scheduling App	Crestron Fusion® software, Microsoft Exchange Server® and Office 365® software, Google Calendar™ calendaring app and G Suite™ software, CollegeNET® 25Live® software, and Ad Astra™ software (IBM® Notes® software is also supported through Crestron Fusion on-premises server only) ³
Third-Party Apps	Includes support for various third-party scheduling applications. ^{4,5}

Languages

Smart Graphics	Arabic, Chinese (Simplified), Chinese (Traditional), Czech, Danish, Dutch, English (UK), English (US), Finnish, French, German, Greek, Hebrew, Hungarian, Italian, Japanese, Korean, Norwegian, Polish, Portuguese, Portuguese (Brazilian), Romanian, Russian, Slovak, Spanish, Swedish, Thai
On-screen Keyboard	Arabic, Chinese (Simplified), Croatian, Czech, Danish, Dutch, English (UK), English (US), Finnish, French (Canada), French (Switzerland), German, Hebrew, Hungarian, Italian, Japanese, Norwegian Bokmal, Polish, Portuguese, Russian, Serbian, Spanish, Swedish, Turkish
Web Browser¹	Arabic, Bulgarian, Catalan, Chinese, Croatian, Czech, Danish, Dutch, English, Filipino, Finnish, French, German, Greek, Hebrew, Hindi, Hungarian, Indonesian, Italian, Japanese, Korean, Latvian, Lithuanian, Norwegian Bokmal, Pashto, Persian, Polish, Portuguese, Romanian, Romansh, Russian, Serbian, Slovak, Slovenian, Spanish, Swedish, Thai, Turkish, Ukrainian, Vietnamese
Room Scheduling³	Chinese (Simplified), Chinese (Traditional), Danish, Dutch (Netherlands), English (US), English (UK), French, German, Hebrew, Italian, Japanese, Korean, Norwegian, Portuguese (Brazil), Portuguese (Portugal), Russian, Spanish, Swedish

Memory

RAM	2 GB LPDDR3
Storage	Firmware/Application: 16 GB eMMC pSLC
Maximum Project Size	600 MB

Wired Communications

Ethernet	100 Mbps, auto switching, auto negotiating, auto discovery, full/half duplex, TCP/IP, UDP/IP, CIP, DHCP, SSL, TLS, SSH, SFTP (SSH File Transfer Protocol), IEEE 802.1X, SNMP, IPv4 or IPv6, Active Directory [®] service authentication, HTTPS web browser setup, IEEE 802.3at compliant
USB	USB 2.0 host

Streaming Decoder

Video Formats	H.265, H.264 (MPEG-4 part 10 AVC, MJPEG)
Audio Formats	AAC Stereo
Bitrates	Up to 25 Mbps (20 Mbps maximum recommended)
Input Resolutions	Up to 1920x1080@30fps
Protocol	RTSP

Audio

Features	Built-in speakers
Audio Feedback Formats	MP3

Connectors

LAN PoE	(1) 8-pin RJ-45 connector, female, with 2 LED indicators; 100BASE-TX Ethernet port; PoE+ PD port; Green and yellow LEDs indicate Ethernet port status
USB	(1) USB Type-A connector, female; USB 2.0 host port

Power

PoE (Power over Ethernet)	IEEE 802.3at Type 2 compliant PoE+ PD (Powered Device); Requests 15 W from an 802.3at Type 2 PSE with LLDP advanced power management; Requests 30 W (PoE+ Class 4) from an 802.3at Type 2 PSE without LLDP; Requests 15.4 W (PoE Class 0) from an 802.3af (or 802.3at Type 1) PSE
----------------------------------	--

Environmental

Temperature	32 to 104°F (0 to 40°C)
Humidity	10% to 95% RH (noncondensing)
Heat Dissipation	44 BTU/hr

Construction

Housing	Plastic, smooth black or white finish, edge-to-edge glass with black or white surround
----------------	--

Dimensions

Height	4.02 in. (102 mm)
Width	6.87 in. (175 mm)
Depth	4.37 in. (111 mm)

Weight

1.33 lb (605 g)

Compliance

Regulatory Model: M201923005

IC, CE, FCC Part 15 Class B digital device

Dimension Drawings

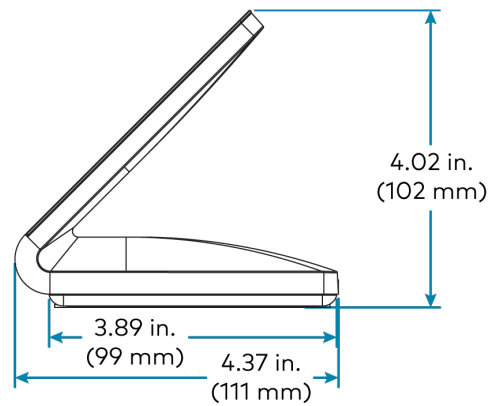
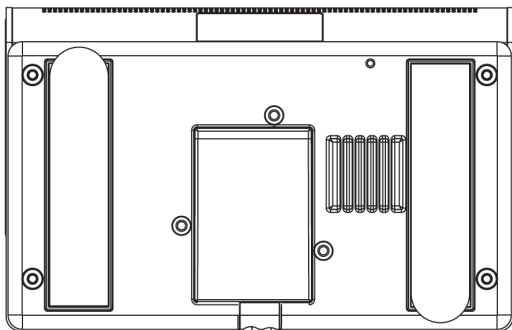
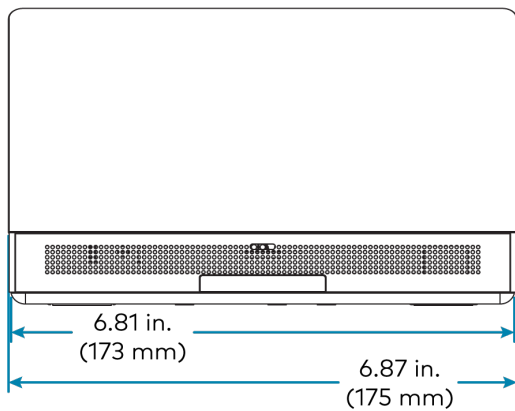
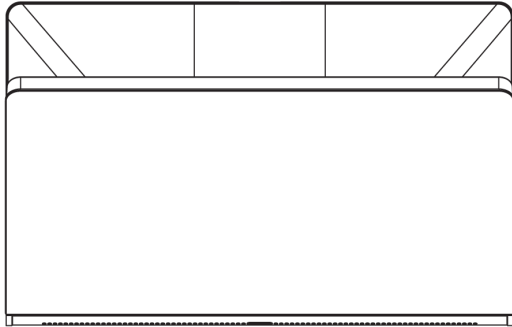

Notes:

1. Web browsing, weather information, and certain other functions require an internet connection.
2. Item(s) sold separately. Refer to each product's spec sheet for complete information.
3. Room scheduling mode requires the TS-770-GV to be designated exclusively for room scheduling use, which precludes use of certain features and functions described in this spec sheet. Additionally, CollegeNET® 25Live® scheduling software and Ad Astra™ software do not support scheduling ad hoc meetings from the touch screen. For design assistance, contact the Crestron True Blue support team at www.crestron.com/support.
4. Refer to the firmware release notes for a list of all scheduling apps that are supported by that firmware release.
5. Additional subscriptions and/or licenses may be required. Refer to each provider's website for details about the capabilities and requirements of its scheduling application and services. Third-party apps typically run on the TS-770-GV as they do on a tablet device. The TS-770-GV runs only one app, which is selected at setup. Only the apps approved and delivered by Crestron can run on the TS-770-GV.
6. A complete Zoom Rooms solution requires a mini PC or Mac computer running Zoom software, a Zoom Rooms subscription, plus additional peripherals and cables. Visit zoom.us/zoomrooms for more information about Zoom Rooms capabilities, hardware requirements, and subscription plans. For design assistance, contact the Crestron True Blue support team at www.crestron.com/support.

TS-770R Specifications

Product specifications for the TS-770R are provided below.

Product Specifications

Touch Screen Display

Display Type	TFT active matrix color LCD
Size	7 in. (178 mm) diagonal
Aspect Ratio	16:10 WXGA
Resolution	1280 x 800 pixels
Brightness	350 nits (cd/m ²)
Contrast	850:1
Color Depth	24 bit, 16.7M colors
Illumination	Edgelit LED with auto brightness control
Viewing Angle	±80° horizontal, ±80° vertical
Touch Screen	Projected capacitive, 5-point multitouch capable

Buttons

Virtual Buttons	(6) Virtual buttons in collapsible universal tool bar, per-button show/hide, preconfigured with icons for Power, Home, Lights, Up, Down, and Microphone
Reset	(1) Pin hole on bottom for hardware reset

Graphics Engine

Native Sonos® app¹, native Crestron Home™ OS app, touch screen setup and diagnostics via web browser or on-screen UI, Crestron Home setup and diagnostics via Crestron Home Setup app

Languages

On-screen Keyboard	Arabic, Chinese (Simplified), Croatian, Czech, Danish, Dutch, English (UK), English (US), Finnish, French (Canada), French (Switzerland), German, Hebrew, Hungarian, Italian, Japanese, Norwegian Bokmal, Polish, Portuguese, Russian, Serbian, Spanish, Swedish, Turkish
---------------------------	---

Memory

RAM	2 GB LPDDR3
Storage	Firmware/Application: 16 GB eMMC pSLC

Wired Communications

Ethernet	100 Mbps, auto switching, auto negotiating, auto discovery, full/half duplex, TCP/IP, UDP/IP, CIP, DHCP, SSL, TLS, SSH, SFTP (SSH File Transfer Protocol), IEEE 802.1X, SNMP, IPv4 or IPv6, Active Directory® service authentication, HTTPS web browser setup, IEEE 802.3at compliant
USB	USB 2.0 host

Wireless Communications

Transceiver	IEEE 802.11a/b/g/n/ac Wi-Fi (2.4 or 5 GHz 2-way RF), static IP or dynamic IP via DHCP
Security	64 and 128-bit WEP, WPA and WPA2-PSK with TKIP and AES
Range	Up to 50 ft (15 m), subject to site-specific conditions

Streaming Decoder

Video Formats	H.265, H.264 (MPEG-4 part 10 AVC, MJPEG)
Audio Formats	AAC Stereo
Bitrates	Up to 25 Mbps (20 Mbps maximum recommended)
Input Resolutions	Up to 1920x1080@30fps
Protocol	RTSP

Audio

Features	Built-in microphone and speakers, Rava® SIP Intercom ^{1,2}
Audio Feedback Formats	MP3

Connectors

LAN PoE	(1) 8-pin RJ-45 connector, female, with 2 LED indicators; 100BASE-TX Ethernet port; PoE+ PD port; Green and yellow LEDs indicate Ethernet port status
USB	(1) USB Type-A connector, female; USB 2.0 host port

Power

PoE (Power over Ethernet)	IEEE 802.3at Type 2 compliant PoE+ PD (Powered Device); Requests 15 W from an 802.3at Type 2 PSE with LLDP advanced power management; Requests 30 W (PoE+ Class 4) from an 802.3at Type 2 PSE without LLDP; Requests 15.4 W (PoE Class 0) from an 802.3af (or 802.3at Type 1) PSE
----------------------------------	--

Environmental

Temperature	32 to 104°F (0 to 40°C)
Humidity	10% to 95% RH (noncondensing)
Heat Dissipation	44 BTU/hr

Construction

Housing	Plastic, smooth black or white finish, edge-to-edge glass with black or white surround
----------------	--

Dimensions

Height	4.02 in. (102 mm)
Width	6.87 in. (175 mm)
Depth	4.37 in. (111 mm)

Weight

1.33 lb (605 g)

Compliance

Regulatory Model: M201923005
IC, CE, FCC Part 15 Class B digital device

Dimension Drawings

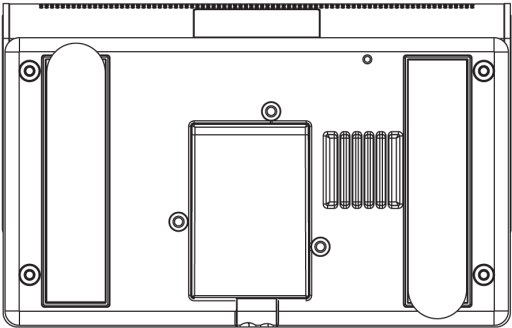
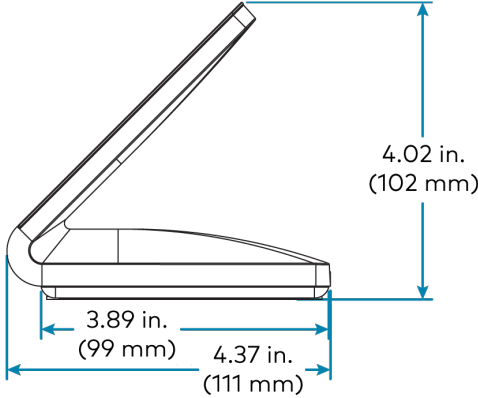
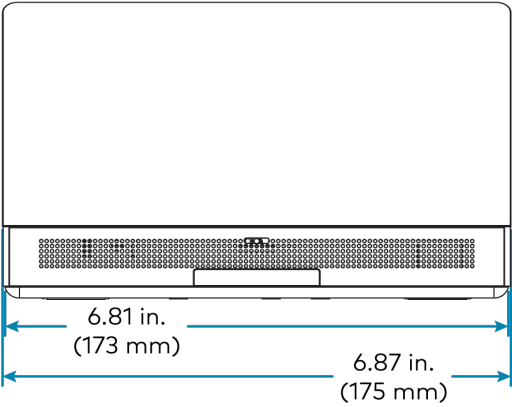
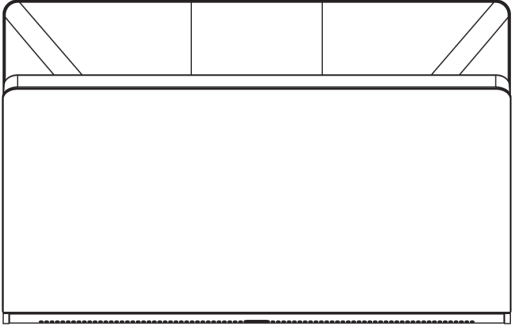

Notes:

- 1. Certain other functions require an internet connection.
- 2. The microphone may be defeated programmatically at any time.
- 3. Item(s) sold separately. Refer to each product's spec sheet for complete information.

TS-1070 Specifications

Product specifications for the TS-1070 are provided below.

Product Specifications

Touch Screen Display

Display Type	TFT active matrix color LCD
Size	10.1 in. (257 mm) diagonal
Aspect Ratio	16:10 WUXGA
Resolution	1920 x 1200 pixels
Brightness	400 nits (cd/m ²)
Contrast	1000:1
Color Depth	24 bit, 16.7M colors
Illumination	Edgelit LED with auto brightness control
Viewing Angle	±80° horizontal, ±80° vertical
Touch Screen	Projected capacitive, 5-point multitouch capable

Buttons

Virtual Buttons	(6) Virtual buttons in collapsible universal tool bar, per-button show/hide, preconfigured with icons for Power, Home, Lights, Up, Down, and Microphone, optional custom programming via control system for additional functions
Reset	(1) Pin hole on bottom for hardware reset

Graphics Engine

Crestron HTML5 and Smart Graphics® software technology, multilanguage web browser¹, multilanguage on-screen keyboard, screensaver, single scalable streaming video window, native room scheduling applications^{4,5,6}, native Sonos® app¹, native Zoom Rooms™ app⁷, native Microsoft Teams® app, native Crestron Home™ OS app, setup and diagnostics via web browser, cloud, or on-screen UI

Room Scheduling Support

Crestron Scheduling App	Crestron Fusion® software, Microsoft Exchange Server® and Office 365® software, Google Calendar™ calendaring app and G Suite™ software, CollegeNET® 25Live® software, and Ad Astra™ software (IBM® Notes® software is also supported through Crestron Fusion on-premises server only) ⁴
Third-Party Apps	Includes support for various third-party scheduling applications. ^{5,6}

Languages

Smart Graphics	Arabic, Chinese (Simplified), Chinese (Traditional), Czech, Danish, Dutch, English (UK), English (US), Finnish, French, German, Greek, Hebrew, Hungarian, Italian, Japanese, Korean, Norwegian, Polish, Portuguese, Portuguese (Brazilian), Romanian, Russian, Slovak, Spanish, Swedish, Thai
On-screen Keyboard	Arabic, Chinese (Simplified), Croatian, Czech, Danish, Dutch, English (UK), English (US), Finnish, French (Canada), French (Switzerland), German, Hebrew, Hungarian, Italian, Japanese, Norwegian Bokmal, Polish, Portuguese, Russian, Serbian, Spanish, Swedish, Turkish
Voice Recognition¹	Afrikaans (South Africa); Chinese, Mandarin (China, Simplified); Chinese, Mandarin (Hong Kong, Simplified); Chinese, Mandarin (Taiwan, Traditional); Chinese, Yue (Hong Kong, Traditional); Czech (Czech Republic); Dutch (Netherlands); English (Australia); English (Canada); English (Generic); English (India); English (New Zealand); English (South Africa); English (UK); English (US); French (France); German (Germany); isiZulu (South Africa); Italian (Italy); Japanese (Japan); Korean (South Korea); Polish (Poland); Portuguese (Brazil); Russian (Russia); Spanish (Spain); Turkish (Turkey)
Web Browser¹	Arabic, Bulgarian, Catalan, Chinese, Croatian, Czech, Danish, Dutch, English, Filipino, Finnish, French, German, Greek, Hebrew, Hindi, Hungarian, Indonesian, Italian, Japanese, Korean, Latvian, Lithuanian, Norwegian Bokmal, Pashto, Persian, Polish, Portuguese, Romanian, Romansh, Russian, Serbian, Slovak, Slovenian, Spanish, Swedish, Thai, Turkish, Ukrainian, Vietnamese
Room Scheduling⁴	Chinese (Simplified), Chinese (Traditional), Danish, Dutch (Netherlands), English (US), English (UK), French, German, Hebrew, Italian, Japanese, Korean, Norwegian, Portuguese (Brazil), Portuguese (Portugal), Russian, Spanish, Swedish

Memory

RAM	2 GB LPDDR3
Storage	Firmware/Application: 16 GB eMMC pSLC
Maximum Project Size	600 MB

Wired Communications

Ethernet	100 Mbps, auto switching, auto negotiating, auto discovery, full/half duplex, TCP/IP, UDP/IP, CIP, DHCP, SSL, TLS, SSH, SFTP (SSH File Transfer Protocol), IEEE 802.1X, SNMP, IPv4 or IPv6, Active Directory® service authentication, HTTPS web browser setup, XiO Cloud® client, IEEE 802.3at compliant
-----------------	--

Wireless Communications

Transceiver	IEEE 802.11a/b/g/n/ac Wi-Fi (2.4 or 5 GHz 2-way RF), static IP or dynamic IP via DHCP
Security	64 and 128-bit WEP, WPA and WPA2-PSK with TKIP and AES
Range	Up to 50 ft (15 m), subject to site-specific conditions
Bluetooth® Hardware	Crestron Bluetooth beacon ^{2,8}

Streaming Decoder

Video Formats	H.265, H.264 (MPEG-4 part 10 AVC, MJPEG)
Audio Formats	AAC Stereo
Bitrates	Up to 25 Mbps (20 Mbps maximum recommended)
Input Resolutions	Up to 1920x1080@30fps
Protocol	RTSP

Audio

Features	Built-in microphone and speakers, Rava® SIP Intercom, voice recognition ^{1,2}
Audio Feedback Formats	MP3

Connectors

LAN PoE	(1) 8-pin RJ-45 connector, female, with 2 LED indicators; 100BASE-TX Ethernet port; PoE+ PD port; Green and yellow LEDs indicate Ethernet port status
USB	(1) USB Type-A connector, female; USB 2.0 host port

Power

PoE (Power over Ethernet)	IEEE 802.3at Type 2 compliant PoE+ PD (Powered Device); Normally requests 15 W from an 802.3at Type 2 PSE with LLDP advanced power management; With room scheduling and USB enabled, requests 18 W from an 802.3at Type 2 PSE with LLDP; Requests 30 W (PoE+ Class 4) from an 802.3at Type 2 PSE without LLDP; Requests 15.4 W (PoE Class 0) from an 802.3af (or 802.3at Type 1) PSE
----------------------------------	--

NOTE: Enabling the USB port requires use of an 802.3at Type 2 PoE+ PSE.

Environmental

Temperature	32 to 104°F (0 to 40°C)
Humidity	10% to 95% RH (noncondensing)
Heat Dissipation	44 BTU/hr

Construction

Housing	Plastic, smooth black or white finish, edge-to-edge glass with black or white surround
----------------	--

Dimensions

Height	5.29 in. (134 mm)
Width	9.63 in. (245 mm)
Depth	4.67 in. (119 mm)

Weight

2.44 lb (1105 g)

Compliance

Regulatory Model: M201923006
IC, CE, FCC Part 15 Class B digital device

Dimension Drawings

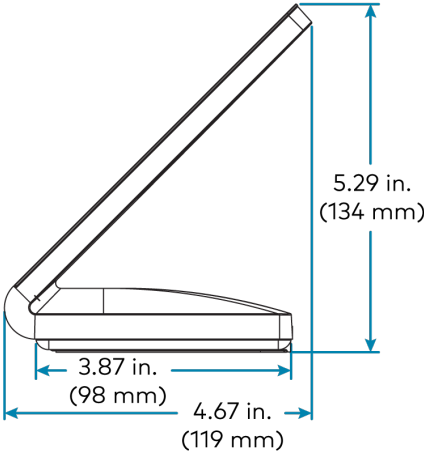
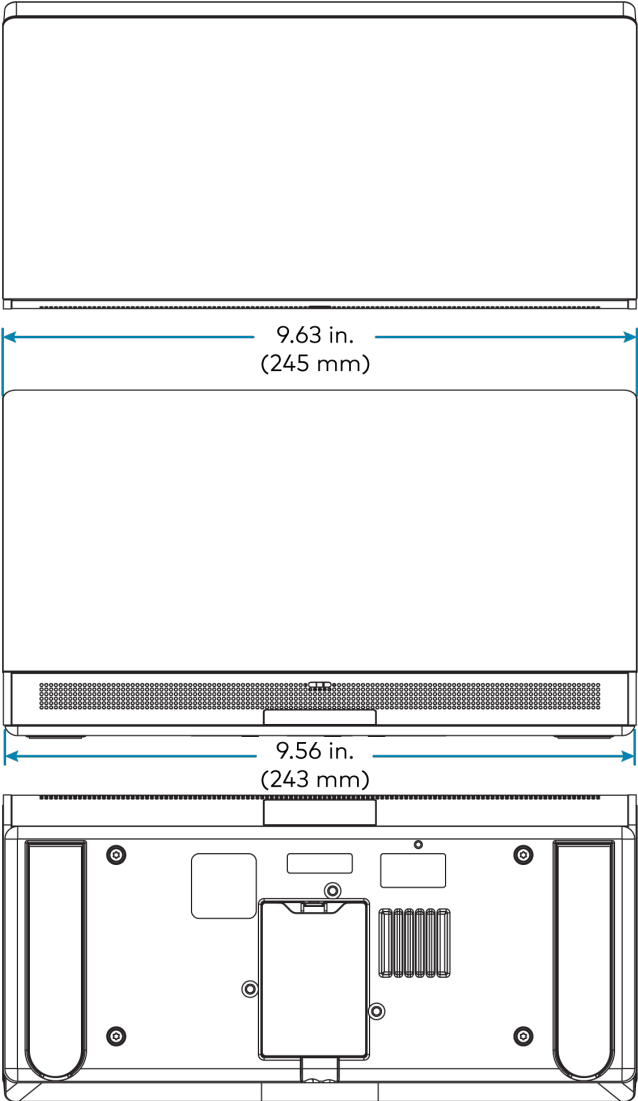

Notes:

1. Voice recognition, web browsing, weather information, and certain other functions require an internet connection.
2. The microphone and Bluetooth® transceiver may be defeated programmatically at any time.
3. Item(s) sold separately. Refer to each product's spec sheet for complete information.
4. Room scheduling mode requires the TS-1070 to be designated exclusively for room scheduling use, which precludes use of certain features and functions described in this spec sheet. Additionally, CollegeNET® 25Live® scheduling software and Ad Astra™ software do not support scheduling ad hoc meetings from the touch screen. For design assistance, contact the Crestron True Blue support team at www.crestron.com/support.
5. Refer to the firmware release notes for a list of all scheduling apps that are supported by that firmware release.
6. Additional subscriptions and/or licenses may be required. Refer to each provider's website for details about the capabilities and requirements of its scheduling application and services. Third-party apps typically run on the TS-1070 as they do on a tablet device. The TS-1070 runs only one app, which is selected at setup. Only the apps approved and delivered by Crestron can run on the TS-1070.
7. A complete Zoom Rooms solution requires a mini PC or Mac computer running Zoom software, a Zoom Rooms subscription, plus additional peripherals and cables. Visit zoom.us/zoomrooms for more information about Zoom Rooms capabilities, hardware requirements, and subscription plans. For design assistance, contact the Crestron True Blue support team at www.crestron.com/support.
8. The TS-1070 provides an integrated, equivalent alternative to the standalone [PP-100-W](#) beacon. For more details, refer to the PP-100-W spec sheet. Bluetooth technology is used solely for proximity detection and does not transmit or receive any control, multimedia, or personal data. Crestron Bluetooth beacons are only visible to Bluetooth enabled devices that are specifically programmed and configured to work with them.

TS-1070-GV Specifications

Product specifications for the TS-1070-GV are provided below.

Product Specifications

Touch Screen Display

Display Type	TFT active matrix color LCD
Size	10.1 in. (257 mm) diagonal
Aspect Ratio	16:10 WUXGA
Resolution	1920 x 1200 pixels
Brightness	400 nits (cd/m ²)
Contrast	1000:1
Color Depth	24 bit, 16.7M colors
Illumination	Edgelit LED with auto brightness control
Viewing Angle	±80° horizontal, ±80° vertical
Touch Screen	Projected capacitive, 5-point multitouch capable

Buttons

Virtual Buttons	(5) Virtual buttons in collapsible universal tool bar, per-button show/hide, preconfigured with icons for Power, Home, Lights, Up, and Down, optional custom programming via control system for additional functions
Reset	(1) Pin hole on bottom for hardware reset

Graphics Engine

Crestron HTML5 and Smart Graphics® software technology, multilanguage web browser¹, multilanguage on-screen keyboard, screensaver, single scalable streaming video window, native room scheduling applications^{3,4,5}, native Sonos® app¹, native Zoom Rooms™ app⁶, native Microsoft Teams® app, native Crestron Home™ OS app, setup and diagnostics via web browser, cloud, or on-screen UI

Room Scheduling Support

Crestron Scheduling App	Crestron Fusion® software, Microsoft Exchange Server® and Office 365® software, Google Calendar™ calendaring app and G Suite™ software, CollegeNET® 25Live® software, and Ad Astra™ software (IBM® Notes® software is also supported through Crestron Fusion on-premises server only) ³
Third-Party Apps	Includes support for various third-party scheduling applications. ^{4,5}

Languages

Smart Graphics	Arabic, Chinese (Simplified), Chinese (Traditional), Czech, Danish, Dutch, English (UK), English (US), Finnish, French, German, Greek, Hebrew, Hungarian, Italian, Japanese, Korean, Norwegian, Polish, Portuguese, Portuguese (Brazilian), Romanian, Russian, Slovak, Spanish, Swedish, Thai
On-screen Keyboard	Arabic, Chinese (Simplified), Croatian, Czech, Danish, Dutch, English (UK), English (US), Finnish, French (Canada), French (Switzerland), German, Hebrew, Hungarian, Italian, Japanese, Norwegian Bokmal, Polish, Portuguese, Russian, Serbian, Spanish, Swedish, Turkish
Web Browser¹	Arabic, Bulgarian, Catalan, Chinese, Croatian, Czech, Danish, Dutch, English, Filipino, Finnish, French, German, Greek, Hebrew, Hindi, Hungarian, Indonesian, Italian, Japanese, Korean, Latvian, Lithuanian, Norwegian Bokmal, Pashto, Persian, Polish, Portuguese, Romanian, Romansh, Russian, Serbian, Slovak, Slovenian, Spanish, Swedish, Thai, Turkish, Ukrainian, Vietnamese
Room Scheduling³	Chinese (Simplified), Chinese (Traditional), Danish, Dutch (Netherlands), English (US), English (UK), French, German, Hebrew, Italian, Japanese, Korean, Norwegian, Portuguese (Brazil), Portuguese (Portugal), Russian, Spanish, Swedish

Memory

RAM	2 GB LPDDR3
Storage	Firmware/Application: 16 GB eMMC pSLC
Maximum Project Size	600 MB

Wired Communications

Ethernet	100 Mbps, auto switching, auto negotiating, auto discovery, full/half duplex, TCP/IP, UDP/IP, CIP, DHCP, SSL, TLS, SSH, SFTP (SSH File Transfer Protocol), IEEE 802.1X, SNMP, IPv4 or IPv6, Active Directory [®] service authentication, HTTPS web browser setup, IEEE 802.3at compliant
USB	USB 2.0 host

Streaming Decoder

Video Formats	H.265, H.264 (MPEG-4 part 10 AVC, MJPEG)
Audio Formats	AAC Stereo
Bitrates	Up to 25 Mbps (20 Mbps maximum recommended)
Input Resolutions	Up to 1920x1080@30fps
Protocol	RTSP

Audio

Features	Built-in speakers
Audio Feedback Formats	MP3

Connectors

LAN PoE	(1) 8-pin RJ-45 connector, female, with 2 LED indicators; 100BASE-TX Ethernet port; PoE+ PD port; Green and yellow LEDs indicate Ethernet port status
USB	(1) USB Type-A connector, female; USB 2.0 host port

Power

PoE (Power over Ethernet)	IEEE 802.3at Type 2 compliant PoE+ PD (Powered Device); Normally requests 15 W from an 802.3at Type 2 PSE with LLDP advanced power management; With room scheduling and USB enabled, requests 18 W from an 802.3at Type 2 PSE with LLDP; Requests 30 W (PoE+ Class 4) from an 802.3at Type 2 PSE without LLDP; Requests 15.4 W (PoE Class 0) from an 802.3af (or 802.3at Type 1) PSE
----------------------------------	--

NOTE: Enabling the USB port requires use of an 802.3at Type 2 PoE+ PSE.

Environmental

Temperature	32 to 104°F (0 to 40°C)
Humidity	10% to 95% RH (noncondensing)
Heat Dissipation	44 BTU/hr

Construction

Housing	Plastic, smooth black or white finish, edge-to-edge glass with black or white surround
----------------	--

Dimensions

Height	5.29 in. (134 mm)
Width	9.63 in. (245 mm)
Depth	4.67 in. (119 mm)

Weight

2.44 lb (1105 g)

Compliance

Regulatory Model: M201923006

IC, CE, FCC Part 15 Class B digital device

Dimension Drawings

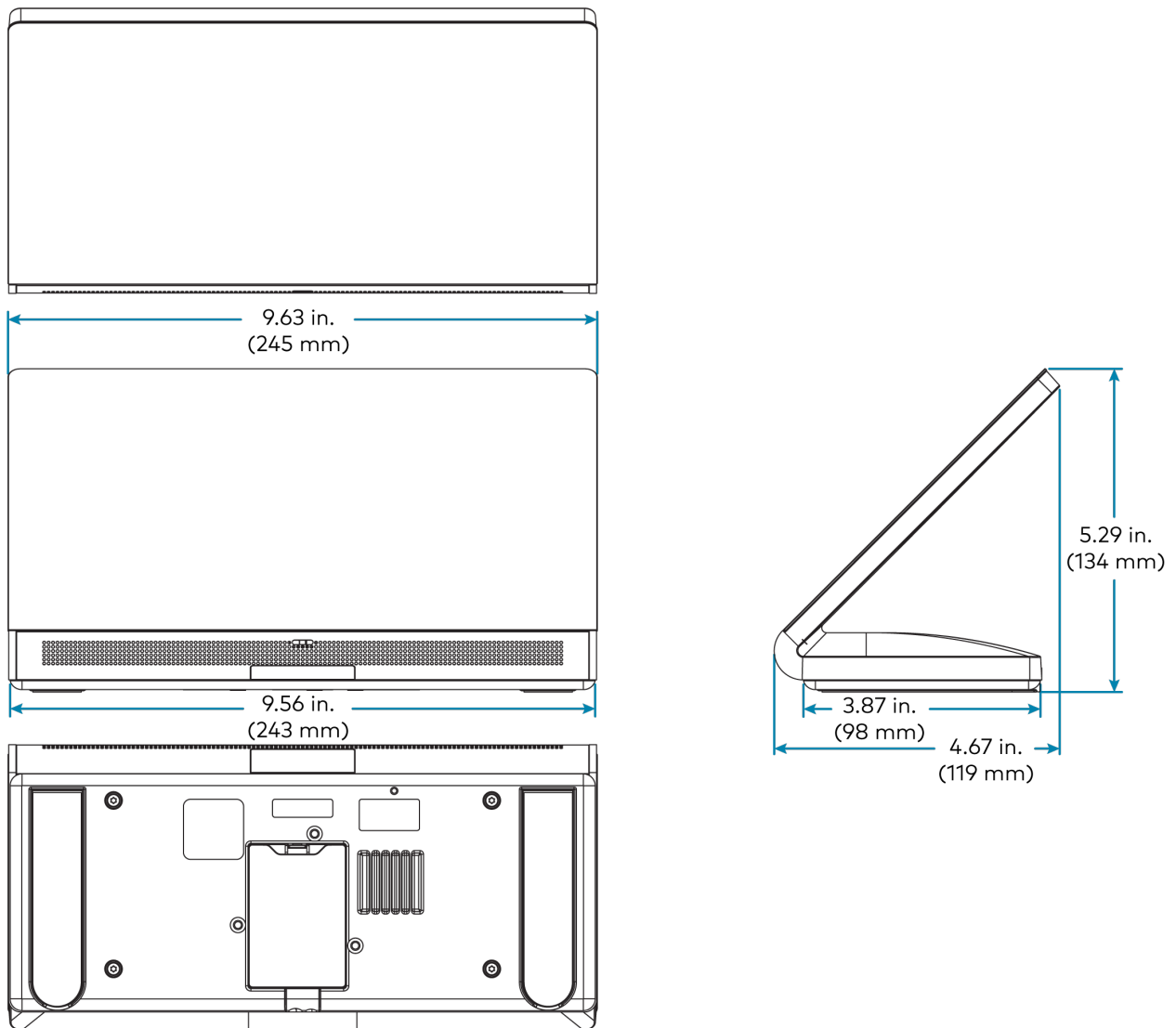

Notes:

1. Web browsing, weather information, and certain other functions require an internet connection.
2. Item(s) sold separately. Refer to each product's spec sheet for complete information.
3. Room scheduling mode requires the TS-1070-GV to be designated exclusively for room scheduling use, which precludes use of certain features and functions described in this spec sheet. Additionally, CollegeNET® 25Live® scheduling software and Ad Astra™ software do not support scheduling ad hoc meetings from the touch screen. For design assistance, contact the Crestron True Blue support team at www.crestron.com/support.
4. Refer to the firmware release notes for a list of all scheduling apps that are supported by that firmware release.
5. Additional subscriptions and/or licenses may be required. Refer to each provider's website for details about the capabilities and requirements of its scheduling application and services. Third-party apps typically run on the TS-1070-GV as they do on a tablet device. The TS-1070-GV runs only one app, which is selected at setup. Only the apps approved and delivered by Crestron can run on the TS-1070-GV.
6. A complete Zoom Rooms solution requires a mini PC or Mac computer running Zoom software, a Zoom Rooms subscription, plus additional peripherals and cables. Visit zoom.us/zoomrooms for more information about Zoom Rooms capabilities, hardware requirements, and subscription plans. For design assistance, contact the Crestron True Blue support team at www.crestron.com/support.

TS-1070R Specifications

Product specifications for the TS-1070R are provided below.

Product Specifications

Touch Screen Display

Display Type	TFT active matrix color LCD
Size	10.1 in. (257 mm) diagonal
Aspect Ratio	16:10 WUXGA
Resolution	1920 x 1200 pixels
Brightness	400 nits (cd/m ²)
Contrast	1000:1
Color Depth	24 bit, 16.7M colors
Illumination	Edgelit LED with auto brightness control
Viewing Angle	±80° horizontal, ±80° vertical
Touch Screen	Projected capacitive, 5-point multitouch capable

Buttons

Virtual Buttons	(6) Virtual buttons in collapsible universal tool bar, per-button show/hide, preconfigured with icons for Power, Home, Lights, Up, Down, and Microphone
Reset	(1) Pin hole on bottom for hardware reset

Graphics Engine

Native Sonos® app¹, native Crestron Home™ OS app, touch screen setup and diagnostics via web browser or on-screen UI, Crestron Home setup and diagnostics via Crestron Home Setup app

Languages

On-screen Keyboard	Arabic, Chinese (Simplified), Croatian, Czech, Danish, Dutch, English (UK), English (US), Finnish, French (Canada), French (Switzerland), German, Hebrew, Hungarian, Italian, Japanese, Norwegian Bokmal, Polish, Portuguese, Russian, Serbian, Spanish, Swedish, Turkish
---------------------------	---

Memory

RAM	2 GB LPDDR3
Storage	Firmware/Application: 16 GB eMMC pSLC

Wired Communications

Ethernet	100 Mbps, auto switching, auto negotiating, auto discovery, full/half duplex, TCP/IP, UDP/IP, CIP, DHCP, SSL, TLS, SSH, SFTP (SSH File Transfer Protocol), IEEE 802.1X, SNMP, IPv4 or IPv6, Active Directory® service authentication, HTTPS web browser setup, IEEE 802.3at compliant
USB	USB 2.0 host

Wireless Communications

Transceiver	IEEE 802.11a/b/g/n/ac Wi-Fi (2.4 or 5 GHz 2-way RF), static IP or dynamic IP via DHCP
Security	64 and 128-bit WEP, WPA and WPA2-PSK with TKIP and AES
Range	Up to 50 ft (15 m), subject to site-specific conditions

Streaming Decoder

Video Formats	H.265, H.264 (MPEG-4 part 10 AVC, MJPEG)
Audio Formats	AAC Stereo
Bitrates	Up to 25 Mbps (20 Mbps maximum recommended)
Input Resolutions	Up to 1920x1080@30fps
Protocol	RTSP

Audio

Features	Built-in microphone and speakers, Rava® SIP Intercom ^{1,2}
Audio Feedback Formats	MP3

Connectors

LAN PoE	(1) 8-pin RJ-45 connector, female, with 2 LED indicators; 100BASE-TX Ethernet port; PoE+ PD port; Green and yellow LEDs indicate Ethernet port status
USB	(1) USB Type-A connector, female; USB 2.0 host port

Power

PoE (Power over Ethernet)	IEEE 802.3at Type 2 compliant PoE+ PD (Powered Device); Normally requests 15 W from an 802.3at Type 2 PSE with LLDP advanced power management; With room scheduling and USB enabled, requests 18 W from an 802.3at Type 2 PSE with LLDP; Requests 30 W (PoE+ Class 4) from an 802.3at Type 2 PSE without LLDP; Requests 15.4 W (PoE Class 0) from an 802.3af (or 802.3at Type 1) PSE
----------------------------------	--

Environmental

Temperature	32 to 104°F (0 to 40°C)
Humidity	10% to 95% RH (noncondensing)
Heat Dissipation	44 BTU/hr

Construction

Housing	Plastic, smooth black or white finish, edge-to-edge glass with black or white surround
----------------	--

Dimensions

Height	5.29 in. (134 mm)
Width	9.63 in. (245 mm)
Depth	4.67 in. (119 mm)

Weight

2.44 lb (1105 g)

Compliance

Regulatory Model: M201923006
IC, CE, FCC Part 15 Class B digital device

Dimension Drawings

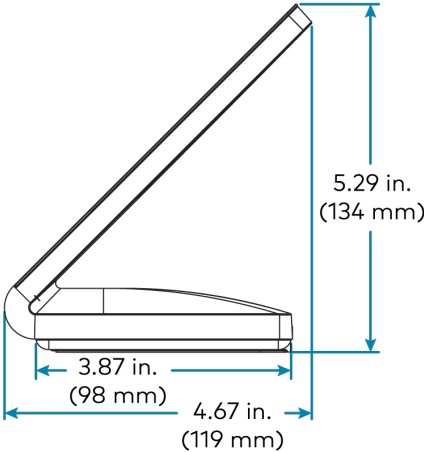
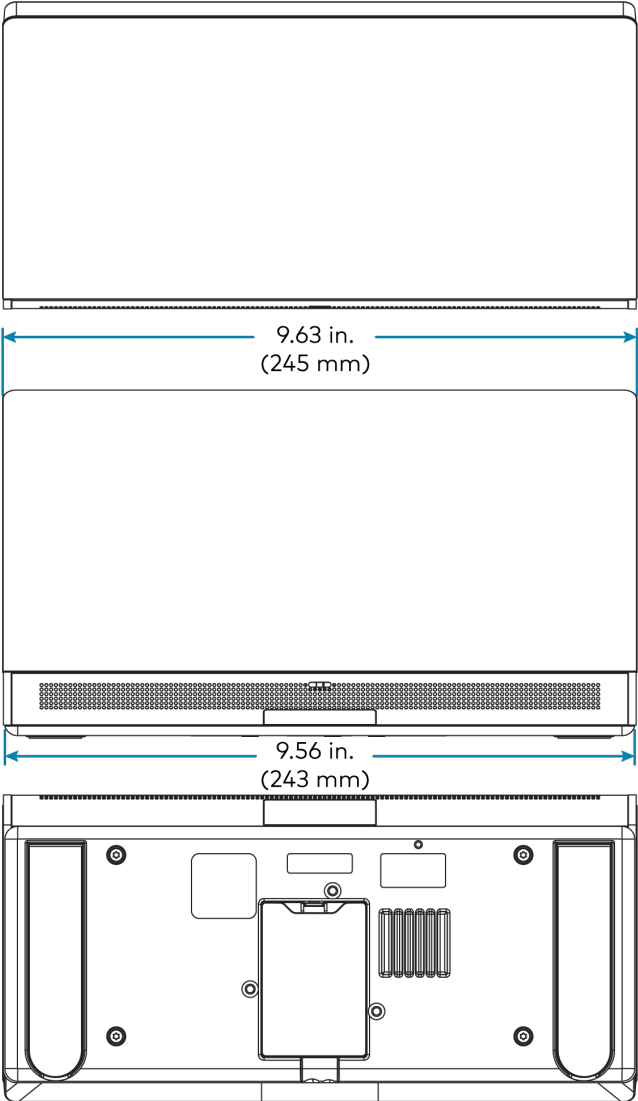

Notes:

- 1. Certain other functions require an internet connection.
- 2. The microphone may be defeated programmatically at any time.
- 3. Item(s) sold separately. Refer to each product's spec sheet for complete information.

Installation

Refer to the following sections for instructions on how to install the various TS-70 Series models.

- [TS-770 and TS-1070 Installation on page 63](#)
- [TS-770-GV and TS-1070-GV Installation on page 70](#)
- [TS-770R and TS-1070R Installation on page 76](#)

TS-770 and TS-1070 Installation

Use the following procedures to install the TS-770 and TS-1070 touch screens.

Place the Touch Screen

The touch screen may be placed on any flat, level surface such as a desk, conference table, lectern, or podium. The rubber strips on the bottom of the touch screen prevent it from moving easily.

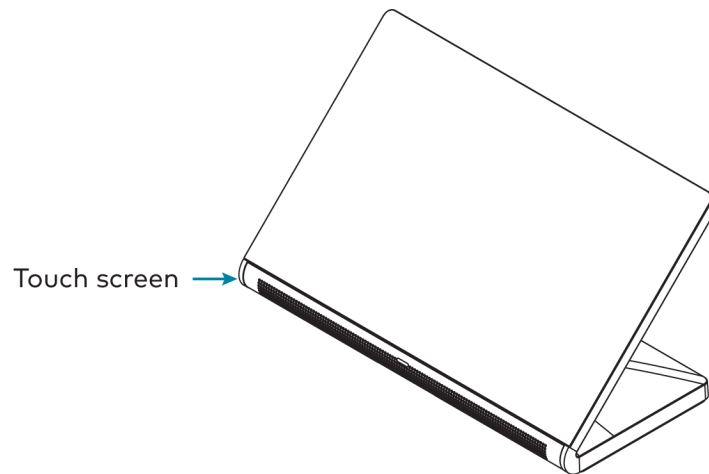

NOTE: To clean or disinfect a touch screen display, use a soft, clean, damp (not wet) cloth with any commercially available non-ammonia glass cleaner or disinfectant cleaner. Bezels do not provide a complete watertight seal, so apply cleaning solution to the cloth rather than the surface of the touch screen. Wipe the touch screen clean and avoid ingress of moisture beneath the bezels.

Connect the Touch Screen

Route all necessary cables to the touch screen, and then make connections to the bottom of the touch screen.

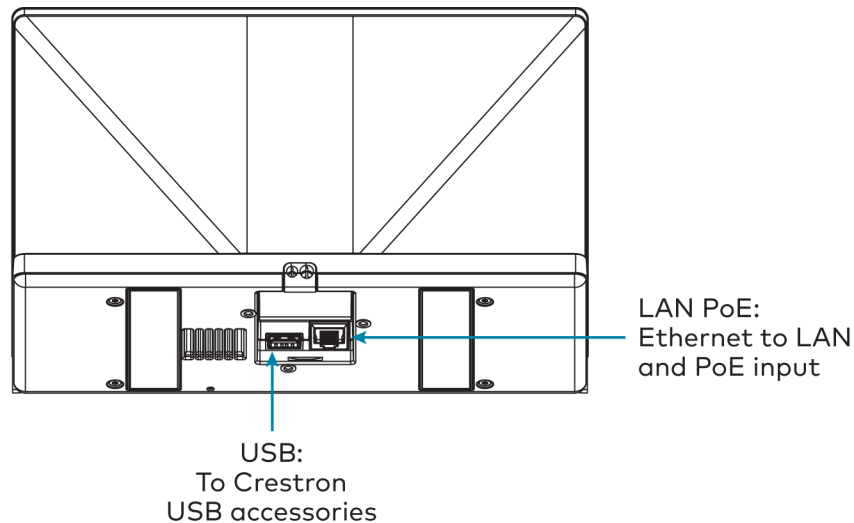

Observe the following when connecting the touch screen:

- Power and data connection is provided to the touch screen by a single Ethernet cable. A Crestron PoE (Power over Ethernet) power supply, such as the [PWE-4803RU](#), or a PoE-capable network switch is recommended (neither included).
- The USB port is used to connect compatible Crestron LED accessories to the touch screen.

NOTE: The TS-770 may use either PoE or PoE+ to supply power to compatible LED accessories over USB; the TS-1070 requires at minimum PoE+ to supply power to LED accessories over USB.

- Apply power after all connections have been made.

Install the Cable Grommet

The touch screen ships with two cable grommets that can be used depending on the planned cable route to the touch screen:

- Use the open grommet if cables will be routed out from the rear of the touch screen. A cable compartment cover is also provided for this installation.
- Use the closed grommet if cables will be routed from underneath the touch screen.

To install the cable grommet:

1. If using the open grommet, push the cables into the openings in the grommet.
2. Push the grommet into its slot on the bottom of the touch screen so that the two tabs on either side of the grommet engage the slots in the touch screen.

3. If using the open grommet, slide the cable compartment cover into its slot on the bottom of the touch screen so that the front tab engages the latch.

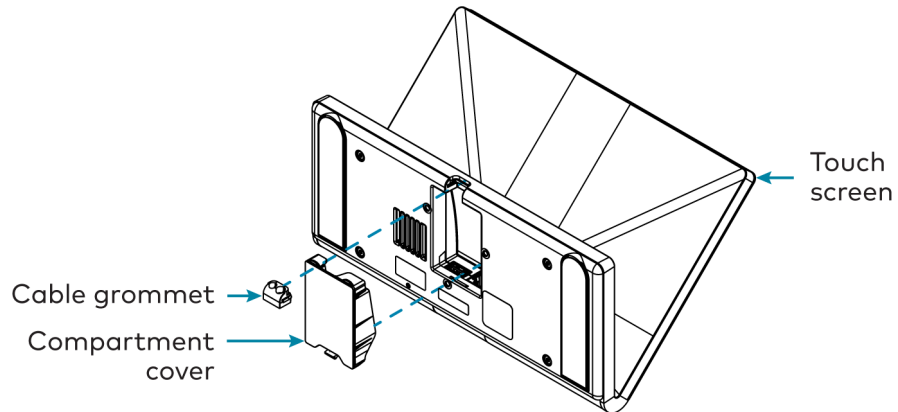

Configure the Touch Screen

When power is applied for the first time, the following screen is displayed. The touch screen may take up to two minutes to boot.



Touch the screen to display the main Setup screen (TS-1070 shown).

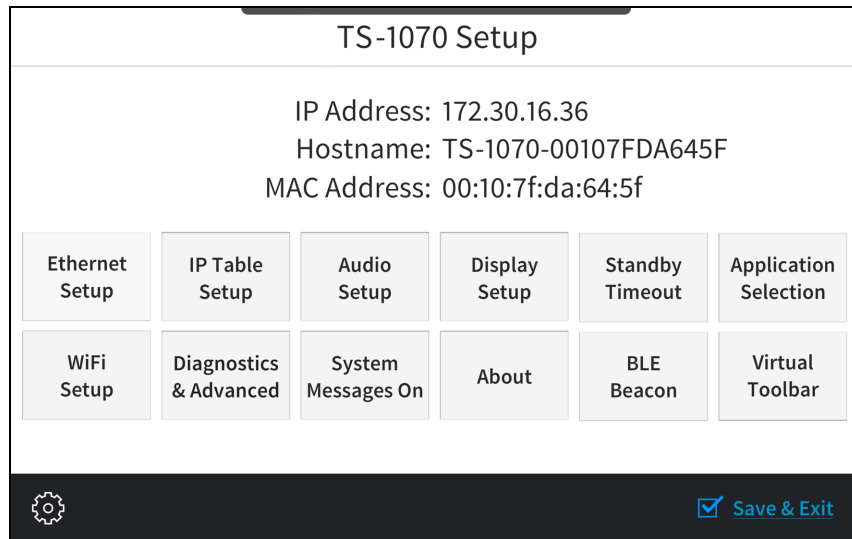

Device settings for the touch screen may be configured using the built-in setup screens or the web configuration interface. For more information on configuring the touch screen, refer to [Configuration on page 81](#).

Access the Device Setup Screens

To access the built-in setup screens, place five fingers on the display and hold for 15 seconds.

Use the setup screens to configure various settings for the touch screen, including Ethernet setup, IP table setup, audio setup, display setup, standby timeout, application selection, Wi-Fi network setup, diagnostics, the Bluetooth® beacon, and the virtual toolbar.

Access the Web Configuration Interface

The touch screen provides a web configuration interface that is used to view and configure various touch screen settings and to select an application. The interface can be accessed using the touch screen IP address or the XiO Cloud® service.

Touch Screen IP Address

To access the web configuration interface using the touch screen IP address:

1. Ensure that the touch screen is connected to the network.
2. Use the Device Discovery tool in Crestron Toolbox™ software to discover the touch screen and its IP address on the network.
3. Enter the touch screen IP address into a web browser.

XiO Cloud Service

The [XiO Cloud® service](#) allows supported devices across an enterprise to be managed and configured from one central and secure location in the cloud. Supported Crestron® devices are configured to connect to the service out of the box.

Use of the service requires a registered XiO Cloud account. To register for an XiO Cloud account, refer to www.crestron.com/Support/Tools/Licensing-Registration/XiO-Cloud-Registration-Room-Licenses.

NOTE: The device may be disconnected from the XiO Cloud service by navigating to the **Cloud Services** tab in Crestron Toolbox™ software (**Functions > Device Info > Cloud Services**). For details, refer to the Crestron Toolbox help file.

To connect the device to the XiO Cloud service:

1. Record the MAC address and serial number that are labeled on the shipping box or the device. The MAC address and serial number are required to add the device to the XiO Cloud service.

NOTE: If the device has multiple MAC addresses, use the MAC address that is providing the primary connection back to the network. For most devices, the Ethernet MAC address should be used. However, if your device is connecting to the network over a different protocol (such as Wi-Fi® communications), use the MAC address for that protocol instead.

2. Log in to your XiO Cloud account at portal.crestron.io.
3. Claim the device to the XiO Cloud service as described in the [XiO Cloud User Guide](#).

Select the device from the cloud interface to view its status and settings. The device may now also be managed and assigned to a group or room. For more information, refer to the [XiO Cloud User Guide](#).

NOTE: For XiO Cloud accounts with room-based licenses, the device must be added to a licensed room before its status and settings can be viewed.

Create an Admin Account

The first time the web configuration interface is accessed, a page is displayed asking the user to create an admin account. A similar message is displayed when connecting to the control system in Crestron Toolbox software if an admin account has not already been created.

To create an admin account:

1. Enter a username and password for the admin account in the appropriate text fields.

CAUTION: Do not lose the username and password for the admin account, as the control system must be reset to factory settings to regain access.

2. Select **OK** to create the admin account. The web configuration interface refreshes to show the standard login page.
3. Reenter the credentials created in step 1 and select **Sign In**.

NOTE: The username and password must also be entered when connecting from Crestron Toolbox or XPanel.

Set the Time Zone

The time zone must be set on the touch screen if it will not be paired with a control system IP table.

To set the time zone:

1. Access the web configuration interface using either the touch screen IP address or the XiO Cloud service.
2. Select the **Settings** tab.
3. Navigate to **System Setup > Time/Date**.
4. Select the time zone where the touch screen will be used from the **Time Zone** drop-down menu.
5. Select **Save Changes** on the top right of the screen.

Select an Application

The touch screen ships with various built-in applications. An application may be selected from the default project that ships with the touch screen.

NOTE: Applications can be selected and configured from the device setup screens or from the web configuration interface at any time. For more information, refer to [Application Selection on page 162](#).

To select a touch screen application:

1. Tap **Touch Here to Enable a Specific Application** on the device splash screen. Refer to the first image in [TS-770 and TS-1070 Installation on page 63](#).
2. Select the desired touch screen application from the **Choose Application Below** menu that is displayed.

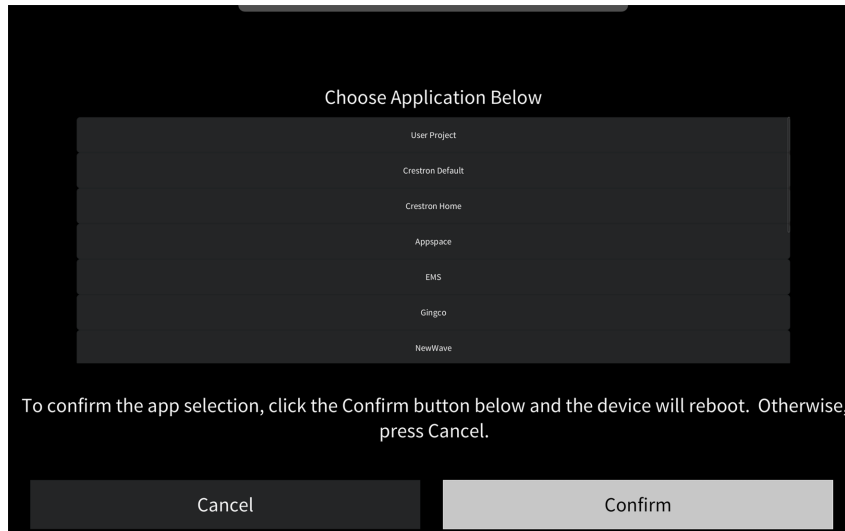

3. Select **Confirm**. The touch screen restarts to display the user interface for the selected application.

If a custom user project will be used, tap **User Project**. Custom user projects can be uploaded using the web configuration interface or Crestron Toolbox software.

TS-770-GV and TS-1070-GV

Installation

Use the following procedures to install the TS-770-GV and TS-1070-GV touch screens.

Place the Touch Screen

The touch screen may be placed on any flat, level surface such as a desk, conference table, lectern, or podium. The rubber strips on the bottom of the touch screen prevent it from moving easily.

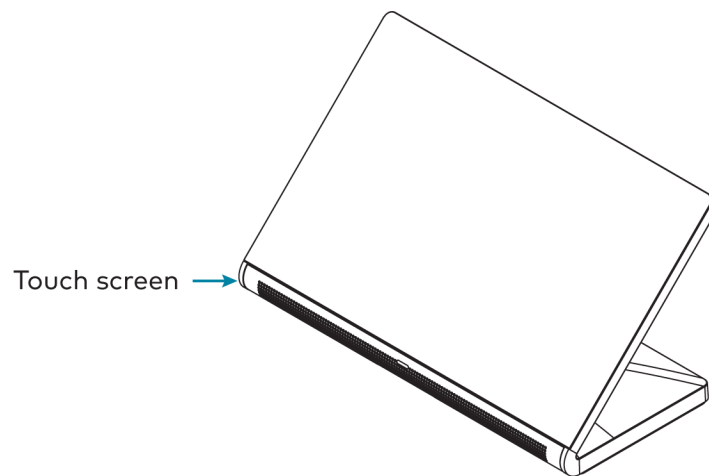

NOTE: To clean or disinfect a touch screen display, use a soft, clean, damp (not wet) cloth with any commercially available non-ammonia glass cleaner or disinfectant cleaner. Bezels do not provide a complete watertight seal, so apply cleaning solution to the cloth rather than the surface of the touch screen. Wipe the touch screen clean and avoid ingress of moisture beneath the bezels.

Connect the Touch Screen

Route all necessary cables to the touch screen, and then make connections to the bottom of the touch screen.

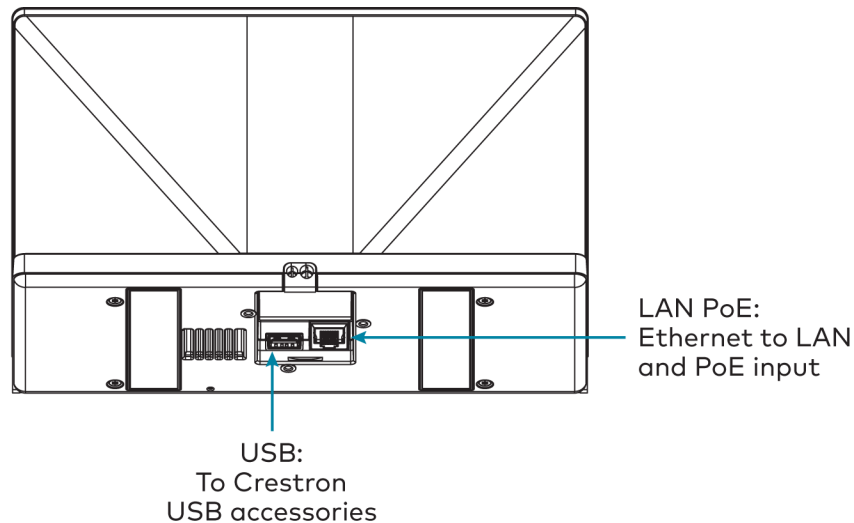

Observe the following when connecting the touch screen:

- Power and data connection is provided to the touch screen by a single Ethernet cable. A Crestron PoE (Power over Ethernet) power supply, such as the [PWE-4803RU](#), or a PoE-capable network switch is recommended (neither included).
- The USB port is used to connect compatible Crestron LED accessories to the touch screen.

NOTE: The TS-770-GV may use either PoE or PoE+ to supply power to compatible LED accessories over USB; the TS-1070-GV requires at minimum PoE+ to supply power to LED accessories over USB.

- Apply power after all connections have been made.

Install the Cable Grommet

The touch screen ships with two cable grommets that can be used depending on the planned cable route to the touch screen:

- Use the open grommet if cables will be routed out from the rear of the touch screen. A cable compartment cover is also provided for this installation.
- Use the closed grommet if cables will be routed from underneath the touch screen.

To install the cable grommet:

1. If using the open grommet, push the cables into the openings in the grommet.
2. Push the grommet into its slot on the bottom of the touch screen so that the two tabs on either side of the grommet engage the slots in the touch screen.

3. If using the open grommet, slide the cable compartment cover into its slot on the bottom of the touch screen so that the front tab engages the latch.

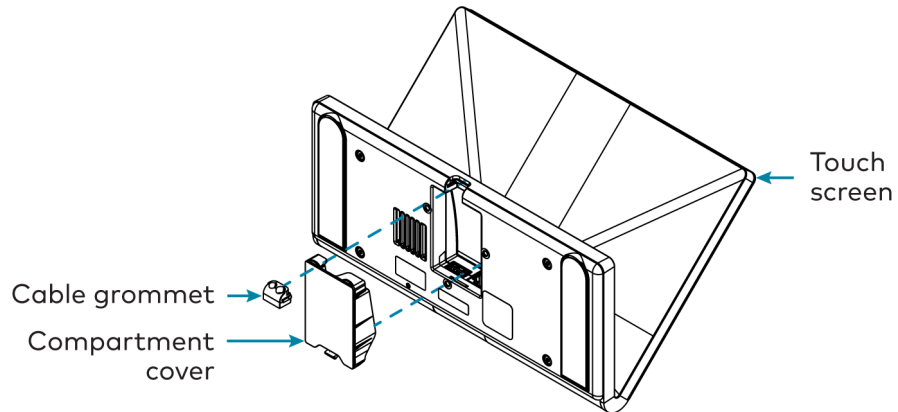

Configure the Touch Screen

When power is applied for the first time, the following screen is displayed. The touch screen may take up to two minutes to boot.



Touch the screen to display the main Setup screen (TS-1070 shown).

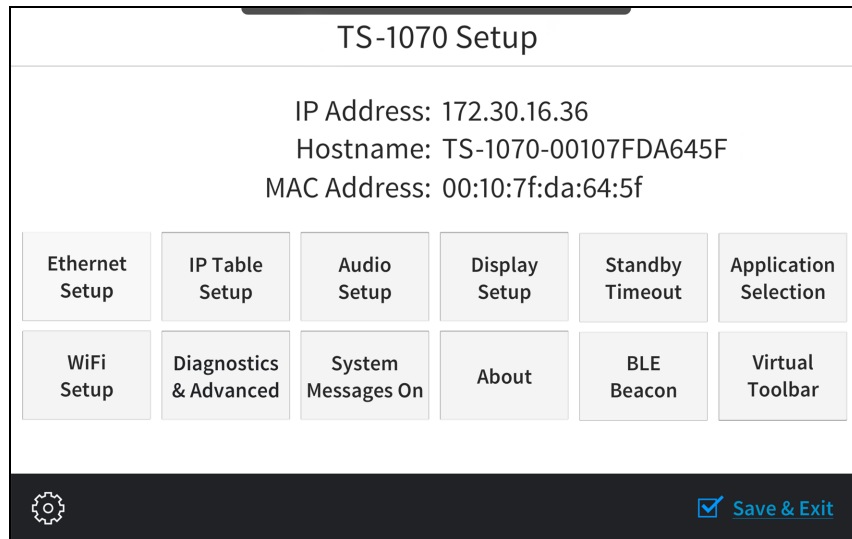

Device settings for the touch screen may be configured using the built-in setup screens or the web configuration interface. For more information on configuring the touch screen, refer to [Configuration on page 81](#).

Access the Device Setup Screens

To access the built-in setup screens, place five fingers on the display and hold for 15 seconds.

Use the setup screens to configure various settings for the touch screen, including Ethernet setup, IP table setup, audio setup, display setup, standby timeout, application selection, diagnostics, and the virtual toolbar.

Access the Web Configuration Interface

The touch screen provides a web configuration interface that is used to view and configure various touch screen settings and to select an application. The interface can be accessed using the touch screen IP address.

To access the web configuration interface using the touch screen IP address:

1. Ensure that the touch screen is connected to the network.
2. Use the Device Discovery tool in Crestron Toolbox™ software to discover the touch screen and its IP address on the network.
3. Enter the touch screen IP address into a web browser.

Create an Admin Account

The first time the web configuration interface is accessed, a page is displayed asking the user to create an admin account. A similar message is displayed when connecting to the control system in Crestron Toolbox software if an admin account has not already been created.

To create an admin account:

1. Enter a username and password for the admin account in the appropriate text fields.

CAUTION: Do not lose the username and password for the admin account, as the control system must be reset to factory settings to regain access.

2. Select **OK** to create the admin account. The web configuration interface refreshes to show the standard login page.
3. Reenter the credentials created in step 1 and select **Sign In**.

NOTE: The username and password must also be entered when connecting from Crestron Toolbox or XPanel.

Set the Time Zone

The time zone must be set on the touch screen if it will not be paired with a control system IP table.

To set the time zone:

1. Access the web configuration interface using either the touch screen IP address.
2. Select the **Settings** tab.
3. Navigate to **System Setup > Time/Date**.
4. Select the time zone where the touch screen will be used from the **Time Zone** drop-down menu.
5. Select **Save Changes** on the top right of the screen.

Select an Application

The touch screen ships with various built-in applications. An application may be selected from the default project that ships with the touch screen.

NOTE: Applications can be selected and configured from the device setup screens or from the web configuration interface at any time. For more information, refer to [Application Selection on page 162](#).

To select a touch screen application:

1. Tap **Touch Here to Enable a Specific Application** on the device splash screen. Refer to the first image in [TS-770-GV and TS-1070-GV Installation on page 70](#).

2. Select the desired touch screen application from the **Choose Application Below** menu that is displayed.

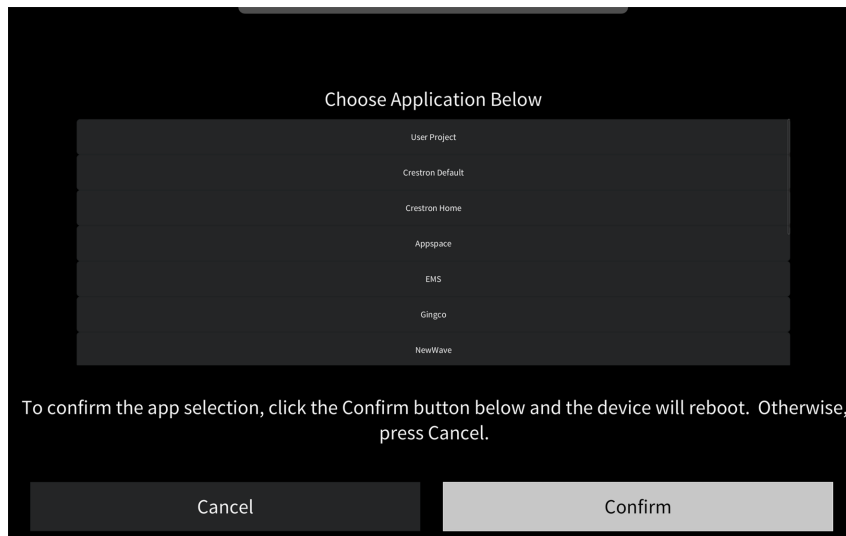

3. Select **Confirm**. The touch screen restarts to display the user interface for the selected application.

If a custom user project will be used, tap **User Project**. Custom user projects can be uploaded using the web configuration interface or Crestron Toolbox software.

TS-770R and TS-1070R Installation

Use the following procedures to install the TS-770R and TS-1070R touch screens.

Place the Touch Screen

The touch screen may be placed on any flat, level surface such as a desk, conference table, lectern, or podium. The rubber strips on the bottom of the touch screen prevent it from moving easily.

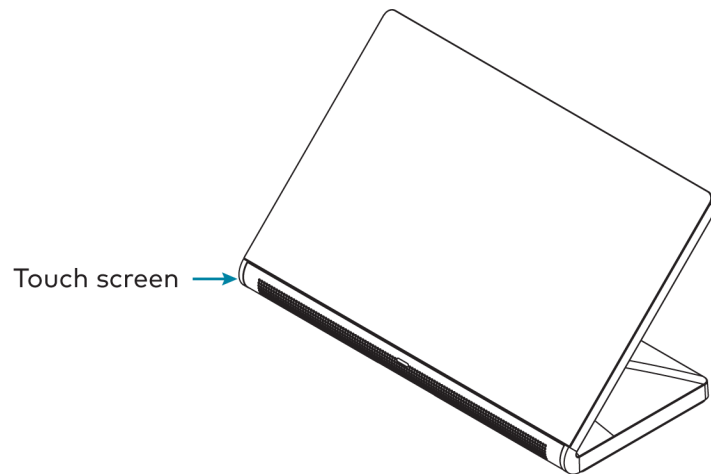

NOTE: To clean or disinfect a touch screen display, use a soft, clean, damp (not wet) cloth with any commercially available non-ammonia glass cleaner or disinfectant cleaner. Bezels do not provide a complete watertight seal, so apply cleaning solution to the cloth rather than the surface of the touch screen. Wipe the touch screen clean and avoid ingress of moisture beneath the bezels.

Connect the Touch Screen

Route all necessary cables to the touch screen, and then make connections to the bottom of the touch screen.

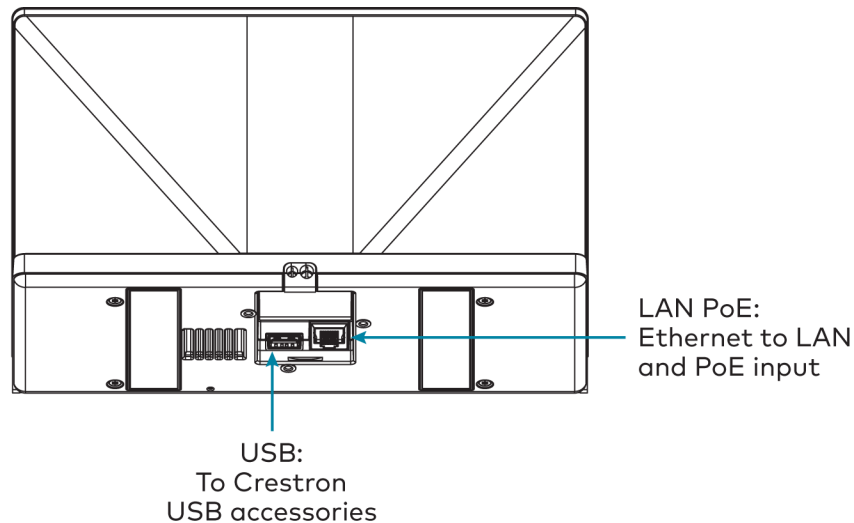

Observe the following when connecting the touch screen:

- Power and data connection is provided to the touch screen by a single Ethernet cable. A Crestron PoE (Power over Ethernet) power supply, such as the [PWE-4803RU](#), or a PoE-capable network switch is recommended (neither included).
- Apply power after all connections have been made.

Install the Cable Grommet

The touch screen ships with two cable grommets that can be used depending on the planned cable route to the touch screen:

- Use the open grommet if cables will be routed out from the rear of the touch screen. A cable compartment cover is also provided for this installation.
- Use the closed grommet if cables will be routed from underneath the touch screen.

To install the cable grommet:

1. If using the open grommet, push the cables into the openings in the grommet.
2. Push the grommet into its slot on the bottom of the touch screen so that the two tabs on either side of the grommet engage the slots in the touch screen.
3. If using the open grommet, slide the cable compartment cover into its slot on the bottom of the touch screen so that the front tab engages the latch.

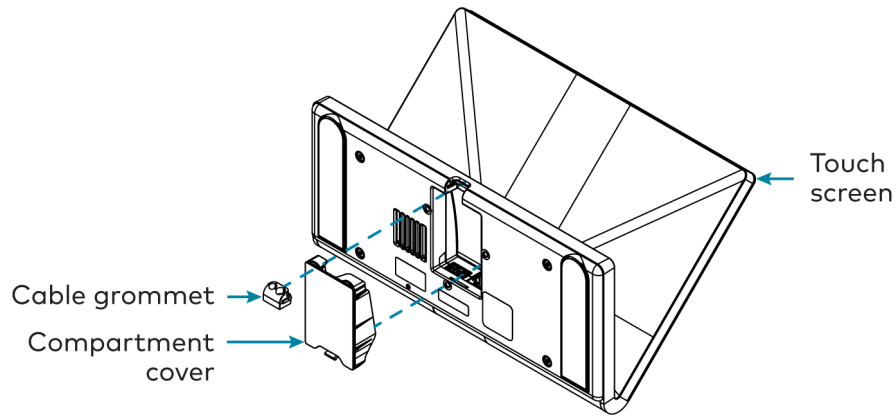

Configure the Touch Screen

When power is applied for the first time, the touch screen boots to the Crestron Home application setup screen. The touch screen may take up to two minutes to boot.

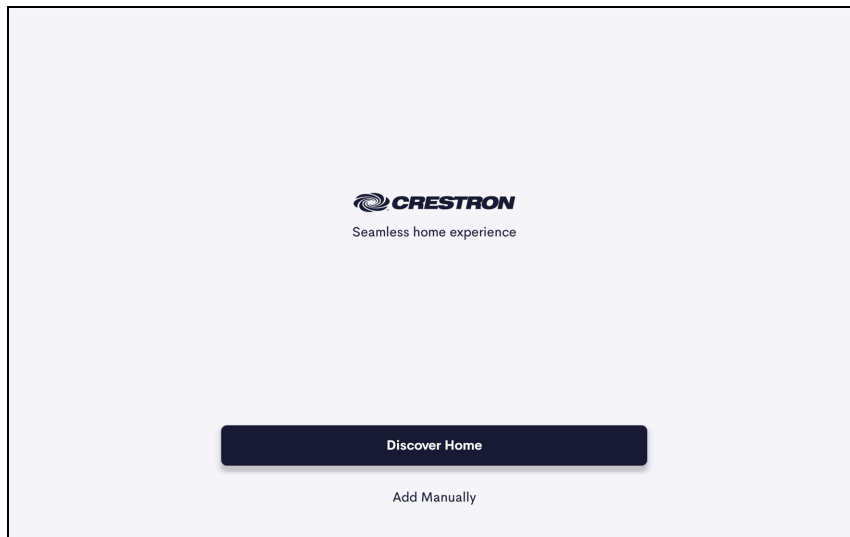

Device settings for the touch screen may be configured using the built-in setup screens or the web configuration interface. For more information on configuring the touch screen, refer to [Configuration on page 81](#).

Access the Device Setup Screens

To access the built-in setup screens, place five fingers on the display and hold for 15 seconds. The main Setup screen is displayed (TS-1070 shown).

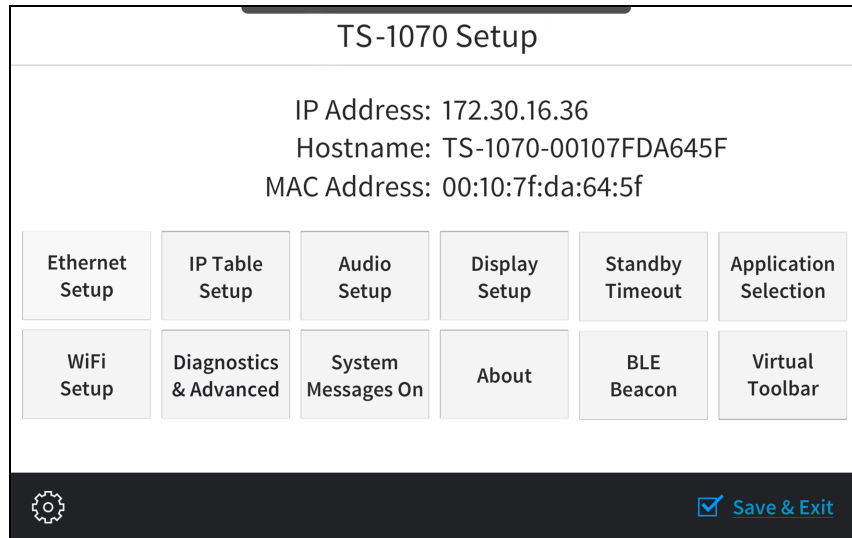

Use the setup screens to configure various settings for the touch screen, including Ethernet setup, IP table setup, audio setup, display setup, standby timeout, Wi-Fi network setup, and diagnostics.

NOTE: Time zone settings do not need to be configured on the touch screen, as these settings will be pushed to the touch screen from the control system running Crestron Home.

Access the Web Configuration Interface

The touch screen provides a web configuration interface that is used to view and configure various touch screen settings. The interface can be accessed using the touch screen IP address.

To access the web configuration interface using the touch screen IP address:

1. Ensure that the touch screen is connected to the network.
2. Use the Device Discovery tool in Crestron Toolbox™ software to discover the touch screen and its IP address on the network.
3. Enter the touch screen IP address into a web browser.

Create an Admin Account

The first time the web configuration interface is accessed, a page is displayed asking the user to create an admin account. A similar message is displayed when connecting to the control system in Crestron Toolbox software if an admin account has not already been created.

To create an admin account:

1. Enter a username and password for the admin account in the appropriate text fields.

CAUTION: Do not lose the username and password for the admin account, as the control system must be reset to factory settings to regain access.

2. Select **OK** to create the admin account. The web configuration interface refreshes to show the standard login page.
3. Reenter the credentials created in step 1 and select **Sign In**.

NOTE: The username and password must also be entered when connecting from Crestron Toolbox or XPanel.

Configure the Crestron Home App

The touch screen ships with the Crestron Home user control application running out of the box. The application must be paired with an existing Crestron Home system prior to use.

NOTE: A configured Crestron Home system is required for this application. For more information, refer to the [Crestron Home OS Product Manual](#).

To set up the Crestron Home user control application on the touch screen:

1. From the Crestron Home application, tap **Discover Home** to discover a Crestron Home system on the network, or tap **Add Manually** to enter connection information for a Crestron Home system manually.
2. Complete any additional setup and configuration procedures as described in the [Crestron Home OS Product Manual](#).

Configuration

Prior to configuration, ensure the device is running the latest firmware. To update the firmware, refer to [Update Firmware on page 122](#).

When power is applied for the first time, the following screen is displayed. The touch screen may take up to two minutes to boot.

NOTE: TS-70R series touch screens boot to the Crestron Home application setup screen. For more information on configuring the Crestron Home application, refer to the [Crestron Home OS™ Product Manual](#).

Touch the screen to display the main Setup screen (TS-1070 shown)

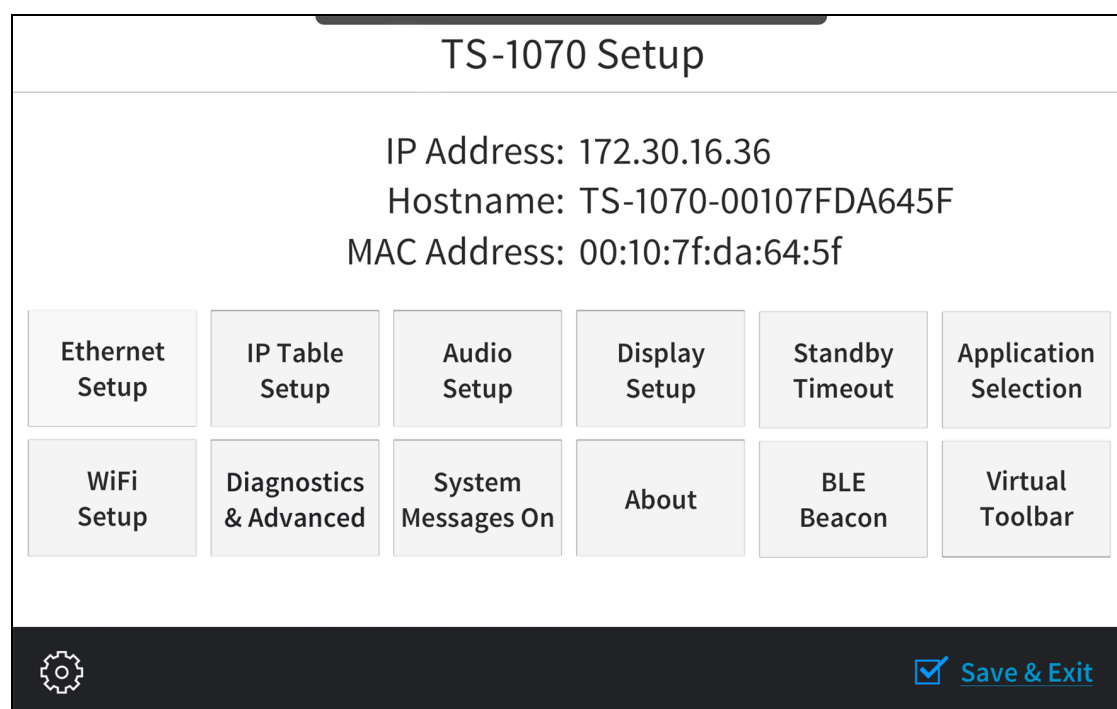

Device settings for the touch screen may be configured using the built-in setup screens or the web configuration interface.

- To configure the device using the built-in setup screens, refer to [Local Configuration on page 82](#).
- To configure the device using the web configuration interface, refer to [Web Configuration on page 120](#).

Local Configuration

Refer to the following sections for information about configuring the device locally using its built-in setup screens.

Access the Setup Screens

The setup screens enable basic configuration prior to regular operation of the touch screen.

To access the touch screen's built-in setup screens during regular operation, place five fingers on the display and hold for 15 seconds.

The main Setup screen is displayed (TS-1070 shown).

TS-1070 Setup Screen

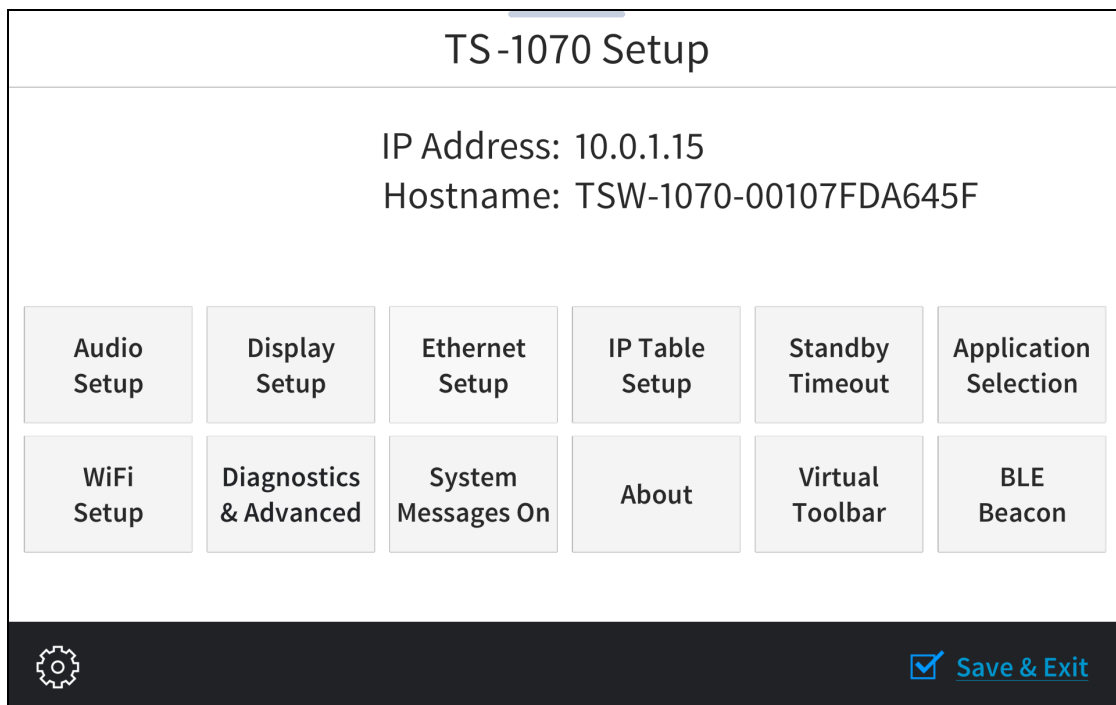

The Setup screen shows the IP address and host name of the touch screen and provides the following configuration selections:

- Buttons for Ethernet setup, IP table setup, audio setup, display setup, standby timeouts, application selection, Wi-Fi® network setup, diagnostics, Bluetooth® beacon configuration, and the virtual toolbar (model dependent).
- A button to toggle system messages on or off
- An **About** button that provides information about the touch screen.

The functions of each button are detailed in the following sections.

NOTE: A toolbar is present on the bottom of all setup screens. The toolbar provides a gear button  that may be tapped to return to the Setup screen and a **Save & Exit** button that may be tapped to save all settings, to exit the setup screens, and to return to the selected scheduling application.

Ethernet Setup

Tap **Ethernet Setup** on the Setup screen to display the **Select Network Protocol** screen.

Ethernet Setup Screen

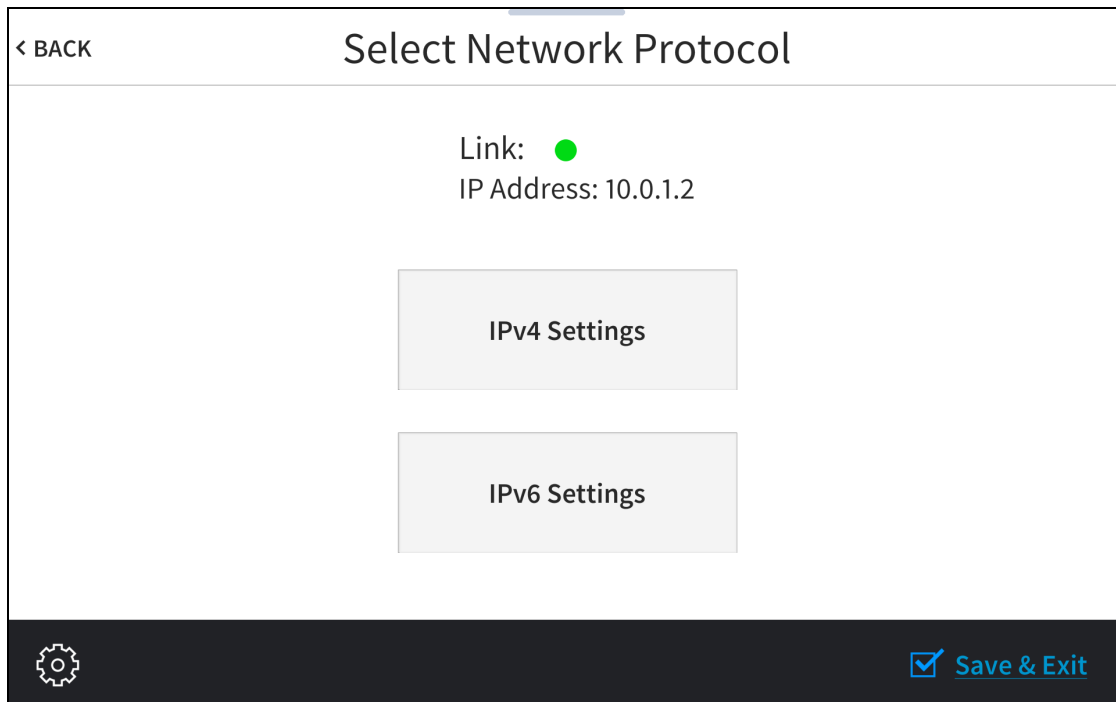

Tap **IPv4 Settings** or **IPv6 Settings** to configure IPv4 or IPv6 Ethernet settings for the touch screen, respectively.

Tap **< BACK** to return to the Setup screen.

IPv4 Settings

Tap **IPv4 Settings** on the **Select Network Protocol** screen to display the **IPv4 Ethernet Settings** screen.

IPv4 Ethernet Setup

Link: ●
MAC: 00:10:7f:da:64:00
IP Address: 10.0.1.2
Subnet Mask: 255.255.255.0
Default Router: 10.0.1.1
Primary DNS: 10.0.1.1
Secondary DNS:
Hostname: TS-1070-001
Domain: localdomain

Ethernet IP Options

Set Static IP Address Settings

DHCP Enable

On Off

Set Hostname

LAN Access

On Off

Save & Exit

Use the **IPv4 Ethernet Setup** screen to view the touch screen IPv4 MAC and IP addresses, subnet mask address, default router address, primary and secondary DNS addresses, host name, and domain. A **Link** indicator is provided to indicate the status of the IPv4 Ethernet connection. (Green indicates that the Ethernet connection is active.)

The following buttons are provided for configuring IPv4 Ethernet settings:

- Tap **On** or **Off** under **LAN Access** to turn the IPv4 Ethernet adapter on or off. If **LAN Access** is set to **Off**, IPv4 Ethernet will not function and a Wi-Fi connection can be established.
- Tap **On** or **Off** under **DHCP Enable** to turn DHCP (Dynamic Host Configuration Protocol) on or off.

NOTE: DHCP is turned on by default.

- If DHCP is turned off, tap **Set Static IP Address Settings** to enter static IPv4 addresses manually.
- Tap **Set Hostname** to enter a new touch screen host name using an on-screen keyboard.
- Tap **APPLY CHANGES** to apply any new IPv4 Ethernet settings to the touch screen and to stay in setup mode.
- Tap **REBOOT** to exit setup mode and restart the touch screen.

To change a static IPv4 address, tap **Off** under **DHCP Enable**. Then, tap **Set Static IP Address Settings** to display the **IPv4 Static IP Setup** screen.

IPv4 Static IP Setup Screen

< BACK APPLY CHANGES REBOOT

IPv4 Static IP Setup

Touch a Setting to Edit

Static IP address <input type="text" value="0.0.0.0"/>	Preferred DNS <input type="text" value="0.0.0.0"/>
Static Subnet Mask <input type="text" value="0.0.0.0"/>	Alternate Preferred DNS <input type="text" value="0.0.0.0"/>
Static Default Router <input type="text" value="0.0.0.0"/>	



 [Save & Exit](#)

To edit the static IP address, the static subnet mask, the static default router, the preferred DNS, or the alternate preferred DNS, tap the text field underneath the setting name.



The on-screen numeric keypad opens for the chosen setting.

Edit IP Address On-Screen Numeric Keypad

< CANCEL Edit IP Address

1	2	3
4	5	6
7	8	9
.	0	Save

- Use the keypad to make a new entry.
- Tap the clear button  in the text field to clear any previous entry.
- Tap the delete button  to delete the last digit.
- Tap **Save** to save a new entry or tap **< CANCEL** to discard any changes. The display returns to the **IPv4 Static IP Setup** screen.

After new settings have been saved, tap **APPLY CHANGES** on the **IPv4 Static IP Setup** screen to apply the new settings and stay in setup mode. Tap **REBOOT** to exit setup mode and restart the touch screen.

Tap **< BACK** to return to the **IPv4 Ethernet Setup** screen.

Tap **< BACK** on the **IPv4 Ethernet Setup** screen to return to the **Select Network Protocol** screen.

IPv6 Settings

Tap **IPv6 Settings** on the **Select Network Protocol** screen to display the **IPv6 Ethernet Settings** screen.

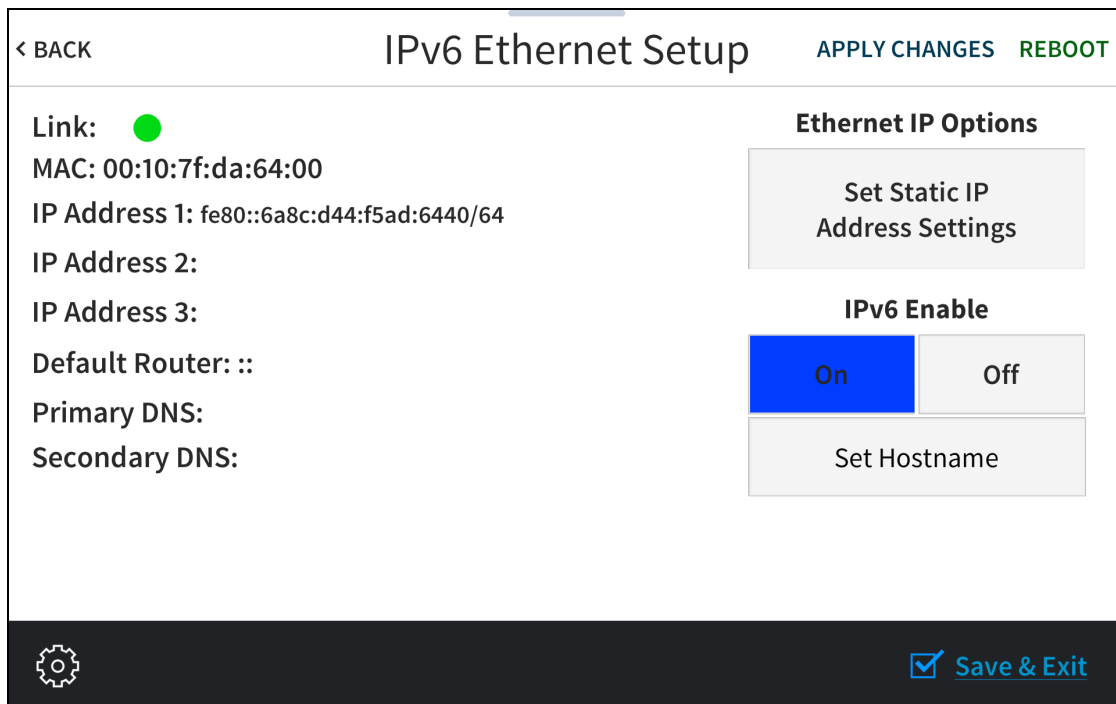

The screenshot displays the **IPv6 Ethernet Setup** interface. At the top, there is a navigation bar with a **< BACK** button on the left, the title **IPv6 Ethernet Setup** in the center, and **APPLY CHANGES** and **REBOOT** buttons on the right. The main content area is divided into two columns. The left column contains the following fields: **Link:** with a green dot indicator; **MAC:** 00:10:7f:da:64:00; **IP Address 1:** fe80::6a8c:d44:f5ad:6440/64; **IP Address 2:**; **IP Address 3:**; **Default Router:** ::; **Primary DNS:**; and **Secondary DNS:**. The right column contains three sections: **Ethernet IP Options** with a button for **Set Static IP Address Settings**; **IPv6 Enable** with two buttons, **On** (highlighted in blue) and **Off**; and a button for **Set Hostname**. At the bottom of the screen, there is a dark bar with a gear icon on the left and a **Save & Exit** button with a checkmark icon on the right.

Use the **IPv6 Ethernet Setup** screen to view the touch screen IPv6 MAC and IP addresses, default router address, and primary and secondary DNS addresses. A **Link** indicator is provided to indicate the status of the IPv6 Ethernet connection. (Green indicates that the Ethernet connection is active.)

The following buttons are provided for configuring IPv6 Ethernet settings:

- Tap **On** or **Off** under **IPv6 Enable** to turn IPv6 addressing on or off.
- Tap **Set Static IP Address Settings** to enter static IPv6 addresses manually.

- Tap **Set Hostname** to enter a new touch screen host name using an on-screen keyboard.
- Tap **APPLY CHANGES** to apply any new IPv6 Ethernet settings to the touch screen and to stay in setup mode.
- Tap **REBOOT** to exit setup mode and restart the touch screen.

To change a static IPv6 address, tap **Set Static IP Address Settings** to display the **IPv6 Static IP Setup** screen.

IPv6 Static IP Setup Screen



The screenshot shows the 'IPv6 Static IP Setup' screen. At the top left is a '< BACK' button. The title 'IPv6 Static IP Setup' is centered. To the right are 'APPLY CHANGES' and 'REBOOT' buttons. Below the title bar is a blue prompt 'Touch a Setting to Edit'. There are four text input fields: 'Static IP address', 'Preferred DNS', 'Static Default Router', and 'Alternate Preferred DNS'. At the bottom left is a gear icon, and at the bottom right is a 'Save & Exit' button with a checkmark icon.

To edit the static IP address, the static default router, the preferred DNS, or the alternate preferred DNS, tap the text field underneath the setting name.

The on-screen numeric keypad opens for the chosen setting.

Edit IPv6 Address On-Screen Numeric Keypad

The screenshot shows the 'Edit IPv6 Address' interface. At the top left is a '< CANCEL' button. The title 'Edit IPv6 Address' is centered at the top. Below the title is a text input field with a clear button (X) and a delete button (X with a left arrow). Underneath the text field is a numeric keypad with two rows. The first row contains digits 1 through 0. The second row contains a colon (:), lowercase letters a through f, and a forward slash (/). At the bottom center of the screen is a green 'Save' button.

- Use the keypad to make a new entry.
- Tap the clear button  in the text field to clear any previous entry.
- Tap the delete button  to delete the last digit.
- Tap **Save** to save a new entry or tap < **CANCEL** to discard any changes. The display returns to the **IPv6 Static IP Setup** screen.

After new settings have been saved, tap **APPLY CHANGES** on the **IPv6 Static IP Setup** screen to apply the new settings and stay in setup mode. Tap **REBOOT** to exit setup mode and restart the touch screen.

Tap < **BACK** to return to the **IPv6 Ethernet Setup** screen.

Tap < **BACK** on the **IPv6 Ethernet Setup** screen to return to the **Select Network Protocol** screen.

IP Table Setup

Tap **IP Table Setup** on the Setup screen to display the **Ethernet Setup - IP Table** screen.

Ethernet Setup - IP Table Screen

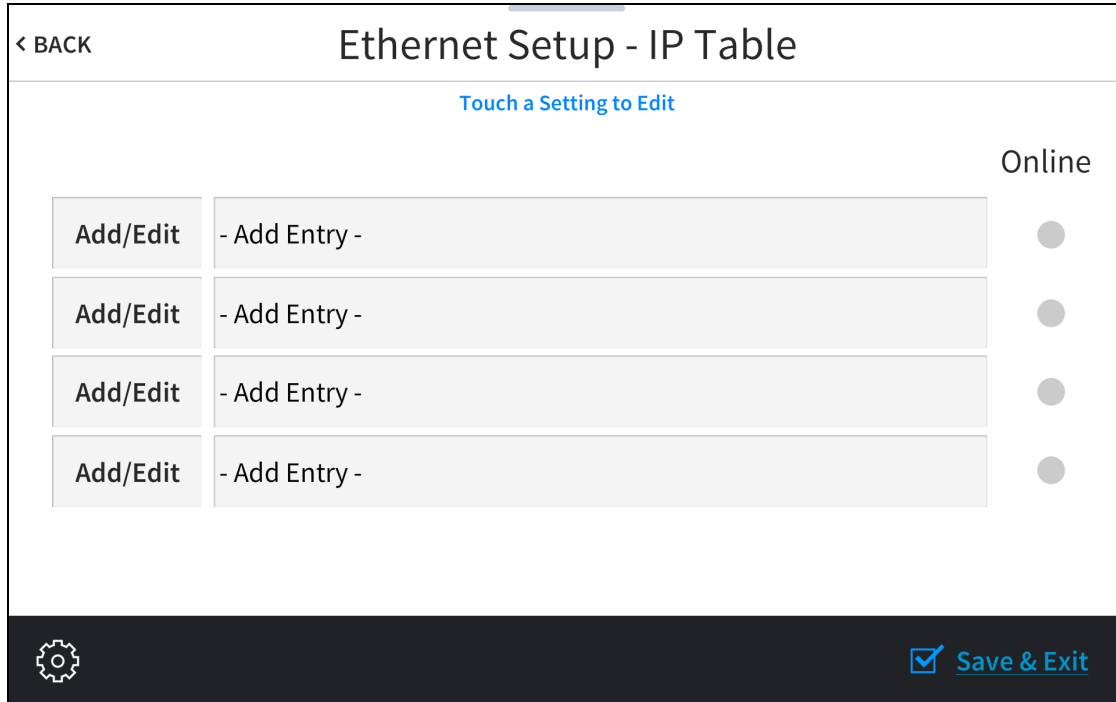

Use the **Ethernet Setup - IP Table** screen to view and edit the IP table settings for connecting the touch screen to a control system. The **Ethernet Setup - IP Table** screen also provides an **Online** indicator for each IP table entry. (Green indicates that the control system is online.)

To add or edit an entry, tap **Add/Edit** next to the corresponding entry. The **Ethernet Setup - Edit IP Table** screen is displayed.

Ethernet Setup - Edit IP Table Screen

< BACK Ethernet Setup - Edit IP Table

Touch a Setting to Edit

CIP ID	IP Address / Hostname	Port
3		41794

SAVE DELETE

Save & Exit

Tap the **CIP ID** text field to display the on-screen hex keypad.



On-Screen Hex Keypad

< CANCEL Edit CIP ID

3

1	2	3	4
5	6	7	8
9	A	B	C
D	E	F	0



SAVE

- Use the keypad to make the new entry.
- Tap the clear button  in the text field to clear any previous entry.
- Tap the delete button  to delete the last digit.
- Tap **SAVE** to save a new entry or tap **< CANCEL** to discard any changes. The display returns to the **Ethernet Setup - Edit IP Table** screen.

On the **Ethernet Setup - Edit IP Table** screen, tap the **IP Address / Hostname** text field to display an on-screen keyboard.

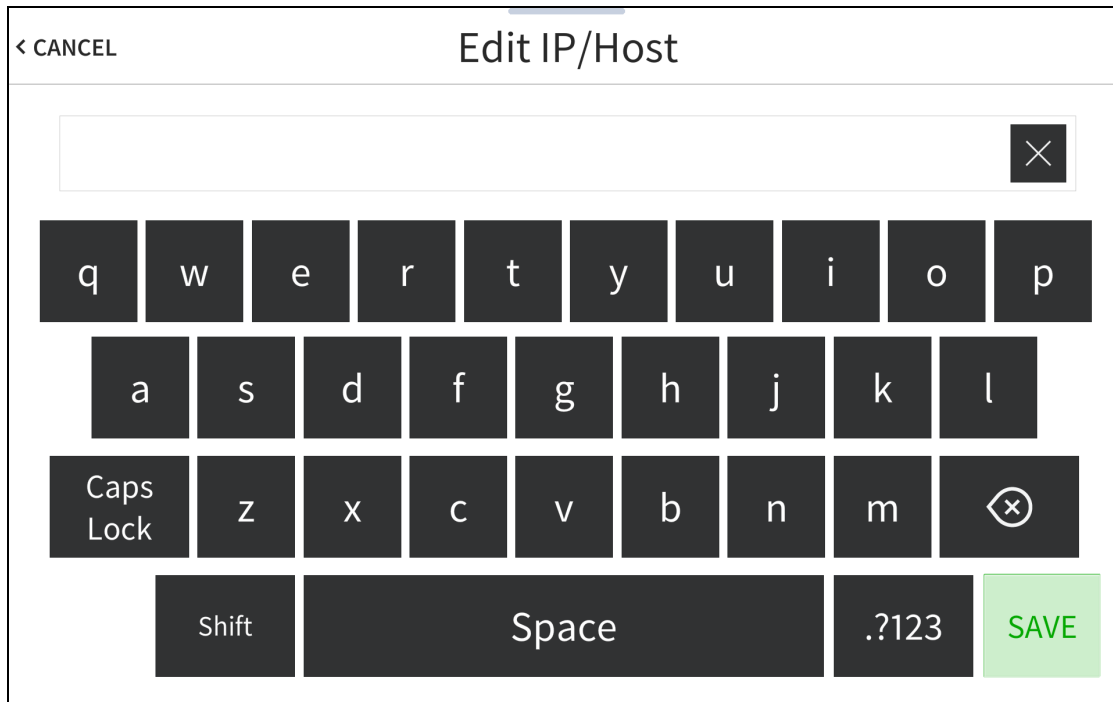
On-Screen Keyboard



- Use the keyboard to make the new entry.
- Tap the clear button  in the text field to clear any previous entry.
- Tap the delete button  to delete the last digit.
- Tap **SAVE** to save a new entry or tap **< CANCEL** to discard any changes. The display returns to the **Ethernet Setup - Edit IP Table** screen.

Tap **< BACK** on the **Ethernet Setup - Edit IP Table** screen to return to the **Ethernet Setup - IP Table** screen.

Tap **< BACK** on the **Ethernet Setup - IP Table** screen to return to the Setup screen

Audio Setup

Tap **Audio Setup** on the Setup screen to display the **Audio Setup** screen.

Audio Setup Screen

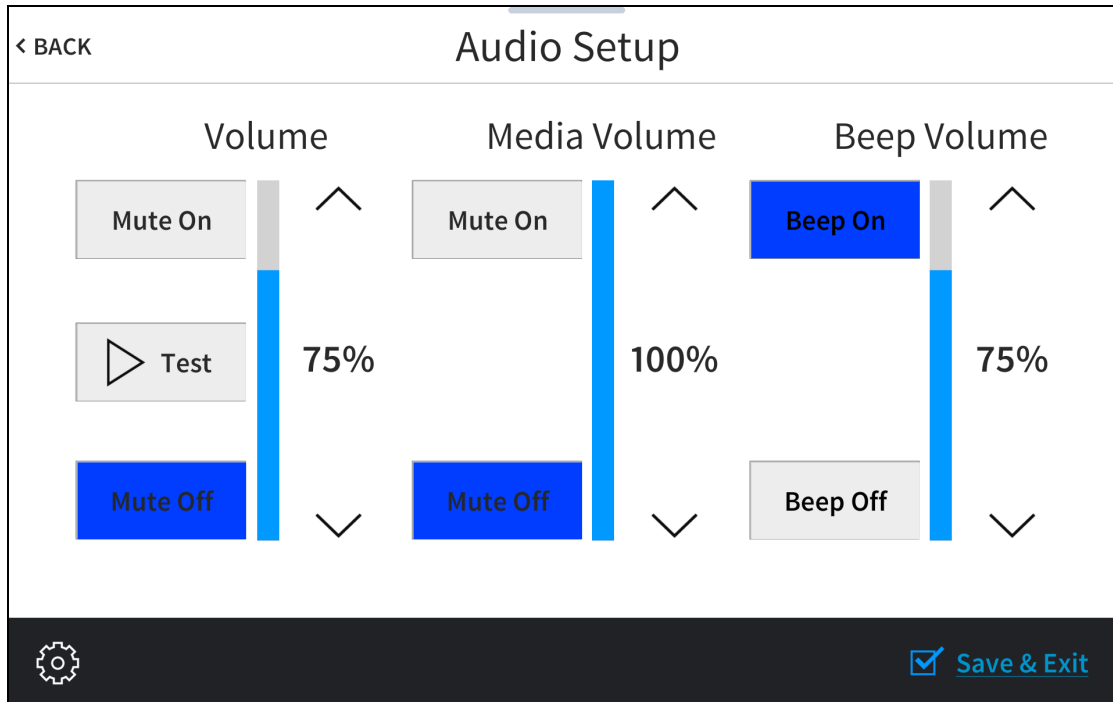

Use the **Audio Setup** screen to control the main volume, media volume, and beep volume settings for the touch screen.

NOTE: The **Media Volume** controls adjust the H.264 streaming media level in relation to the **Volume** controls.

- **Volume**
 - Tap the up and down arrow buttons to raise or lower the main touch screen volume incrementally from 0 to 100%.
 - Tap **Mute On** or **Mute Off** to mute or unmute the main volume.
 - Tap **Test** to play a test recording at the current volume level.
- **Media Volume**
 - Tap the up and down arrow buttons to raise or lower the touch screen media volume incrementally from 0 to 100%.
 - Tap **Mute On** or **Mute Off** to mute or unmute the media volume.
- **Beep Volume**
 - Tap the up and down arrow buttons to raise or lower the touch screen beep volume

incrementally from 0 to 100%.

- Tap **Beep On** or **Beep Off** to turn the beep volume on or off.

Tap **< BACK** to return to the Setup screen.

Display Setup

Tap **Display Setup** on the Setup screen to display the **Display Setup** screen.

Display Setup Screen

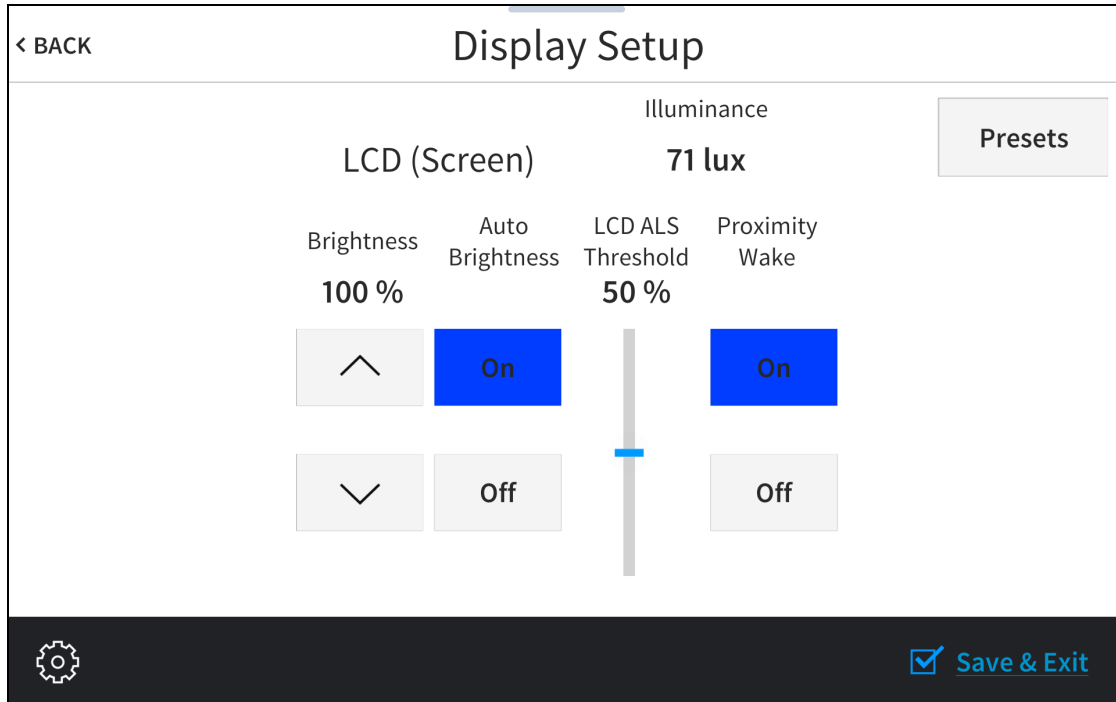

- The value shown under **Illuminance** represents the units of light (in lux) that are received by the touch screen. This value changes in real time depending on the light received by the touch screen.
- Tap the up or down arrow buttons under **Brightness** to raise or lower the LCD display brightness level incrementally from 0 to 100%.
- Tap **On** or **Off** under **Auto Brightness** to turn automatic brightness on or off for the display.
- Drag the slider up and down under **LCD ALS Threshold** to adjust the ALS (ambient light sensor) threshold value for switching between high and low autobrightness presets on the LCD display.
- Tap **On** or **Off** under **Proximity Wake** to turn proximity waking on or off for the display. When proximity waking is on, the touch screen will wake from standby automatically when a user gets within proximity of the touch screen.

Tap **Presets** to access the **Display High / Low Settings** screen.

Display High / Low Settings Screen

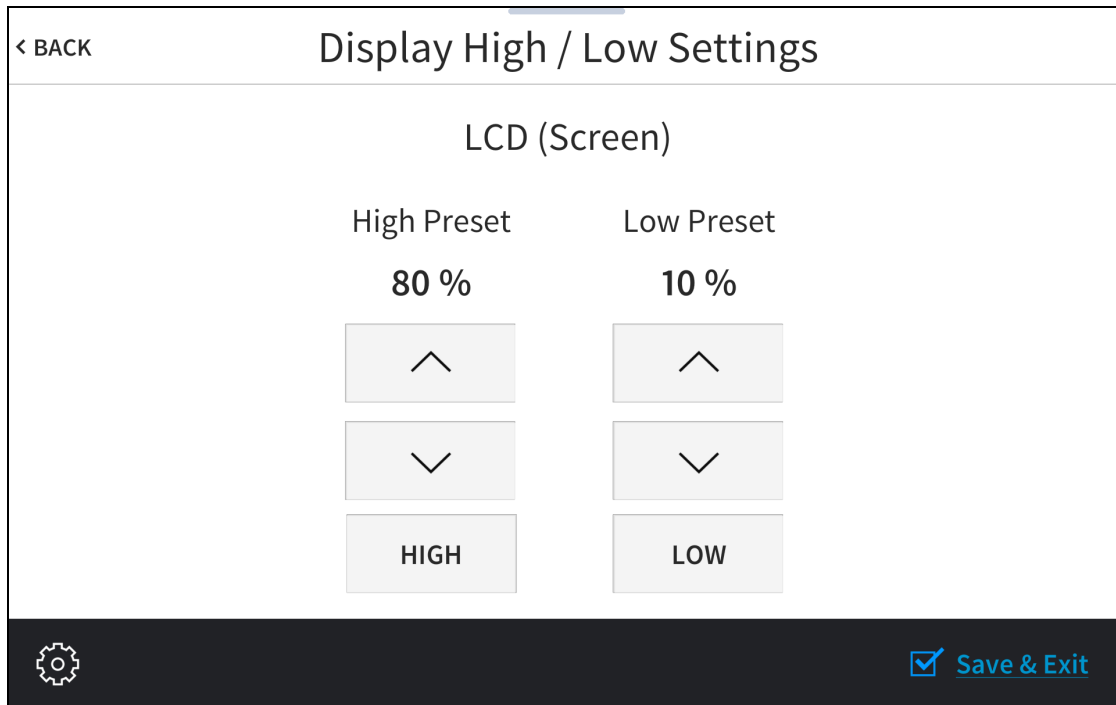

Use the **Display High / Low Settings** screen to adjust the brightness values for the touch screen display and key backlight.

- Tap the up and down arrows to raise or lower the values of the high and low brightness settings for the LCD display from 0 to 100%.
- Tap **Low** or **High** to set the brightness level to low or high, respectively, for the LCD display.

Tap **< BACK** to return to the **Display Setup** screen.

Tap **< BACK** on the **Display Setup** screen to return to the Setup screen.

Standby Timeout

Tap **Standby Timeout** on the Setup screen to display the **Standby Timeout** screen.

Standby Timeout Screen

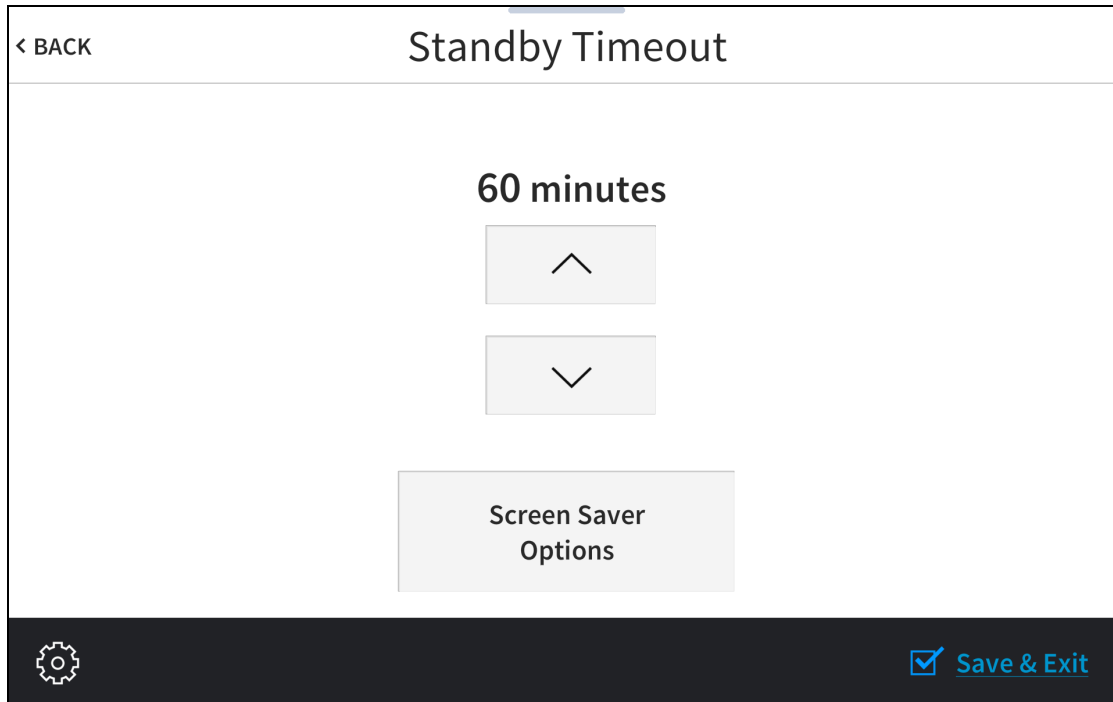

Use the **Standby Timeout** screen to set the standby timeout settings for the touch screen.

Tap the up and down arrow buttons to increase the touch screen standby timeout duration from 0 to 120 minutes.

Tap **Screen Saver Options** to display the **Standby Screensaver** screen.

Standby Screensaver Screen

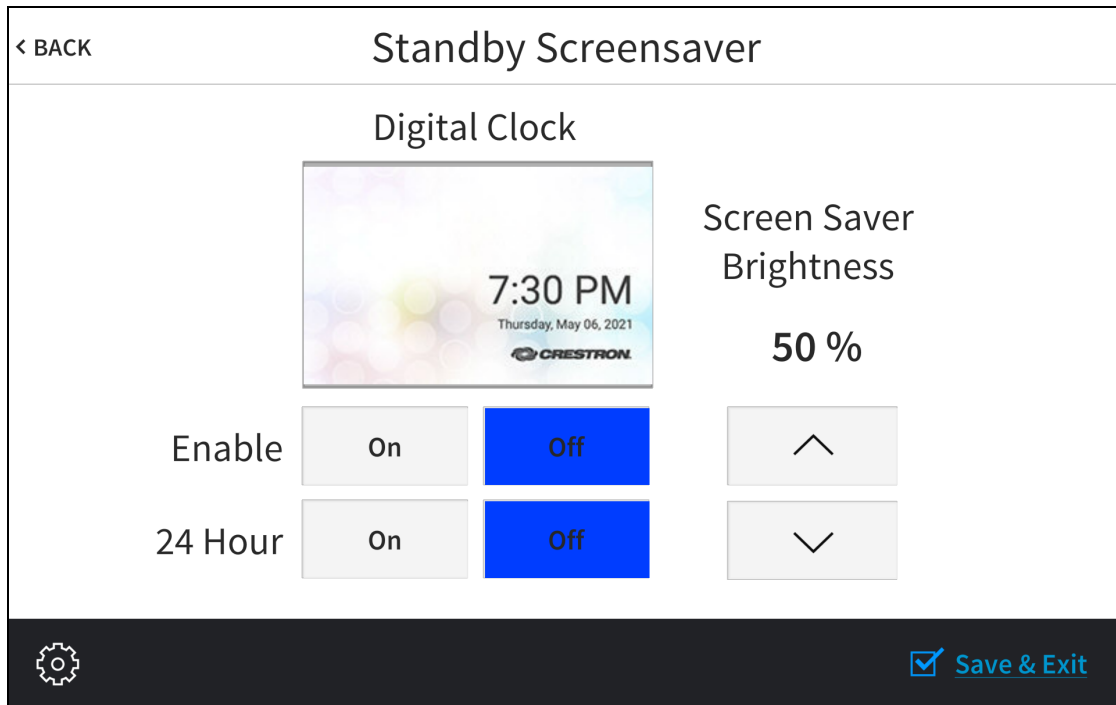

- Tap **On** or **Off** next to **Enable** to turn the digital clock screensaver on or off during standby timeout
- Tap **On** or **Off** next to **24 Hour** to turn 24-hour time format on or off for the digital clock.
- Tap the up and down arrow buttons under **Screen Saver Brightness** to increase or decrease the screensaver brightness from 0 to 100%.

Tap **< BACK** to return to the **Standby Timeout** screen.

Tap **< BACK** on the **Standby Timeout** screen to return to the Setup screen.

Application Selection

Tap **Application Selection** on the Setup screen to display the **Application Setup** screen.

Application Setup Screen

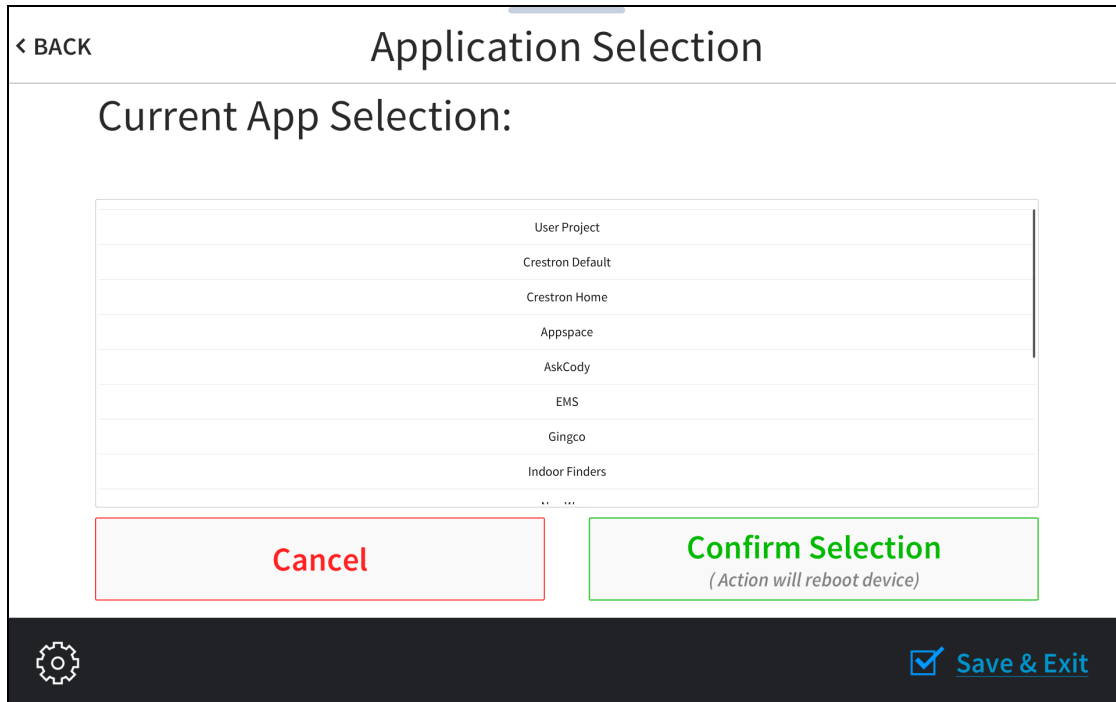

Use the **Application Selection** screen to select a touch screen application from the available selections. **User Project** is selected by default, which is used when a custom project is loaded to the touch screen. Swipe up or down through the list, and then tap an application to select it. Tap **Confirm Selection** to confirm the selection or tap **Cancel** to return to the previous screen. Once confirmed, the touch screen restarts with the new application running.

NOTE: Each application uses a unique setup procedure for registering and configuring the application. For more information on setting up each application, refer to [Application Selection on page 162](#).

Tap **< BACK** to return to the Setup screen.

Wi-Fi Setup

Tap **Wi-Fi Setup** on the Setup screen to display the **Wi-Fi Setup** screen.

Wi-Fi Setup Screen

The screenshot shows the 'WiFi Setup' screen with a title bar containing '< BACK', 'WiFi Setup', 'APPLY CHANGES', and 'REBOOT'. The screen is divided into two main sections. The left section displays network status and configuration details: 'Link' with a green indicator, 'WiFi MAC: 00:00:00:00:00:00', 'IP Address: 10.0.255.0', 'Subnet Mask: 255.255.255.0', 'Default Router: 10.0.1.0', 'Primary DNS: 10.0.1.0', 'Secondary DNS:', 'Hostname: TS-1070-001', 'Domain: localdomain', 'SSID: Ham1', 'BSSID: b8:c7:5d:07:f7:b8', and 'Radio Band: G'. The right section contains 'WiFi IP Options' with a 'Set Static IP Address Settings' button, 'DHCP Enable' with 'On' and 'Off' toggle buttons, 'Set Hostname', 'Select WiFi Access Point', and 'Manage WiFi Access Points'. At the bottom right, there is a 'WiFi Access' section with 'On' and 'Off' toggle buttons. A 'Save & Exit' button with a checkmark icon is located at the bottom right of the screen.

Use the **Wi-Fi Setup** screen to view the Wi-Fi network MAC and IP addresses, subnet mask address, default router address, primary and secondary DNS addresses, host name, domain, and various details about the Wi-Fi connection. A **Link** indicator is provided to indicate the status of the Wi-Fi connection. (Green indicates that the Wi-Fi connection is active.)

NOTE: Ethernet must be disabled before a Wi-Fi connection can be configured.

The following buttons are provided for configuring Wi-Fi settings:

- Tap **On** or **Off** under **Wi-Fi Access** to turn the Wi-Fi adapter on or off. If **Wi-Fi Access** is set to **Off**, Wi-Fi will not function and an Ethernet connection can be established.
- Tap **On** or **Off** under **DHCP Enable** to turn DHCP (Dynamic Host Configuration Protocol) on or off.

NOTE: DHCP is enabled on the touch screen by default.

- If DHCP is turned off, tap **Set Static IP Address Settings** to enter static IP addresses manually.
- Tap **Set Hostname** to enter a new touch screen host name using an on-screen keyboard.

- Tap **APPLY CHANGES** to apply any new Wi-Fi settings to the touch screen and to stay in setup mode.
- Tap **REBOOT** to exit setup mode and restart the touch screen.

To change a static IP address, tap **Off** under **DHCP Enable**. Then, tap **Set Static IP Address Settings** to display the **Wi-Fi Static IP Setup** screen.

Wi-Fi Static IP Setup Screen



The screenshot shows the 'WiFi Static IP Setup' screen. At the top left is a '< BACK' button. The title 'WiFi Static IP Setup' is centered. To the right are 'APPLY CHANGES' and 'REBOOT' buttons. Below the title bar is a blue prompt 'Touch a Setting to Edit'. The main area contains five text input fields: 'Static IP address', 'Preferred DNS', 'Static Subnet Mask', 'Alternate Preferred DNS', and 'Static Default Router', each with '0.0.0.0' entered. At the bottom, there is a gear icon on the left and a 'Save & Exit' button with a checkmark icon on the right.

To edit the static IP address, the static subnet mask, the static default router, the preferred DNS, or the alternate preferred DNS, tap the text field underneath the setting name.

The on-screen numeric keypad opens for the chosen setting.

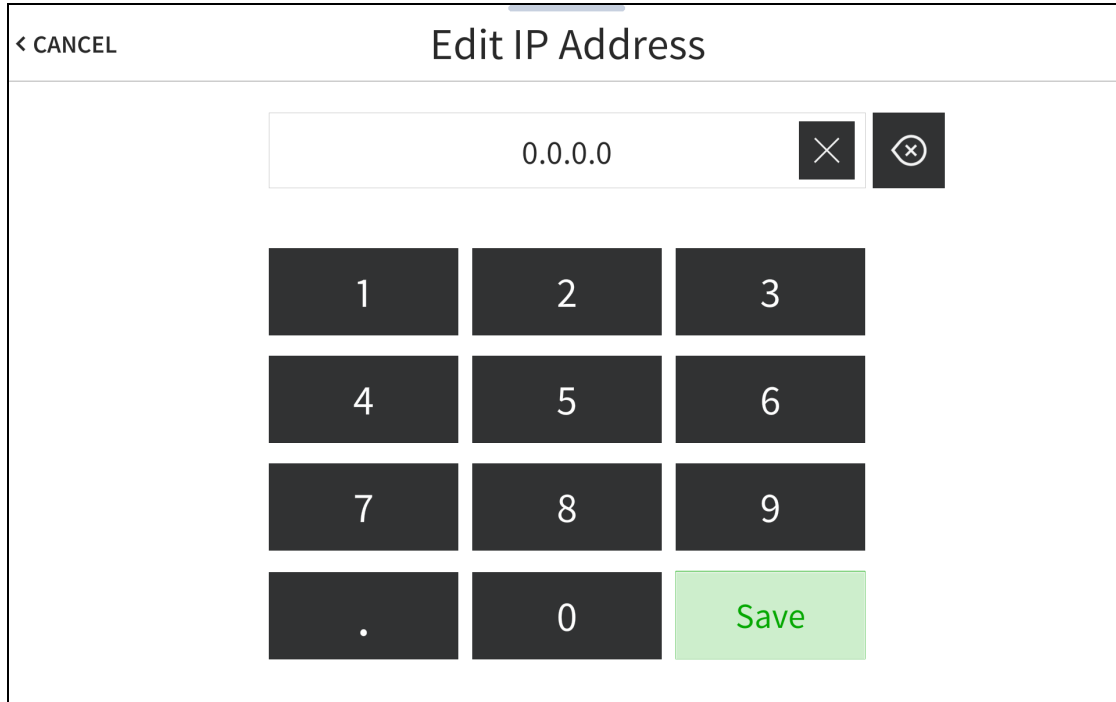
Edit IP Address On-Screen Numeric Keypad



- Use the keypad to make a new entry.
- Tap the clear button  in the text field to clear any previous entry.
- Tap the delete button  to delete the last digit.
- Tap **Save** to save a new entry or tap **< CANCEL** to discard any changes. The display returns to the **Static IP Ethernet Setup** screen.

After new settings have been saved, tap **APPLY CHANGES** on the **WiFi Static IP Setup** screen to apply the new settings and stay in setup mode. Tap **REBOOT** to exit setup mode and restart the touch screen.

Tap **< BACK** to return to the **Wi-Fi Setup** screen.

Tap **< BACK** on the **Wi-Fi Setup** screen to return to the Setup screen.

Select a Wi-Fi Access Point

On the **Wi-Fi Setup** screen, tap **Select Wi-Fi Access Point**. The **Connect to a Wi-Fi Access Point (1-2-3)** screen is displayed.

Connect to a Wi-Fi Access Point (1-2-3) Screen

< BACK **Connect to a WiFi Access Point (1-2-3)**

Step 1 - Select a WAP

Add new...

lan's Guest Network

(Updates within 30 seconds)

Step 2 - Touch to Edit WAP Settings

WAP Name (SSID):

Security:

Open

Password:

Step 3 - Make this my Access Point

Save & Exit

Use the **Connect to a Wi-Fi Access Point (1-2-3)** screen to connect the touch screen to an existing WAP that is in range or to configure a new WAP. Any WAPs that are in range and discoverable are displayed under **Step 1 - Select a WAP** upon successful discovery.

To set up a Wi-Fi network connection:

1. Select the desired WAP from the options shown underneath **Step 1 - Select a WAP**. If the desired WAP is not shown, tap **Add New**.

NOTE: The **WAP Name (SSID)** and **Security** fields are populated automatically when a discovered WAP is selected. This information must be entered manually when adding a new WAP.

2. Tap the **WAP Name (SSID)** text field to display an on-screen keyboard.
3. Enter or modify the WAP name if necessary, and then tap **SAVE**.
4. Tap the **Security** text field to display the **Wi-Fi Encryption Settings** screen.

Wi-Fi Encryption Settings

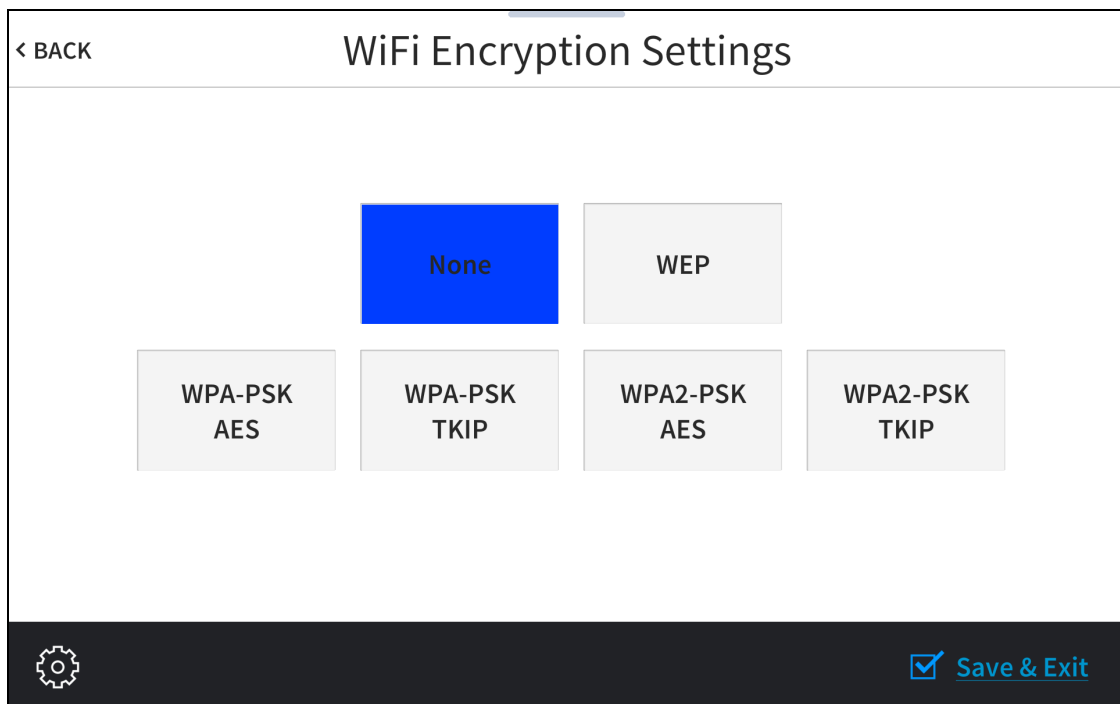

5. Tap the appropriate encryption type used by the WAP, and then tap **< BACK**.
6. Tap the **Password** text field to display an on-screen keyboard.
7. Enter the password used to connect to the WAP, and then tap **SAVE**.
8. Tap **Step 3 - Make this my Access Point**. The **Wi-Fi WAP Selection** screen is displayed.

The touch screen attempts to connect to the WAP using the provided credentials. If a connection is established, connection details for the WAP are shown with a green check mark to the left of **Current Connection**.

Wi-Fi WAP Selection Screen (Connection Successful)

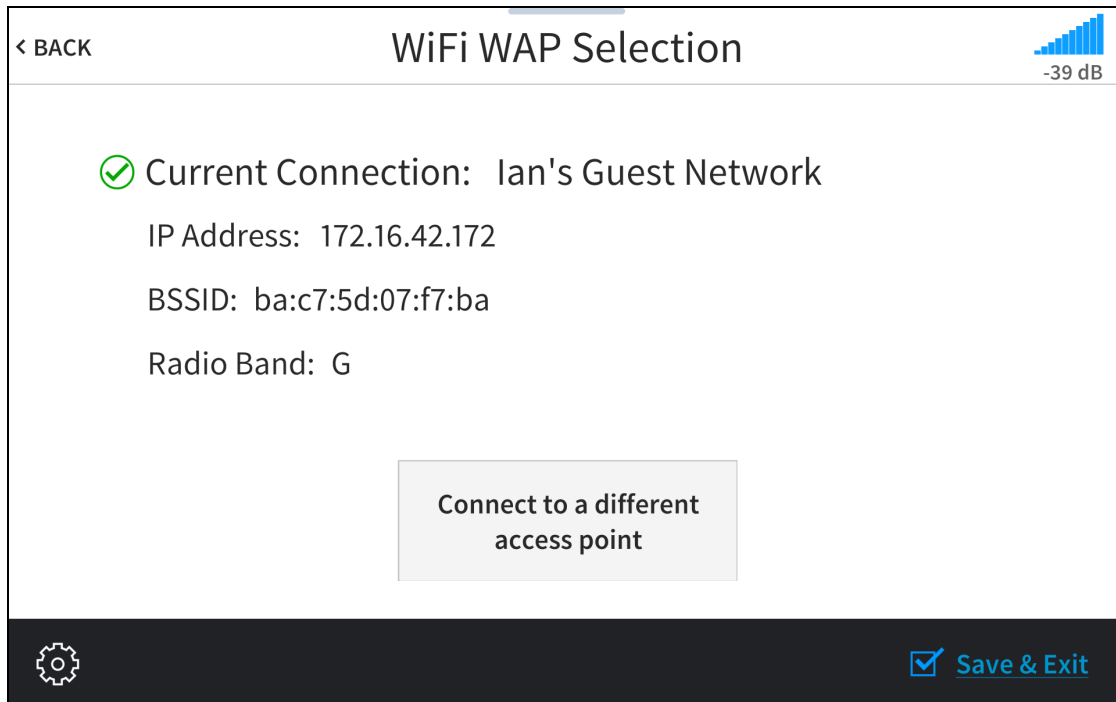

If the connection fails, a failure message is displayed. Tap **Connect to a different access point** to return to the **Connect to a Wi-Fi Access Point (1-2-3)** screen.

NOTE: If four WAPs have already been assigned, the **Wi-Fi WAP Selection** screen indicates that the WAP list is full. Tap **Delete an access point?** to display the **Manage Wi-Fi Access Points** screen, where an existing WAP may be deleted, or tap **< BACK** to cancel adding the new WAP. For more information, refer to [Manage Wi-Fi Access Points on page 104](#).

Tap **< BACK** to return to the **Wi-Fi Setup** screen.

Manage Wi-Fi Access Points

On the **Wi-Fi Setup** screen, tap **Manage Wi-Fi Access Points**. The **Manage Wi-Fi Access Points** screen is displayed.

Manage Wi-Fi Access Points Screen

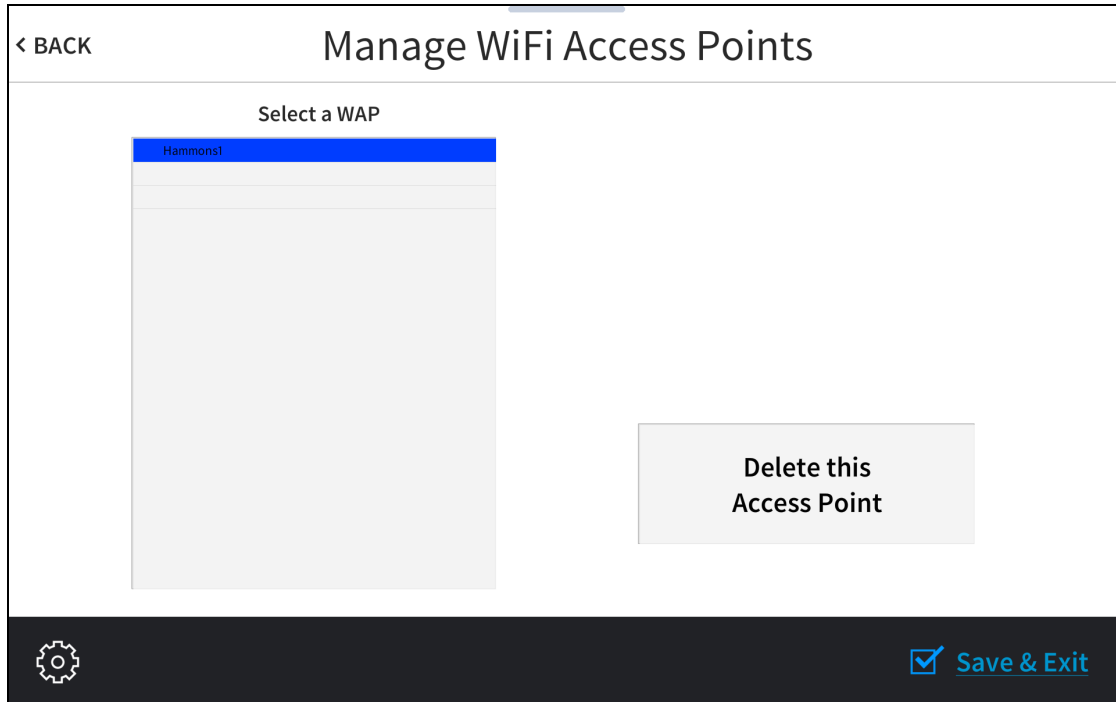

Use the **Manage Wi-Fi Access Points** screen to manage settings for up to four saved WAPs. Tap one of the listed WAPs to display controls to manage the WAP.

Tap **Delete this Access Point** to delete the selected WAP. If a WAP is deleted, it must be added back to the list using the procedures described in [Select a Wi-Fi Access Point on page 101](#).

Tap **< BACK** to return to the **Wi-Fi Setup** screen.

Bluetooth Beacon

Tap **BLE Beacon** on the Setup screen to display the **BLE Beacon** screen.

BLE Beacon Screen



Use the **BLE Beacon** screen to configure the built-in PinPoint™ proximity detection beacon. Using Bluetooth® technology, the beacon works with the Crestron App or Crestron PinPoint App to determine when a mobile device is in or near the same room as the beacon, and signals the mobile app to automatically display the appropriate controls and information for the room.

- Tap **On** or **Off** underneath **BLE Beacon** to turn the proximity beacon on or off, respectively.
- Tap **On** or **Off** underneath **Config Mode** to turn configuration mode on or off, respectively. Turning on configuration mode enables the proximity beacon to be configured.

NOTE: The proximity beacon and configuration mode cannot both be turned on at the same time.

Tap < **BACK** to return to the Setup screen.

Virtual Toolbar

Tap **Virtual Toolbar** on the Setup screen to display the **On-screen Toolbar** screen.

On-screen Toolbar Screen

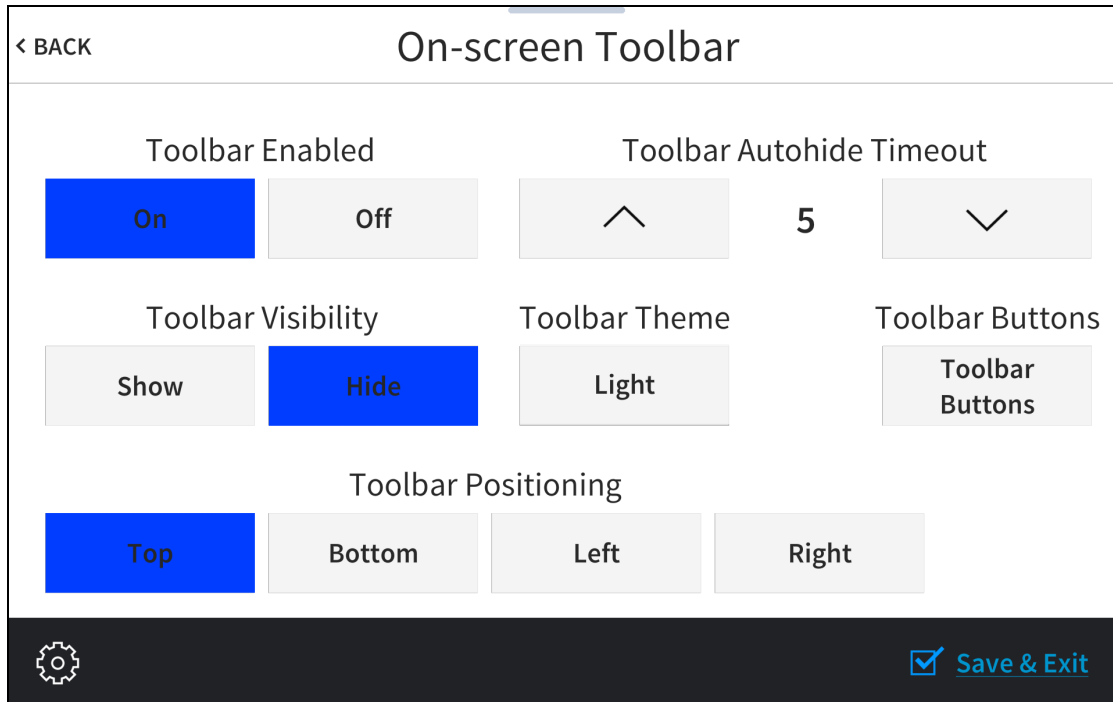

Use the **On-screen Toolbar** screen to configure settings for the virtual toolbar. By default, the virtual toolbar can be accessed by swiping down on the tab located at the top of the screen and provides virtual buttons for power, home, lighting, up, down, and microphone. The toolbar is hidden automatically after a set timeout duration.

NOTE: Virtual button functionality can be custom programmed using a Crestron control system.

On-screen Toolbar Screen (with Virtual Toolbar)

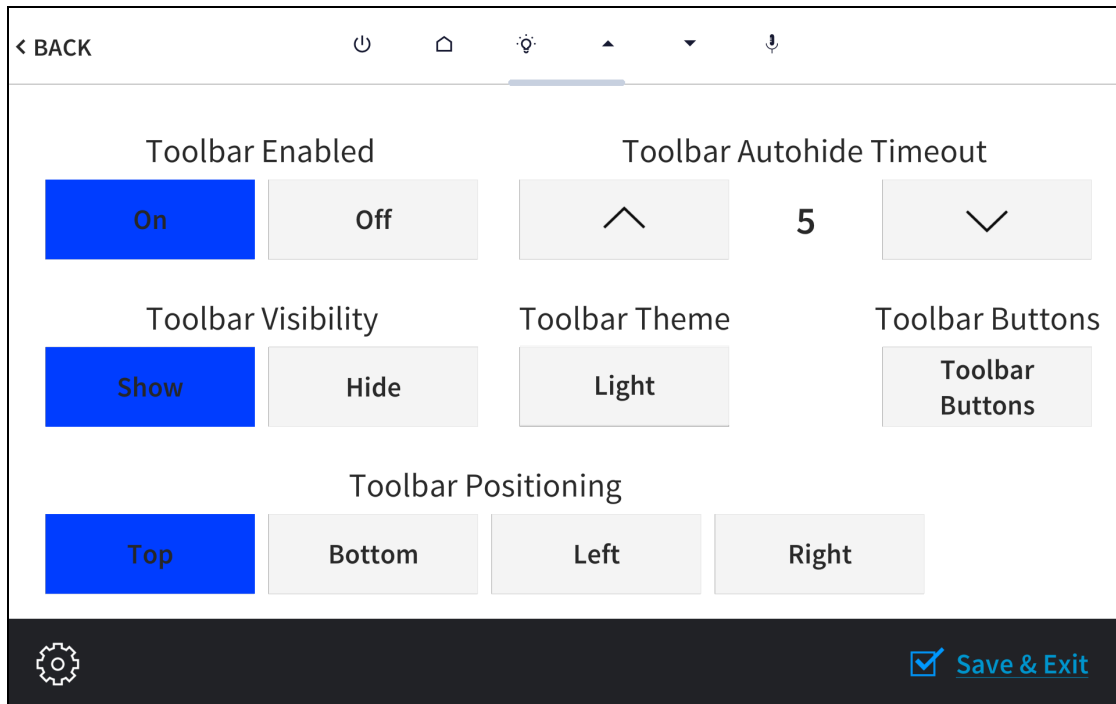

- Tap **On** or **Off** under **Toolbar Enabled** to turn the virtual toolbar on or off, respectively.
- Tap **Show** or **Hide** under **Toolbar Visibility** to have the toolbar exposed or hidden by default, respectively.
- Tap **Top**, **Bottom**, **Left**, or **Right** under **Toolbar Positioning** to place the toolbar on the respective location on the screen.
- Tap the up and down arrow buttons under **Toolbar Autohide Timeout** to increase or decrease the duration before the toolbar is automatically hidden from 0 to 600 seconds. Selecting "0" disables this behavior.
- Tap the button under **Toolbar Theme** to switch between a light and dark theme. The currently selected theme is displayed on the button.
- Tap **Toolbar Buttons** to display a screen for showing or hiding individual buttons in the virtual toolbar. Tap **On** or **Off** next to a button to show or hide the button, respectively.

On-screen Toolbar Screen - Toolbar Buttons

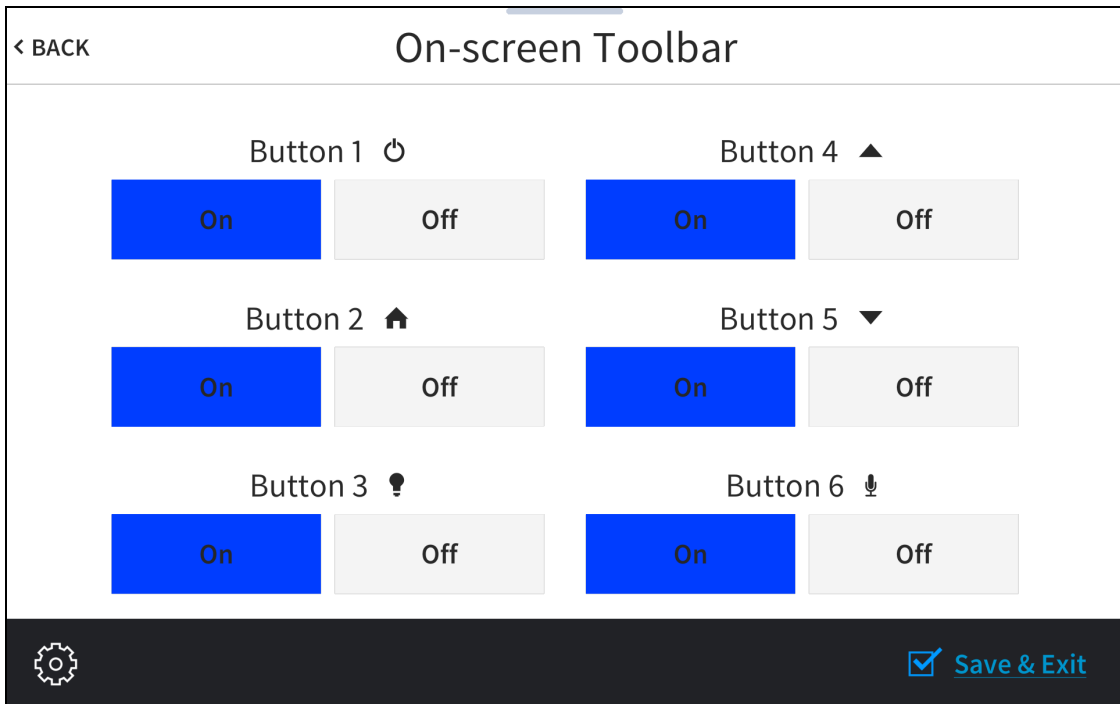

Tap < **BACK** to return to the Setup screen.

Diagnostics & Advanced

Tap **Diagnostics** on the Setup screen to display the **Diagnostics & Advanced** screen.

Diagnostics & Advanced Screen

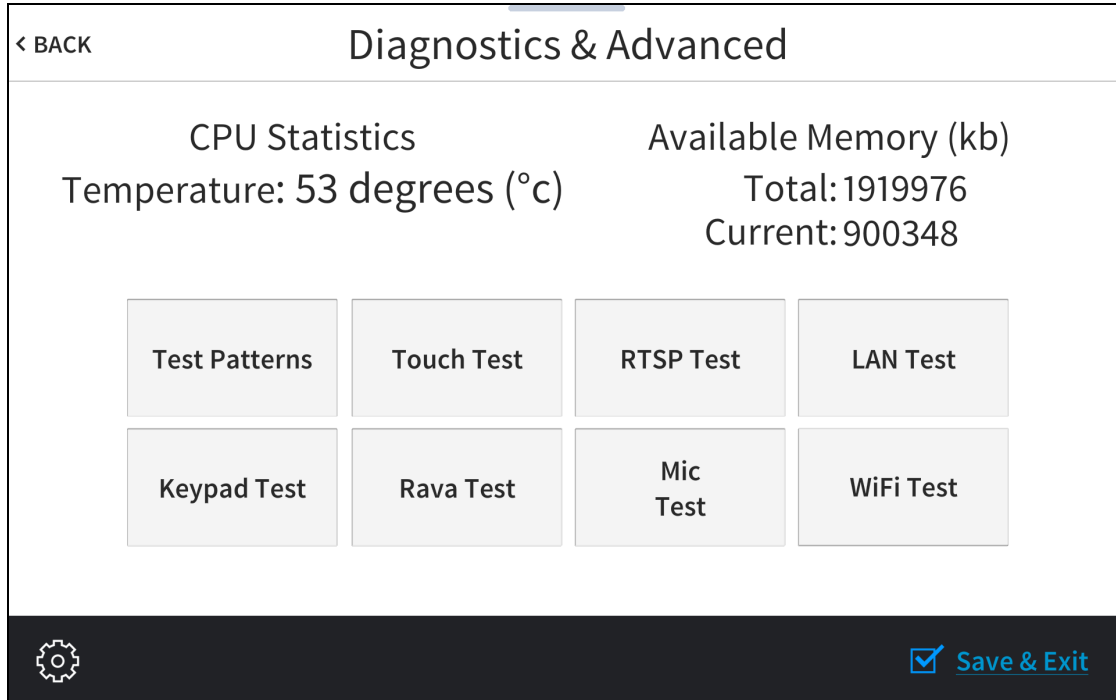

Use the **Diagnostics & Advanced** screen to access various diagnostic test screens for the touch screen. The **Diagnostics & Advanced** screen also provides the touch screen CPU temperature and available memory.

Each test screen is described in the sections that follow.

Test Patterns

Tap **Test Patterns** on the **Diagnostics & Advanced** screen to display the **Test Pattern Diagnostics** screen.

Test Pattern Diagnostics Screen

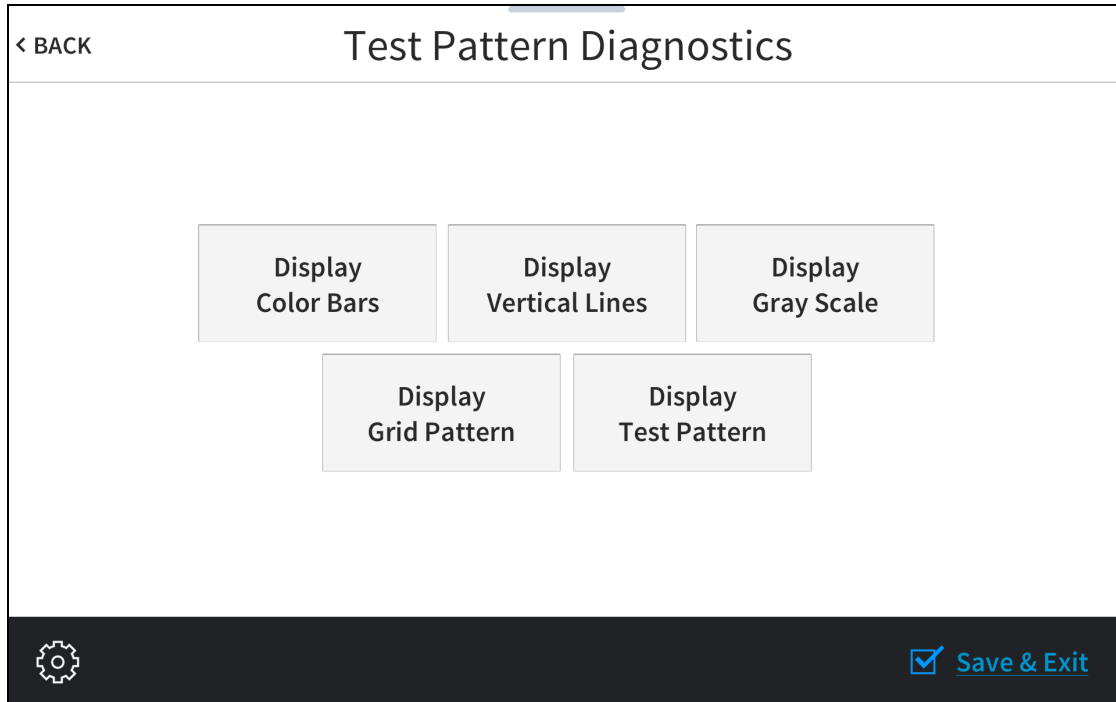

Use the **Test Pattern Diagnostics** screen to display any of the available test patterns. Tap one of the buttons on the screen to display its respective test pattern.

Tap **< BACK** to return to the **Diagnostics & Advanced** screen.

Touch Test

Tap **Touch Test** on the **Diagnostics & Advanced** screen to display the touch test screen.

Touch Test Screen

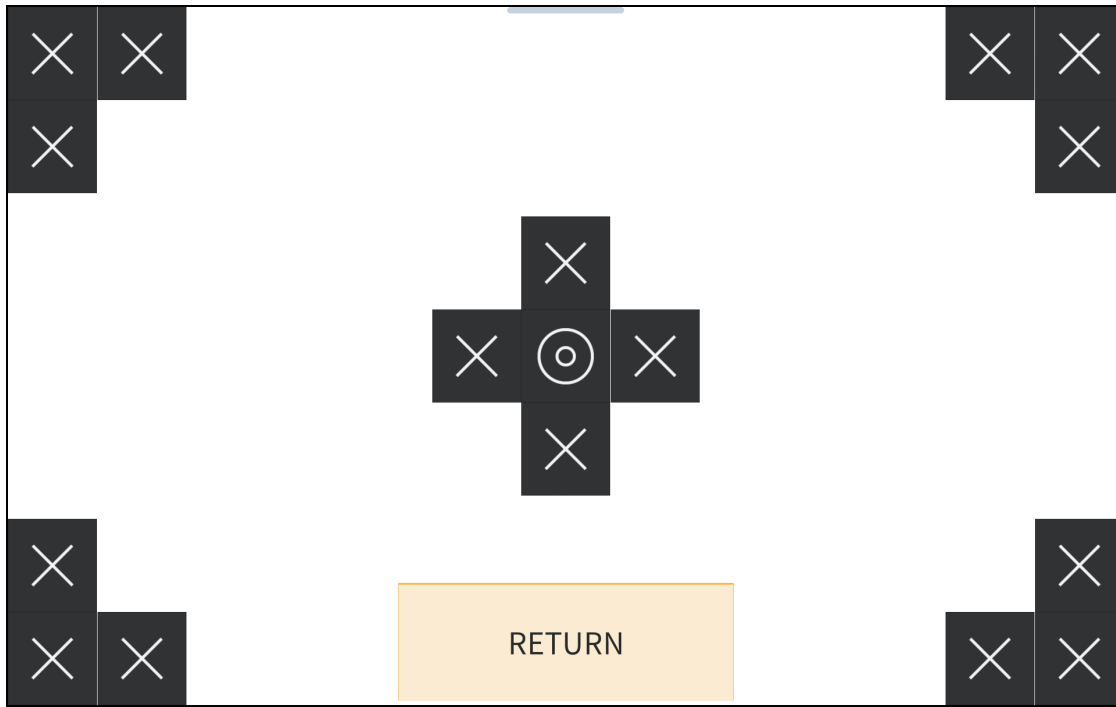

Use the touch test screen to test the touch functionality of the display. When a location button is tapped, its respective indicator lights on the screen.

Tap **RETURN** to return to the **Diagnostics & Advanced** screen.

RTSP Test

Tap **RTSP Test** on the **Diagnostics & Advanced** screen to display the **RTSP Stream Diagnostics** screen.

RTSP Stream Diagnostics Screen

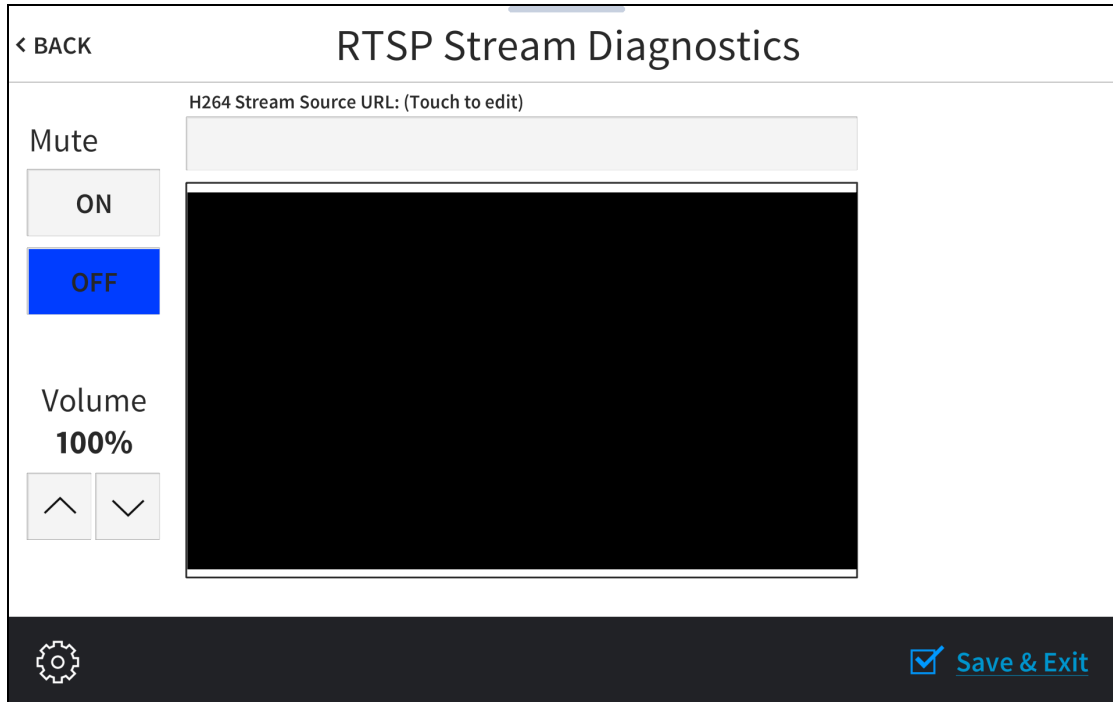

Use the **RTSP Stream Diagnostics** screen to view and test RTSP (real time streaming protocol) on the touch screen.

- Tap the text field under **H264 Stream Source URL: (Touch to edit)** to display an on-screen keyboard for entering an H.264 streaming video source URL.
- Tap the up and down arrow buttons under **Volume** to raise or lower the media volume incrementally from 0 to 100%.
- Tap **On** or **Off** under **Mute** to mute or unmute the media volume.

Tap **< BACK** to return to the **Diagnostics & Advanced** screen.

LAN Test

Tap **LAN Test** on the **Diagnostics & Advanced** screen to display the **Ethernet Diagnostics** screen.

Ethernet Diagnostics Screen

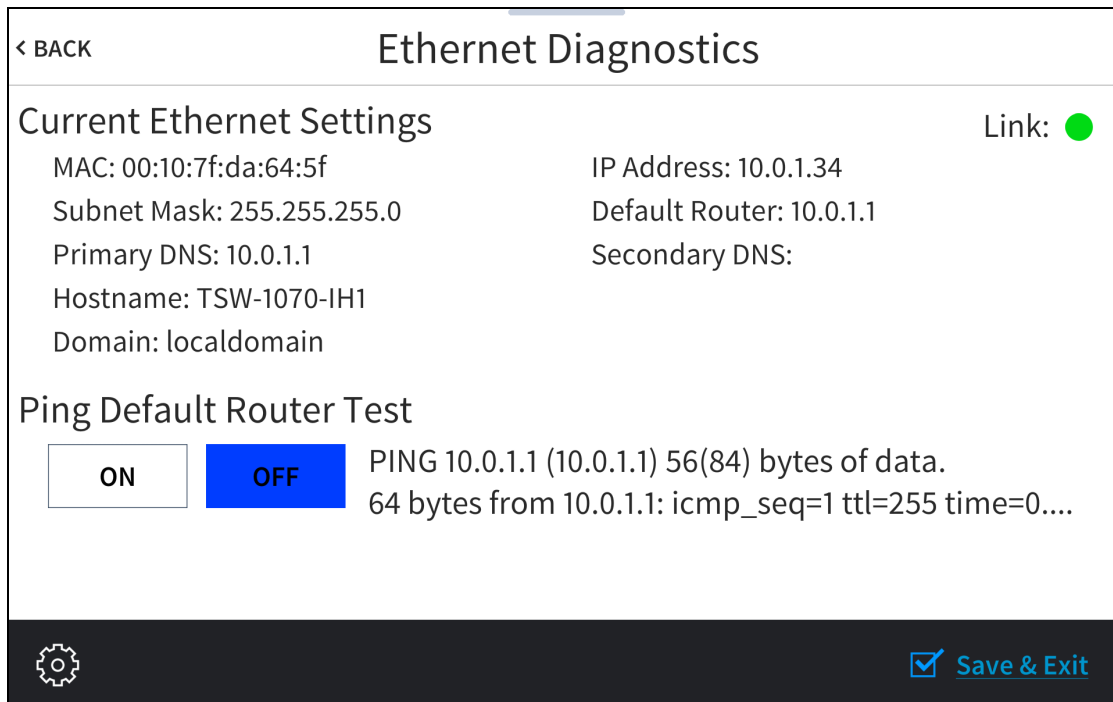

Ethernet Diagnostics

< BACK

Current Ethernet Settings Link: ●

MAC: 00:10:7f:da:64:5f IP Address: 10.0.1.34
Subnet Mask: 255.255.255.0 Default Router: 10.0.1.1
Primary DNS: 10.0.1.1 Secondary DNS:
Hostname: TSW-1070-IH1
Domain: localdomain

Ping Default Router Test

PING 10.0.1.1 (10.0.1.1) 56(84) bytes of data.
64 bytes from 10.0.1.1: icmp_seq=1 ttl=255 time=0...

 [Save & Exit](#)

Use the **Ethernet Diagnostics** screen to view and test the Ethernet connection. The Ethernet Diagnostics screen displays the touch screen MAC and IP addresses, subnet mask address, default router address, primary and secondary DNS addresses, host name, and domain name. A **Link** indicator is provided to indicate the status of the Ethernet connection. (Green indicates that the Ethernet connection is active.)

The **Ethernet Diagnostics** screen also provides controls to test the connection to the default router. Tap **On** to begin the test and **Off** to end the test.

During the router test, the touch screen pings the default router. If the router is communicating with the touch screen, connection data is displayed below the ping test controls within five seconds. The connection data updates after every successive ping.

Tap < **BACK** to return to the **Diagnostics & Advanced** screen.

Keypad Test

Tap **Keypad Test** on the **Diagnostics & Advanced** screen to display the **Keypad Diagnostics Test** screen.

Keypad Diagnostics Test Screen

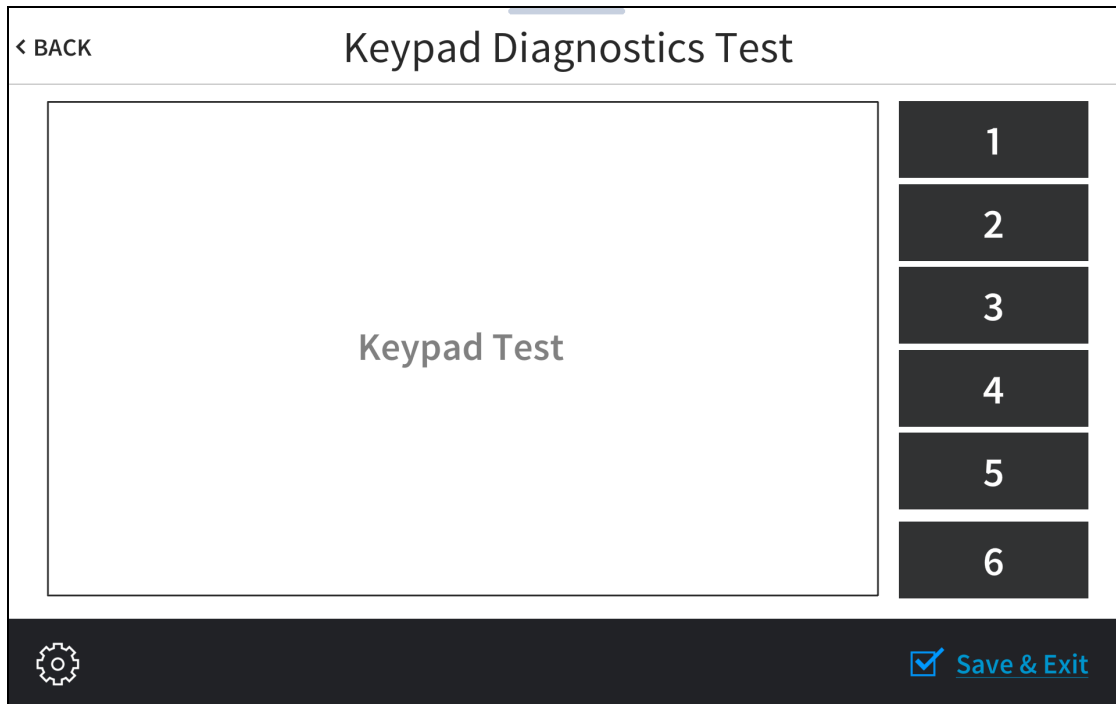

Use the **Keypad Diagnostics Test** screen to test the functionality of the six virtual toolbar buttons. When one of the virtual buttons is pressed on the touch screen, its respective indicator lights on the screen.

Tap **< BACK** to return to the **Diagnostics & Advanced** screen.

Rava® SIP Intercom

Tap **Rava Test** on the **Diagnostics & Advanced** screen to display the **Rava Diagnostics** screen.

Rava Diagnostics Screen

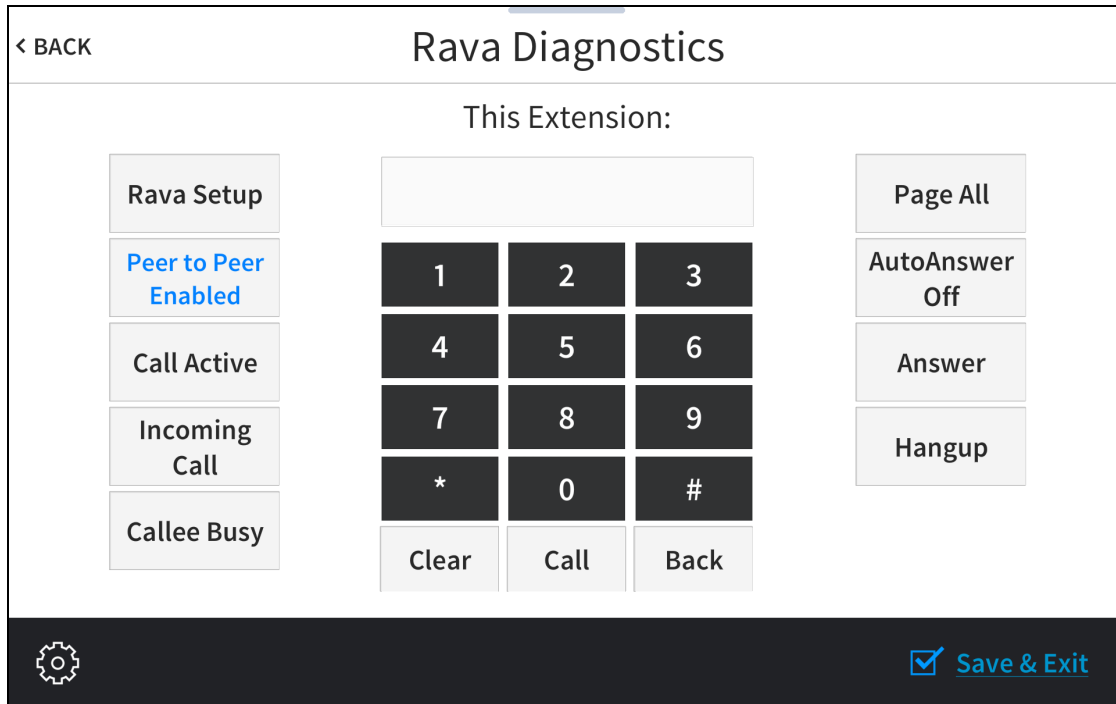

Use the **Rava Diagnostics** screen to test using the Rava® SIP Intercom with the touch screen. Rava SIP intercom technology enables hands-free VoIP communication with other Rava-enabled touch screens and door stations. Rava works over Ethernet, supporting 2-way intercom and paging without requiring any special wiring.

This screen may be used to call another touch screen that has a Rava SIP intercom, to test and configure projects, and to adjust various Rava settings.

- To place a call to another touch screen with a Rava SIP intercom, enter the extension of the touch screen using the numeric keypad, and then tap **Call**.

NOTE: If the intercom functions but the Rava project does not, there is an issue with the project. If the intercom does not function, there is an issue with the intercom settings.

- Use the buttons on the left and right of the screen to view or control various call settings.

Tap **Rava Setup** to display the **Rava Settings** screen.

Rava Settings Screen

< BACK APPLY

Touch a Setting to Edit
Rava connection mode

Peer to Peer Mode SIP Server Mode

Local extension <input type="text"/>	SIP server IP address <input type="text" value="NONE"/>
Member groups <input type="text" value="CRESTRON"/>	Port (default 5060) <input type="text" value="5060"/>
Display name <input type="text" value="CRESTRON"/>	SIP server username <input type="text" value="guest"/>
Port (default 5060) <input type="text" value="5060"/>	SIP server password <input type="password" value="****"/>
Proxy IP address (optional) <input type="text" value="NONE"/>	SIP server realm <input type="text" value="*"/>

Save & Exit

The Rava Settings screen provides controls to switch between **Peer to Peer Mode** and **SIP Server Mode**. Tapping the text fields on the screen opens the on-screen keyboard or on-screen numeric keypad for entering the appropriate information.

NOTE: The touch screen Rava SIP intercom may be configured to connect to a supported door station as part of a Crestron Home® OS door station solution. For more information, refer to the [Crestron Home OS Product Manual](#).

Tap **APPLY** to save any changes. Tap **< BACK** to return to the **Rava Diagnostics** screen.

Tap **< BACK** on the **Rava Diagnostics** screen to return to the **Diagnostics & Advanced** screen.

Mic Test

Tap **Mic Test** on the **Diagnostics & Advanced** screen to begin a microphone test.

Mic Test Screen

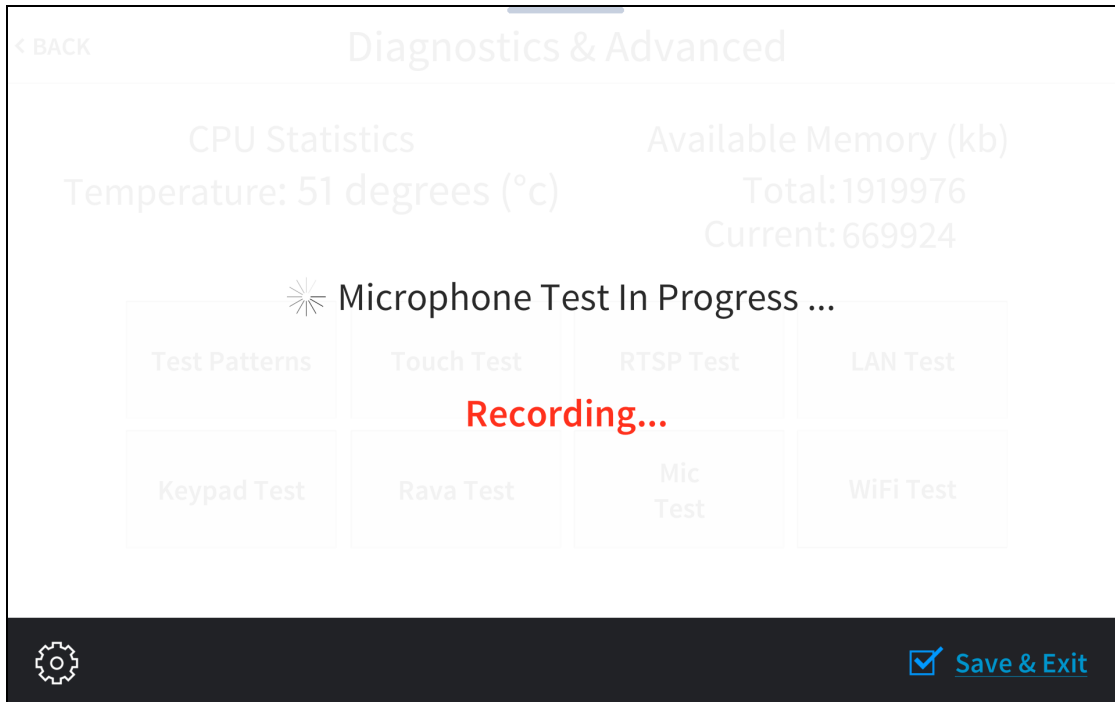

During a microphone test, the built-in microphones record sound for five seconds and then play the sound back to confirm that the microphones are functioning. This test is performed twice: The first test records and plays sound back from the left microphone, and the second test records and plays sound back from the right microphone.

When the second playback is finished, the display automatically returns to the **Diagnostics & Advanced** screen.

Wi-Fi Test

Tap **Wi-Fi Test** on the **Diagnostics & Advanced** screen to display the **Wi-Fi Diagnostics** screen.

Wi-Fi Diagnostics Screen

< BACK

WiFi Diagnostics

Current WiFi Settings Link: ●

WiFi MAC: 00:00:00:00:00:00	IP Address: 10.0.1.6
Subnet Mask: 255.255.255.0	Default Router: 10.0.1.1
Primary DNS: 10.0.1.1	Secondary DNS:
Hostname: 1070-00107FDA645F	Domain: localdomain
SSID: Ham	
BSSID: b8:c7:5d:07:f7:f7	Signal Str: 100 %
Radio Band: G	RSSI: -21 dB

Ping Default Router Test

 Save & Exit

Use the **Wi-Fi Diagnostics** screen to view and test the Wi-Fi network connection. The **Wi-Fi Diagnostics** screen displays the Wi-Fi network MAC and IP addresses, subnet mask address, default router address, primary and secondary DNS addresses, host name, and domain name. A **Link** indicator is provided to indicate the status of the Wi-Fi network connection. (Green indicates that the Wi-Fi network connection is active.)

The **Wi-Fi Diagnostics** screen also provides controls to test the connection to the default router. Tap **On** to begin the test and **Off** to end the test.

During the router test, the touch screen pings the default router. If the router is communicating with the touch screen, connection data is displayed below the ping test controls within five seconds. The connection data updates after every successive ping.

Tap **< BACK** to return to the **Diagnostics & Advanced** screen.

About

Tap **About** on the Setup screen to display the **About** screen.

About Screen

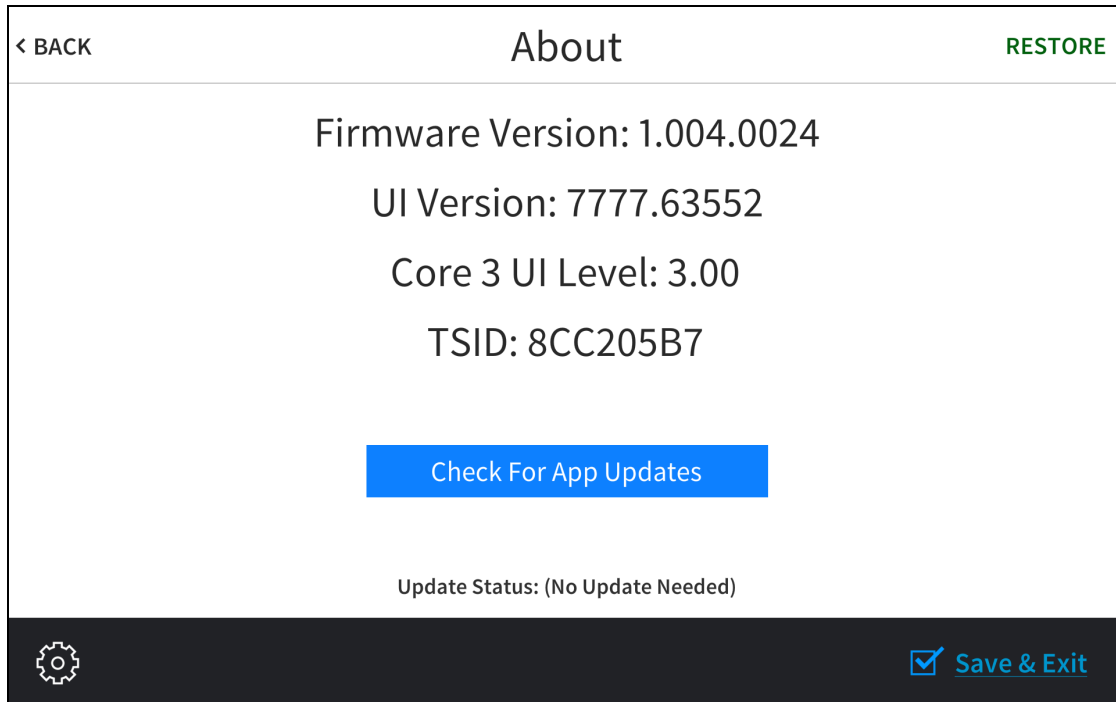

Use the **About** screen to view information about the touch screen, including the firmware version and the operating system versions.

Tap **Check For App Updates** to scan the network for any updates to the touch screen applications. If application updates are available, the touch screen downloads and installs the updates. The status of the updates is shown on the bottom of the screen.

NOTE: The **Check For App Updates** button is shown only if an application is running on the touch screen.

Tap **RESTORE** at the top right of the screen to restore the touch screen to its default factory settings.

Tap **< BACK** to return to the Setup screen.

Web Configuration

The touch screen may be monitored and configured using the included web configuration interface. The configuration interface is accessible from a web browser if the touch screen IP address is known.

The web configuration interface is also accessible through the XiO Cloud® service. For more information, refer to [Connect to XiO Cloud Service on page 164](#).

To access the configuration interface:

1. Use the Device Discovery tool in Crestron Toolbox™ software to discover the touch screen and its IP address on the network.
2. Open a web browser.
3. Enter the touch screen IP address into the browser URL field. The configuration interface is displayed (TS-1070 shown).

NOTE: If authentication is turned on for the touch screen, an administrator username and password must be entered prior to accessing the web configuration interface. For more information on configuring authentication settings, refer to [Web Configuration on page 120](#).

Web Configuration Interface

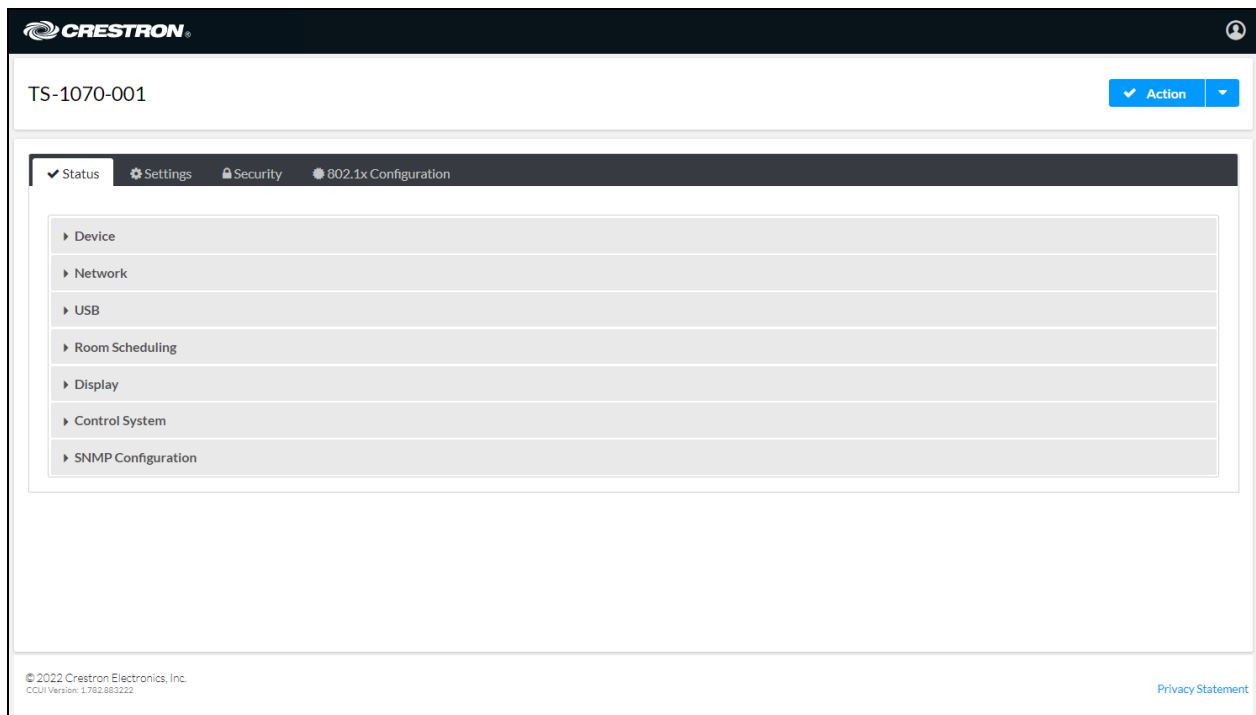

The configuration interface provides the following tabs:

- **Status:** Used to monitor touch screen status
- **Settings:** Used to configure touch screen settings
- **Security:** Used to enable authentication and other security settings
- **802.1x Configuration:** Used to configure IEEE 802.1X network authentication for touch screen security

NOTE: Some device settings may be displayed or hidden depending on the selected application mode.

If the Crestron room scheduling application is running on the touch screen, the web configuration utility provides additional configuration options for the room scheduling application. For more information, refer to the [Crestron Room Scheduling Panels Operations Guide](#).

The **Status** tab is the default tab that is displayed, as shown in the previous image.

Actions Menu

The configuration interface provides an **Actions** drop-down menu on the top right of the page. The **Actions** menu may be accessed at any time.

Actions Menu

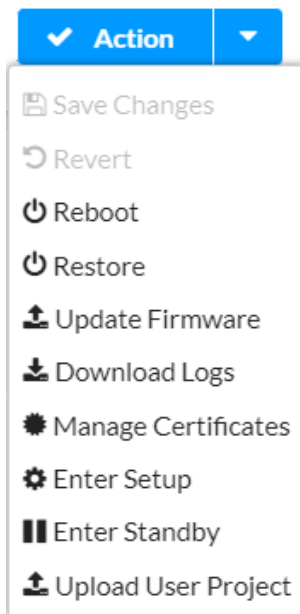

Once any changes have been made to the touch screen configuration, the **Actions** button changes to a **Save Changes** button. Select **Save Changes** to save changes to the configuration settings.

If a restart is required after changes have been saved, a dialog box is displayed asking whether the restart should be performed. Select **Yes** to restart the device or **No** to cancel the restart.

The **Actions** menu provides the following selections.

Save Changes

Select **Save Changes** to save any changes made to the configuration settings.

Revert

Select **Revert** to revert the touch screen back to the last saved configuration settings.

Reboot

Select **Reboot** to restart the touch screen.

After **Reboot** is selected, a dialog box is displayed asking whether the touch screen should be restarted. Select **Yes** to restart the device or **No** to cancel the restart.

Restore

Select **Restore** to restore the touch screen configuration settings to their default values.

After **Restore** is selected a dialog box is displayed asking whether the device settings should be restored. Select **Yes** to restore the settings or **No** to cancel the restore.

Update Firmware

Select **Update Firmware** to upgrade the touch screen firmware manually with a downloaded PUF (package update file). The **Firmware Upgrade** dialog box opens.

Firmware Upgrade Dialog Box

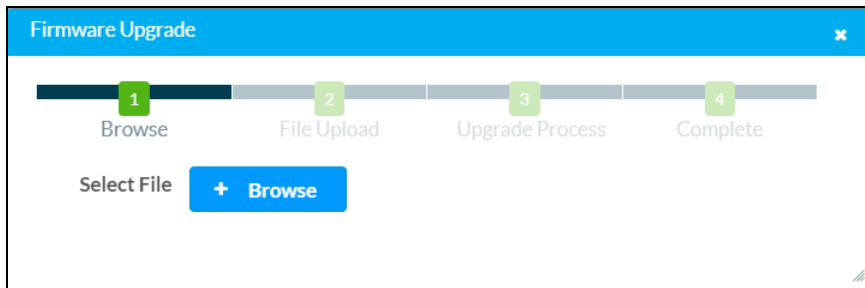

To upload a firmware PUF through the web configuration interface:

NOTE: Visit the appropriate device product page or www.crestron.com/Support/Resource-Library to download the latest firmware PUF.

1. Select **Browse**, and then navigate to the firmware PUF on the host computer.
2. Select the firmware PUF, and then select **Open**.
3. Select **Load** to load the PUF to the touch screen. The upload progress is shown in the dialog box.
4. Once the touch screen has completed the firmware upgrade, select **OK**.

Select the **x** button to close the **Firmware Upgrade** dialog box at any time during the upgrade process. Selecting the **x** button before the PUF is uploaded to the touch screen cancels the upgrade.

Download Logs

Select **Download Logs** to download the touch screen message logs for diagnostic purposes. The message files download as a compressed .tgz file. Once the compressed file is downloaded, extract the message log files to view them.

Manage Certificates

Select **Manage Certificates** to manage any certificates that are installed on the touch screen. For more information on certificate management, refer to [802.1x Configuration on page 158](#).

Enter Setup

Select **Enter Setup** to force the touch screen to enter its built-in setup interface.

Enter Standby

Select **Enter Standby** to force the touch screen to enter standby mode.

Upload User Project

Select **Upload User Project** to upload a custom user project to the touch screen. A **Project Upload** dialog box opens.

Project Upload Dialog Box

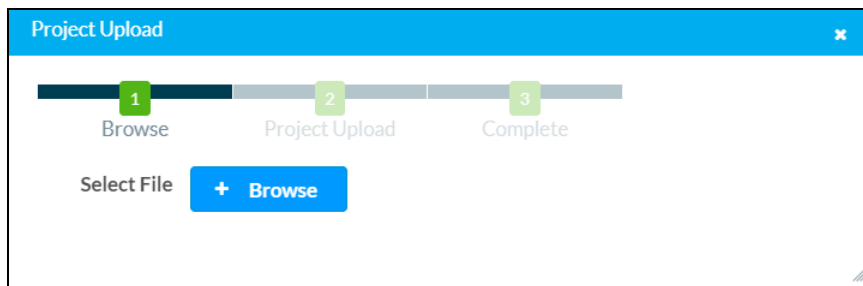

NOTE: This selection is available only if the touch screen is running in user project mode.

To upload a custom user project:

1. Select **Browse**, and then navigate to the project .vtz file on the host computer.
2. Select the project .vtz file, and then select **Open**.
3. Select **Load** to load the project .vtz file to the touch screen. The upload progress is shown in the dialog box.
4. Once the touch screen has completed the project upload, select **OK**.

Select the **x** button to close the **Project Upload** dialog box at any time during the upgrade process. Selecting the **x** button before the project file is uploaded to the touch screen cancels the upload.

Upload Scheduling Project

Select **Upload Scheduling Project** to upload a custom scheduling project to the touch screen. A **Project Upload** dialog box opens.

Project Upload Dialog Box

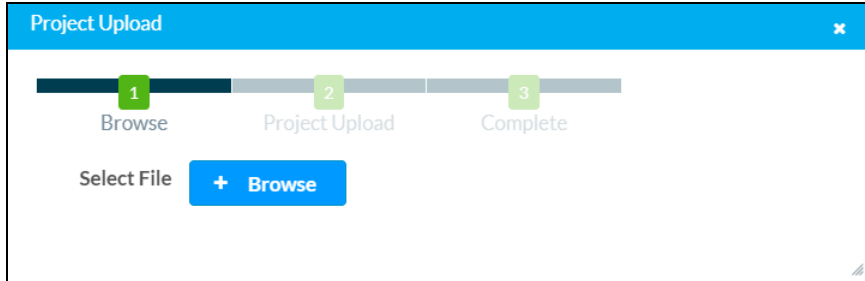

NOTE: This selection is available only if the touch screen is running in **Crestron Default** scheduling mode.

To upload a custom scheduling project:

1. Select **Browse**, and then navigate to the project .vtz file on the host computer.
2. Select the project .vtz file, and then select **Open**.
3. Select **Load** to load the project .vtz file to the touch screen. The upload progress is shown in the dialog box.
4. Once the touch screen has completed the project upload, select **OK**.

Select the **x** button to close the **Project Upload** dialog box at any time during the upgrade process. Selecting the **x** button before the project file is uploaded to the touch screen cancels the upload.

App Upgrade

Select **App Upgrade** to update the currently selected application. The update progress is shown in a pop-up window.

Once the update is complete, select **OK** to close the pop-up window.

Status

Select the **Status** tab on the top left of the configuration interface to display selections for viewing the status of device, network, and control system settings.

Select on a selection name to expand the selection. If the selection is expanded, select the selection name again to collapse the section.

Status Tab Selections

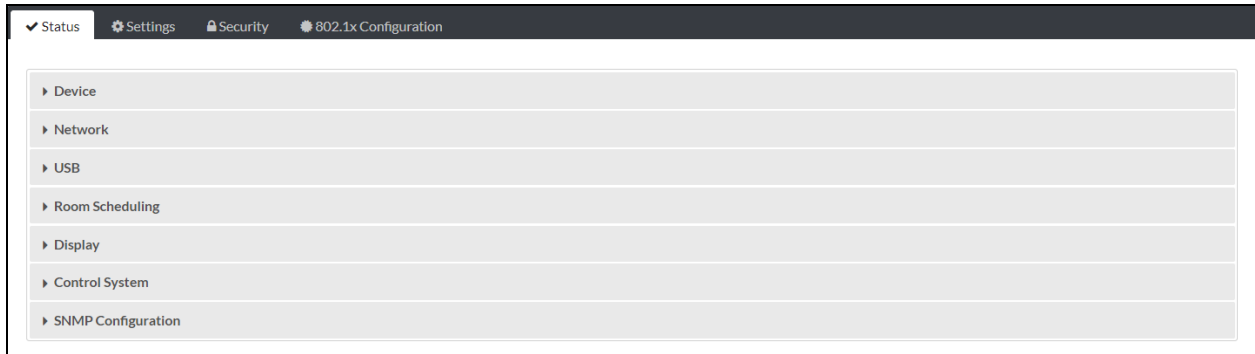

Each selection is described in the sections that follow.

Device

Select **Device** to view general device information.

Status Tab - Device

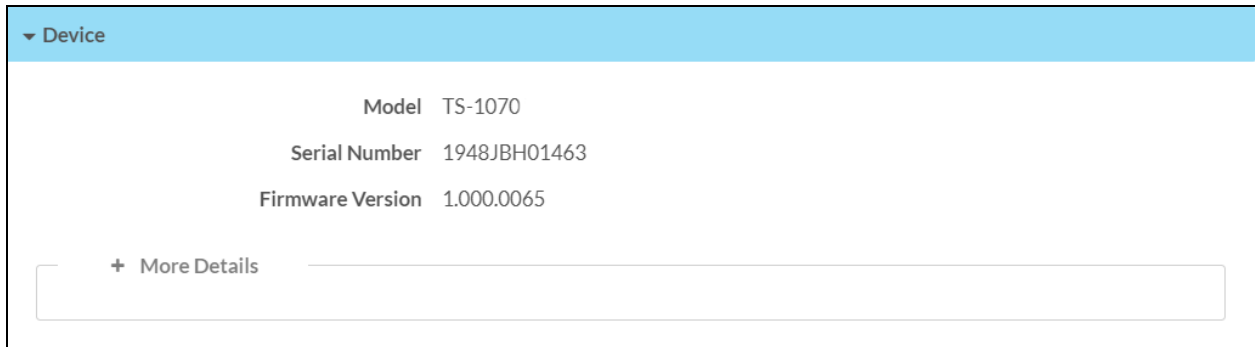

The following **Device** information is displayed:

- **Model:** The touch screen model name
- **Serial Number:** The touch screen serial number
- **Firmware Version:** The firmware version loaded onto the touch screen

Select **+ More details** at the bottom of the **Device** tab to display an expanded section that shows additional touch screen information. If **+ More Details** is selected, select **- Less** details to collapse the section.

Network

Select **Network** to view the status of the network settings for the touch screen.

Status Tab - Network

The screenshot displays the Network status tab with the following settings:

- Host Name:** TS-1070-001
- IPv6 Enabled:** Yes
- DNS Servers (IPv6):** ,
- DNS Servers (IPv4):** 10.0.1.1(DHCP)

Primary LAN

- Domain:** localdomain
- IPv4:**
 - DHCP Enabled:** On
 - IP Address:** 10.0.1.0
 - Subnet Mask:** 255.255.255.0
 - Default Gateway:** 10.0.1.1
 - Link Active:** True
 - MAC Address:** 00.10.7f.da.64.00
- IPv6:**
 - Default Gateway:** ::

Subnet Prefix Length	IP Address	Type
64	fe80::6a8c:d44:f5ad:fe80	Link Local

WIFI

- Domain:** localdomain
- IPv4:**
 - Link Active:** False
 - MAC Address:** de.ad.be.ef.12.de

LAN

- Network Proxy Settings:** Disabled

The following **Network** information is displayed:

- **Host Name:** The touch screen host name
- **IPv6 Enabled:** Reports whether IPv6 addressing is turned on (**Yes**) or not (**No**)
- **DNS Servers (IPv6):** The DNS (domain name server) addresses used to resolve the touch screen domain to an IPv6 address
- **DNS Servers (IPv4):** The DNS (domain name server) addresses used to resolve the touch screen domain to an IPv4 address

Select the + (plus) icon next to **Primary LAN** to display the following Ethernet settings:

- **Domain:** The touch screen domain name
- **IPv4:** Contains settings for IPv4 Ethernet addressing
 - **DHCP Enabled:** Reports whether the IPv4 Ethernet address is static (**Yes**) or dynamic (**No**)
 - **IP Address:** The touch screen IPv4 Ethernet address, shown only if an Ethernet connection is active
 - **Subnet Mask:** The touch screen subnet mask address, shown only if an Ethernet connection is active
 - **Default Gateway:** The gateway router address, shown only if an Ethernet connection is active
 - **Link Active:** Reports the status of the Ethernet connection (A **true** message indicates that the Ethernet connection is active, while a **false** message indicates that the Ethernet connection is inactive.)
 - **MAC Address:** The unique MAC (media access control) address for the Ethernet adapter
- **IPv6:** Contains settings for IPv6 Ethernet addressing
 - **Default Gateway:** The gateway router address, shown only if an Ethernet connection is active and IPv6 addressing is active
 - Each IPv6 Ethernet address configured for the touch screen is displayed in a table with the following information:
 - **Subnet Prefix Length:** The subnet prefix length for the IPv6 Ethernet address
 - **IP Address:** The IPv6 Ethernet address
 - **Type:** The IPv6 Ethernet address type

Select the + (plus) icon next to **WI-FI** to display the following Wi-Fi network settings:

- **Domain:** The Wi-Fi network domain name
- **DHCP Enabled:** Reports whether the Wi-Fi network IP address is static (**Yes**) or dynamic (**No**), shown only if a Wi-Fi network connection is active
- **IP Address:** The Wi-Fi network IP address, shown only if a Wi-Fi network connection is active
- **Subnet Mask:** The Wi-Fi network subnet mask address, shown only if a Wi-Fi network connection is active
- **Default Gateway:** The Wi-Fi network gateway router address, shown only if a Wi-Fi network connection is active
- **Link Active:** Reports the status of the Wi-Fi network connection (A **true** message indicates that the Wi-Fi network connection is active, while a **false** message indicates that the Wi-Fi network connection is inactive.)
- **MAC Address:** The unique Wi-Fi network MAC (media access control) address

Select the + (plus) icon next to **LAN** to display the following LAN settings:

- **Network Proxy Settings:** Reports whether network proxy settings are turned on or off for the touch screen

For more information on configuring network settings, refer to [System Setup on page 132](#).

USB

Select **USB** to view the status of a connected USB accessory, such as a room scheduling hallway sign or light bar.

Status Tab - USB

▼ USB
Accessory Connected No
Accessory Type

The following **USB** information is displayed:

- **Accessory Connected:** The name of the connected accessory
- **Accessory Type:** The type of connected accessory

Room Scheduling

Select **Room Scheduling** to view the status of the room if using a room scheduling application.

Status Tab - Room Scheduling

▼ Room Scheduling
Room Status Offline
Calendar Sync
Fusion Online Status Offline

The following **Room Scheduling** information is displayed:

- **Room Status:** The status of the connected room (available or reserved)
- **Calendar Sync:** The status of the sync between the touch screen and the room scheduling calendar
- **Crestron Fusion Online Status:** The status of the Crestron Fusion connection (if applicable)

Display

Select **Display** to view the display status.

Status Tab - Display

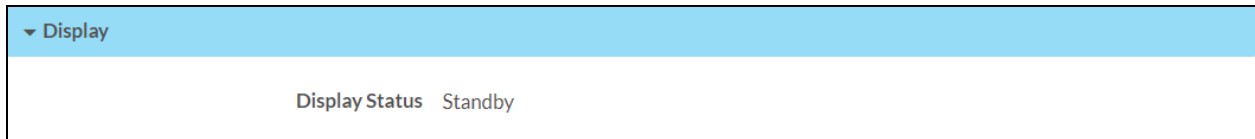

The **Display Status** field indicates the display status (on, standby, or screensaver).

Control System

Select **Control System** to view the status of a connected control system.

NOTE: The **Control System** accordion is shown in user project mode only.

Status Tab - Control System

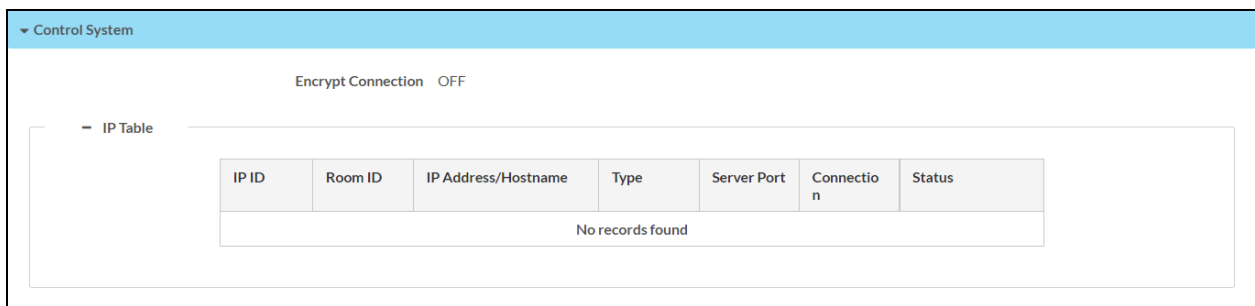

The following **Control System** information is displayed:

- **Encrypt Connection:** Indicates whether the connection between the control system and touch screen is encrypted
- **IP Table:** Displays the IP table information for the control system connection:
 - **IP ID:** The IP ID used to connect the touch screen to the control system
 - **Room ID:** The control system room ID that the touch screen is associated with (for connections to the Crestron Virtual Control server-based control system)
 - **IP Address/Hostname:** The control system IP address or host name
 - **Type:** The control system connection type
 - **Server Port:** The server port used for the connection
 - **Connection:** The control system connection method
 - **Status:** The control system connection status

SNMP Configuration

Select **SNMP Configuration** to view the status of the SNMP (Simple Network Management Protocol) configuration for the touch screen.

Status Tab - SNMP Configuration

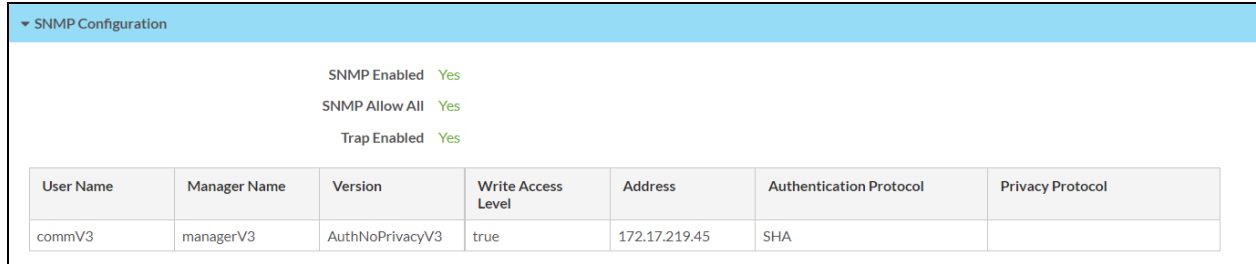

The screenshot shows the 'SNMP Configuration' status tab. It displays three configuration options: 'SNMP Enabled' (Yes), 'SNMP Allow All' (Yes), and 'Trap Enabled' (Yes). Below these options is a table with the following data:

User Name	Manager Name	Version	Write Access Level	Address	Authentication Protocol	Privacy Protocol
commV3	managerV3	AuthNoPrivacyV3	true	172.17.219.45	SHA	

The following **SNMP Configuration** information is displayed:

- **SNMP Enabled:** Reports whether SNMP has been turned on for the touch screen (**Yes**) or not (**No**)
- **SNMP Allow All:** Reports whether the touch screen allows SNMP requests from all managers (**Yes**) or not (**No**)
- **Trap Enabled:** Reports whether SNMP trap notifications have been turned on (**Yes**) or not (**No**)
- Each SNMP user configured for the touch screen is displayed in a table with the following information:
 - **User Name:** The name of the SNMP user
 - **Manager Name:** The SNMP manager for the user
 - **Version:** The SNMP version set for the user
 - **Write Access Level:** Indicates whether the user has write level permissions (**true**) or read-only permissions (**false**)
 - **Address:** The IP address of the SNMP manager
 - **Authentication Protocol:** The authentication protocol used by the SNMP manager
 - **Privacy Protocol:** The privacy protocol used by the SNMP manager

Settings

Select the **Settings** tab on the top left of the configuration interface to display selections for configuring various touch screen settings and to select a touch screen application.

Settings Selections

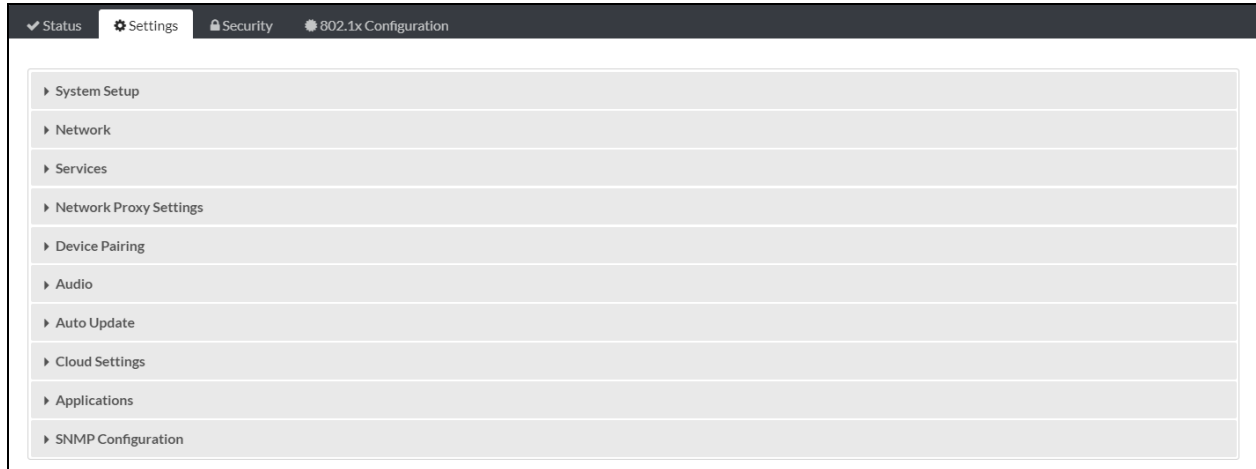

Each selection is described in the sections that follow.

NOTE: If an invalid value is entered for a setting, the web interface will not allow changes to be saved until a valid value is entered. Red text is displayed next a setting to indicate an invalid value.

System Setup

Select **System Settings** to configure general network and touch screen settings.

Settings Tab - System Setup

▼ System Setup

- + Date/Time
- + Control System
- + Device Display
- + Proximity
- + Button Toolbar
- + Pinpoint Beacon

Date/Time

Select the + (plus) icon next to **Date/Time** to display the following time and date settings.

Settings Tab - System Setup (Date/Time)

- Date/Time

Synchronization

Time Synchronization

Synchronize Now

NTP Time Servers

<input type="checkbox"/>	Address	Port	Authentication Method	Authentication Key	Key ID
<input type="checkbox"/>	pool.ntp.org	123	None	0

Add Remove

Configuration

Time Zone (UTC - 05: 00) Eastern Time (US & ...)

Date 04/30/2021

Time Format 12 24

Date Format WMDY

Time 15:30

Time Synchronization

- **Time Synchronization:** Turn on the toggle to use time synchronization via SNTP (Simple Network Time Protocol).
- **Synchronize Now:** With **Time Synchronization** turned on, select **Synchronize Now** to synchronize the touch screen with the SNTP server(s) entered in the **NTP Time Servers** table.

- **NTP Time Servers:** With **Time Synchronization** turned on, use the provided table to enter information regarding the SNTP server(s) used to synchronize the date and time for the touch screen.
 - Select **Add** to add a new SNTP server entry into the table.
 - Enter the following information for each entry:
 - Enter the SNTP server address into the **Address** text field.
 - Enter the SNTP server port into the **Port** text field.
 - Use the **Authentication Method** drop-down menu to select the authentication method used to access the SNTP server (if one exists).
 - If an authentication method is selected, enter the key used to authenticate against the SNTP server into the **Authentication Key** text field.
 - If an authentication method is selected, enter the ID for the key used to authenticate against the SNTP server into the **Key ID** text field.
 - To remove an entry, fill the checkbox to the left of the table entry, and then select **Delete**.

Time Configuration

- **Time Zone:** Select a time zone for the touch screen using the drop-down menu.
- **Date:** Select the date for the touch screen using the pop-up calendar that is displayed.
- **Time Format:** Select the format that the time will display on the touch screen (12 hour or 24 hour).
- **Date Format:** Select the format that the date will display on the touch screen using the drop-down menu.
- **Time:** Select the time for the touch screen (in 24-hour format) using the pop-up menu that is displayed.

Control System

Select the + (plus) icon next to **Control System** to display the following control system connection settings.

NOTE: The **Control System** settings are shown in user project mode only.

Settings Tab - System Setup (Control System)

The screenshot displays the 'Control System' settings interface. At the top, there is a blue button labeled 'Encrypt Connection'. Below it, the text 'IP Table' is visible. The table has three columns: 'IP ID', 'IP Address/Hostname', and 'Room ID'. The first row contains the value '12' in the 'IP ID' column and '10.0.1.0' in the 'IP Address/Hostname' column. The 'Room ID' column is currently empty. Below the table, there are two buttons: a blue '+ Add' button and a grey '✖ Remove' button.

<input type="checkbox"/>	IP ID	IP Address/Hostname	Room ID
<input type="checkbox"/>	12	10.0.1.0	Room ID

Select **Encrypt Connection** to create an encrypted connection to the control system. If the control system has authentication enabled, its username and password must be entered in the **Security** tab. For more information, refer to [Security on page 150](#).

- **IP Table:** Set an IP table connection between the touch screen and control system:
 - **IP ID:** Enter an IP ID for connecting the touch screen to the control system.
 - **IP Address/Hostname:** Enter the control system IP address or host name.
 - **Room ID:** Enter a room ID to associate with the touch screen (for connections with the Crestron Virtual Control server-based control system)

NOTE: For more information on connecting the touch screen to Crestron Virtual Control, refer to the help file in the Crestron Virtual Control web configuration interface. To access the help file, select the question mark button  on the top left of the page.

Device Display

Select the + (plus) icon next to **Device Display** to display the following device display settings.

Settings Tab - System Setup (Device Display)

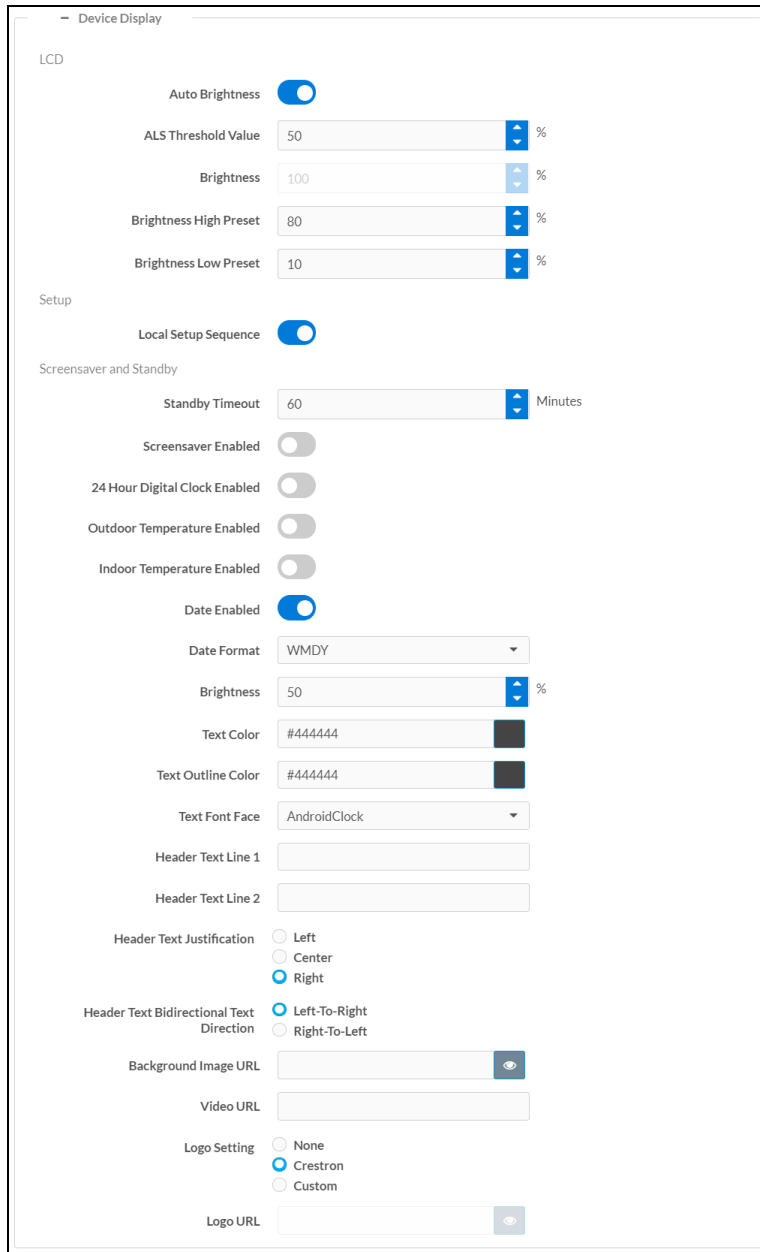

Device Display

LCD

Auto Brightness

ALS Threshold Value 50 %

Brightness 100 %

Brightness High Preset 80 %

Brightness Low Preset 10 %

Setup

Local Setup Sequence

Screensaver and Standby

Standby Timeout 60 Minutes

Screensaver Enabled

24 Hour Digital Clock Enabled

Outdoor Temperature Enabled

Indoor Temperature Enabled

Date Enabled

Date Format WMDY

Brightness 50 %

Text Color #444444

Text Outline Color #444444

Text Font Face AndroidClock

Header Text Line 1

Header Text Line 2

Header Text Justification Left Center Right

Header Text Bidirectional Text Direction Left-To-Right Right-To-Left

Background Image URL

Video URL

Logo Setting None Crestron Custom

Logo URL

- LCD

- **Auto Brightness:** Turn on the toggle to use automatic brightness control for the touch screen LCD display.
- **ALS Threshold Value:** If **Auto Brightness** is turned on, enter a value (1–100%) for the ALS (ambient light sensor) threshold, which is used for switching between high and low autobrightness presets.

- **Brightness:** If **Auto Brightness** is turned off, enter a value (1–100%) for the LCD display brightness.
- **Brightness High Preset:** Enter a value (1–100%) for the LCD display high brightness preset.
- **Brightness Low Preset:** Enter a value (1–100%) for the LCD display low brightness preset.
- **Setup**
 - **Local Setup Sequence:** Turn on the toggle to allow local access to the setup screens using a five-finger press.
- **Screensaver and Standby**
 - **Standby Timeout:** Enter a standby timeout duration (1–120 minutes) for the touch screen.
 - **Screensaver Enabled:** Turn on the toggle to show a screensaver on the touch screen during standby timeout.
 - **24 Hour Digital Clock Enabled:** Turn on the toggle to display a 24-hour digital clock on the touch screen during standby timeout.
 - **Outdoor Temperature Enabled:** Turn on the toggle to display the outdoor temperature on the touch screen during standby timeout via a join from a control system.
 - **Indoor Temperature Enabled:** Turn on the toggle to display the indoor temperature on the touch screen during standby timeout via a join from a control system.
 - **Date Enabled:** Turn on the toggle to display the date on the touch screen during standby timeout.
 - **Date Format:** Use the drop-down menu to select a format for displaying the date on the touch screen.
 - **Brightness:** Enter a brightness value (1–100%) for the screensaver.
 - **Text Color:** Select the color icon to the right of this field to display a pop-up window for selecting the text color of the screensaver, or enter a hex value for a specific color.
 - **Text Outline Color:** Select the color icon to the right of this field to display a pop-up window for selecting the text outline color of the screensaver, or enter a hex value for a specific color.
 - **Text Font Face:** Use the drop-down menu to select a font for the screensaver text.
 - **Header Text Line 1:** Enter text to be displayed on the first header text line of touch screen screensaver.
 - **Header Text Line 2:** Enter text to be displayed on the second header text line of touch screen screensaver.
 - **Header Text Justification:** Select one of the radio buttons (**Left**, **Center**, or **Right**) to select how the header text is justified on the touch screen screensaver.

- **Header Text Bidirectional Text Direction:** Select one of the radio buttons (**Left-To-Right** or **Right-To-Left**) to determine the language text direction on the touch screen screensaver.
- **Background Image URL:** Enter a URL of a background image to be used by the touch screen screensaver.
- **Video URL:** Enter a URL of video to be used by the touch screen screensaver.
- **Logo Setting:** Select one of the radio buttons (**None**, **Crestron**, and **Custom**) to select a logo type to use on the touch screen screensaver.
- **Logo URL:** If **Logo Setting** is set to **Custom**, enter a URL of a custom logo to be used by the touch screen screensaver.

Proximity

Select the + (plus) icon next to **Proximity** to display the following proximity settings.

Settings Tab - System Setup (Proximity)



Turn on the **Wake On Proximity** toggle wake the touch screen automatically when a user enters the touch screen proximity field.

Button Toolbar

Select the + (plus) icon next to **Button Toolbar** to display the following virtual toolbar button settings.

Settings Tab - System Setup (Button Toolbar)

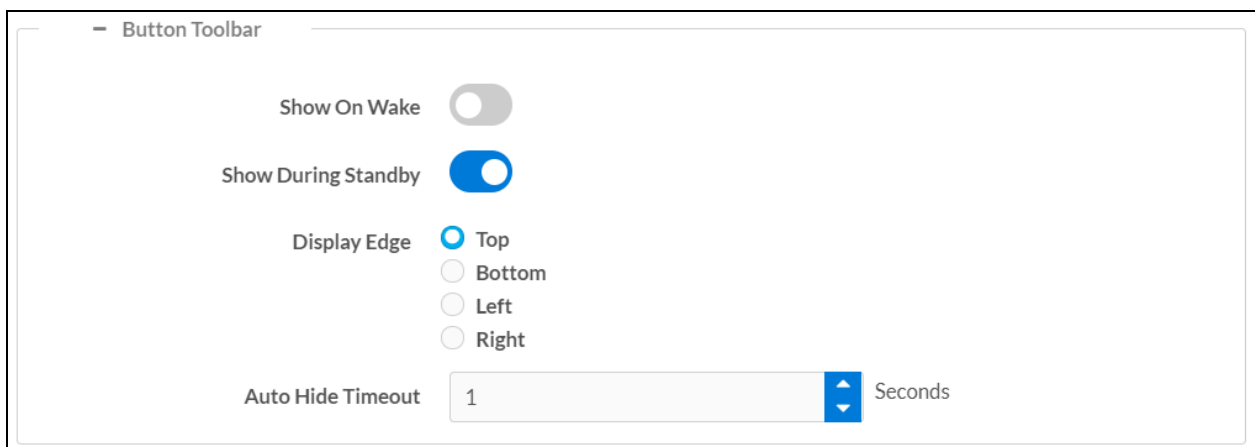

- **Show On Wake:** Turn on the toggle to show the virtual toolbar when the touch screen wakes from standby timeout.
- **Show During Standby:** Turn on the toggle to show the virtual toolbar during standby timeout.

- **Display Edge:** Select a radio button (**Top**, **Bottom**, **Left**, or **Right**) to select the position on the touch screen where the virtual toolbar is displayed.
- **Auto Hide Timeout:** Select a duration (in seconds) that must elapse before the virtual toolbar is hidden automatically.

Pinpoint Beacon

Select the + (plus) icon next to **PinPoint Beacon** to display the following Bluetooth beacon settings.

Settings Tab - System Setup (PinPoint Beacon)



- **BT Enabled:** Turn on the toggle to use the Bluetooth beacon.
- **BT Mode:** Use the drop-down menu to select the mode (**Advertise** or **Config**) of the Bluetooth beacon.
 - Select **Advertise** to make the Bluetooth beacon available to Crestron devices that support this functionality.
 - Select **Config** to put the Bluetooth beacon into configuration mode.

Network

Select **Network** to configure network settings for the touch screen.

Settings Tab - System Setup (Network)

The screenshot displays the Network configuration page. At the top, the Hostname is set to 'TSW-1070-001'. The IPv6 Enabled toggle is turned on. Below this, there are fields for Primary and Secondary Static DNS for both IPv6 and IPv4. The Primary LAN section shows the Adapter Enabled toggle is on, with a Domain of 'localdomain'. Underneath, the DHCP toggle is on, and the IP Address, Subnet Mask, and Default Gateway are set to 10.0.1.0, 255.255.255.0, and 10.0.1.1 respectively. An IPv6 section shows a Default Gateway field. A section for 'IPv6 Address with Prefix' contains a search box and 'Add'/'Remove' buttons. The WIFI section shows the Adapter Enabled toggle is on, with a Domain of 'localdomain'. The DHCP Enabled toggle is on, and the IP Address, Subnet Mask, and Default Gateway are all set to 0.0.0.0. A 'Scan WIFI Access Points' button is present, followed by a search box for 'Select Discovered Access Points'. Below this is an 'Add Access Points' button and a table with a warning: 'The maximum configurable access points are limited to 4'. The table has columns for SSID, Encryption Key, Password, and Active Access Point. One entry is visible with SSID 'Hammons1', Encryption Key 'WPA2', and a masked password.

NOTE: The **IP Address**, **Subnet Mask**, and **Default Gateway** fields are required only if DHCP is turned off for Ethernet and Wi-Fi network connections.

- **Hostname:** Enter the touch screen host name.
- **IPv6 Enabled:** Turn on the toggle to use IPv6 addressing for the touch screen.

- **Primary Static DNS (IPv6):** If **IPv6 Enabled** is turned on, enter the primary DNS address used to resolve the touch screen domain to an IPv6 address.
- **Secondary Static DNS (IPv6):** If **IPv6 Enabled** is turned on, enter the secondary DNS address used to resolve the touch screen domain to an IPv6 address.
- **Primary Static DNS (IPv4):** Enter the primary DNS address used to resolve the touch screen domain to an IPv4 address.
- **Secondary Static DNS (IPv4):** Enter the secondary DNS address used to resolve the touch screen domain to an IPv4 address.

Select the + (plus) icon next to **Primary LAN** to display the following Ethernet settings:

- **Adapter Enabled:** Turn on the toggle to use the touch screen Ethernet adapter, which allows the touch screen to make an Ethernet connection.
- **Domain:** Enter the fully qualified domain name on the network.
- **IPv4:** Use these settings to configure IPv4 Ethernet addressing on the network.
 - **DHCP:** Turn on the toggle to use DHCP for the IPv4 Ethernet connection.

NOTE: If DHCP is turned on, IP does not function until a reply has been received from the server. The touch screen broadcasts requests for an IP address periodically.

- **IP Address:** Enter the touch screen IPv4 Ethernet address on the network.
- **Subnet Mask:** Enter the touch screen subnet mask address on the network.
- **Default Gateway:** Enter the gateway router address on the network.
- **IPv6:** Use these settings to configure IPv6 Ethernet addressing on the network.
 - **Default Gateway:** Enter the gateway router address on the network.
 - **IPv6 Address with Prefix:** With **IPv6 Enabled** turned on, use the provided table to add IPv6 Ethernet addresses to the touch screen.
 - Select **Add** to add a new IPv6 Ethernet address to the touch screen.
 - Enter the following information for each entry:
 - Enter the IPv6 Ethernet address into the **Enter IPv6 Address** text field.
 - Enter the prefix for the IPv6 Ethernet address into the text field following the address.
 - If desired, use the copy button  to copy the IPv6 Ethernet address to the clipboard.
 - To remove an entry, fill the checkbox to the left of the table entry, and then select **Remove**.

NOTE: An "x" icon is shown to the right of the IPv6 Ethernet address prefix in a table row if the IPv6 address format is invalid or is missing a prefix. Hover over the icon to view a message explaining the issue.

Select the + (plus) icon next to **Wi-Fi** to display the following Wi-Fi network settings:

- **Adapter Enabled:** Turn on the toggle to use the touch screen Wi-Fi adapter, which allows the touch screen to make a Wi-Fi network connection.
- **Domain:** Enter the fully qualified domain name on the network.
- **IPv4:** Use these settings to configure IPv4 Wi-Fi network addressing on the network.
 - **DHCP:** Turn on the toggle to use DHCP for the IPv4 Wi-Fi network connection.

NOTE: If DHCP is turned on, IP does not function until a reply has been received from the server. The touch screen broadcasts requests for an IP address periodically.

- **IP Address:** Enter the touch screen IPv4 Wi-Fi network address on the network.
- **Subnet Mask:** Enter the touch screen subnet mask address on the network.
- **Default Gateway:** Enter the gateway router address on the network.
- **Wi-Fi Access Points**
 - **Scan Wi-Fi Access Points:** Scans the network for any open Wi-Fi access points. All discovered access points are displayed in the **Select Discovered Access Points** menu.
 - **Select Discovered Access Points:** Select an access point after completing a scan. Enter text in the search field to search for a specific Wi-Fi access point name.
 - **Add Access Points:** Adds the chosen access point entry from the **Select Discovered Access Points** field to the table below.

Each added Wi-Fi access point is displayed in a table that contains the following information.

- **SSID:** Enter or modify the SSID (name) of the Wi-Fi access point.
- **Encryption Key:** Select the security/encryption type used by the Wi-Fi access point.
- **Password:** Enter the password used to connect to the Wi-Fi access point.
- **Active Access Point:** Indicates whether a connection to the Wi-Fi access point is active

Select **Add** to add a new entry to the Wi-Fi access point table. After selecting one more entries in the Wi-Fi access point table, select **Remove** to delete the selected entries.

Services

Select **Services** to configure Crestron Fusion® software settings.

Settings Tab - Services

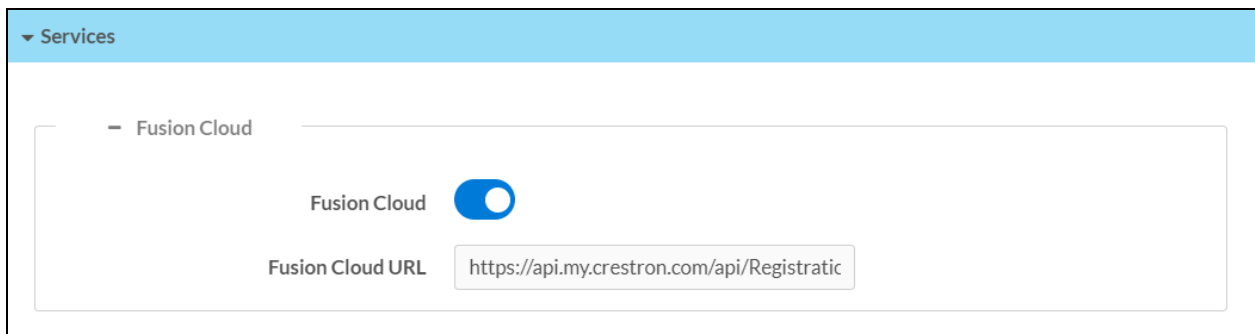

NOTE: If connecting to a Crestron Fusion software on-premises server, connections are made using either traditional (outbound) or inbound communications. For more information, refer to the [Crestron Fusion 10 On-Premises Software Getting Started Guide](#).

- **Crestron Fusion Cloud:** Turn on the toggle to allow a connection to a Crestron Fusion Cloud server. This connection is only applicable when the scheduling mode is set to **Crestron Default** or **User Project**.
- **Crestron Fusion Cloud URL:** Enter the URL used to connect the touch screen to the desired Crestron Fusion Cloud server.

Network Proxy Settings

Select **Network Proxy Settings** to configure network proxy settings for the touch screen.

Settings Tab – Network Proxy Settings

▼ Network Proxy Settings

Proxy

— HTTP Settings

HTTP Proxy

HTTP Proxy Address

HTTP Proxy Port

Username

Password

— HTTPS Settings

HTTPS Proxy

HTTPS Proxy Address

HTTPS Proxy Port

Username

Password

- **Proxy:** Turn on the toggle to configure the touch screen for use with a proxy server.
- **HTTP Settings**

- **HTTP Proxy:** Turn on the toggle to use an HTTP proxy server.
- **HTTP Proxy Address:** Enter the IP address of the HTTP proxy server.
- **HTTP Proxy Port:** Enter the port number of the HTTP proxy server.
- **Username:** Enter the username required for the HTTP proxy server.
- **Password:** Enter the password required for the HTTP proxy server.
- **HTTPS Settings**
 - **HTTPS Proxy:** Turn on the toggle to use an HTTPS proxy server.
 - **HTTPS Proxy Address:** Enter the IP address of the HTTPS proxy server.
 - **HTTPS Proxy Port:** Enter the port number of the HTTPS proxy server.
 - **Username:** Enter the username required for the HTTPS proxy server.
 - **Password:** Enter the password required for the HTTPS proxy server.

Device Pairing

Select **Device Pairing** to configure settings for pairing the touch screen to a CEN-ODT-C-POE. The CEN-ODT-C-POE provides local occupancy reporting for supported room scheduling apps.

NOTE: For more information on the occupancy sensor, refer to the [CEN-ODT-C-POE Supplemental Guide](#). For more information on configuring the occupancy source in the Crestron scheduling application, refer to the [Crestron Room Scheduling Panels Operations Guide](#).

Settings Tab – Device Pairing

▼ Device Pairing

Device Model

Pairing Retry Time (Mins)

Pairing Status Offline

Device IP Address/FQDN Device IP Address/FQDN is invalid

– Device Authentication

Device Username

Device Password

- **Device Model:** Use the drop-down menu to select **POE Occ Sensor**.
- **Pairing Retry Time (Min):** Enter a duration (in minutes) that must elapse before the CEN-ODT-C-POE reattempts to pair to the touch screen.
- **Pairing Status:** Reports whether the CEN-ODT-C-POE is paired to the touch screen (**Online**) or not (**Offline**).

Device IP Address/FQDN: Enter the IP address or fully qualified domain name of the CEN-ODT-C-POE. This is required for device pairing.

Device Authentication: Enter authentication credentials for the CEN-ODT-C-POE (if required):

- **Device Username:** Enter a valid username used to access the device.
- **Device Password:** Enter a valid password used to access the device.

Audio

Select **Audio** to configure various audio settings for the touch screen.

Settings Tab – Audio

The screenshot shows the 'Audio' settings tab. Under the 'Device Audio' section, there are six settings:

- Panel Mute:** A toggle switch that is currently turned off.
- Panel Volume:** A slider set to 75%.
- Media Mute:** A toggle switch that is currently turned off.
- Media Volume:** A slider set to 100%.
- Beep Enabled:** A toggle switch that is currently turned on.
- Beep Volume:** A slider set to 75%.

NOTE: The **Media Volume** setting adjusts the H.264 streaming media level in relation to the **Panel Volume** setting.

- **Panel Mute:** Turn on the toggle to mute the main touch screen volume.
- **Panel Volume:** Enter a value (1–100) for the main touch screen volume level.
- **Media Mute:** Turn on the toggle to mute the touch screen media volume.
- **Media Volume:** Enter a value (1–100) for the touch screen media volume level.
- **Beep Enabled:** Turn on the toggle to mute the touch screen beep volume.
- **Beep Volume:** Enter a value (1–100) for the touch screen beep volume.

Auto Update

Select **Auto Update** to configure automatic firmware updates for the touch screen.

NOTE: The **Auto Update** accordion can be used to configure auto update settings for firmware only. Automatic application updates are not affected by these settings.

Settings Tab - Auto Update

Auto Update

Custom URL

Custom URL Path

- Schedule

Day of Week

Time of Day

Poll Interval Minutes

[Update Now](#)

- **Auto Update:** Turn on the toggle to use automatic firmware updates.
- **Custom URL:** Turn on the toggle use a custom update server URL. If turned off, the server URL will default to the standard Crestron update sever.
- **Custom URL Path:** If **Custom URL Path** is turned on, enter the custom URL path for the update server.
- **Day of Week:** Select the day of week when the touch screen will check for updates. Select Daily to have the touch screen check for updates every day.
- **Time of Day:** Enter a time of day (in 24-hour format) when the touch screen will check updates on the scheduled day.
- **Poll Interval:** Enter the polling interval (in hours) for when the touch screen will poll the server for updates.
- Select **Update Now** to check the update server for new firmware and to update the touch screen immediately if new firmware is available.

Cloud Settings

Select **Cloud Settings** to enable or disable a connection between the touch screen and an XiO Cloud® service account. A connection to the XiO Cloud service is enabled by default.

Settings Tab – Cloud Settings

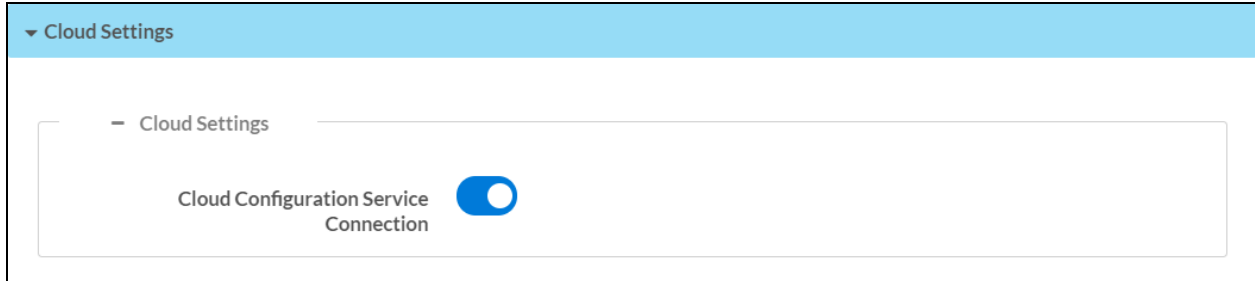

Turn on the **Cloud Configuration Service Connection** to allow a connection between the touch screen and an XiO Cloud account. This setting is turned on by default.

For more information on connecting to the XiO Cloud service, refer to [Connect to XiO Cloud Service on page 164](#).

Applications

Select **Applications** to select an application to run on the touch screen.

Settings Tab – Applications

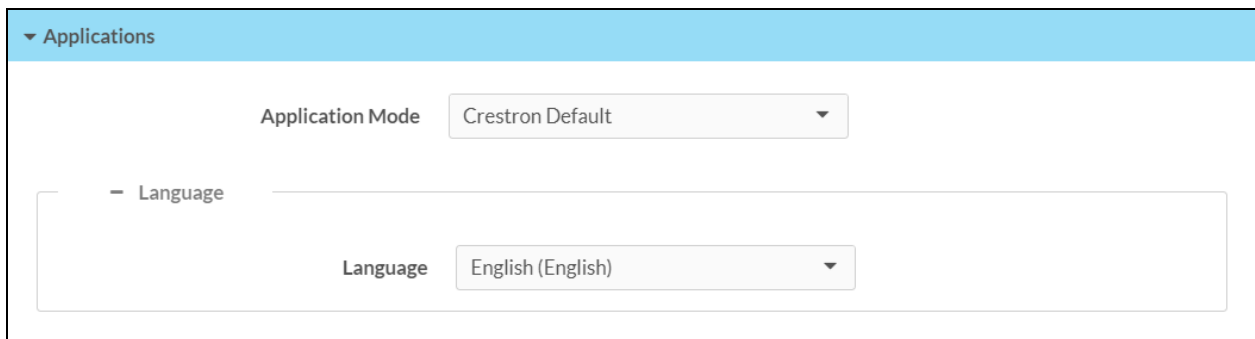

Use the **Application Mode** drop-down menu to select a touch screen application from the available selections. **User Project** is selected by default.

Once a new application is selected, select **Save Changes** from the **Actions** menu. A pop-up dialog box is displayed stating that the touch screen must be rebooted for the new application to take effect. Select **Yes** to restart the touch screen now or **No** to restart the touch screen later. The touch screen restarts with the new application running.



NOTE: Each application uses a unique setup procedure for registering and configuring the application. For more information on supported applications, refer to [Application Selection on page 162](#).

SNMP Configuration

Select **SNMP Configuration** to configure SNMP (Simple Network Management Protocol) settings on the touch screen.

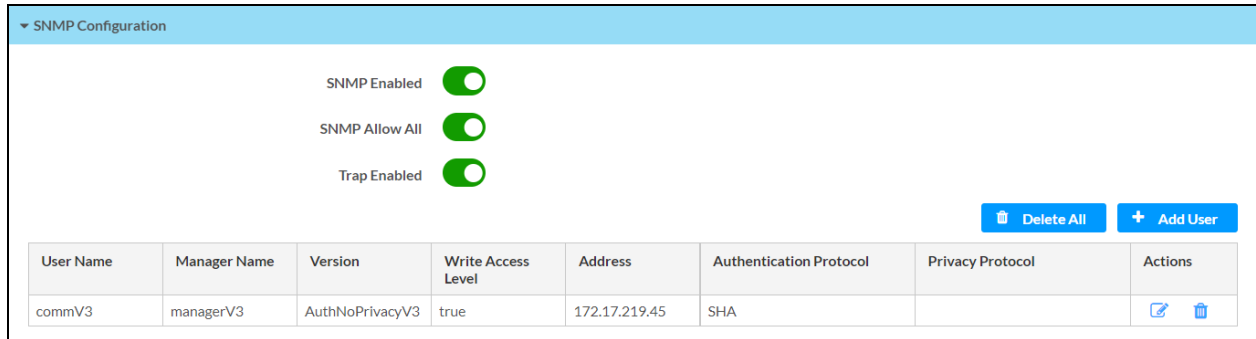
Settings Tab - SNMP Configuration



User Name	Manager Name	Version	Write Access Level	Address	Authentication Protocol	Privacy Protocol	Actions
commV3	managerV3	AuthNoPrivacyV3	true	172.17.219.45	SHA		 

- **SNMP Enabled:** Turn on the toggle to turn on SNMP for the touch screen.
- **SNMP Allow All:** Turn on the toggle to all the touch screen to receive SNMP requests from all managers.
- **Trap Enabled:** Turn on the toggle to turn on SNMP trap notifications.

Each added SNMP user is displayed in a table that contains the following information.

- **User Name:** The name of the SNMP user
- **Manager Name:** The SNMP manager for the user
- **Version:** The SNMP version set for the user
- **Write Access Level:** Indicates whether the user has write level permissions (**true**) or read-only permissions (**false**)
- **Address:** The IP address of the SNMP manager
- **Authentication Protocol:** The authentication protocol used by the SNMP manager
- **Privacy Protocol:** The privacy protocol used by the SNMP manager
- **Actions:** Controls for editing and deleting the SNMP user

Select **Delete All** to delete all existing SNMP users. When a dialog box is shown asking whether all SNMP users should be deleted, select **Yes**.

Select **Add User** to add a new SNMP user. The **Add SNMP Configuration** dialog box is displayed.

Add SNMP Configuration Dialog Box

The dialog box is titled "Add SNMP Configuration" and contains the following fields:

- Manager Name *
- IP Address/Host Name *
- Community Name *
- Write Access Level: Please Select Access Level
- SNMP Version: Please Select SNMP Version
- SNMP Authorization Protocol: None
- SNMP Privacy Protocol: None
- SNMP Security Password: Password
- SNMP Privacy Password: Password

Buttons: OK, CANCEL

Enter the following information for the SNMP user:

- **Manager Name:** Enter the SNMP manager name for the user.
- **IP Address/Host Name:** Enter the IP address or host name of the SNMP manager.
- **Community Name:** Enter the SNMP community (user) name.
- **Write Access Level:** Use the drop-down menu to select whether the user has write level access (**True**) or read-only access (**False**).
- **SNMP Version:** Use the drop-down menu to select the SNMP version used by the manager.
- **SNMP Authorization Protocol:** If required, use the drop-down menu to select the authorization protocol used by the SNMP manager.
- **SNMP Privacy Protocol:** If required, use the drop-down menu to select the privacy protocol used by the SNMP manager.
- **SNMP Security Password:** If required, enter the security password for the SNMP manager.
- **SNMP Privacy Password:** If required, use the privacy password for the SNMP manager.

Select **OK** to create the new user. The user is added to the table within the **SNMP Configuration** accordion.

Security

Select the **Security** tab on the top left of the configuration interface to display selections for configuring security and authentication settings for the touch screen.

Security Tab Selections

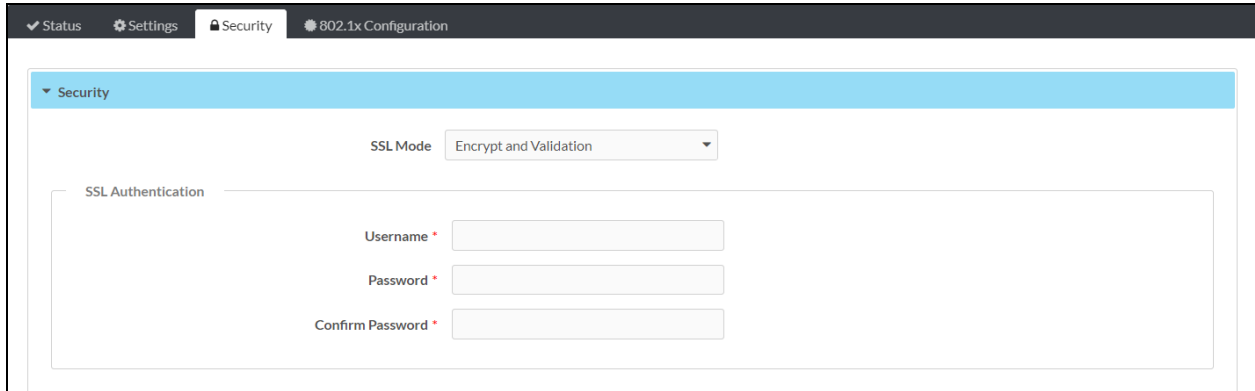

The screenshot shows the configuration interface with the following elements:

- Navigation tabs: Status, Settings, Security, 802.1x Configuration
- Section header: Security
- SSL Mode: A dropdown menu set to "Encrypt and Validation".
- SSL Authentication section containing three input fields:
 - Username *
 - Password *
 - Confirm Password *

Expand the **Security** accordion to configure the following settings:

- **SSL Mode:** Select an SSL (Secure Sockets Layer) mode to use for establishing a secure connection to the touch screen:
 - **Encrypt and Validation:** The touch screen will require a username and password to validate an encrypted SSL connection. Enter a username and password in the appropriate fields that are displayed.
 - **Encrypt:** The touch screen will use an encrypted SSL connection
 - **OFF:** The touch screen will not use an SSL connection.

User and group settings are also displayed within the **Security** accordion.

Authentication Settings

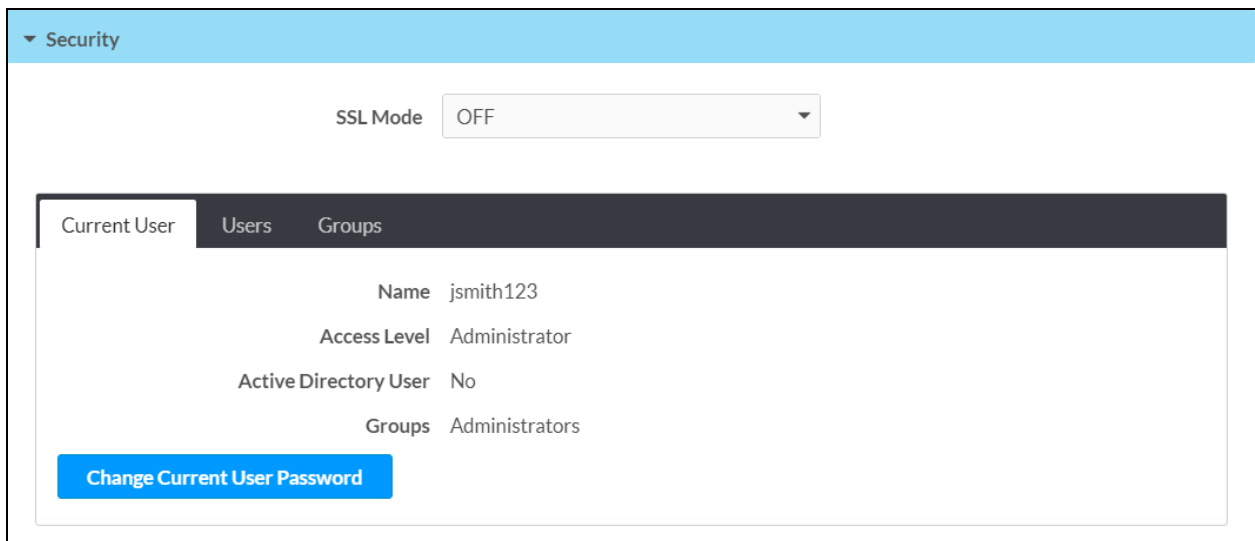

The screenshot shows the configuration interface with the following elements:

- Section header: Security
- SSL Mode: A dropdown menu set to "OFF".
- Current User settings table:

Current User	Users	Groups
Name	jsmith123	
Access Level	Administrator	
Active Directory User	No	
Groups	Administrators	
- Change Current User Password button

The web configuration interface prompts the user to enter a new administrator username and password. After restarting the touch screen, this username and password must be entered to access the web configuration utility or to connect to the touch screen through Crestron Toolbox™ software.

CAUTION: Do not lose the administrator username and password, as the touch screen settings must be restored to factory defaults to reset the username and password.

Use the following settings to add, delete, and edit touch screen users and groups.

Current User

Select the **Current User** tab to view and edit information for the current touch screen user.

Current User Tab

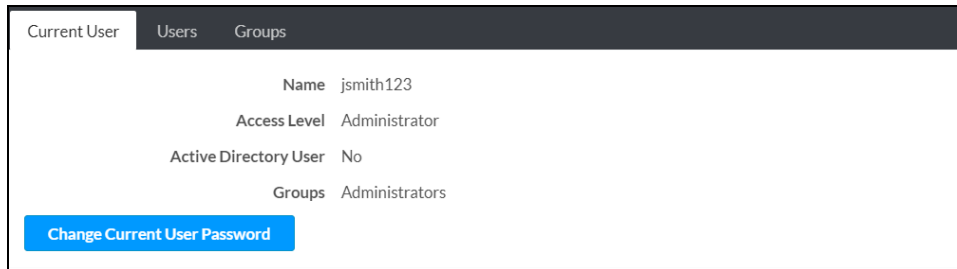

Current User	Users	Groups
Name	jsmith123	
Access Level	Administrator	
Active Directory User	No	
Groups	Administrators	

[Change Current User Password](#)

The following settings are displayed for the current user:

- **Name:** The chosen username
- **Access Level:** The access level granted to the user (**Administrator**, **Programmer**, **Operator**, **User**, or **Connect**)
- **Active Directory User:** Reports whether the current user is (**Yes**) or is not (**No**) authenticated through Active Directory® software

NOTE: A user must be added to an Active Directory group before the user may be selected as an active directory user. For more information, refer to [Groups on page 155](#).

- **Groups:** Any groups of which the current user is a member

Select **Change Current User Password** to change the password for the current user. The **Change Password** dialog box is displayed.

Change Password Dialog Box

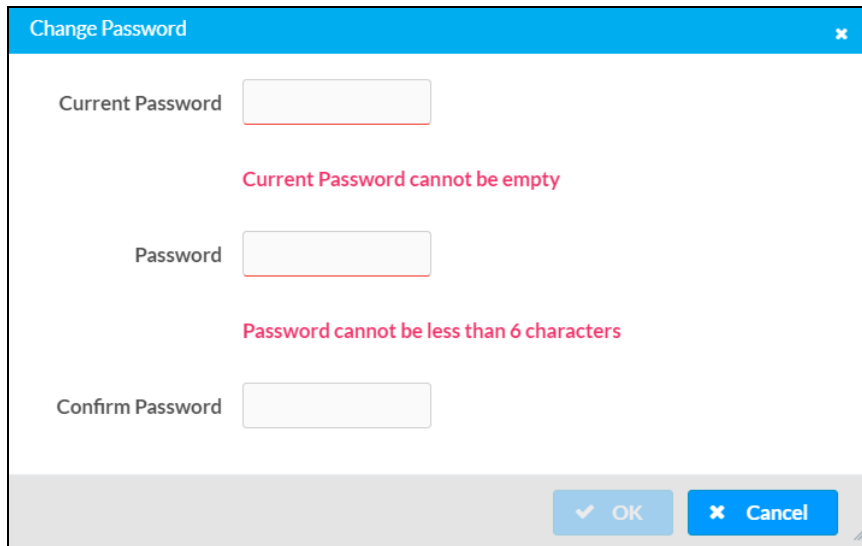

The dialog box titled "Change Password" contains three input fields: "Current Password", "Password", and "Confirm Password". Below the "Current Password" field is a red error message: "Current Password cannot be empty". Below the "Password" field is a red error message: "Password cannot be less than 6 characters". At the bottom right, there are two buttons: "OK" (with a checkmark icon) and "Cancel" (with an 'x' icon).

Enter the existing password in the **Current Password** field. Then, enter a new password in the **Password** field, and reenter the password in the **Confirm Password** field.

Select **OK** to save the new password, or select **Cancel** to cancel the change.

Users

Select the **Users** tab to view and edit information for the touch screen users.

Users Tab

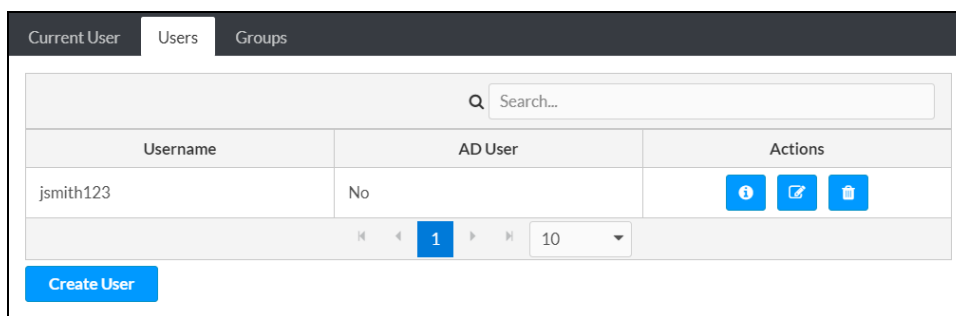

The interface shows three tabs: "Current User", "Users", and "Groups". The "Users" tab is active. It features a search bar with a magnifying glass icon and the text "Search...". Below the search bar is a table with the following columns: "Username", "AD User", and "Actions". The table contains one row with the following data: "jsmith123", "No", and three action icons (info, edit, delete). Below the table is a pagination bar showing "1" of "10" items. At the bottom left, there is a "Create User" button.

Enter text into the **Search Users** field to find and display users that match the search term(s).

Touch screen users are listed in table format. The following information is displayed for each touch screen user:

- **Username:** The chosen username
- **AD User:** Reports whether the user is (**Yes**) or is not (**No**) authenticated through Active Directory

NOTE: A user must be added to an Active Directory group before the user may be selected as an active directory user. For more information, refer to [Groups on page 155](#).

If the touch screen users span multiple pages, use the navigation arrows on the bottom of the page to move forward or backward through the pages, or select a page number to navigate to that page. Additionally, the number of users displayed on each page may be set to 5, 10, or 20 users.

An **Actions** column is also provided for each user that allows various actions to be performed. The following selections may be selected from the **Actions** column.

User Details

Select the information button  in the **Actions** column to view information for the selected user. The **User Details** pop-up dialog box is displayed.

User Details Dialog Box

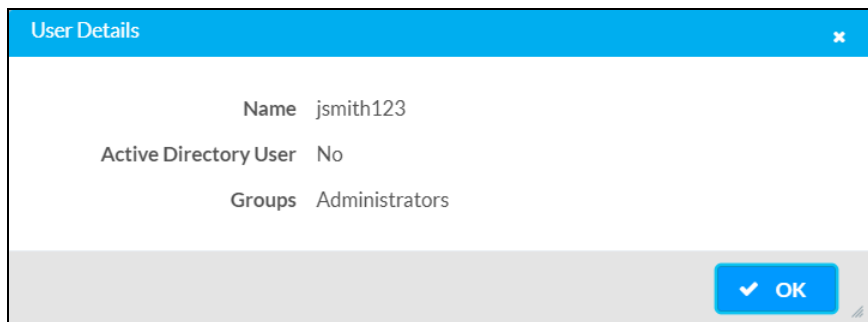

The following settings are displayed for the current user:

- **Name:** The chosen username
- **Active Directory User:** Reports whether the user is (**Yes**) or is not (**No**) authenticated through Active Directory
- **Groups:** Lists any groups that contain the user

Select **OK** to return to the **Authentication Management > Users** page.

Update User

Select the editing button  in the **Actions** column to edit settings for the selected user. The **Update User** dialog box is displayed.

Update User Dialog Box

The screenshot shows a dialog box titled "Update User". It contains the following elements:

- Name:** jsmith123
- Active Directory User:** A toggle switch that is currently turned off.
- Password:** An empty text input field. Below it, a red error message reads: "Password cannot be less than 6 characters".
- Confirm Password:** An empty text input field.
- Groups:** A dropdown menu with "Administrators" selected.
- Buttons:** "OK" (with a checkmark icon) and "Cancel" (with an 'X' icon).

The following **Update User** settings may be viewed or configured:

- **Name:** The chosen username
- **Active Directory User:** Turn on the toggle to use authentication via Active Directory for the selected user.
- **Password:** Enter a new password for the selected user.
- **Confirm Password:** Reenter the password provided in the **Password** field.
- **Groups:** Add the user to one or more groups. For more information, refer to [Groups on page 155](#).

NOTE: A user must be added to an Active Directory group to be selected as an Active Directory user.

Select **OK** to save any changes and to return to the **Authentication Management > Users** page. Select **Cancel** to cancel any changes.

Delete User

Select the trashcan icon  in the **Actions** column to delete the user.

A pop-up dialog box is displayed asking whether the user should be deleted. Select **Yes** to delete the user or **No** to cancel deleting the user.

Create User

Select **Create User** at the bottom of the page to create a new touch screen user. The **Create User** dialog box is displayed.

Create User Dialog Box

The screenshot shows a 'Create User' dialog box with the following elements:

- Name:** An empty text input field with a red error message below it: "Username cannot be empty".
- Active Directory User:** A toggle switch that is currently turned off.
- Password:** An empty text input field with a red error message below it: "Password cannot be less than 6 characters".
- Confirm Password:** An empty text input field.
- Groups:** A dropdown menu with "Choose" selected and a red error message below it: "Group Must be selected".
- Buttons:** "OK" and "Cancel" buttons at the bottom right.

Use the following settings to create a new user:

- **Name:** Enter a username.
- **Active Directory User:** Turn on the toggle to use authentication via Active Directory for the user.
- **Password:** Enter a password for the user.
- **Confirm Password:** Reenter the password provided in the **Password** field.
- **Groups:** Add the user to one or more groups. For more information, refer to [Groups on page 155](#).

NOTE: A user must be added to an Active Directory group to be selected as an Active Directory user.

Select **OK** to save any changes and to return to the **Authentication Management > Users** page. Select **Cancel** to cancel creating a new user.







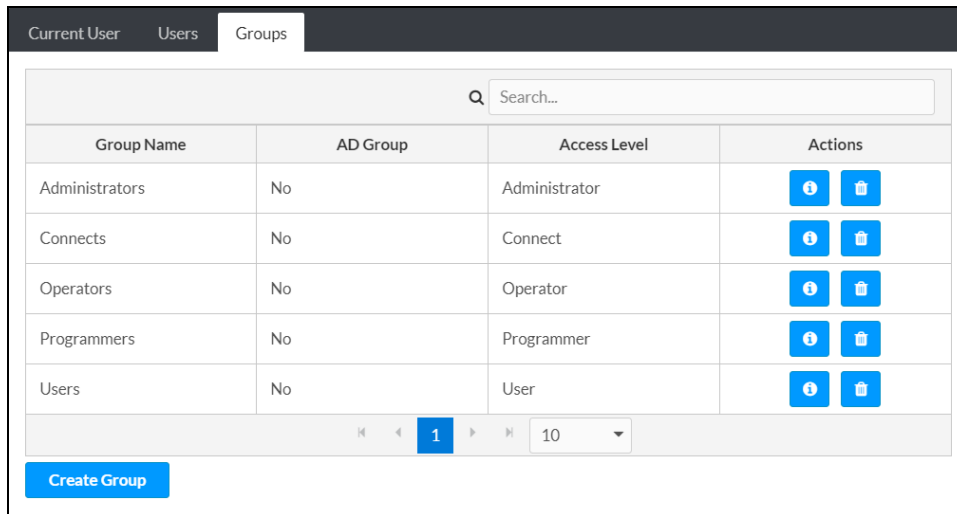



Groups

Select the **Groups** tab to view and edit settings for touch screen groups. Touch screen groups are used to group users by access level and Active Directory authentication settings.

Groups Tab



The screenshot shows a web interface with a dark header containing tabs for 'Current User', 'Users', and 'Groups'. The 'Groups' tab is active. Below the header is a search bar with a magnifying glass icon and the text 'Search...'. A table with four columns is displayed: 'Group Name', 'AD Group', 'Access Level', and 'Actions'. The table contains five rows of data. At the bottom of the table, there are navigation arrows, a page number '1', and a dropdown menu showing '10'. A blue 'Create Group' button is located at the bottom left of the interface.

Group Name	AD Group	Access Level	Actions
Administrators	No	Administrator	 
Connects	No	Connect	 
Operators	No	Operator	 
Programmers	No	Programmer	 
Users	No	User	 

Enter text in to the **Search Groups** field to find and display groups that match the search term (s).

Touch screen groups are listed in table format. The following information is displayed for each touch screen group:

- **Group Name:** The chosen group name
- **AD Group:** Reports whether the group is (**Yes**) or is not (**No**) authenticated through Active Directory

NOTE: Active Directory provides an additional layer of authentication for touch screen groups and users. Active directory group and user names are stored in the touch screen console along with a unique SID (security identifier). When an Active Directory user attempts to authenticate against the console, the console first checks the user credentials. If the Active Directory authentication is successful, Active Directory queries the console for the user or group's SID. The user is granted access to the touch screen only if at least one SID match is found.

- **Access Level:** The access level for the selected group (**Administrator, Programmer, Operator, User, or Connect**)

If the touch screen groups span multiple pages, use the navigation arrows on the bottom of the page to move forward or backward through the pages, or select a page number to navigate to that page. Additionally, the number of groups displayed on each page may be set to 5, 10, or 20 users.

An **Actions** column is also provided for each group that allows various actions to be performed. The following selections may be selected from the **Actions** column.

Group Details

Select the information button  in the **Actions** column to view information for the selected group. The **Group Details** dialog box is displayed.

Group Details Dialog Box

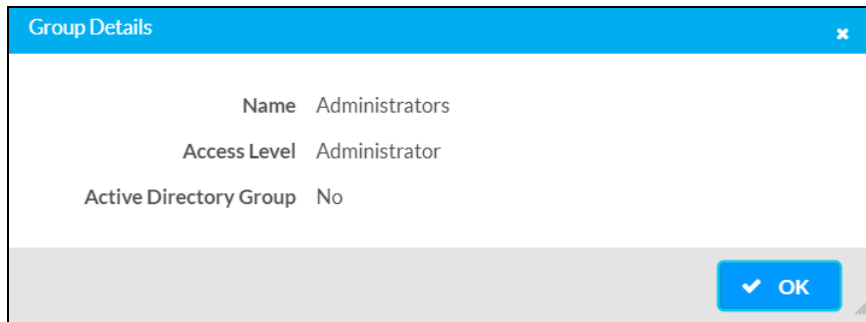

The following settings are displayed for the current group:

- **Name:** The chosen group name

NOTE: If authenticating with Active Directory, do not enter the domain name for the Active Directory group in the **Name** field. If this information is being entered via console commands, omit `domain\local` from the command (for example, `adddomaing -n:crestron -L:A` instead of `adddomaing -n:domain.local\crestron -L:A`).

- **Access Level:** The access level of the group and its users
- **Active Directory User:** Reports whether the group is (**Yes**) or is not (**No**) authenticated through Active Directory

Select **OK** to return to the **Authentication Management > Groups** page.

Delete Group

Select the trashcan icon  in the **Actions** column to delete the group.

A pop-up dialog box is displayed asking whether the group should be deleted. Select **Yes** to delete the group or **No** to cancel deleting the group.

Create Group

Select **Create Group** at the bottom of the page to create a new touch screen group. The **Create Group** dialog box is displayed.

Create Group Dialog Box

The screenshot shows a 'Create Group' dialog box with the following elements:

- Name:** An empty text input field with a red border and a red error message below it: "Group Name field cannot be empty".
- Access Level:** A dropdown menu currently set to "Administrator".
- Active Directory Group:** A toggle switch that is currently turned off.
- Buttons:** "OK" and "Cancel" buttons at the bottom right.

Use the following settings to create a new group:

- **Name:** Enter a group name.
- **Access Level:** Select an access level for the group and its users from the drop-down menu.
- **Active Directory Group:** Turn on the toggle to use authentication via Active Directory for the group.

Select **OK** to save any changes and to return to the **Authentication Management > Groups** page. Select **Cancel** to cancel creating a new group.

802.1x Configuration

Select the **802.1x Configuration** tab on the top left of the configuration interface to display selections for configuring IEEE 802.1X network authentication for touch screen security.

802.1x Configuration Tab Selections

802.1x Configuration

IEEE 802.1x Authentication

Authentication Method

Domain

Username

Password

Enable Authentication Server Validation

Select Trusted Certificate Authoritie(s)

- AAA Certificate Services
- AC RAIZ FNMT-RCM
- ACCVRAIZ1
- Actalis Authentication Root CA
- AffirmTrust Commercial
- AffirmTrust Networking
- AffirmTrust Premium ECC
- AffirmTrust Premium
- Amazon Root CA 1
- Amazon Root CA 2
- Amazon Root CA 3
- Amazon Root CA 4
- Atos TrustedRoot 2011
- Autoridad de Certificacion Firmaprofesional CIF A62634068

Expand the **802.1x Configuration** accordion to configure the following settings:

- **IEEE 802.1x Authentication:** Turn on the toggle to use 802.1X authentication for the touch screen.
- **Authentication Method:** Select an 802.1X authentication method (**EAP-TLS Certificate** or **EAP MSCHAP V2- password**) from the drop-down menu.
- **Domain:** If **EAP MSCHAP V2- password** is selected for **Authentication Method**, enter a domain name that is required for authentication.

- **Username:** If **EAP MSCHAP V2- password** is selected for **Authentication Method**, enter a username that is required for authentication.
- **Password:** If **EAP MSCHAP V2- password** is selected for **Authentication Method**, enter a password that is required for authentication.
- **Enable Authentication Server Validation:** Turn on the toggle to use server validation for increased security.
- **Select Trusted Certificate Authorities:** Select trusted CAs (Certificate Authorities) from the provided CAs to be used for server validation:
 - Select the check box to the left of a CA to select it as a trusted CA.
 - Enter a search term into the text field at the top of the CA menu to search for and display CAs that match the search term.
 - Select the check box to the left of the search field at the top of the CA menu to select all CAs as trusted CAs.

Select **Manage Certificates** from the **Action** menu to add or remove CAs from the list. The **Manage Certificates** dialog box is displayed with the **Root** tab selected.

Manage Certificates Dialog Box - Root Tab

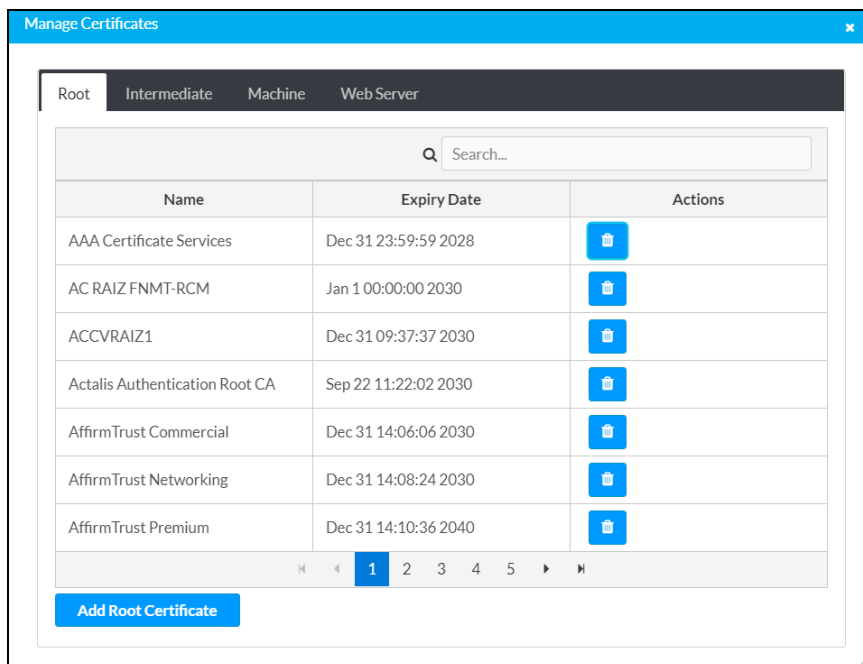

Select the tabs near the top of the page to switch between the different types of CAs (**Root**, **Intermediate**, **Machine**, or **Web Server**). The same settings are provided for each type of CA.

Type a search term into the **Search...** text field to search for and display CAs that match the search term.

The following information is provided for each type of CA:

- **Name:** The CA name
- **Expiry Date:** The date and time that the CA is set to expire

If the CAs span multiple pages, use the navigation arrows on the bottom of the page to move forward or backward through the pages, or select a page number to navigate to that page.

Select the trashcan button  in the **Actions** column for a CA to delete it. A pop-up dialog box is displayed asking if the CA should be deleted. Select **Yes** to delete the certificate or **No** to cancel.

Select **Add [Type] Certificate** to add a CA of one of the four available types (**Root**, **Intermediate**, **Machine**, or **Web Server**) to the list of CAs. The **Add Certificate** pop-up dialog box is displayed.

Add Certificate Dialog Box

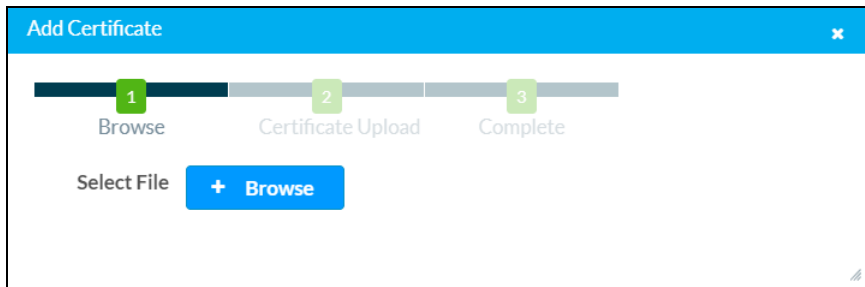

To add a new certificate:

1. Select **Browse**.
2. Navigate to the CA file on the host computer.
3. Select the CA file, and then select **Open**.
4. Select **Load** to load the CA file to the touch screen. The upload progress is shown in the dialog box.
5. Once the touch screen has completed the upload, select **OK**.

Select the **x** button to close the **Add Certificate** dialog box at any time during the upload process. Selecting the **x** button before the CA file is uploaded to the touch screen cancels the upload.

Select the **x** button to close the **Manage Certificates** dialog box and to return to the **802.1x Authentication** page.

Application Selection

The touch screen ships with a variety of preinstalled applications that provide out-of-the-box functionality. Once an application has been selected, it downloads from the cloud and installs on the touch screen automatically.

The following applications ship with the touch screen:

- Crestron general web application¹
- [Crestron room scheduling](#) application
- [Crestron Home™ OS](#) user control application
- [22 Miles® ADSign](#) application²
- [Appspace® digital signage](#) application
- [AskCody® room scheduling](#) application
- [Door Tablet® room scheduling](#) application
- [EMS Software® room scheduling](#) application
- [Envoy® room scheduling](#) application
- [Gingco.net™ room scheduling](#) application
- [iOffice® room scheduling](#) application
- [Indoor Finders® room scheduling](#) application
- [Kardham Digital® room scheduling](#) application
- [Korbyt™ room scheduling](#) application
- [KuiqMeeting room scheduling](#) application
- [Matrix Booking® room scheduling](#) application
- [Microsoft Teams® online meeting solution](#) application

NOTE: A Crestron Flex Microsoft Teams UC system must be configured prior to configuring the Microsoft Teams application on the touch screen. For more information, refer to the [UC Video Conference Systems for Microsoft Teams Supplemental Guide](#).

- [Microsoft Teams Scheduling Panels](#) application
- [NexBoard room scheduling](#) application
- [New Wave Apps® room scheduling](#) application
- [NFS™ Rendezvous room scheduling](#) application
- [OfficeSpace® room scheduling](#) application
- [PADS4 room scheduling](#) application
- [Pepperdash® room scheduling](#) application
- [Robin® room scheduling](#) application

- [SharingCloud™ room scheduling](#) application
- [Smartway2® room scheduling](#) application
- [Space Connect™ room scheduling](#) application
- [SpacelQ® room scheduling](#) application
- [Telelogos® Meeting4Display room scheduling](#) application
- [Teem® room scheduling](#) application
- [Zoom Rooms™ conferencing control and Zoom™ room scheduling](#) application

NOTE: Support for additional applications will be provided by future firmware updates.

The touch screen runs only one app, which is selected at setup. Only the apps approved and delivered by Crestron may run on the touch screen.

NOTE: Additional subscriptions and/or licenses may be required. Refer to each provider's website for details about the capabilities and requirements of its scheduling application and services.

For more information on using and setting up each application, refer to the provider's website.

Note:

1. The Crestron general web functionality allows a user to run a custom web application on the touch screen from a web server. The URL for the web application must be provided within the web configuration interface and must use the HTTPS protocol. For more information on selecting the application, refer to [Applications on page 147](#). For more information on using the Crestron general web functionality with a TSW-70 series light bar, refer to [online help answer ID 1001103](#).

Connect to XiO Cloud Service

The [XiO Cloud® service](#) allows supported devices across an enterprise to be managed and configured from one central and secure location in the cloud. Supported Crestron® devices are configured to connect to the service out of the box.

Use of the service requires a registered XiO Cloud account. To register for an XiO Cloud account, refer to www.crestron.com/Support/Tools/Licensing-Registration/XiO-Cloud-Registration-Room-Licenses.

NOTE: The device may be disconnected from the XiO Cloud service by navigating to the **Cloud Services** tab in Crestron Toolbox™ software (**Functions > Device Info > Cloud Services**). For details, refer to the Crestron Toolbox help file.

To connect the device to the XiO Cloud service:

1. Record the MAC address and serial number that are labeled on the shipping box or the device. The MAC address and serial number are required to add the device to the XiO Cloud service.

NOTE: If the device has multiple MAC addresses, use the MAC address that is providing the primary connection back to the network. For most devices, the Ethernet MAC address should be used. However, if your device is connecting to the network over a different protocol (such as Wi-Fi® communications), use the MAC address for that protocol instead.

2. Log in to your XiO Cloud account at portal.crestron.io.
3. Claim the device to the XiO Cloud service as described in the [XiO Cloud User Guide](#).

Select the device from the cloud interface to view its status and settings. The device may now also be managed and assigned to a group or room. For more information, refer to the [XiO Cloud User Guide](#).

NOTE: For XiO Cloud accounts with room-based licenses, the device must be added to a licensed room before its status and settings can be viewed.

Operation

The touch screen is controlled by using its capacitive touch screen display. The touch screen supports gesturing and swiping controls to perform various functions. Supported touch controls vary by application or program.





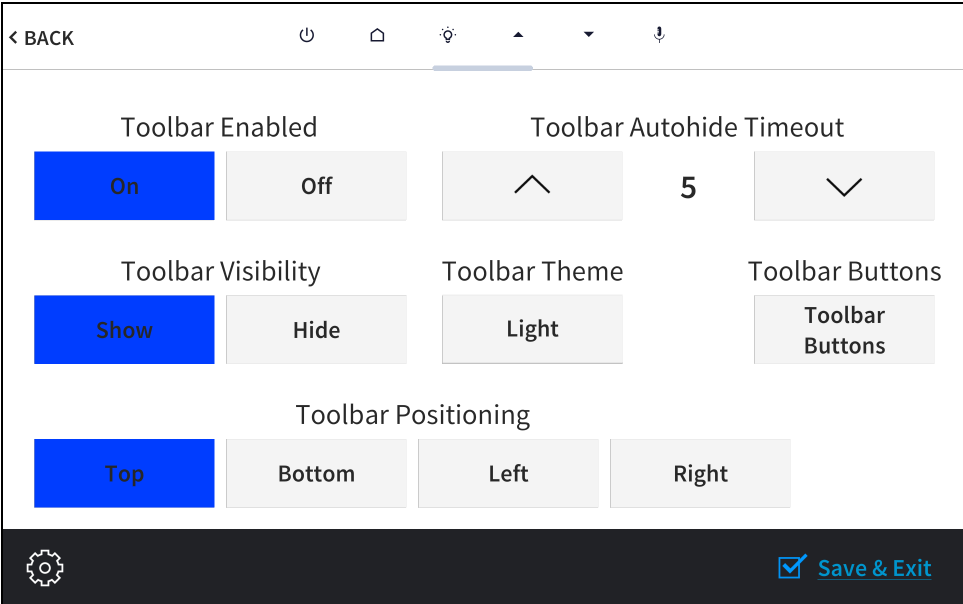

The virtual toolbar is used to perform basic device functions if it has been enabled. By default, the virtual toolbar can be accessed by swiping down on the tab located at the top of the screen. The toolbar can be hidden by swiping up on the tab or is hidden automatically after a set timeout duration.

On-screen Toolbar Screen (with Virtual Toolbar)



The following virtual buttons are provided by default and can be used to control the touch screen or the loaded application or program (if supported). Each button can be manually enabled or disabled in the local configuration pages.

NOTE: Virtual button functionality can be custom programmed using a Crestron control system.

- **Power**  : Powers the touch screen off.
- **Home**  : Returns to the home page of the application or program.
- **Lighting**  : Navigates to lighting controls in the application or program.
- **Up**  : Moves up a page in the application or program.
- **Down**  : Moves down a page in the application or program.
- **Microphone**  : Enables or disables the microphone functionality.

For more information on configuring the virtual toolbar, refer to [Virtual Toolbar on page 106](#).

Resources

The following resources are provided for the TS-70 Series.

NOTE: You may need to provide your Crestron.com web account credentials when prompted to access some of the following resources.

Crestron Support and Training

- [Crestron True Blue Support](#)
- [Crestron Resource Library](#)
- [Crestron Online Help \(OLH\)](#)
- [Crestron Training Institute \(CTI\) Portal](#)

Programmer and Developer Resources

- help.crestron.com: Provides help files for Crestron programming tools such as SIMPL, SIMPL#, and Crestron Toolbox™ software
- developer.crestron.com: Provides developer documentation for Crestron APIs, SDKs, and other development tools

Related Documentation

- [.AV Framework™ Software User Guides](#)
- [Crestron Fusion® Software Help File](#)
- [Crestron Home™ OS User Guide](#)
- [Crestron Programming Design Guide](#)
- [Crestron Room Scheduling Application Operations Guide](#)
- [Crestron Room Scheduling Application Programming Guide](#)
- [Crestron Room Scheduling Application User Guide](#)
- [TS-70 and TSW-70 Series Touch Screens Security Reference Guide](#)
- [XiO Cloud User Guide](#)

