

Crestron **DM-RMC-4K-100-C**  
4K DigitalMedia 8G+™ Receiver  
& Room Controller 100

---

Operations & Installation Guide



## Important Safety Instructions

- Read these instructions.
- Keep these instructions.
- Heed all warnings.
- Follow all instructions.
- Do not use this apparatus near water.
- Clean only with dry cloth.
- Do not block any ventilation openings. Install in accordance with the manufacturer's instructions.
- Do not install near any heat sources such as radiators, heat registers, stoves, or other apparatus (including amplifiers) that produce heat.
- Do not defeat the safety purpose of the polarized or grounding-type plug. A polarized plug has two blades with one wider than the other. A grounding-type plug has two blades and a third grounding prong. The wide blade or the third prong are provided for your safety. If the provided plug does not fit into your outlet, consult an electrician for replacement of the obsolete outlet.
- Protect the power cord from being walked on or pinched particularly at plugs, convenience receptacles, and the point where they exit from the apparatus.
- Only use attachments/accessories specified by the manufacturer.
- Use only with the cart, stand, tripod, bracket or table specified by the manufacturer or sold with the apparatus. When a cart is used, use caution when moving the cart/apparatus combination to avoid injury from tip-over. 
- Unplug this apparatus during lightning storms or when unused for long periods of time.
- Refer all servicing to qualified service personnel. Servicing is required when the apparatus has been damaged in any way, such as power-supply cord or plug is damaged, liquid has been spilled or objects have fallen into the apparatus, the apparatus has been exposed to rain or moisture, does not operate normally, or has been dropped.
- Disconnect power prior to connecting or disconnecting equipment.
- Do not install in direct sunlight.
- The apparatus must be installed in a way that the power cord can be removed either from the wall outlet or from the device itself in order to disconnect the mains power.
- Prevent foreign objects from entering the device.

### WARNING:

---

TO REDUCE THE RISK OF FIRE OR ELECTRIC SHOCK, DO NOT EXPOSE THIS APPARATUS TO RAIN OR MOISTURE. THE APPARATUS SHALL NOT BE EXPOSED TO DRIPPING OR SPLASHING. OBJECTS FILLED WITH LIQUIDS, SUCH AS VASES, SHOULD NOT BE PLACED ON THE APPARATUS.

---

### WARNING:

---

TO PREVENT ELECTRIC SHOCK, DO NOT REMOVE COVER. THERE ARE NO USER SERVICEABLE PARTS INSIDE. ONLY QUALIFIED SERVICE PERSONNEL SHOULD PERFORM SERVICE.

---

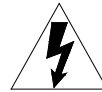

The lightning flash with arrowhead symbol, within an equilateral triangle, is intended to alert the user to the presence of uninsulated "dangerous voltage" within the product's enclosure that may be of sufficient magnitude to constitute a risk of electric shock to persons.



The exclamation point within an equilateral triangle is intended to alert the user to the presence of important operating and maintenance (servicing) instructions in the literature accompanying the appliance.

### IMPORTANT:

---

This device can be used with Class 2 output wiring.

---

## Regulatory Compliance

This product is Listed to applicable UL Standards and requirements by Underwriters Laboratories Inc.



As of the date of manufacture, the DM-RMC-4K-100-C has been tested and found to comply with specifications for CE marking.



---

## Federal Communications Commission (FCC) Compliance Statement

This device complies with part 15 of the FCC Rules. Operation is subject to the following conditions:

(1) This device may not cause harmful interference and (2) this device must accept any interference received, including interference that may cause undesired operation.

**CAUTION:** Changes or modifications not expressly approved by the manufacturer responsible for compliance could void the user's authority to operate the equipment.

**NOTE:** This equipment has been tested and found to comply with the limits for a Class B digital device, pursuant to part 15 of the FCC Rules. These limits are designed to provide reasonable protection against harmful interference in a residential installation. This equipment generates, uses and can radiate radio frequency energy and, if not installed and used in accordance with the instructions, may cause harmful interference to radio communications. However, there is no guarantee that interference will not occur in a particular installation. If this equipment does cause harmful interference to radio or television reception, which can be determined by turning the equipment off and on, the user is encouraged to try to correct the interference by one or more of the following measures:

- Reorient or relocate the receiving antenna
- Increase the separation between the equipment and receiver
- Connect the equipment into an outlet on a circuit different from that to which the receiver is connected
- Consult the dealer or an experienced radio/TV technician for help

---

## Industry Canada (IC) Compliance Statement

CAN ICES-3(B)/NMB-3(B)

---

This device includes an aggregation of separate independent works that are each generally copyrighted by Crestron Electronics, Inc., with all rights reserved. One of those independent works, Linux Bridge Project, is copyrighted under the GNU GENERAL PUBLIC LICENSE, Version2, reproduced in "6BGNU General Public License" on page 25, where the corresponding source code is available at: <ftp://ftp.crestron.com/gpl>.

The specific patents that cover Crestron products are listed at [patents.crestron.com](http://patents.crestron.com).

Crestron, the Crestron logo, Crestron e-Control, Crestron Studio, Crestron Toolbox, DigitalMedia, DigitalMedia 8G, DigitalMedia 8G+, DM, DM 8G, and DM 8G+ are either trademarks or registered trademarks of Crestron Electronics, Inc. in the United States and/or other countries. Dolby and Dolby Digital are either trademarks or registered trademarks of Dolby Laboratories in the United States and/or other countries. DTS, DTS-HD, and DTS-HD Master Audio are either trademarks or registered trademarks of DTS, Inc. in the United States and/or other countries. HDBaseT and the HDBaseT Alliance logo are either trademarks or registered trademarks of the HDBaseT Alliance in the United States and/or other countries. HDMI and the HDMI logo are either trademarks or registered trademarks of HDMI Licensing LLC in the United States and/or other countries. Other trademarks, registered trademarks, and trade names may be used in this document to refer to either the entities claiming the marks and names or their products. Crestron disclaims any proprietary interest in the marks and names of others. *Crestron is not responsible for errors in typography or photography.*

This document was written by the Technical Publications department at Crestron.  
©2014 Crestron Electronics, Inc.



# Contents

<b>4K DigitalMedia 8G+ Receiver &amp; Room Controller 100: DM-RMC-4K-100-C</b>	<b>1</b>
Introduction .....	1
Features and Functions .....	1
Applications .....	4
Specifications .....	5
Physical Description .....	8
Setup .....	13
Network Wiring .....	13
Identity Code .....	14
Installation .....	14
Hardware Hookup .....	16
Uploading and Upgrading .....	18
Establishing Communication .....	18
Firmware .....	19
IP Table Configuration .....	20
Problem Solving .....	21
Troubleshooting .....	21
Reference Documents .....	22
Further Inquiries .....	22
Future Updates .....	23
Return and Warranty Policies .....	24
Merchandise Returns / Repair Service .....	24
Crestron Limited Warranty .....	24
GNU General Public License .....	25



# 4K DigitalMedia 8G+ Receiver & Room Controller 100: DM-RMC-4K-100-C

---

## Introduction

The DM-RMC-4K-100-C provides a simple 1-box interface solution for a single display device as part of a complete Crestron® DigitalMedia™ system. It functions as a DM 8G+™ receiver and control interface, providing a single HDMI® output along with Ethernet, RS-232, and IR control ports. In addition to DM 8G+, it is also compatible with HDBaseT®, allowing it to be connected directly to any HDBaseT certified source. Its compact, low-profile design allows the DM-RMC-4K-100-C to be installed discreetly behind a flat panel display or above a ceiling mounted projector. It connects to the head end or source location using a single CAT5e or Crestron DM 8G® cable.<sup>1</sup>

## Features and Functions

- DigitalMedia 8G+™ receiver and display controller
- DM 8G+ input supports up to 330 foot (100 meter) cable length<sup>1</sup>
- Connects to a DM® switcher or transmitter (each sold separately) over one CAT5e or Crestron DM 8G cable<sup>1</sup>
- HDBaseT certified, which enables direct connection to other HDBaseT certified equipment
- Provides one HDMI or DVI display output<sup>2</sup>
- Handles video resolutions up to 4K Ultra HD and 4K DCI<sup>1</sup>
- Handles 3D video and Deep Color

*(Continued on following page)*

1. The maximum cable length for DigitalMedia 8G+ (DM 8G+) or HDBaseT is 330 feet (100 meters) for resolutions up to 1600 x 1200 and 1920 x 1200 (including 1080p60 and 2K) using DM-CBL-8G DigitalMedia 8G™ cable, DM-CBL DigitalMedia cable, DM-CBL-D DigitalMedia D cable, or third-party CAT5e (or better) UTP or STP. For higher resolutions (including 4K), the maximum wire length is 230 feet (70 meters) using DM-CBL-8G or 165 feet (50 meters) using DM-CBL, DM-CBL-D, or CAT5e. Shielded cable and connectors are recommended to safeguard against unpredictable environmental electrical noise, which may impact performance at resolutions above 1080p. For complete system design guidelines, refer to the DigitalMedia Design Guide (Doc. 4546) at [www.crestron.com/manuals](http://www.crestron.com/manuals). DM 8G+ is compatible with HDBaseT Alliance specifications for connecting to HDBaseT compliant equipment. All wire and cables are sold separately.
2. The HDMI output requires an appropriate adapter or interface cable to accommodate a DVI signal. CBL-HD-DVI interface cables are sold separately.

## Features and Functions

*(Continued)*

- Handles Dolby® TrueHD, DTS-HD®, and uncompressed 7.1 linear PCM audio
- HDCP compliant
- Provides a 10BASE-T/100BASE-TX Ethernet LAN connection
- Enables device control via CEC, IR, RS-232, and Ethernet
- Compatible with USB-EXT-DM USB Extender Modules (sold separately)
- Allows quick, easy setup and diagnostics
- Low-profile surface mount design
- Powered via the DM connection or local power pack (included)<sup>1</sup>

### **4K Ultra HD**

Using DM 8G+ technology, the DM-RMC-4K-100-C supports the transport of 4K Ultra HD and 4K DCI video signals. Support for 4K video ensures support for the latest generation of ultra high resolution computers and monitors with resolutions over 1080p and 2K.

### **DigitalMedia 8G+**

DigitalMedia 8G+ provides a true 1-wire transport for moving high-definition video, audio, power, and Ethernet over low-cost twisted pair cable without compression or repeaters. Engineered for ultra high bandwidth and ultimate scalability, DM 8G+ handles uncompressed video beyond high definition with support for Full HD 1080p, 2K, 4K, 3D, Deep Color, and HDCP. Audio capabilities include support for high bitrate 7.1 audio formats such as Dolby TrueHD and DTS-HD Master Audio™ as well as uncompressed linear PCM. All signals are transported over one 8-conductor twisted pair cable (sold separately), supporting distances up to 330 feet (100 meters) using Crestron DM 8G cable or CAT5e.<sup>2</sup>

### **HDBaseT Certified**

DigitalMedia 8G+ technology is designed using HDBaseT Alliance specifications, ensuring interoperability with other HDBaseT certified products. Via its DM 8G+ input, the DM-RMC-4K-100-C can be connected directly to an HDBaseT compliant source without requiring a DM transmitter. HDBaseT connectivity through the DM-RMC-4K-100-C converges uncompressed Full HD and 4K digital video, audio, Ethernet, power, and control signals through a single CAT5e or CAT6 cable over distances up to 330 feet (100 meters).<sup>2</sup>

1. Receiving Power over DM (PoDM) or Power over HDBaseT (PoH) requires connection to a switcher or other equipment that has a PoDM or PoH PSE (Power Sourcing Equipment) port. Any wiring that is connected to a PoDM or PoH PSE port is for intra-building use only and should not be connected to a line that runs outside of the building in which the PSE is located.
2. The maximum cable length for DigitalMedia 8G+ (DM 8G+) or HDBaseT is 330 feet (100 meters) for resolutions up to 1600 x 1200 and 1920 x 1200 (including 1080p60 and 2K) using DM-CBL-8G DigitalMedia 8G cable, DM-CBL DigitalMedia cable, DM-CBL-D DigitalMedia D cable, or third-party CAT5e (or better) UTP or STP. For higher resolutions (including 4K), the maximum wire length is 230 feet (70 meters) using DM-CBL-8G or 165 feet (50 meters) using DM-CBL, DM-CBL-D, or CAT5e. Shielded cable and connectors are recommended to safeguard against unpredictable environmental electrical noise, which may impact performance at resolutions above 1080p. For complete system design guidelines, refer to the DigitalMedia Design Guide (Doc. 4546). DM 8G+ is compatible with HDBaseT Alliance specifications for connecting to HDBaseT compliant equipment. All wire and cables are sold separately.



### ***Multimedia Display Interface***

A single HDMI digital AV output port is provided on the DM-RMC-4K-100-C for connection to a display or other device. The HDMI output can also handle DVI signals using an appropriate adapter or interface cable.<sup>1</sup>

A single cable connects the DM-RMC-4K-100-C to a DM switcher or transmitter (each sold separately) or to an HDBaseT source, transporting video, audio, control, networking, and power signals through one RJ-45 connection.<sup>2, 3</sup> Multiple DM-RMC-4K-100-Cs may be installed to handle each display in a multiroom distribution system, all fed from a central DM switcher. Or, a single DM-RMC-4K-100-C can be fed straight from a DM 8G+ or HDBaseT transmitter, affording a simple solution for extending a computer or AV signal to a single display.

### ***LAN Connectivity***

Along with high-definition AV and control, DigitalMedia also integrates high-speed Ethernet networking for a total signal distribution solution. The DM-RMC-4K-100-C includes a 10BASE-T/100BASE-TX Ethernet port, providing a convenient LAN connection for a local network device.

### ***Embedded Device Control***

The DM-RMC-4K-100-C includes built-in RS-232, IR, and Ethernet control ports to allow programmable control of the display device connected to it. It can also provide an alternative to such conventional control methods by harnessing the CEC (Consumer Electronics Control) signal embedded in HDMI. Through its connection to the control system, the DM-RMC-4K-100-C provides a gateway for controlling the display device through the HDMI connection, potentially eliminating the need for any dedicated control wires or IR emitters.

### ***USB Signal Extension (Optional)***

DigitalMedia allows for the routing of USB signals alongside video and audio. USB signal extension is enabled on the DM-RMC-4K-100-C by adding a USB-EXT-DM USB Extender Module (sold separately).

1. The HDMI output requires an appropriate adapter or interface cable to accommodate a DVI signal. CBL-HD-DVI interface cables are sold separately.
2. The maximum cable length for DigitalMedia 8G+ (DM 8G+) or HDBaseT is 330 feet (100 meters) for resolutions up to 1600 x 1200 and 1920 x 1200 (including 1080p60 and 2K) using DM-CBL-8G DigitalMedia 8G cable, DM-CBL DigitalMedia cable, DM-CBL-D DigitalMedia D cable, or third-party CAT5e (or better) UTP or STP. For higher resolutions (including 4K), the maximum wire length is 230 feet (70 meters) using DM-CBL-8G or 165 feet (50 meters) using DM-CBL, DM-CBL-D, or CAT5e. Shielded cable and connectors are recommended to safeguard against unpredictable environmental electrical noise, which may impact performance at resolutions above 1080p. For complete system design guidelines, refer to the DigitalMedia Design Guide (Doc. 4546). DM 8G+ is compatible with HDBaseT Alliance specifications for connecting to HDBaseT compliant equipment. All wire and cables are sold separately.
3. Receiving Power over DM (PoDM) or Power over HDBaseT (PoH) requires connection to a switcher or other equipment that has a PoDM or PoH PSE (Power Sourcing Equipment) port. Any wiring that is connected to a PoDM or PoH PSE port is for intra-building use only and should not be connected to a line that runs outside of the building in which the PSE is located.

### Low-Profile Installation

The DM-RMC-4K-100-C mounts conveniently on a wall, ceiling, or other flat surface. At just 1 inch (25 mm) deep, it fits easily behind a flat panel display or above a ceiling mounted projector. All connections and LED indicators are positioned on the sides, ensuring optimal access and visibility for a clean, serviceable installation. An array of indicators is provided for easy setup and troubleshooting.

### Applications

The diagram below shows a DM-RMC-4K-100-C in a standalone application. In this application, the DM-RMC-4K-100-C is used with a DM 8G+ transmitter such as the DM-TX-201-C (sold separately) and is not used with a DM switcher.

*DM-RMC-4K-100-C in a Standalone Application*

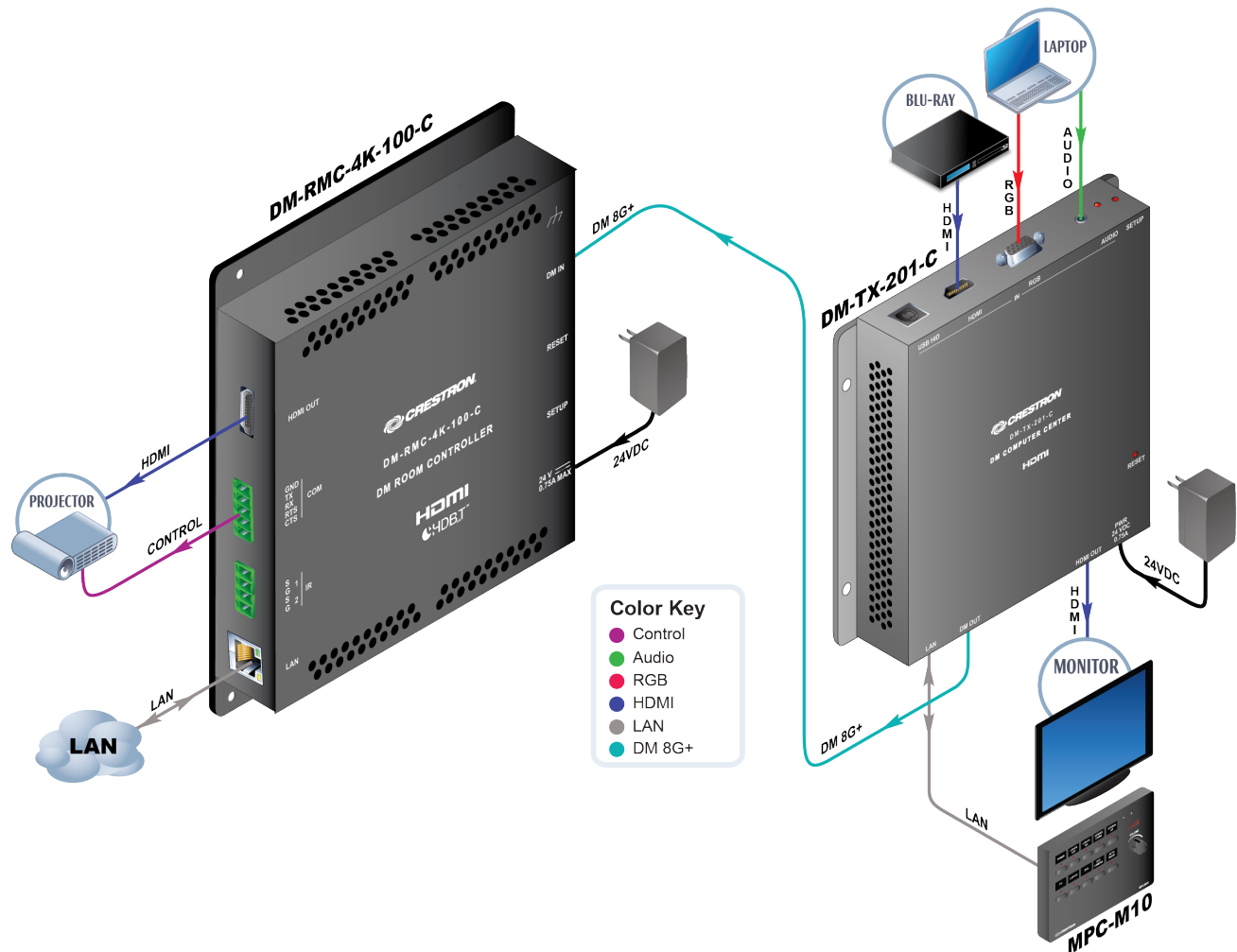

### Specifications

Specifications for the DM-RMC-4K-100-C are listed in the following table.

*DM-RMC-4K-100-C Specifications*

SPECIFICATION	DETAILS
Video	
Input Signal Types	DM 8G+ (DigitalMedia over one CAT5e twisted pair copper wire), HDBaseT <sup>1</sup>
Output Signal Types	HDMI, DVI <sup>2</sup>
Formats	DM 8G+, HDBaseT, and HDMI with Deep Color, 3D, and 4K; DVI; HDCP content protection support
Input Resolutions	
Progressive	640 x 480 @ 60 Hz 720 x 480 @ 60 Hz (480p) 720 x 576 @ 50 Hz (576p) 800 x 600 @ 60 Hz 848 x 480 @ 60 Hz 852 x 480 @ 60 Hz 854 x 480 @ 60 Hz 1024 x 768 @ 60 Hz 1024 x 852 @ 60 Hz 1024 x 1024 @ 60 Hz 1280 x 720 @ 50 Hz (720p50) 1280 x 720 @ 60 Hz (720p60) 1280 x 768 @ 60 Hz 1280 x 800 @ 60 Hz 1280 x 960 @ 60 Hz 1280 x 1024 @ 60 Hz 1360 x 768 @ 60 Hz 1365 x 1024 @ 60 Hz 1366 x 768 @ 60 Hz 1400 x 1050 @ 60 Hz 1440 x 900 @ 60 Hz 1600 x 900 @ 60 Hz 1600 x 1200 @ 60 Hz 1680 x 1050 @ 60 Hz 1920 x 1080 @ 24 Hz (1080p24) 1920 x 1080 @ 25 Hz (1080p25) 1920 x 1080 @ 50 Hz (1080p50) 1920 x 1080 @ 60 Hz (1080p60) 1920 x 1200 @ 60 Hz 2048 x 1080 @ 24 Hz 2048 x 1152 @ 60 Hz 2560 x 1440 @ 60 Hz 2560 x 1600 @ 60 Hz 3840 x 2160 @ 24 Hz 3840 x 2160 @ 25 Hz 3840 x 2160 @ 30 Hz 3840 x 2160 @ 50 Hz <sup>3</sup> 3840 x 2160 @ 60 Hz <sup>3</sup> 4096 x 2160 @ 24 Hz 4096 x 2160 @ 50 Hz <sup>3</sup> 4096 x 2160 @ 60 Hz <sup>3</sup> plus any other resolution allowed by HDMI up to 300 MHz pixel clock

*(Continued on following page)*

*DM-RMC-4K-100-C Specifications (Continued)*

SPECIFICATION	DETAILS
Video	
Input Resolutions (Continued)	
Interlaced	720 x 480 @ 30 Hz (480i) 720 x 576 @ 25 Hz (576i) 1920 x 1080 @ 25 Hz (1080i25) 1920 x 1080 @ 30 Hz (1080i30) plus any other resolution allowed by HDMI up to 300 MHz pixel clock
Output Resolutions	Matched to input
Audio	
Input Signal Type	DM 8G+, HDBaseT
Output Signal Type	HDMI
Formats	Dolby Digital®, Dolby Digital EX, Dolby Digital Plus, Dolby TrueHD, DTS®, DTS-ES, DTS 96/24, DTS-HD High Res, DTS-HD Master Audio, up to 8-channel PCM
Communications	
DigitalMedia	DM 8G+, HDCP management, EDID format management, CEC, PoDM, HDBaseT compliant
Ethernet	10BASE-T/100BASE-TX, auto-switching, auto-negotiating, auto-discovery, full/half duplex, DHCP
Power Requirements <sup>4</sup>	
Power Pack	0.75 A @ 24 Vdc; 100-240 Vac, 50/60 Hz power pack included
Power over DM (PoDM)	PoDM PD (Powered Device), capable of being powered by a PoDM PSE (Power Sourcing Equipment), conforms to IEEE 802.3af (802.3at Type 1) Class 3 (12.95 W) <sup>5</sup>
Power over HDBaseT (PoH)	PoH PD, capable of being powered by a PoH PSE, conforms to IEEE 802.3af (802.3at Type 1) Class 3 (12.95 W) <sup>5</sup>
Environmental	
Temperature	32° to 104°F (0° to 40°C)
Humidity	10% to 90% RH (non-condensing)
Heat Dissipation	29 Btu/h
Enclosure	
Chassis	Metal, black finish, with two integral mounting flanges, vented top and bottom
Mounting	Freestanding, surface mount, or attach to a single rack rail

*(Continued on following page)*

*DM-RMC-4K-100-C Specifications (Continued)*

SPECIFICATION	DETAILS
Dimensions	
Height	6.09 in (155 mm)
Width	5.68 in (145 mm)
Depth	1.02 in (26 mm)
Weight	17 oz (468 g)
Included Accessory	Universal 24 Vdc power pack
Available Accessories	
CBL Series	Crestron Certified Interface Cables
CNSP-XX	Custom Serial Interface Cable
DM-8G-CONN	DigitalMedia 8G Cable Connector
DM-8G-CONN-WG	DigitalMedia 8G Cable Connector with Wire Guide
DM-8G-CRIMP	Crimping Tool for DM-8G-CONN
DM-8G-CRIMP-WG	Crimping Tool for DM-8G-CONN-WG
DM-CBL-8G	DigitalMedia 8G Cable
IRP2	IR Emitter Probe
MP-WP Series	Media Presentation Wall Plates
MPI-WP Series	Media Presentation Wall Plates – International Version
USB-EXT-DM-LOCAL	USB Extender Module for Host
USB-EXT-DM-REMOTE	USB Extender Module for Devices

1. The maximum cable length for DigitalMedia 8G+ (DM 8G+) or HDBaseT is 330 feet (100 meters) for resolutions up to 1600 x 1200 and 1920 x 1200 (including 1080p60 and 2K) using DM-CBL-8G DigitalMedia 8G cable, DM-CBL DigitalMedia cable, DM-CBL-D DigitalMedia D cable, or third-party CAT5e (or better) UTP or STP. For higher resolutions (including 4K), the maximum wire length is 230 feet (70 meters) using DM-CBL-8G or 165 feet (50 meters) using DM-CBL, DM-CBL-D, or CAT5e. Shielded cable and connectors are recommended to safeguard against unpredictable environmental electrical noise, which may impact performance at resolutions above 1080p. For complete system design guidelines, refer to the DigitalMedia Design Guide (Doc. 4546). DM 8G+ is compatible with HDBaseT Alliance specifications for connecting to HDBaseT compliant equipment. All wire and cables are sold separately.
2. The HDMI output requires an appropriate adapter or interface cable to accommodate a DVI signal. CBL-HD-DVI interface cables are sold separately.
3. 4K support at 50/60 Hz with 4:2:0 color sampling will be enabled through a future firmware update.
4. A power pack, Power over DM (PoDM), or Power over HDBaseT (PoH) can be used to power the DM-RMC-4K-100-C.
5. References to the IEEE 802.3af and 802.3at standards are used to demonstrate that PoDM and PoH technology is similar in function to PoE and follows the same essential specifications. The DM-RMC-4K-100-C cannot be powered over Ethernet, and its DM IN port should not be connected directly to an Ethernet network or device.

## Physical Description

This section provides information on the connections, controls, and indicators available on the DM-RMC-4K-100-C.

### *DM-RMC-4K-100-C Physical View (Front)*

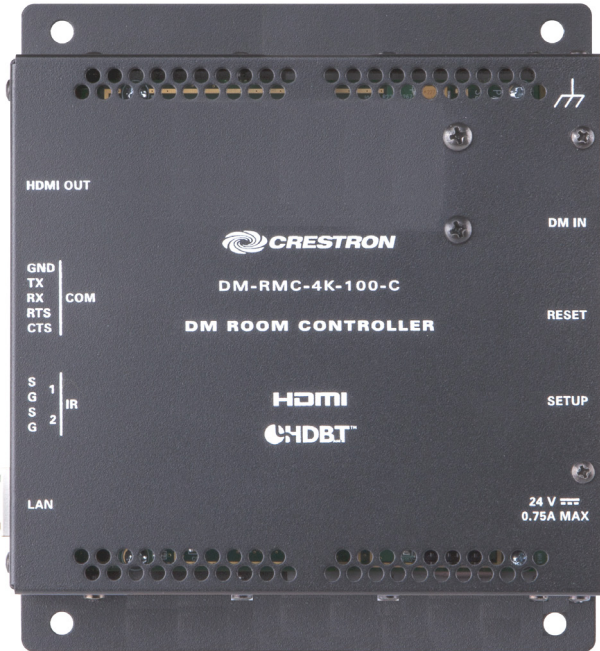

### *DM-RMC-4K-100-C Physical Views (Left and Right Side)*



*DM-RMC-4K-100-C Overall Dimensions (Front View)*

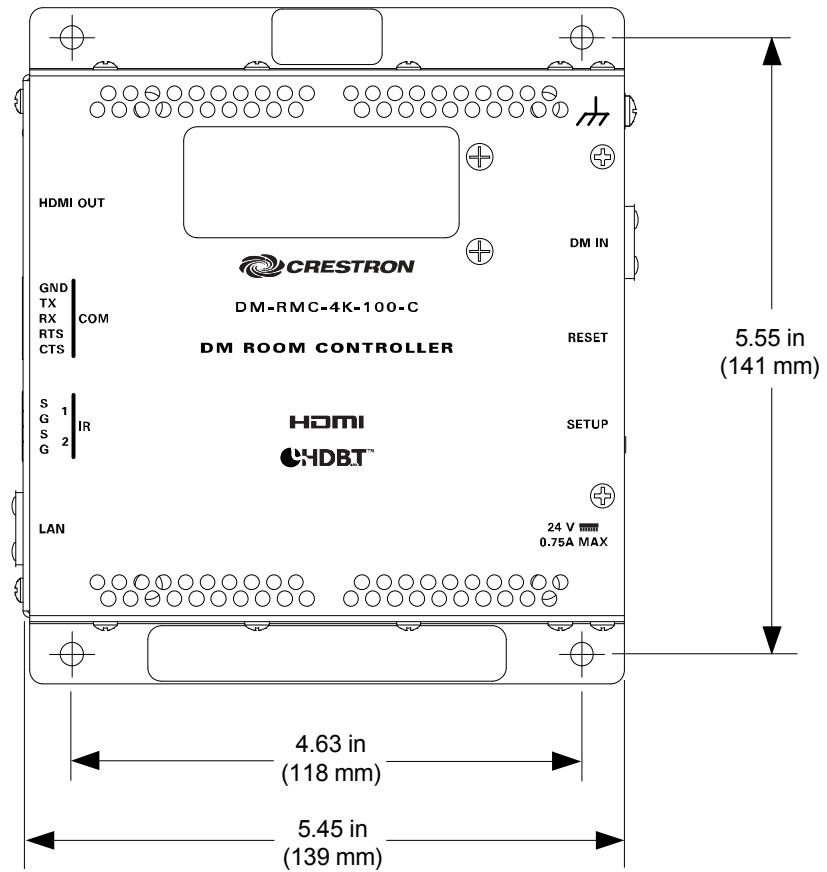

*DM-RMC-4K-100-C Overall Dimensions (Top View)*

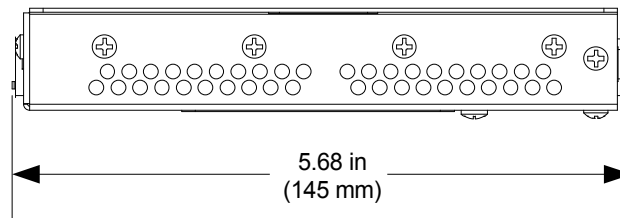

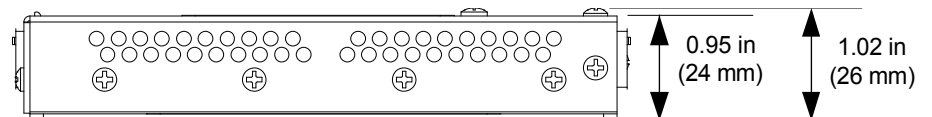

*DM-RMC-4K-100-C Overall Dimensions (Bottom View)*

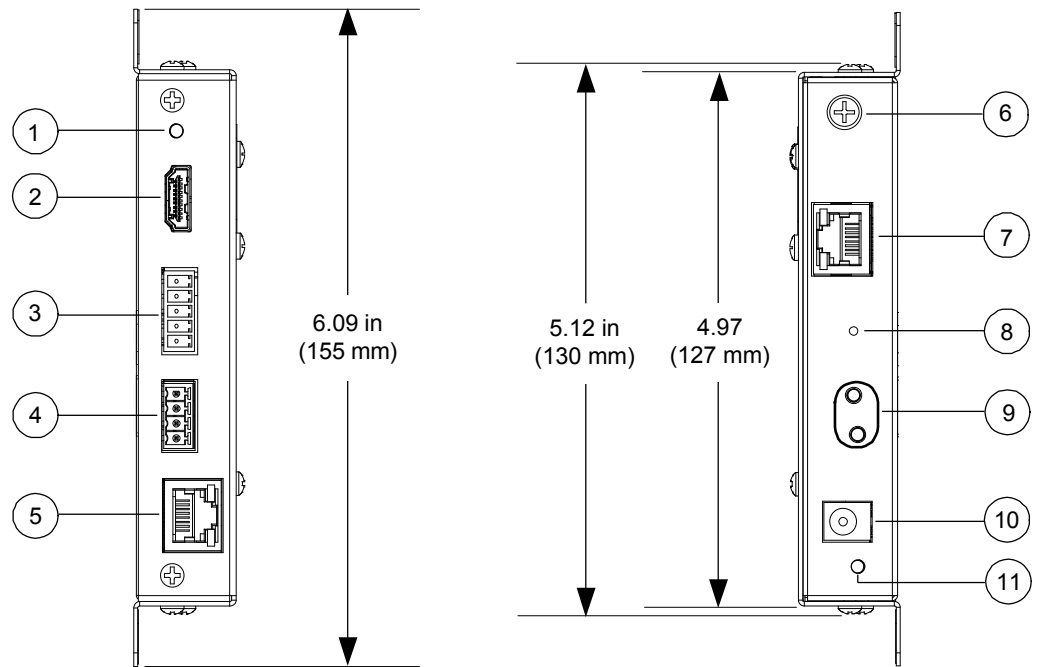

*DM-RMC-4K-100-C Overall Dimensions (Left and Right Side Views)*



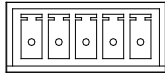



*Connectors, Controls, and Indicators*

#	CONNECTORS, <sup>1</sup> CONTROLS, AND INDICATORS	DESCRIPTION
1	HDMI OUT LED	(1) Green LED, indicates video signal presence at the HDMI output
2	HDMI OUT 	(1) 19-pin Type A HDMI female; HDMI digital video and audio output; Supports DVI <sup>2</sup>
3	COM 	(1) 5-pin 3.5 mm detachable terminal block, bidirectional RS-232 port; Up to 115.2 kBd, hardware and software handshaking support
4	IR (1-2) 	(1) 4-pin 3.5 mm detachable terminal block comprising two IR/serial ports; IR output up to 1.1 MHz; 1-way serial TTL/RS-232 (0-5 volts) up to 19200 baud <sup>3</sup>

*(Continued on following page)*

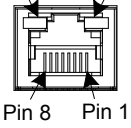

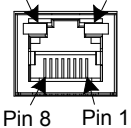
*Connectors, Controls, and Indicators*

#	CONNECTORS, <sup>1</sup> CONTROLS, AND INDICATORS	DESCRIPTION																				
5	<p>LAN Green LED    Amber LED</p> 	<p>(1) 8-pin RJ-45 female, shielded, with two LED indicators; 10BASE-T/100BASE-TX Ethernet port; Green LED indicates Ethernet link status; Amber LED indicates Ethernet activity</p> <table border="1"> <thead> <tr> <th>PIN</th> <th>SIGNAL</th> <th>PIN</th> <th>SIGNAL</th> </tr> </thead> <tbody> <tr> <td>1</td> <td>TX +</td> <td>5</td> <td>N/C</td> </tr> <tr> <td>2</td> <td>TX -</td> <td>6</td> <td>RX -</td> </tr> <tr> <td>3</td> <td>RX +</td> <td>7</td> <td>N/C</td> </tr> <tr> <td>4</td> <td>N/C</td> <td>8</td> <td>N/C</td> </tr> </tbody> </table>	PIN	SIGNAL	PIN	SIGNAL	1	TX +	5	N/C	2	TX -	6	RX -	3	RX +	7	N/C	4	N/C	8	N/C
PIN	SIGNAL	PIN	SIGNAL																			
1	TX +	5	N/C																			
2	TX -	6	RX -																			
3	RX +	7	N/C																			
4	N/C	8	N/C																			
6		(1) 6-32 screw, chassis ground lug																				
7	<p>DM IN<sup>4</sup> Green LED    Amber LED</p> 	<p>(1) 8-pin RJ-45 female, shielded, with two LED indicators; DM 8G+ input, HDBaseT compliant; PoDM and PoH PD (Powered Device) port;<sup>5</sup> Connects to the DM 8G+ output of a DM switcher, transmitter, or other DM device, or to an HDBaseT device via CAT5e or Crestron DM-CBL-8G cable;<sup>6</sup> Green LED indicates DM link status; Solid amber LED indicates HDCP video; Blinking amber LED indicates non-HDCP video</p>																				
8	RESET	(1) Miniature recessed push button for hardware reset																				
9	SETUP (Button and LED)	(1) Miniature recessed push button for Ethernet setup and (1) red LED																				
10	<p>24 V 0.75A MAX</p> 	(1) 2.1 x 5.5 mm dc power connector; 24 Vdc power input; Power pack included																				
11	Power LED	(1) Green LED, indicates operating power supplied from local power pack, PoDM, or PoH																				

1. Interface connectors for the COM and IR ports are provided with the unit.
2. The HDMI output requires an appropriate adapter or interface cable to accommodate a DVI signal. CBL-HD-DVI interface cables are sold separately.
3. Maximum string length for serial commands sent via the IR port should be no greater than 40 characters.

4. The DM IN port consists of one RJ-45 connector. Refer to the following table for the connector pinouts.

**DM IN Connector Pinouts**

			
PIN #	WIRE COLOR	PIN #	WIRE COLOR
1	Orange/White	5	Blue/White
2	Orange	6	Green
3	Green/White	7	Brown/White
4	Blue	8	Brown

5. Receiving Power over DM (PoDM) or Power over HDBaseT (PoH) requires connection to a switcher or other equipment that has a PoDM or PoH PSE (Power Sourcing Equipment) port. Any wiring that is connected to a PoDM or PoH PSE port is for intra-building use only and should not be connected to a line that runs outside of the building in which the PSE is located.
6. The maximum cable length for DigitalMedia 8G+ (DM 8G+) or HDBaseT is 330 feet (100 meters) for resolutions up to 1600 x 1200 and 1920 x 1200 (including 1080p60 and 2K) using DM-CBL-8G DigitalMedia 8G cable, DM-CBL DigitalMedia cable, DM-CBL-D DigitalMedia D cable, or third-party CAT5e (or better) UTP or STP. For higher resolutions (including 4K), the maximum wire length is 230 feet (70 meters) using DM-CBL-8G or 165 feet (50 meters) using DM-CBL, DM-CBL-D, or CAT5e. Shielded cable and connectors are recommended to safeguard against unpredictable environmental electrical noise, which may impact performance at resolutions above 1080p. For complete system design guidelines, refer to the DigitalMedia Design Guide (Doc. 4546). DM 8G+ is compatible with HDBaseT Alliance specifications for connecting to HDBaseT compliant equipment. All wire and cables are sold separately.

## Setup

### Network Wiring

When wiring the DM network, consider the following:

- Use Crestron Certified Wire.
- Use Crestron power supplies for Crestron equipment.

---

**CAUTION:** Failure to use Crestron power supplies could cause equipment damage or void the Crestron warranty.

---

- Provide sufficient power to the system.
- The maximum cable length for DigitalMedia 8G+ (DM 8G+) or HDBaseT is 330 feet (100 meters) for resolutions up to 1600 x 1200 and 1920 x 1200 (including 1080p60 and 2K) using DM-CBL-8G DigitalMedia 8G™ cable, DM-CBL DigitalMedia cable, DM-CBL-D DigitalMedia D cable, or third-party CAT5e (or better) UTP or STP. For higher resolutions (including 4K), the maximum wire length is 230 feet (70 meters) using DM-CBL-8G or 165 feet (50 meters) using DM-CBL, DM-CBL-D, or CAT5e. Shielded cable and connectors are recommended to safeguard against unpredictable environmental electrical noise, which may impact performance at resolutions above 1080p. For complete system design guidelines, refer to the DigitalMedia Design Guide (Doc. 4546) at [www.crestron.com/manuals](http://www.crestron.com/manuals). DM 8G+ is compatible with HDBaseT Alliance specifications for connecting to HDBaseT compliant equipment.

#### *Maximum Cable Length*

RESOLUTION	CABLE TYPE	
	DM-CBL-8G	CAT5E (OR BETTER) UTP OR STP
1080p60 Full HD 1920 x 1200 WUXGA 1600 x 1200 UXGA 2048 x 1080 2K DCI	330 feet (100 meters)	330 feet (100 meters)
2560 x 1440 WQHD 2560 x 1600 WQXGA 3840 x 2160 4K Ultra HD 4096 x 2160 4K DCI	230 feet (70 meters)	165 feet (50 meters)

The DM-RMC-4K-100-C also uses high-speed Ethernet for communications between the device and a control system, computer, media server, and other IP-based devices. For general information on connecting Ethernet devices in a Crestron system, refer to the Crestron e-Control® Reference Guide (Doc. 6052) at [www.crestron.com/manuals](http://www.crestron.com/manuals). For information specifically related to Ethernet connectivity using DigitalMedia devices, refer to the Crestron IP Considerations Guide for the IT Professional (Doc. 4579) at [www.crestron.com/manuals](http://www.crestron.com/manuals).

## Identity Code

---

**NOTE:** The latest software can be downloaded at [www.crestron.com/software](http://www.crestron.com/software).

---

The IP ID is set within the DM-RMC-4K-100-C IP table using Crestron Toolbox™. For information on setting an IP table, refer to the Crestron Toolbox help file. The IP IDs of multiple DM-RMC-4K-100-C devices in the same system must be unique.

When setting the IP ID, consider the following:

- The IP ID of each unit must match an IP ID specified in the Crestron Studio™ or SIMPL Windows program.
- Each device using IP to communicate with a control system must have a unique IP ID.

## Installation

The DM-RMC-4K-100-C mounts on a flat surface such as a wall or ceiling. The DM-RMC-4K-100-C can also be mounted on a rack rail.

### *Ventilation*

The DM-RMC-4K-100-C should be used in a well-ventilated area. The venting holes should not be obstructed under any circumstances.

To prevent overheating, do not operate this product in an area that exceeds the environmental temperature range listed in the table of specifications.

### *Mounting on a Flat Surface*

To mount the DM-RMC-4K-100-C on a flat surface such as a wall or ceiling, use four mounting screws (not included). The following illustration shows mounting of the DM-RMC-4K-100-C on a wall.

---

**NOTE:** To ensure optimum ventilation when mounted on a wall, position the DM-RMC-4K-100-C vertically so that the venting holes are positioned at the top and bottom of the unit.

---

*Mounting DM-RMC-4K-100-C on a Wall*

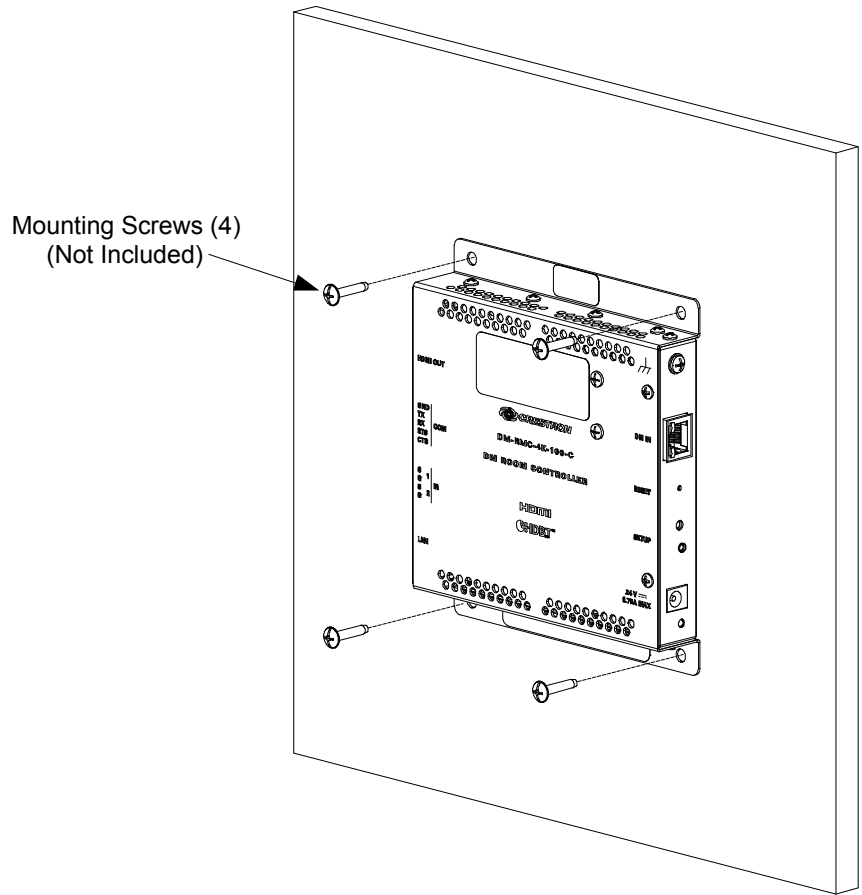

**Rack Mounting**

To mount the DM-RMC-4K-100-C on the left or right rail of a rack, use two rack mounting screws (not included). The following illustration shows mounting of the DM-RMC-4K-100-C on the right rail of a rack.

*Mounting DM-RMC-4K-100-C on Rack Rail (Right Rack Rail Shown)*

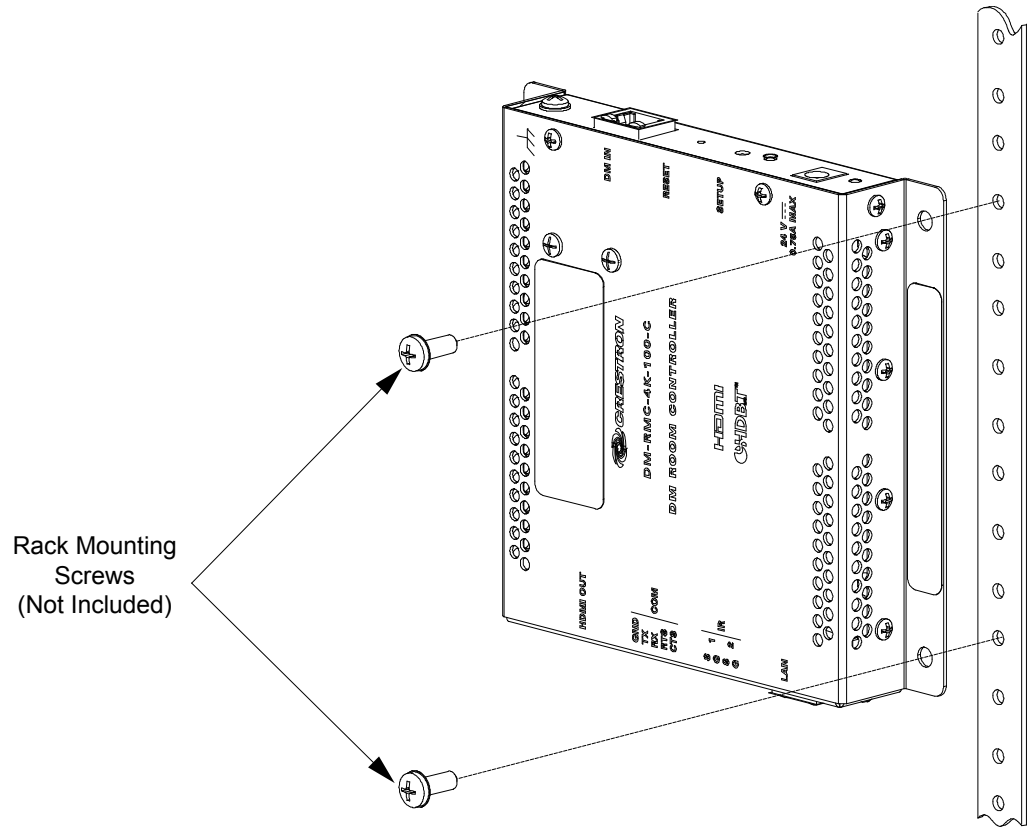

**Hardware Hookup**

Make the necessary connections as called out in the following illustrations. Refer to “Network Wiring” on page 13. Apply power after all connections have been made.

*Hardware Connections for the DM-RMC-4K-100-C (Left Side)*

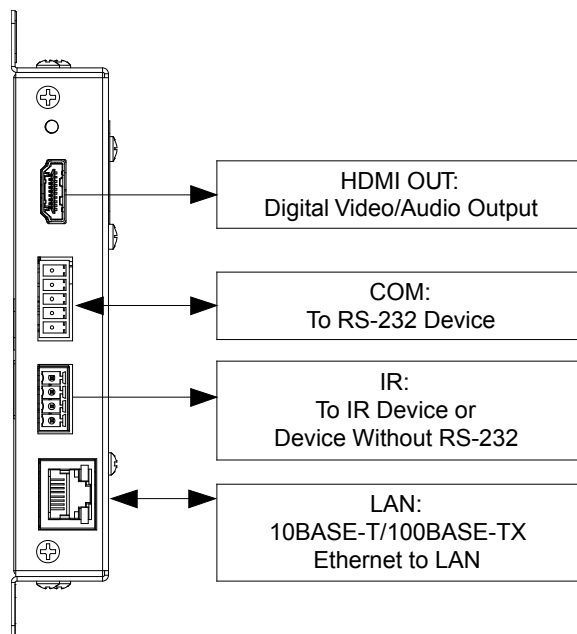

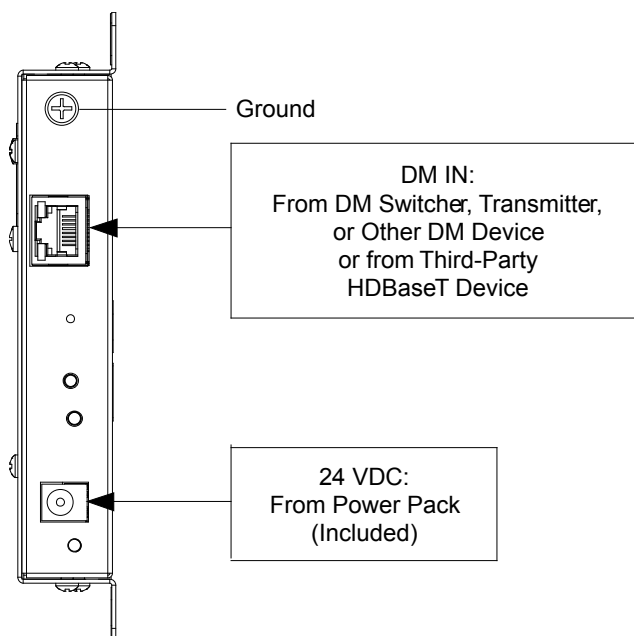
*Hardware Connections for the DM-RMC-4K-100-C (Right Side)*

---

**NOTE:** Ensure that the unit is properly grounded by connecting the chassis ground lug to an earth ground (building steel).

**NOTE:** The maximum cable length for DigitalMedia 8G+ (DM 8G+) or HDBaseT is 330 feet (100 meters) for resolutions up to 1600 x 1200 and 1920 x 1200 (including 1080p60 and 2K) using DM-CBL-8G DigitalMedia 8G cable, DM-CBL DigitalMedia cable, DM-CBL-D DigitalMedia D cable, or third-party CAT5e (or better) UTP or STP. For higher resolutions (including 4K), the maximum wire length is 230 feet (70 meters) using DM-CBL-8G or 165 feet (50 meters) using DM-CBL, DM-CBL-D, or CAT5e. Shielded cable and connectors are recommended to safeguard against unpredictable environmental electrical noise, which may impact performance at resolutions above 1080p. Refer to the DigitalMedia Design Guide (Doc. 4546) for complete system design guidelines. DM 8G+ is compatible with HDBaseT Alliance specifications for connecting to HDBaseT compliant equipment.

**NOTE:** The 24 Vdc power pack (included) is not required if Power over DM or Power over HDBaseT is used.

---

## Uploading and Upgrading

Crestron recommends using the latest programming software and that each device contains the latest firmware to take advantage of the most recently released features. However, before attempting to upload or upgrade it is necessary to establish communication. Once communication has been established, files (for example, firmware) can be transferred to the device. In addition, the IP table of the device can be configured.

**NOTE:** Crestron software and any files on the website are for authorized Crestron dealers and Crestron Service Providers (CSPs) only. New users must register to obtain access to certain areas of the site (including the FTP site).

### Establishing Communication

Use Crestron Toolbox for communicating with the DM-RMC-4K-100-C; refer to the Crestron Toolbox help file for details.

A PC running Crestron Toolbox communicates with the DM-RMC-4K-100-C in the following ways:

- Via a DM switcher using TCP/IP communication.
- Via the LAN port of the DM-RMC-4K-100-C using TCP/IP communication. This scenario is applicable only to a standalone configuration (a DM switcher is not used).

#### Via DM Switcher

#### TCP/IP Communication via DM Switcher

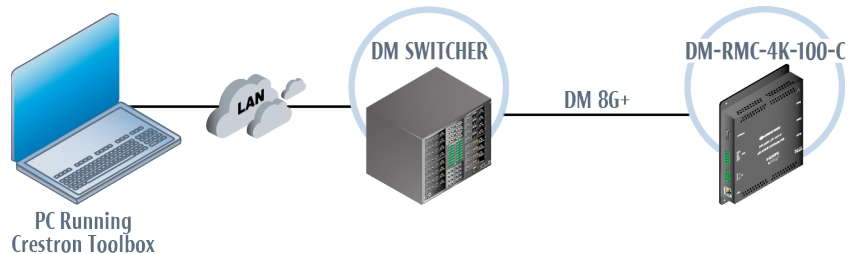

To establish TCP/IP communication between the PC and the DM-RMC-4K-100-C via a DM switcher, communication between the PC and the DM switcher must be established as described in the DigitalMedia Switchers Operations Guide (Doc. 6755). The DM switcher then manages IP setup and firmware update of the DM-RMC-4K-100-C.

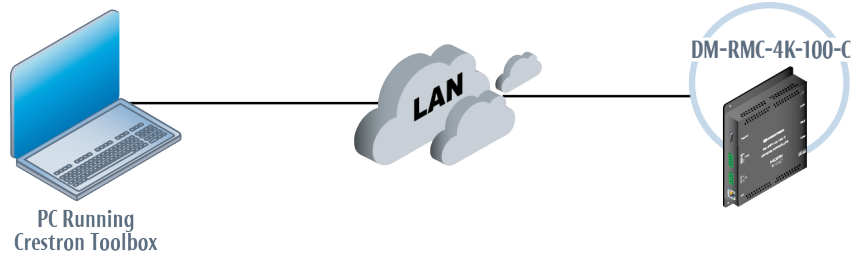

**Via LAN Port****TCP/IP Communication via LAN Port of DM-RMC-4K-100-C**

To establish TCP/IP communication between the PC and the DM-RMC-4K-100-C via the LAN port of the DM-RMC-4K-100-C, do the following:

1. Use the Device Discovery Tool in Crestron Toolbox to find the IP address of the DM-RMC-4K-100-C. The tool is available in Toolbox version 1.15.143 or later.

---

**NOTE:** When the DM-RMC-4K-100-C is used in a standalone configuration (not used with a DM switcher), DHCP is enabled by default. If desired, a default IP address (192.168.1.243) can be assigned by holding down its **SETUP** button while applying power. This IP address overwrites any previous settings and remains until it is changed.

---

2. Use the Address Book in Crestron Toolbox to create an entry for the DM-RMC-4K-100-C using the TCP connection type, and enter the IP address of the DM-RMC-4K-100-C.
3. Display the DM-RMC-4K-100-C's **System Info** window (**Tools | System Info**); communications are confirmed when the device information is displayed.
4. (Optional) If additional changes to TCP/IP settings are desired, do the following:
  - a. Assign an IP address, IP mask, and default router for the DM-RMC-4K-100-C via the Crestron Toolbox (**Functions | Ethernet Addressing**).
  - b. Close the **System Info** window.
  - c. In Crestron Toolbox, change the Address Book entry for the DM-RMC-4K-100-C so that it uses the IP address assigned in step 4a.
  - d. Display the DM-RMC-4K-100-C's **System Info** window (**Tools | System Info**); communications are confirmed when the device information is displayed.

## Firmware

Check the Crestron website to find the latest firmware. (New users may be required to register to obtain access to certain areas of the site, including the FTP site.)

To upgrade DM-RMC-4K-100-C firmware, do the following:

1. Using the Device Discovery Tool in Crestron Toolbox, find the IP address of the DM switcher (if the DM-RMC-4K-100-C is connected to a DM switcher) or the IP address of the DM-RMC-4K-100-C (if the DM-RMC-4K-100-C is being used in a standalone configuration).
2. Add the IP address found in step 1 to the Address Book in Toolbox.

3. Download the appropriate .puf file from the Crestron website to the PC.
4. Double-click the .puf file. The Package Update Tool opens and displays the Address Book.
5. From the list in the Address Book, select the DM switcher (if the DM-RMC-4K-100-C is connected to a switcher) or the DM-RMC-4K-100-C (if the DM-RMC-4K-100-C is used in a standalone configuration), and then click **OK**.

Either of the following occurs:

- If the DM switcher was selected, a DM device list is displayed that allows upgrading all DM devices connected to the switcher.
- If the DM-RMC-4K-100-C was selected, a DM device list is displayed that allows upgrading of the DM-RMC-4K-100-C only.

In the DM device lists that are displayed, the checkbox of any item that needs to be upgraded is automatically selected.

6. Click **Update**.
7. After the process is complete, click **Recheck** to verify the upgrade.

## IP Table Configuration

If the DM-RMC-4K-100-C is used in a standalone configuration (without a DM switcher), use Crestron Toolbox to create the IP table entry of the DM-RMC-4K-100-C.

---

**NOTE:** If the DM-RMC-4K-100-C is connected to a DM switcher, the IP table entry of the DM-RMC-4K-100-C is created automatically.

---

1. Use the Device Discovery Tool in Crestron Toolbox to find the IP address of the DM-RMC-4K-100-C.
2. Display the **System Info** window (**Tools | System Info**) and select the DM-RMC-4K-100-C entry from the Address Book.
3. Select **Functions | IP Table Setup**.
4. Add, modify, or delete entries in the IP table. The DM-RMC-4K-100-C can have only one IP table entry.
5. A defined IP table can be saved to a file or sent to the device.

## Problem Solving

### Troubleshooting

The following table provides corrective action for possible trouble situations. If further assistance is required, please contact a Crestron customer service representative.

#### *DM-RMC-4K-100-C Troubleshooting*

<b>TROUBLE</b>	<b>POSSIBLE CAUSE(S)</b>	<b>CORRECTIVE ACTION</b>
Power LED does not illuminate.	Device is not receiving power.	<p>If device is powered over DM, do the following:</p> <ul style="list-style-type: none"> <li>• Verify cable connection to the DM IN port.</li> <li>• Verify that device connected to the DM IN port can provide power to this device.</li> </ul> <p>If device is powered from power pack connected to dc power jack, verify power pack connections to the device and to the power outlet.</p>
Green LED on DM IN port does not illuminate.	Device cannot establish a link to the device connected to the DM IN port.	Verify cable connection to the DM IN port.
HDMI OUT LED does not illuminate.	Device is not receiving video signal.	Ensure proper video signal is routed to device.
	Device connected to the HDMI OUT port has not sent the hotplug signal.	Power on device connected to the HDMI OUT port and ensure that it is switched to the correct input.
HDMI OUT LED is green but video on connected display is black.	HDCP is blanking the video output.	Verify that device connected to HDMI output supports HDCP.

*(Continued on following page)*

*DM-RMC-4K-100-C Troubleshooting (Continued)*

<b>TROUBLE</b>	<b>POSSIBLE CAUSE(S)</b>	<b>CORRECTIVE ACTION</b>
LAN LED does not illuminate green.	LAN network cable is not connected to the LAN port or to the 10BASE-T/100BASE-TX compatible device.	Verify LAN network cable connection to the LAN port and to the compatible network device.
	LAN network cable is not the proper type.	Verify that network cable complies with EIA/TIA 568 and the CAT5 specification.
	LAN network cable is not the proper length.	Verify that network cable is the proper length.
	10BASE-T/100BASE-TX compatible device is not receiving power.	Apply power to the network device.
Device loses functionality due to electrostatic discharge.	Device is improperly grounded.	Check that all ground connections have been made properly.

**NOTE:** For more advanced diagnostics, use the DMTool in Crestron Toolbox.

## Reference Documents

All documents mentioned in this guide are available at [www.crestron.com/manuals](http://www.crestron.com/manuals).

### *List of Related Reference Documents*

<b>DOCUMENT TITLE</b>
DigitalMedia Design Guide
Crestron DigitalMedia Switchers Operations Guide
Crestron e-Control Reference Guide
Crestron IP Considerations Guide for the IT Professional

## Further Inquiries

To locate specific information or resolve questions after reviewing this guide, contact Crestron's True Blue Support at 1-888-CRESTRON [1-888-273-7876] or, for assistance within a particular geographic region, refer to the listing of Crestron worldwide offices at [www.crestron.com/offices](http://www.crestron.com/offices).

To post a question about Crestron products, log onto Crestron's Online Help at [www.crestron.com/onlinehelp](http://www.crestron.com/onlinehelp). First-time users must establish a user account to fully benefit from all available features.

## **Future Updates**

As Crestron improves functions, adds new features, and extends the capabilities of the DM-RMC-4K-100-C, additional information may be made available as manual updates. These updates are solely electronic and serve as intermediary supplements prior to the release of a complete technical documentation revision.

Check the Crestron website periodically for manual update availability and its relevance. Updates are identified as an “Addendum” in the Download column.

---

## Return and Warranty Policies

### Merchandise Returns / Repair Service

1. No merchandise may be returned for credit, exchange or service without prior authorization from Crestron. To obtain warranty service for Crestron products, contact an authorized Crestron dealer. Only authorized Crestron dealers may contact the factory and request an RMA (Return Merchandise Authorization) number. Enclose a note specifying the nature of the problem, name and phone number of contact person, RMA number and return address.
2. Products may be returned for credit, exchange or service with a Crestron Return Merchandise Authorization (RMA) number. Authorized returns must be shipped freight prepaid to Crestron, 6 Volvo Drive, Rockleigh, N.J. or its authorized subsidiaries, with RMA number clearly marked on the outside of all cartons. Shipments arriving freight collect or without an RMA number shall be subject to refusal. Crestron reserves the right in its sole and absolute discretion to charge a 15% restocking fee plus shipping costs on any products returned with an RMA.
3. Return freight charges following repair of items under warranty shall be paid by Crestron, shipping by standard ground carrier. In the event repairs are found to be non-warranty, return freight costs shall be paid by the purchaser.

### Crestron Limited Warranty

Crestron Electronic, Inc. warrants its products to be free from manufacturing defects in materials and workmanship under normal use for a period of three (3) years from the date of purchase from Crestron, with the following exceptions: disk drives and any other moving or rotating mechanical parts, pan/tilt heads and power supplies are covered for a period of one (1) year; touch screen display and overlay components are covered for 90 days; batteries and incandescent lamps are not covered.

This warranty extends to products purchased directly from Crestron or an authorized Crestron dealer. Purchasers should inquire of the dealer regarding the nature and extent of the dealer's warranty, if any.

Crestron shall not be liable to honor the terms of this warranty if the product has been used in any application other than that for which it was intended or if it has been subjected to misuse, accidental damage, modification or improper installation procedures. Furthermore, this warranty does not cover any product that has had the serial number altered, defaced or removed.

This warranty shall be the sole and exclusive remedy to the original purchaser. In no event shall Crestron be liable for incidental or consequential damages of any kind (property or economic damages inclusive) arising from the sale or use of this equipment. Crestron is not liable for any claim made by a third party or made by the purchaser for a third party.

Crestron shall, at its option, repair or replace any product found defective, without charge for parts or labor. Repaired or replaced equipment and parts supplied under this warranty shall be covered only by the unexpired portion of the warranty.

Except as expressly set forth in this warranty, Crestron makes no other warranties, expressed or implied, nor authorizes any other party to offer any warranty, including any implied warranties of merchantability or fitness for a particular purpose. Any implied warranties that may be imposed by law are limited to the terms of this limited warranty. This warranty statement supersedes all previous warranties.

---

# GNU General Public License

Version 2, June 1991

Copyright (C) 1989, 1991 Free Software Foundation, Inc., 51 Franklin Street, Fifth Floor, Boston, MA 02110-1301 USA  
Everyone is permitted to copy and distribute verbatim copies of this license document but changing it is not allowed.

## PREAMBLE

The licenses for most software are designed to take away your freedom to share and change it. By contrast, the GNU General Public License is intended to guarantee your freedom to share and change free software--to make sure the software is free for all its users. This General Public License applies to most of the Free Software Foundation's software and to any other program whose authors commit to using it. (Some other Free Software Foundation software is covered by the GNU Lesser General Public License instead.) You can apply it to your programs too.

When we speak of free software, we are referring to freedom, not price. Our General Public Licenses are designed to make sure that you have the freedom to distribute copies of free software (and charge for this service if you wish), that you receive source code or can get it if you want it, that you can change the software or use pieces of it in new free programs and that you know you can do these things.

To protect your rights, we need to make restrictions that forbid anyone to deny you these rights or to ask you to surrender the rights. These restrictions translate to certain responsibilities for you if you distribute copies of the software or if you modify it.

For example, if you distribute copies of such a program, whether gratis or for a fee, you must give the recipients all the rights that you have. You must make sure that they too receive or can get the source code. And you must show them these terms so they know their rights.

We protect your rights with two steps: (1) copyright the software, and (2) offer you this license which gives you legal permission to copy, distribute and/or modify the software.

Also, for each author's protection and ours, we want to make certain that everyone understands that there is no warranty for this free software. If the software is modified by someone else and passed on, we want its recipients to know that what they have is not the original, so that any problems introduced by others will not reflect on the original authors' reputations.

Finally, any free program is threatened constantly by software patents. We wish to avoid the danger that redistributors of a free program will individually obtain patent licenses, in effect making the program proprietary. To prevent this, we have made it clear that any patent must be licensed for everyone's free use or not licensed at all.

The precise terms and conditions for copying, distribution and modification follow.

## GNU GENERAL PUBLIC LICENSE TERMS AND CONDITIONS FOR COPYING, DISTRIBUTION AND MODIFICATION

0. This License applies to any program or other work which contains a notice placed by the copyright holder saying it may be distributed under the terms of this General Public License. The "Program" below refers to any such program or work, and a "work based on the Program" means either the Program or any derivative work under copyright law: that is to say, a work containing the Program or a portion of it, either verbatim or with modifications and/or translated into another language. (Hereinafter, translation is included without limitation in the term "modification".) Each licensee is addressed as "you".

Activities other than copying, distribution and modification are not covered by this License; they are outside its scope. The act of running the Program is not restricted, and the output from the Program is covered only if its contents constitute a work based on the Program (independent of having been made by running the Program). Whether that is true depends on what the Program does.

1. You may copy and distribute verbatim copies of the Program's source code as you receive it, in any medium, provided that you conspicuously and appropriately publish on each copy an appropriate copyright notice and disclaimer of warranty; keep intact all the notices that refer to this License and to the absence of any warranty; and give any other recipients of the Program a copy of this License along with the Program.

You may charge a fee for the physical act of transferring a copy and you may at your option offer warranty protection in exchange for a fee.

2. You may modify your copy or copies of the Program or any portion of it, thus forming a work based on the Program, and copy and distribute such modifications or work under the terms of Section 1 above, provided that you also meet all of these conditions:

- a) You must cause the modified files to carry prominent notices stating that you changed the files and the date of any change.
- b) You must cause any work that you distribute or publish, that in whole or in part contains or is derived from the Program or any part thereof, to be licensed as a whole at no charge to all third parties under the terms of this License.
- c) If the modified program normally reads commands interactively when run, you must cause it, when started running for such interactive use in the most ordinary way, to print or display an announcement including an appropriate copyright notice and a notice that there is no warranty (or else, saying that you provide a warranty) and that users may redistribute the program under these conditions, and telling the user how to view a copy of this License. (Exception: if the Program itself is interactive but does not normally print such an announcement, your work based on the Program is not required to print an announcement.)

These requirements apply to the modified work as a whole. If identifiable sections of that work are not derived from the Program and can be reasonably considered independent and separate works in themselves, then this License and its terms do not apply to those sections when you distribute them as separate works. But when you distribute the same sections as part of a whole which is a work based on the Program, the distribution of the whole must be on the terms of this License, whose permissions for other licensees extend to the entire whole and thus to each and every part regardless of who wrote it.

Thus, it is not the intent of this section to claim rights or contest your rights to work written entirely by you; rather, the intent is to exercise the right to control the distribution of derivative or collective works based on the Program.

In addition, mere aggregation of another work not based on the Program with the Program (or with a work based on the Program) on a volume of a storage or distribution medium does not bring the other work under the scope of this License.

3. You may copy and distribute the Program (or a work based on it, under Section 2) in object code or executable form under the terms of Sections 1 and 2 above provided that you also do one of the following:

- a) Accompany it with the complete corresponding machine-readable source code, which must be distributed under the terms of Sections 1 and 2 above on a medium customarily used for software interchange; or,
- b) Accompany it with a written offer, valid for at least three years, to give any third party, for a charge no more than your cost of physically performing source distribution, a complete machine-readable copy of the corresponding source code, to be distributed under the terms of Sections 1 and 2 above on a medium customarily used for software interchange; or,
- c) Accompany it with the information you received as to the offer to distribute corresponding source code. (This alternative is allowed only for noncommercial distribution and only if you received the program in object code or executable form with such an offer, in accord with Subsection b above.)

The source code for a work means the preferred form of the work for making modifications to it. For an executable work, complete source code means all the source code for all modules it contains, plus any associated interface definition files, plus the scripts used to control compilation and installation of the executable. However, as a special exception, the source code distributed need not include anything that is normally distributed (in either source or binary form) with the major components (compiler, kernel and so on) of the operating system on which the executable runs, unless that component itself accompanies the executable.

If distribution of executable or object code is made by offering access to copy from a designated place, then offering equivalent access to copy the source code from the same place counts as distribution of the source code, even though third parties are not compelled to copy the source along with the object code.

4. You may not copy, modify, sublicense or distribute the Program except as expressly provided under this License. Any attempt otherwise to copy, modify, sublicense or distribute the Program is void and will automatically terminate your rights under this License. However, parties who have received copies or rights, from you under this License will not have their licenses terminated so long as such parties remain in full compliance.

5. You are not required to accept this License, since you have not signed it. However, nothing else grants you permission to modify or distribute the Program or its derivative works. These actions are prohibited by law if you do not accept this License. Therefore, by



modifying or distributing the Program (or any work based on the Program), you indicate your acceptance of this License to do so and all its terms and conditions for copying, distributing or modifying the Program or works based on it.

6. Each time you redistribute the Program (or any work based on the Program), the recipient automatically receives a license from the original licensor to copy, distribute or modify the Program subject to these terms and conditions. You may not impose any further restrictions on the recipients' exercise of the rights granted herein. You are not responsible for enforcing compliance by third parties to this License.

7. If, as a consequence of a court judgment or allegation of patent infringement or for any other reason (not limited to patent issues), conditions are imposed on you (whether by court order, agreement or otherwise) that contradict the conditions of this License, they do not excuse you from the conditions of this License. If you cannot distribute so as to satisfy simultaneously your obligations under this License and any other pertinent obligations, then as a consequence you may not distribute the Program at all. For example, if a patent license would not permit royalty-free redistribution of the Program by all those who receive copies directly or indirectly through you, then the only way you could satisfy both it and this License would be to refrain entirely from distribution of the Program.

If any portion of this section is held invalid or unenforceable under any particular circumstance, the balance of the section is intended to apply and the section as a whole is intended to apply in other circumstances.

It is not the purpose of this section to induce you to infringe any patents or other property right claims or to contest validity of any such claims; this section has the sole purpose of protecting the integrity of the free software distribution system, which is implemented by public license practices. Many people have made generous contributions to the wide range of software distributed through that system in reliance on consistent application of that system; it is up to the author/donor to decide if he or she is willing to distribute software through any other system and a licensee cannot impose that choice.

This section is intended to make thoroughly clear what is believed to be a consequence of the rest of this License.

8. If the distribution and/or use of the Program is restricted in certain countries either by patents or by copyrighted interfaces, the original copyright holder who places the Program under this License may add an explicit geographical distribution limitation excluding those countries, so that distribution is permitted only in or among countries not thus excluded. In such case, this License incorporates the limitation as if written in the body of this License.

9. The Free Software Foundation may publish revised and/or new versions of the General Public License from time to time. Such new versions will be similar in spirit to the present version but may differ in detail to address new problems or concerns.

Each version is given a distinguishing version number. If the Program specifies a version number of this License which applies to it and "any later version", you have the option of following the terms and conditions either of that version or of any later version published by the Free Software Foundation. If the Program does not specify a version number of this License, you may choose any version ever published by the Free Software Foundation.

10. If you wish to incorporate parts of the Program into other free programs whose distribution conditions are different, write to the author to ask for permission. For software which is copyrighted by the Free Software Foundation, write to the Free Software Foundation; we sometimes make exceptions for this. Our decision will be guided by the two goals of preserving the free status of all derivatives of our free software and of promoting the sharing and reuse of software generally.

#### NO WARRANTY

11. BECAUSE THE PROGRAM IS LICENSED FREE OF CHARGE, THERE IS NO WARRANTY FOR THE PROGRAM, TO THE EXTENT PERMITTED BY APPLICABLE LAW. EXCEPT WHEN OTHERWISE STATED IN WRITING THE COPYRIGHT HOLDERS AND/OR OTHER PARTIES PROVIDE THE PROGRAM "AS IS" WITHOUT WARRANTY OF ANY KIND, EITHER EXPRESSED OR IMPLIED, INCLUDING BUT NOT LIMITED TO, THE IMPLIED WARRANTIES OF MERCHANTABILITY AND FITNESS FOR A PARTICULAR PURPOSE. THE ENTIRE RISK AS TO THE QUALITY AND PERFORMANCE OF THE PROGRAM IS WITH YOU. SHOULD THE PROGRAM PROVE DEFECTIVE, YOU ASSUME THE COST OF ALL NECESSARY SERVICING, REPAIR OR CORRECTION.

12. IN NO EVENT UNLESS REQUIRED BY APPLICABLE LAW OR AGREED TO IN WRITING WILL ANY COPYRIGHT HOLDER OR ANY OTHER PARTY WHO MAY MODIFY AND/OR REDISTRIBUTE THE PROGRAM AS PERMITTED ABOVE, BE LIABLE TO YOU FOR DAMAGES, INCLUDING ANY GENERAL, SPECIAL, INCIDENTAL OR CONSEQUENTIAL DAMAGES ARISING OUT OF THE USE OR INABILITY TO USE THE PROGRAM (INCLUDING BUT NOT LIMITED TO LOSS OF DATA OR DATA BEING RENDERED INACCURATE OR LOSSES SUSTAINED BY YOU OR THIRD PARTIES OR A FAILURE OF THE PROGRAM TO OPERATE WITH ANY OTHER PROGRAMS), EVEN IF SUCH HOLDER OR OTHER PARTY HAS BEEN ADVISED OF THE POSSIBILITY OF SUCH DAMAGES.

This page is intentionally left blank.

This page is intentionally left blank.



Crestron Electronics, Inc.  
15 Volvo Drive Rockleigh, NJ 07647  
Tel: 888.CRESTRON  
Fax: 201.767.7576  
[www.crestron.com](http://www.crestron.com)



Operations & Installation Guide – DOC. 7522C  
(2036505)

07.14

Specifications subject to  
change without notice.