

Crestron **IM-TCCV**

iMedia Table Mount Computer Center
with Video

Operations & Installation Guide



This document was prepared and written by the Technical Documentation department at:



Crestron Electronics, Inc.

15 Volvo Drive

Rockleigh, NJ 07647

1-888-CRESTRON

All brand names, product names and trademarks are the property of their respective owners.

©2006 Crestron Electronics, Inc.

Contents

iMedia Table Mount Computer Center w/Video: IM-TCCV	1
Introduction	1
Features and Functions	1
The iMedia System	1
Specifications	3
Physical Description	4
Industry Compliance	6
Setup	7
Network Wiring	7
Installation	7
Hardware Hookup	11
System Configuration	12
Operation	13
Problem Solving	14
Troubleshooting	14
Reference Documents	15
Further Inquiries	15
Future Updates	15
Return and Warranty Policies	16
Merchandise Returns / Repair Service	16
CRESTRON Limited Warranty	16

iMedia Table Mount Computer Center w/Video: IM-TCCV

Introduction

Features and Functions

- A flexible multimedia interface for portable, lectern-mount or under-table installation
- Streamlined user controls for foolproof operation
- iMedia Transport for fast and easy single-cable installation
- Supports XGA resolution up to 84 feet, UXGA maximum up to 34 feet
- Supports composite video signals
- Complete system setup in minutes using iMedia Wizard Software

The iMedia Transport

The iMedia transport utilizes a single CAT5e* type cable to transmit computer RGB, video, and stereo audio signals to a single projector or plasma display. A typical XGA signal (1024 X 768 pixels at 60Hz) can be transmitted up to 84 feet using iMedia, while higher resolutions up to 1600 x 1200 can be handled over shorter distances. Audio is transmitted digitally at 20-bit, 48 kHz resolution. Control and power signals are also contained on the same wire, eliminating the need for separate control or power cables.

* For iMedia use CresCAT-IM cable, or quality CAT5e/CAT6 cable having a maximum delay skew of 15ns per 100m.

Table Mount Multimedia Interface

The IM-TCCV is an iMedia (IM) transmitter designed to install flush in any flat surface or underneath a tabletop using the mounting brackets provided. Composite video, RGB, and stereo audio inputs on the front of the IM-TCCV provide for connection to the output of a computer or AV source. Installing wiring for the IM-TCCV is extremely simple requiring just a single CresCAT-IM cable. Up to three IM-TCCV, or other IM transmitters, may be installed as part of a complete system to provide multiple input locations within the room.

Foolproof Operation

Every iMedia system is easy and intuitive to use. A simple press of the **VIDEO** or **PC** buttons on the face of the IM-TCCV selects the appropriate input, turns on the projector (or plasma, etc.), lowers the screen or lift, and routes all the signals where they need to go. The front panel volume control affords easy adjustment of the audio level, and the entire system can be turned off at any time by simply holding down either button for five seconds.

For systems having more than one IM transmitter, selecting an input at a given input location overrides the previously selected input at any other location. The audio level for each input location is controlled individually by its respective volume control.

Applications

The IM-TCCV is part of the Crestron® iMedia line of network devices, room control systems and signal routing solutions. The line of iMedia devices includes receivers and transmitters. Consult the Crestron website for a complete and current listing of the iMedia product line.

The IM-TCCV can be placed in a lectern or mounted to a surface using the included brackets.

The IM-TCCV is part of a family of compatible iMedia devices, all capable of working together to put on simple to complex media presentations. As shown in the following diagram, iMedia transmitters provide input points for video and PC sources on an iMedia receiver.

iMedia System Diagram

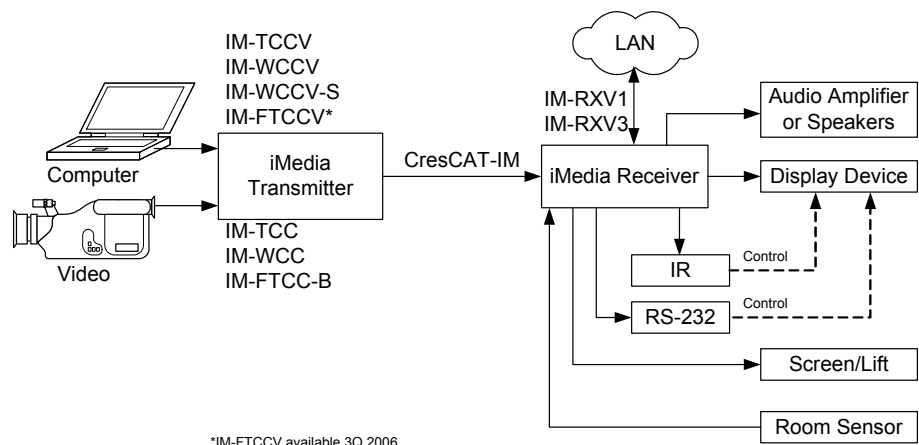

Specifications

Specifications for the IM-TCCV are listed in the following table.

IM-TCCV Specifications

SPECIFICATION	DETAILS
Video Formats	RGBHV (VGA), RGBS, RGsB, composite
RGB Video	
Gain	R/G/B: 0 dB (unity gain, 75 ohm termination)
Max. Input Voltage	R/G/B: 1.0 V _{PP} H/V: 5 V _{PP}
Input Impedance	R/G/B: 75 Ohms H/V: 1k Ohms
Resolutions	Supports video up to XGA @ 60 Hz vertical rate with maximum cable length of 84 feet and maximum compensation at receiver. For higher pixel resolutions (up to 1600 X 1200 pixels at 60 Hz vertical rate) refer to the chart on page 8.
Composite Video	
Gain	Composite: 0 dB (unity gain, 75 ohm termination)
Max. Input Voltage	1.0 V _{PP}
Input Impedance	75 Ohms
Bandwidth	> 100 MHz (-3 dB) at unity gain
Audio	
Max. Input Level	2 V _{RMS}
Input Impedance	10k Ohms
Audio Analog/Digital Conversion	20-bit, 48 kHz
Frequency Response	20 Hz to 20 kHz
Power Requirements	Power is provided by the iMedia receiver via the IM transport
Environmental	
Temperature	41° to 104°F (5° to 40°C)
Humidity	10% to 90% RH (non-condensing)
Enclosure	Compact black metal housing suitable for portable free-standing use, flush-mounted in a flat surface, or surface-mounted below a tabletop using universal brackets provided
Dimensions (without brackets)	
Height	1.50 in (3.81 cm)
Width	7.40 in (18.80 cm)
Depth	3.13 in (7.95 cm)
Weight	14.8 oz (420 grams)

Physical Description

This section provides information on the connections, controls, and indicators available on your IM-TCCV.

IM-TCCV Physical View

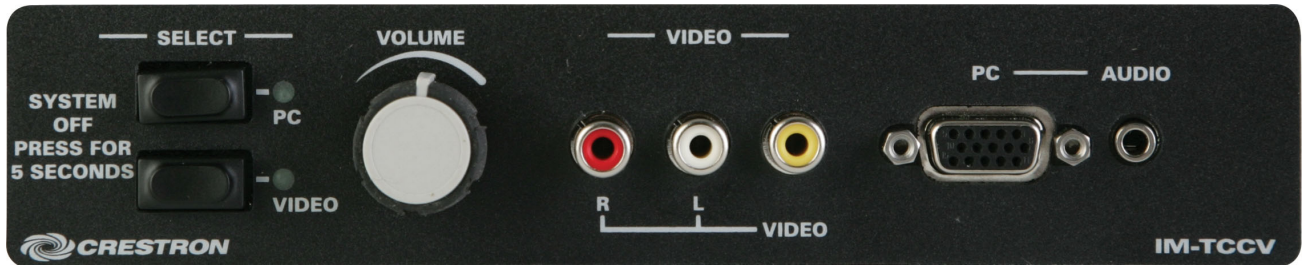

IM-TCCV Overall Dimensions

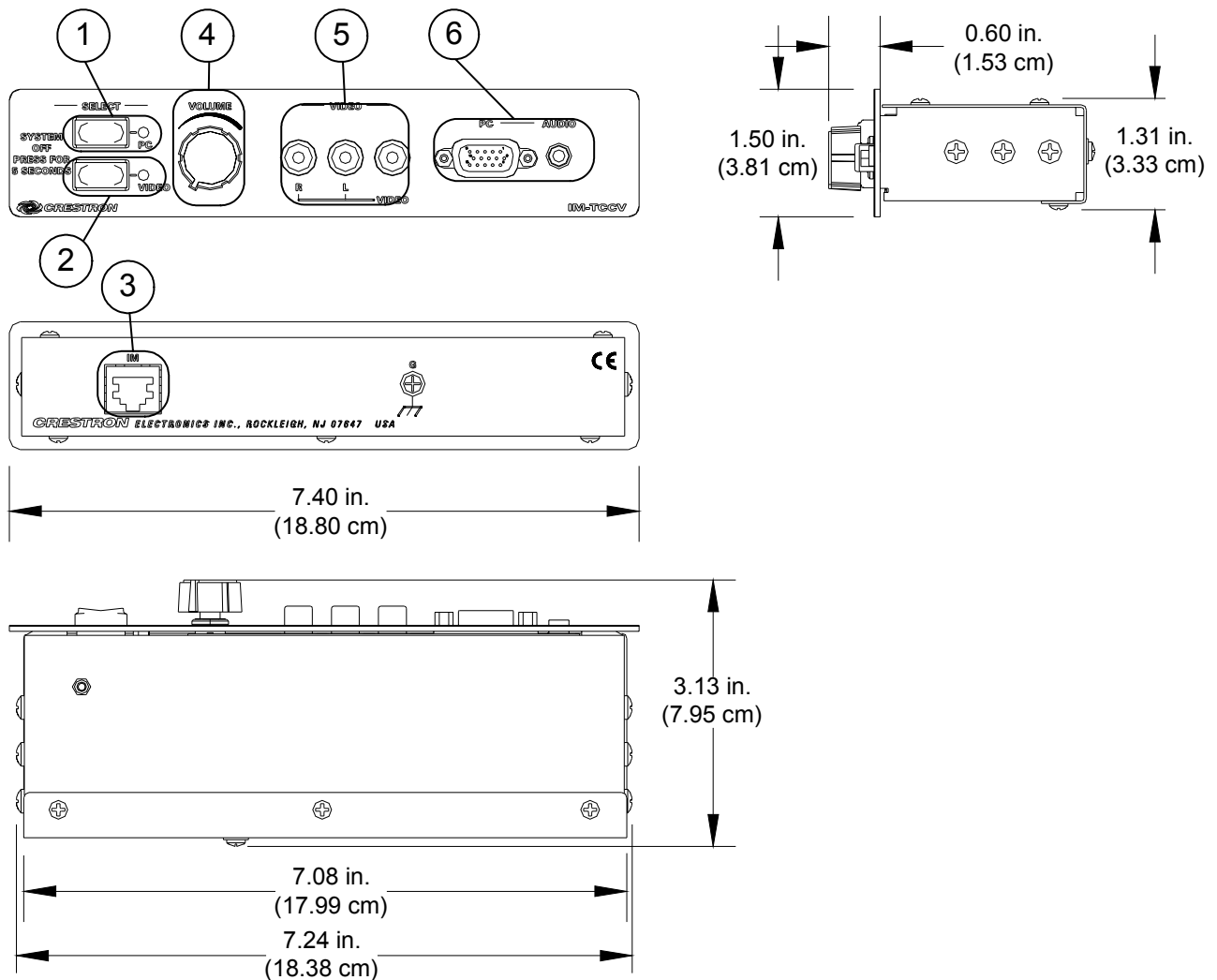

Connectors, Controls, & Indicators

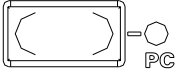
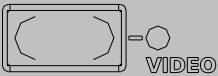
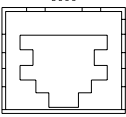
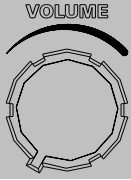
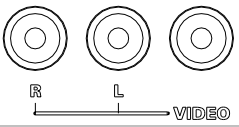
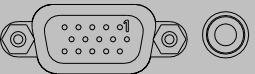
#	CONNECTORS, CONTROLS, & INDICATORS	DESCRIPTION																																				
1	<p>PC BUTTON</p> 	Turns on the system and selects the source connected to the PC input of the IM-TCCV.*																																				
2	<p>VIDEO BUTTON</p> 	Turns on the system and selects the source connected to the VIDEO input of the IM-TCCV.*																																				
3	<p>IM</p> 	(1) Female RJ-45 connector for iMedia connection to IM-RXV1 or IM-RXV3 receiver over CresCAT-IM cable or other high-quality CAT5 wire. For iMedia pin assignments, refer to the chart on page 8.																																				
4	<p>VOLUME CONTROL KNOB</p> 	Turn clockwise to raise the volume of the selected input; turn counterclockwise to lower the volume of the selected input.																																				
5	<p>VIDEO</p> 	(1) RCA-type female connector for composite video input. (1) Pair of RCA-type female connectors for audio feed of composite video input.																																				
6	<p>PC</p> 	<p>(1) Female DB15HD connector is used for connecting a computer's RGB video output to the display device.</p> <p>The following table lists pin assignments:</p> <table border="1"> <thead> <tr> <th>PIN</th> <th>FUNCTION</th> <th>PIN</th> <th>FUNCTION</th> </tr> </thead> <tbody> <tr> <td>1</td> <td>Red Video</td> <td>9</td> <td>No Connect</td> </tr> <tr> <td>2</td> <td>Green Video</td> <td>10</td> <td>Ground</td> </tr> <tr> <td>3</td> <td>Blue Video</td> <td>11</td> <td>No Connect</td> </tr> <tr> <td>4</td> <td>Reserved</td> <td>12</td> <td>Monitor Sense 1</td> </tr> <tr> <td>5</td> <td>Ground</td> <td>13</td> <td>Horizontal Sync</td> </tr> <tr> <td>6</td> <td>Red Ground</td> <td>14</td> <td>Vertical Sync</td> </tr> <tr> <td>7</td> <td>Green Ground</td> <td>15</td> <td>Monitor Sense 2</td> </tr> <tr> <td>8</td> <td>Blue Ground</td> <td></td> <td></td> </tr> </tbody> </table> <p>(1) 3.5mm female mini-jack connects to audio output of PC.</p>	PIN	FUNCTION	PIN	FUNCTION	1	Red Video	9	No Connect	2	Green Video	10	Ground	3	Blue Video	11	No Connect	4	Reserved	12	Monitor Sense 1	5	Ground	13	Horizontal Sync	6	Red Ground	14	Vertical Sync	7	Green Ground	15	Monitor Sense 2	8	Blue Ground		
PIN	FUNCTION	PIN	FUNCTION																																			
1	Red Video	9	No Connect																																			
2	Green Video	10	Ground																																			
3	Blue Video	11	No Connect																																			
4	Reserved	12	Monitor Sense 1																																			
5	Ground	13	Horizontal Sync																																			
6	Red Ground	14	Vertical Sync																																			
7	Green Ground	15	Monitor Sense 2																																			
8	Blue Ground																																					

* Refer to "Operation" on page 13 for more information.

Industry Compliance

As of the date of manufacture, the IM-TCCV has been tested and found to comply with specifications for CE marking and standards per EMC and Radiocommunications Compliance Labelling.



NOTE: This device complies with part 15 of the FCC rules. Operation is subject to the following two conditions: (1) this device may not cause harmful interference, and (2) this device must accept any interference received, including interference that may cause undesired operation.

This equipment has been tested and found to comply with the limits for a Class B digital device, pursuant to part 15 of the FCC Rules. These limits are designed to provide reasonable protection against harmful interference in a residential installation. This equipment generates, uses and can radiate radio frequency energy and, if not installed and used in accordance with the instructions, may cause harmful interference to radio communications. However, there is no guarantee that interference will not occur in a particular installation. If this equipment does cause harmful interference to radio or television reception, which can be determined by turning the equipment off and on, the user is encouraged to try to correct the interference by one or more of the following measures:

- Reorient or relocate the receiving antenna.
 - Increase the separation between the equipment and receiver.
 - Connect the equipment into an outlet on a circuit different from that to which the receiver is connected.
 - Consult the dealer or an experienced radio/TV technician for help.
-

Setup

Network Wiring

When wiring an iMedia system, consider the following:

- Use Crestron Certified Wire.
- Use Crestron power supplies for Crestron equipment.

IM Wiring

Using a proprietary signal routing solution, RGBHV, composite video, audio, power and control signals are all transported using a single cable solution called iMedia.

The iMedia transport system port is capable of managing computer RGB, composite video, and audio signals simultaneously through one CresCAT-IM cable, simplifying installations.



Routing CresCAT-IM cable (low-skew CAT5e) is less expensive and a much simpler solution for the wiring of iMedia systems than routing multi-colored, multi-conductor coax cable. All Crestron products using the iMedia transport system are capable of sending and receiving iMedia signals via CresCAT-IM cable. Installation of any iMedia device is as simple as installing one iMedia cable from output to input. Installations are affordable, and fast.

Quantity and Packaging

- CRESCAT-IM-P-B500 is a low-skew CAT5e cable, plenum-rated, available in a 500 foot box
- CRESCAT-IM-P-SP500 is a low-skew CAT5e cable, plenum-rated, available in a 500 foot spool
- CRESCAT-IM-P-SP1000 is a low-skew CAT5e cable, plenum-rated, available in a 1000 foot spool

For more information on CresCAT and other wire products, visit the Crestron website (www.crestron.com/features/wire).

Pin Assignments

The pin assignment is based on the EIA/TIA 568B RJ-45 Jack standard.

Power is supplied to the IM transmitters via the audio circuit.

To determine which pin is number 1, hold the cable so that the end of the eight pin modular jack is facing you, with clip down and copper side up. When looking down at the copper connections, pin 1 is on the far right.

iMedia Pin Assignment

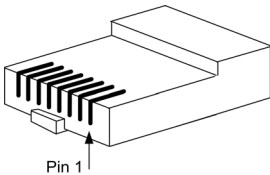
RJ-45 Male Connector	RJ-45 Pin Number	Wire Colors	iMedia Assignment RGB, Composite and Audio
	1	White/Orange	- RGB Red
	2	Orange	+ RGB Red
	3	White/Green	- RGB Green
	4	Blue	+ Audio/Power
	5	White/Blue	- Audio/Power
	6	Green	+ RGB Green
	7	White/Brown	- RGB Blue / Composite
	8	Brown	+ RGB Blue / Composite

NOTE: Power is supplied to pins 4 and 5 from the IM receivers.

Signal Selection

The RGB signal connected to the IM transmitter is delivered to the display device (e.g., projector) via the RGBHV output of an IM receiver. The composite video signal connected to the IM transmitter is delivered to the display device (e.g., projector) via the composite video output of an IM receiver. Each IM transmitter possesses a **SELECT** button (IM transmitters with video have two **SELECT** buttons) that activates an input. The receiver automatically routes the last activated input to the RGB or composite video output and deactivates any prior selection. In addition, the display's power and input selection commands can be controlled via the IR or COM port.

Video Resolution and Cable Length

The receiver can accomplish frequency compensation on each input to achieve correct operation. This compensation scheme is effective for CresCAT-IM cables as long as the maximum skew of 15 ns per 100 m is not exceeded.

NOTE: For proper operations and performance of every iMedia system, always use CresCAT-IM cable.

Maximum Resolution and Cable Length

RESOLUTION	REFRESH RATE (HZ)	PIXEL RATE (MHZ)	PIXEL TIME (NS)	MAX LENGTH (FEET)
VGA (640 X 480)	60	25.18	39.7	218.5
	72	31.50	31.7	174.6
	85	36.00	27.8	152.8
SVGA (800 X 600)	56	36.00	27.8	152.8
	72	50.00	20.0	110.0
	85	56.25	17.8	97.8

(Continued on following page)

Maximum Resolution and Cable Length (Continued)

RESOLUTION	REFRESH RATE (HZ)	PIXEL RATE (MHZ)	PIXEL TIME (NS)	MAX LENGTH (FEET)
XGA (1024 X 768)	60	65.00	15.4	84.6
	70	75.00	13.3	73.3
	85	94.50	10.6	58.2
SXGA (1280 X 1024)	60	108.00	9.3	50.9
	75	135.00	7.4	40.7
	85	157.50	6.3	34.9
UXGA (1600 X 1200)	60	162.00	6.2	34.0
	70	189.00	5.3	29.1
	85	229.50	4.4	24.0
COMPOSITE VIDEO				218.5

Installation

The IM-TCCV is designed to mount in a cutout area or to the underside of a horizontal surface, such as a desktop, lectern, or podium.

Tools Required

- Phillips screwdriver
- Drill/Driver (for underside mounting only)
- (4) #6 hardware screws (for underside installation only)

NOTE: The IM-TCCV mounting brackets can accommodate virtually any mounting surface thickness.

Mounting Parts Supplied with the IM-TCCV

PART DESCRIPTION	QUANTITY
Screw #8-32 x 1 in, Pan Head, Phillips	2
Mounting Bracket, Right (2012702)	1
Mounting Bracket, Left (2012704)	1

Cutout Installation

The following assumes that a rectangular cutout for the IM-TCCV (refer to the cutout dimensions in the following diagram, not drawn to scale) has been made in the mounting surface. A template is included to provide accurate measurements.

Cutout Diagram

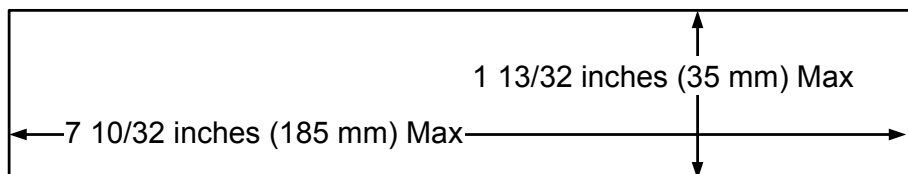

1. Position the IM-TCCV in the mounting hole.

2. Install the left and right brackets:
 - a. Remove the four rear-most screws from the sides of the IM-TCCV as shown in the following diagram.

Remove Side Screws

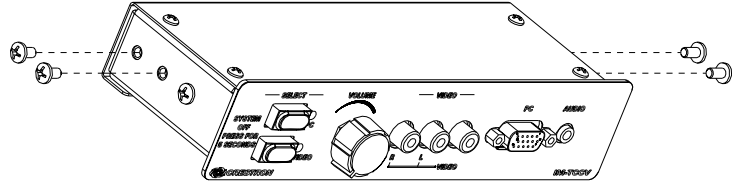

- b. Install the left and right brackets using the cover screws as shown in the following diagram.

Install Brackets

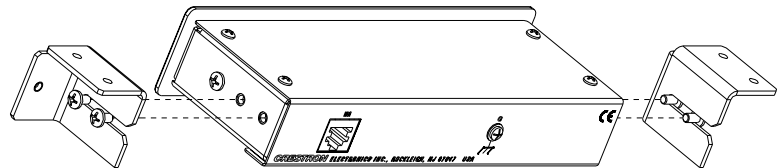

3. Install the supplied #6-32 screws and tighten the screws until they contact the backside of the mounting surface but do not over-tighten.

Install Mounting Screw

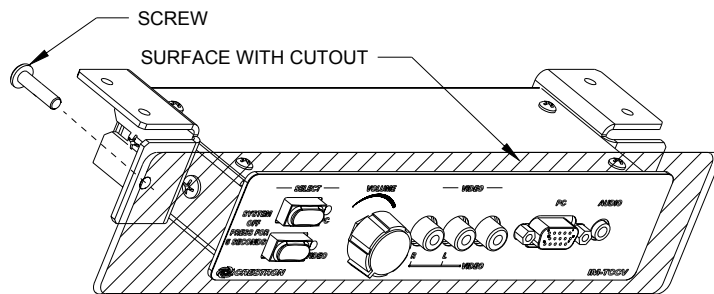

NOTE: Do not over-tighten the screws as this may damage the surface and/or the unit.

Underside Installation

1. Install the left and right brackets:
 - a. Remove the four rear-most screws from the sides of the IM-TCCV as shown in the following diagram.

Remove Side Screws

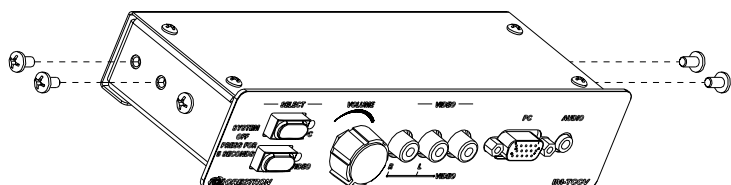

- b. Install the left and right brackets using the cover screws as shown in the following diagram.

Install Brackets

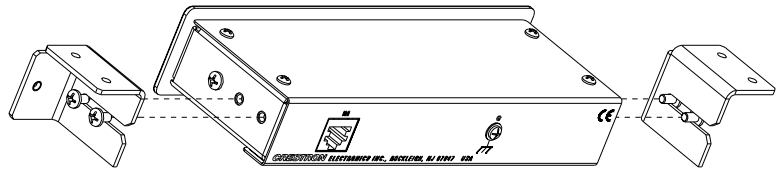

- 2. Use a drill/driver to install four #6 hardware screws (not supplied) in the top holes of the brackets to secure the unit to the underside of the mounting surface.

Install Hardware Screws

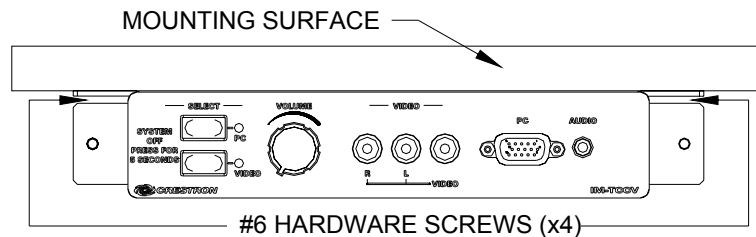

NOTE: Do not over-tighten the screws as this may damage the surface and/or the unit.

Hardware Hookup

Ventilation

To prevent overheating, do not operate this product in an area that exceeds the environmental temperature range listed in the table of specifications. Consideration must be given if installed in a closed or multi-unit rack assembly since the operating ambient temperature of the rack environment may be greater than the room ambient. Contact with thermal insulating materials should be avoided on all sides of the unit.

Connect the Device

Make the necessary connections as called out in the illustrations that follow this paragraph. Turn on the system only after all connections have been made.

Hardware Connections for the IM-TCCV (Rear)

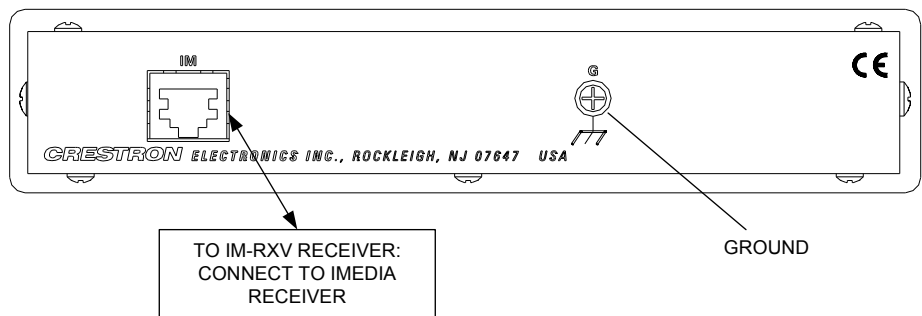

NOTE: For optimum performance, Crestron strongly recommends using CRES CAT-IM cable, available from Crestron. Other high-quality/low skew CAT5e/CAT6 wiring may also be used with varying performance.

Hardware Connections for the IM-TCCV (Front)

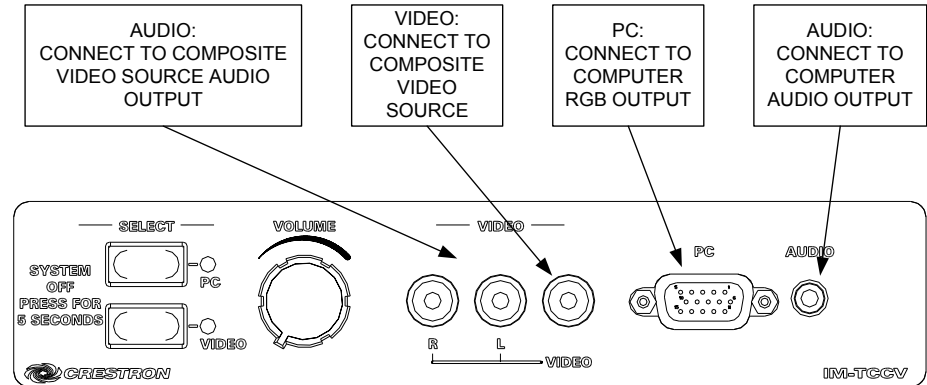

System Configuration

Refer to the latest version of the IM-RXV1 & IM-RXV3 guide (Doc. 6478), available from the Crestron website (www.crestron.com/manuals) for iMedia system configuration instructions.

Operation

The IM-TCCV can be used to turn a system on or off, select a source, or adjust volume.

Turn on the System

Press the **PC** button to turn on the system with the PC signals routed to the iMedia receiver or press the **VIDEO** button to turn on the system with the video signals routed to the iMedia receiver. The associated LED will light to indicate the selected source.

Select a Source

Press the **PC** button to route PC signals to the iMedia receiver or press the **VIDEO** button to route video signals to the iMedia receiver. The associated LED will light to indicate the selected source.

Adjust Volume

Turn the volume knob clockwise to raise the volume of the selected input; turn counterclockwise to lower the volume of the selected input.

Turn off the System

Press and hold the selected source button for five seconds. The source button LED will flash and then turn off.

Problem Solving

Troubleshooting

The following table provides corrective action for possible trouble situations. If further assistance is required, please contact a Crestron customer service representative.

IM-TCCV Troubleshooting

TROUBLE	POSSIBLE CAUSE(S)	CORRECTIVE ACTION
SOURCE LED does not illuminate.	Not receiving power.	Verify that the iMedia cable is connected to the IM-TCCV.
	Incorrect power supply.	Only use Crestron power supplies.
	Source is not selected.	Push a source button on the IM-TCCV to select a source.
No video output displayed.	Incorrect cable connection.	Verify computer cable connection.
		Verify video cable connection.
		Verify iMedia output cable connection is secure.
No audio output.	Incorrect cable connection.	Verify computer audio cable connection.
		Verify video input's audio cable connection.
Video from RGB source is garbled or no output.	Incorrect cable connections.	Verify 15-pin computer cable connection. Verify iMedia output cable connections.
		Verify maximum iMedia cable length. Adjust delay on iMedia receiver.
Button does not function when pressed.	Incorrect cable connection.	Verify that the iMedia output cable connection from the IM-TCCV to the iMedia receiver is secure.
Other functions operate, but does not control the projector.	Incorrect connections to projector.	Verify cable wiring and connections between receiver and projector.

Reference Documents

The latest version of all documents mentioned within the guide can be obtained from the Crestron website (<http://www.crestron.com/manuals>). This link will provide a list of product manuals arranged in alphabetical order by model number.

List of Related Reference Documents

DOCUMENT TITLE
IM-RXV1 & IM-RXV3 iMedia Receiver/Processor with Video

Further Inquiries

If you cannot locate specific information or have questions after reviewing this guide, please take advantage of Crestron's award winning customer service team by calling the Crestron corporate headquarters at 1-888-CRESTRON [1-888-273-7876]. For assistance in your local time zone, refer to the Crestron website (<http://www.crestron.com/>) for a listing of Crestron worldwide offices.

You can also log onto the online help section of the Crestron website to ask questions about Crestron products. First-time users will need to establish a user account to fully benefit from all available features.

Future Updates

As Crestron improves functions, adds new features, and extends the capabilities of the IM-TCCV, additional information may be made available as manual updates. These updates are solely electronic and serve as intermediary supplements prior to the release of a complete technical documentation revision.

Check the Crestron website periodically for manual update availability and its relevance. Updates are identified as an “Addendum” in the Download column.

Return and Warranty Policies

Merchandise Returns / Repair Service

1. No merchandise may be returned for credit, exchange, or service without prior authorization from CRESTRON. To obtain warranty service for CRESTRON products, contact an authorized CRESTRON dealer. Only authorized CRESTRON dealers may contact the factory and request an RMA (Return Merchandise Authorization) number. Enclose a note specifying the nature of the problem, name and phone number of contact person, RMA number, and return address.
2. Products may be returned for credit, exchange, or service with a CRESTRON Return Merchandise Authorization (RMA) number. Authorized returns must be shipped freight prepaid to CRESTRON, 6 Volvo Drive, Rockleigh, N.J. or its authorized subsidiaries, with RMA number clearly marked on the outside of all cartons. Shipments arriving freight collect or without an RMA number shall be subject to refusal. CRESTRON reserves the right in its sole and absolute discretion to charge a 15% restocking fee, plus shipping costs, on any products returned with an RMA.
3. Return freight charges following repair of items under warranty shall be paid by CRESTRON, shipping by standard ground carrier. In the event repairs are found to be non-warranty, return freight costs shall be paid by the purchaser.

CRESTRON Limited Warranty

CRESTRON ELECTRONICS, Inc. warrants its products to be free from manufacturing defects in materials and workmanship under normal use for a period of three (3) years from the date of purchase from CRESTRON, with the following exceptions: disk drives and any other moving or rotating mechanical parts, pan/tilt heads and power supplies are covered for a period of one (1) year; touchscreen display and overlay components are covered for 90 days; batteries and incandescent lamps are not covered.

This warranty extends to products purchased directly from CRESTRON or an authorized CRESTRON dealer. Purchasers should inquire of the dealer regarding the nature and extent of the dealer's warranty, if any.

CRESTRON shall not be liable to honor the terms of this warranty if the product has been used in any application other than that for which it was intended, or if it has been subjected to misuse, accidental damage, modification, or improper installation procedures. Furthermore, this warranty does not cover any product that has had the serial number altered, defaced, or removed.

This warranty shall be the sole and exclusive remedy to the original purchaser. In no event shall CRESTRON be liable for incidental or consequential damages of any kind (property or economic damages inclusive) arising from the sale or use of this equipment. CRESTRON is not liable for any claim made by a third party or made by the purchaser for a third party.

CRESTRON shall, at its option, repair or replace any product found defective, without charge for parts or labor. Repaired or replaced equipment and parts supplied under this warranty shall be covered only by the unexpired portion of the warranty.

Except as expressly set forth in this warranty, CRESTRON makes no other warranties, expressed or implied, nor authorizes any other party to offer any warranty, including any implied warranties of merchantability or fitness for a particular purpose. Any implied warranties that may be imposed by law are limited to the terms of this limited warranty. This warranty statement supersedes all previous warranties.

Trademark Information

All brand names, product names, and trademarks are the sole property of their respective owners. Windows is a registered trademark of Microsoft Corporation. Windows95/98/Me/XP and WindowsNT/2000 are trademarks of Microsoft Corporation.

This page intentionally left blank.

This page intentionally left blank.

This page intentionally left blank.



Crestron Electronics, Inc.
15 Volvo Drive Rockleigh, NJ 07647
Tel: 888.CRESTRON
Fax: 201.767.7576
www.crestron.com

**Operations & Installation Guide – DOC. 6481
(2015046)
05.06**
Specifications subject to
change without notice.