

Crestron **ATC-AUDIONET**
Internet Radio Tuner Card

Operations & Installation Guide



This document was prepared and written by the Technical Documentation department at:



Crestron Electronics, Inc.
15 Volvo Drive
Rockleigh, NJ 07647
1-888-CRESTRON

Regulatory Compliance

As of the date of manufacture, the ATC-AUDIONET has been tested and found to comply with specifications for CE marking and standards per EMC and Radiocommunications Compliance Labelling.



Federal Communications Commission (FCC) Compliance Statement

This device complies with part 15 of the FCC Rules. Operation is subject to the following conditions:

(1) This device may not cause harmful interference and (2) this device must accept any interference received, including interference that may cause undesired operation.

CAUTION: Changes or modifications not expressly approved by the manufacturer responsible for compliance could void the user's authority to operate the equipment.

NOTE: This equipment has been tested and found to comply with the limits for a Class B digital device, pursuant to part 15 of the FCC Rules. These limits are designed to provide reasonable protection against harmful interference in a residential installation. This equipment generates, uses and can radiate radio frequency energy and, if not installed and used in accordance with the instructions, may cause harmful interference to radio communications. However, there is no guarantee that interference will not occur in a particular installation. If this equipment does cause harmful interference to radio or television reception, which can be determined by turning the equipment off and on, the user is encouraged to try to correct the interference by one or more of the following measures:

- Reorient or relocate the receiving antenna
- Increase the separation between the equipment and receiver
- Connect the equipment into an outlet on a circuit different from that to which the receiver is connected
- Consult the dealer or an experienced radio/TV technician for help

Industry Canada (IC) Compliance Statement

Operation is subject to the following two conditions:

1. This device may not cause interference, and
2. This device must accept any interference, including interference that may cause undesired operation of the device.

This device includes an aggregation of separate independent works that are each generally copyrighted by Crestron Electronics, Inc., with all rights reserved. The Linux Kernel 2.6.22 (as modified by Freescale), Mplayer, and Busybox are copyrighted under the GNU GENERAL PUBLIC LICENSE, Version2, reproduced in "GNU General Public License" on page 39, where the corresponding source code is available at: <ftp://ftp.crestron.com/gpl>.

Crestron, the Crestron logo, Adagio, Crestron Toolbox, and SystemBuilder are either trademarks or registered trademarks of Crestron Electronics, Inc. in the United States and other countries. Mac and Finder are either trademarks or registered trademarks of Apple Inc. in the U.S. and/or other countries.

RealAudio is either a trademark or registered trademark of RealNetworks, Inc. in the United States and/or other countries. SIRIUS, XM are either trademarks or registered trademarks of Sirius XM Radio Inc. in the United States and/or other countries. Windows is either a trademark or registered trademark of Microsoft Corporation in the United States and/or other countries. Other trademarks and trade names may be used in this document to refer to either the entities claiming the marks and names or their products. Crestron disclaims any proprietary interest in the marks and names of others.

©2011 Crestron Electronics, Inc.

Contents

Internet Radio Tuner Card: ATC-AUDIONET	1
Introduction	1
Features and Functions	1
Specifications	3
Physical Description	4
Setup	6
Installation	6
Ethernet Configuration	7
Hardware Hookup	8
Programming Software	10
Earliest Version Software Requirements for the PC	10
Programming with SystemBuilder	10
Programming with SIMPL Windows	10
Uploading and Upgrading	13
Establishing Communication	13
Firmware	14
Memory Card	14
Operation	16
Front Panel Controls	16
Web Interface	16
Problem Solving	23
Notes on Internet Radio	23
Troubleshooting	23
Reference Documents	24
Further Inquiries	24
Future Updates	24
Appendix	25
CEN-TRACK	25
AES/AMS/AMS-AIP	25
GNU General Public License	39
Return and Warranty Policies	42
Merchandise Returns / Repair Service	42
CRESTRON Limited Warranty	42

Internet Radio Tuner Card: ATC-AUDIONET

Introduction

The Internet Radio Tuner Card (ATC-AUDIONET) provides a solution for integrating Internet radio as part of a complete Crestron® entertainment system. The ATC-AUDIONET adds Internet radio reception to any Adagio® AES, AMS or AMS-AIP, as well as to the CEN-TRACK Tuner Rack (all sold separately).

Features and Functions

- Occupies a single tuner slot in a CEN-TRACK, AES, AMS, or AMS-AIP
- Provides a single tuner with analog and digital outputs
- Access virtually any streaming radio station in the world without a subscription
- Optional SiriusXM™ online radio service available with subscription
- Controllable via the host's front panel, touch screen, or Web interface
- Browse by format, location, or language
- Search alphanumerically or by keyword
- Enjoy virtually any audio stream with a URL
- Save and organize user favorites for fast access
- Supports WAV, MP3, WMA, AAC, and RealAudio® formats
- Supports the display of metadata and graphics for stations that support them
- Provides transport controls for stations and podcasts that support them
- Can also be used to play sound files, pre-recorded announcements, or background music stored on its internal memory card or external Web server
- Requires no antenna, just a broadband connection

The World of Internet Radio

Crestron Internet radio lets you easily browse and search through over 15,000 free online radio stations and podcasts and instantly play them throughout your home or office without requiring a separate computer. From a Crestron touch screen or Web browser, you can browse the station guide by format, location, or language. Or, search for a specific station or podcast by name, call letters, or any other keywords. Then save and organize your favorites for easy recall at any time.

The station guide is constantly updated with diverse programming from around the world, so whether you are looking for news and entertainment from your local community radio station or from your homeland on another continent, you will almost certainly find it with Internet Radio.

Crestron's Internet radio even gives you access to SiriusXM Internet Radio with your paid subscription¹, and lets you listen to free audiobooks courtesy of LibriVox.org. Additional services may be added in the future.

An Enhanced Touch Screen Experience

Enjoying your choice of music, talk, books, and other content via Internet Radio is enhanced through support for metadata and transport controls. Many Internet radio stations let you view detailed information about what is currently playing, and some even let you pause, rewind, repeat, or skip tracks as they are playing. Internet Radio enables access to these features for those stations that support them right through your Crestron touch screen.

Modular Tuner Card

The ATC-AUDIONET is available for Adagio AES, AMS, and AMS-AIP systems, as well as for the CEN-TRACK Tuner Rack Modular Multi-Tuner. With any of these devices, the ATC-AUDIONET can be installed in any available tuner card slot, providing a single Internet radio tuner alongside other AM/FM, satellite, or additional ATC-AUDIONET tuner cards. The card provides both stereo analog and S/PDIF digital output signals², and when installed in an Adagio system its output feeds only the first input associated with the card slot in which it is installed³.

With Internet radio, there are no clumsy antennas needed to gain access to all the different content that is available. To enable Internet radio service using the ATC-AUDIONET, each card requires an Ethernet connection to the control system LAN with broadband access to the Internet.

Web Browser Management

Finding and managing all your favorite Internet radio stations is a breeze using the Crestron Internet Radio Web site. Simply register your tuner card at <http://radio.crestron.com> and begin exploring all the available stations through your computer's Web browser. Use live preview to listen to each station right on your computer, then save the ones you want to access from your control system touch screen or handheld remote, and filter out all the ones that do not interest you. Even add unlisted stations by simply entering the URL of any compatible stream.

1. SiriusXM Internet Radio requires subscription. Contact SiriusXM Radio Inc. for details.
2. Output capabilities dependent upon the connectivity provided by the host device. Digital output is only enabled using the CEN-TRACK.
3. The second input associated with the occupied card slot remains available to accept the output of an external source device.

Extra Features

The ATC-AUDIONET card provides additional capabilities for the playback of audio files loaded on its internal memory card. Use it to generate door chimes, phone ringers, alarms and other sounds, or to play pre-recorded music and announcements. Sound files and playlists can be loaded from any networked computer using a Samba-compatible file manager like Windows[®] Explorer or Mac[®] Finder[®]. Playing a file or playlist is enabled through your control system program, allowing any sound to be scheduled or triggered manually via a button press or any other control event.

The ATC-AUDIONET can also stream any compatible audio file that has a URL address, providing a means for accessing Internet radio stations that are not included in the station guide, or for streaming custom sound files loaded on a local Web server.

Specifications

Specifications for the ATC-AUDIONET are listed in the following table.

ATC-AUDIONET Specifications

SPECIFICATION	DETAILS
Audio	
Analog Output Level	2 V _{rms} Maximum
Digital Output	44.1k 16-bit S/PDIF
Streaming/File Formats	WAV, MP3, WMA, AAC, and RealAudio [®]
Communications	
Ethernet	10/100 Mbps, auto-switching, auto-negotiating, auto-discovery, full/half duplex, TCP/IP, UDP/IP, CIP, DHCP, RTSP
Memory	
Internal Memory Card	Expandable up to 8 GB using MMC compatible card (512 MB card included)
Environmental	
Temperature	32° to 140° F (0° to 60° C)
Humidity	10% to 90% RH (non-condensing)
Dimensions	
Height	1.39 in (35 mm)
Width	4.91 in (125 mm)
Depth	6.19 in (158 mm)
Weight	5 oz (140 g)

Physical Description

This section provides information on the connections, controls and indicators available on the ATC-AUDIONET.

ATC-AUDIONET Physical View

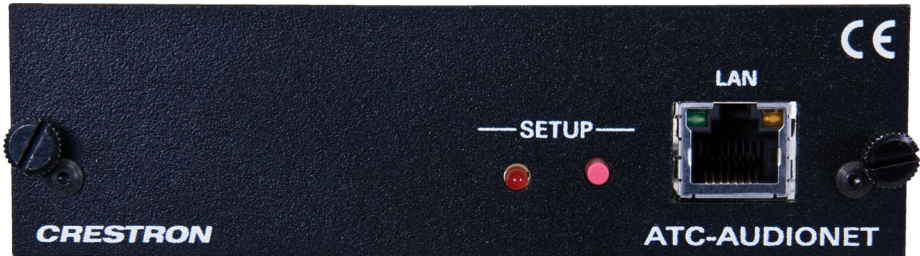

ATC-AUDIONET Overall Dimensions

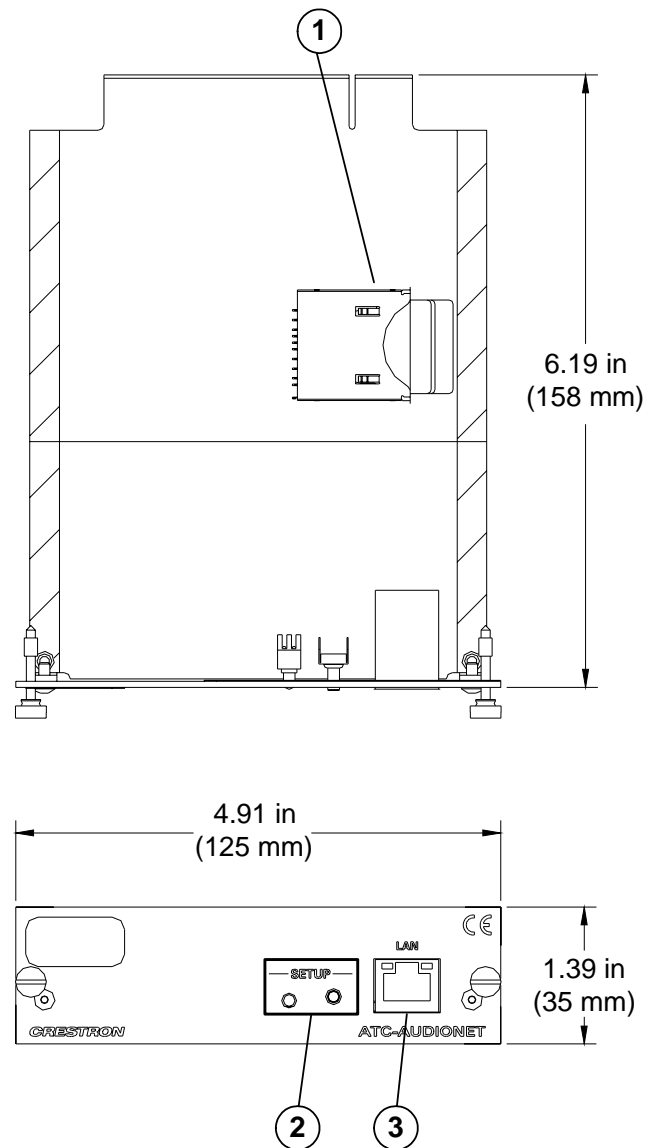

Connectors, Controls & Indicators

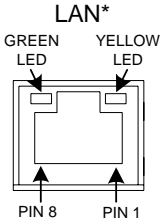
#	CONNECTORS, CONTROLS & INDICATORS	DESCRIPTION																				
1	MEMORY CARD SLOT	Slot for removable Multimedia Memory Card (MMC). Includes (1) 512 MB MMC card; Supports up to 8 GB MMC card.																				
2	SETUP (LED & Button)	(1) red LED and (1) miniature recessed pushbutton, for Ethernet setup																				
3	<p>LAN*</p> 	<p>(1) 8-wire RJ-45 with 2 LED indicators; 10/100BASE-T Ethernet port; Green LED indicates link status; Yellow LED indicates Ethernet activity</p> <table border="1"> <thead> <tr> <th>PIN</th> <th>SIGNAL</th> <th>PIN</th> <th>SIGNAL</th> </tr> </thead> <tbody> <tr> <td>1</td> <td>TX +</td> <td>5</td> <td>N/C</td> </tr> <tr> <td>2</td> <td>TX -</td> <td>6</td> <td>RX -</td> </tr> <tr> <td>3</td> <td>RX +</td> <td>7</td> <td>N/C</td> </tr> <tr> <td>4</td> <td>N/C</td> <td>8</td> <td>N/C</td> </tr> </tbody> </table>	PIN	SIGNAL	PIN	SIGNAL	1	TX +	5	N/C	2	TX -	6	RX -	3	RX +	7	N/C	4	N/C	8	N/C
PIN	SIGNAL	PIN	SIGNAL																			
1	TX +	5	N/C																			
2	TX -	6	RX -																			
3	RX +	7	N/C																			
4	N/C	8	N/C																			

* To determine which is pin 1 on the cable, hold the cable so the end of the eight pin modular plug is facing away from you, with the clip down and copper side up. Pin 1 is on the far left.

Setup

This section contains hardware installation and setup instructions for the ATC-AUDIONET.

Required Tools/Hardware

- Small flat blade screwdriver
- Grounding strap (encouraged)

Installation

CAUTION: The ATC-AUDIONET and host system contain electrostatic discharge (ESD) sensitive devices. Crestron encourages you to wear a grounding strap to avoid damaging the card and/or the host system.

For AES, AMS, and AMS-AIP Only

When inserting a card into an Adagio system that features tuner card slots you may need to move other source connections if designated connectors are occupied by other sources. For programming purposes, slots and source connections are matched according to the following table:

	Slot 1	Slot 2	Slot 3
Source Connections	1	3	5

CAUTION: Do not connect external sources to **SOURCES** connectors used by tuner cards.

CAUTION: Be certain to insert tuner card before applying power to the Adagio Entertainment System.

Procedure

To install the ATC-AUDIONET:

1. Disconnect power from the host system.
2. Remove the slotted screws securing any cover plate that may be fastened to the slot you intend to use then set the screws and the cover plate aside.
3. Unpack the ATC-AUDIONET card.
4. If the included memory card is to be used, it should be installed before inserting the ATC-AUDIONET into the system. For details, refer to “Memory Card” which starts on page 8.

5. As shown in the following photo, position the ATC-AUDIONET card so the print on the faceplate is right side up and the side rails of the card slide into the plastic slots mounted on left and right inside walls of the host system.

ATC-AUDIONET Installed in an AMS



6. Push the ATC-AUDIONET card into the slot until it stops at the rear connector, and then push again until the ATC-AUDIONET card snaps into place.
7. Secure the card in place by tightening the two slotted screws by hand. The screwdriver slots are provided for removal only.

Ethernet Configuration

Once the tuner card is installed, users need to specify the Ethernet settings of the ATC-AUDIONET.

NOTE: When installing the ATC-AUDIONET, the IP ID and IP address of the control system need to be specified for the ATC-AUDIONET. This can be done via the front panel controls or a custom program.

NOTE: When installed in an Adagio system, the ATC-AUDIONET will only work with a custom program that includes an ATC-AUDIONET.

NOTE: When installing in an Adagio System, an IP table entry that identifies the host system as the control system must be created in the ATC-AUDIONET's IP table. This is done automatically by SystemBuilder™ but can also be done through Crestron Toolbox™ or through the Installer Tools (available on an Adagio system that was programmed by SystemBuilder to include an ATC-AUDIONET).

For instructions on changing the Ethernet settings, refer to “Appendix” on page 25.

Hardware Hookup

Connect the Device

Make the necessary connections as called out in the illustration that follows this paragraph. Apply power after the **LAN** connection has been made.

Hardware Connections for the ATC-AUDIONET

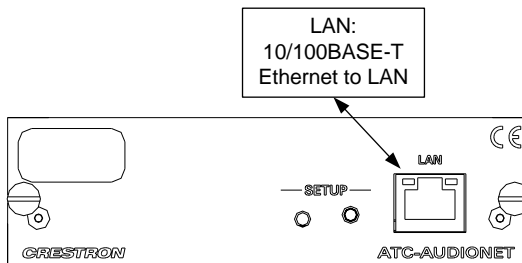

NOTE: To prevent overheating, do not operate this product in an area that exceeds the environmental temperature range listed in the table of specifications.

Memory Card

The ATC-AUDIONET includes a 512 MB Multimedia Memory Card which can be used to store and play supported files.

CAUTION: The ATC-AUDIONET and host system contain electrostatic discharge (ESD) sensitive devices. Crestron encourages you to wear a grounding strap to avoid damaging the card and/or the host system.

To install or remove the memory card:

1. Disconnect power from the host device.
2. If the ATC-AUDIONET is already installed in an AES, AMS, AMS-AIP, or CEN-TRACK, it must be removed.
 - a. Using a flat blade screwdriver, loosen the two slotted screws.
 - b. Gently pull the ATC-AUDIONET from the host device by the loosened screws.
3. Install or remove the memory card.

To install the memory card:

- a. As shown in the following diagram, insert the memory card into the card slot, contacts facing down.

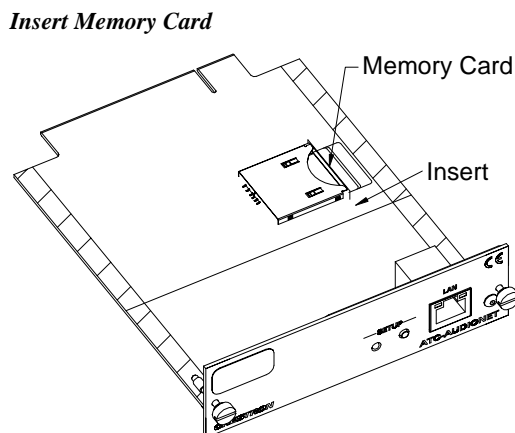

- b. Slide memory card until it clicks into place.

To remove the memory card:

- a. Push the card into the slot to eject the card from the slot.
- b. Slide the memory card from the memory card slot as shown in the following diagram.

Remove Memory Card

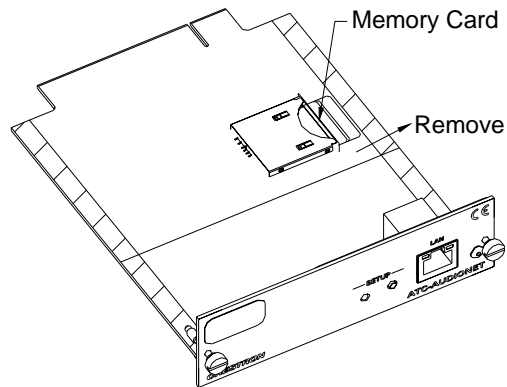

4. Reinstall the ATC-AUDIONET as described in "Installation" which starts on page 6 and connect power to the host device.

Programming Software

NOTE: When an ATC-AUDIONET is installed into a CEN-TRACK, the CEN-TRACK's out-of-the-box program will provide a front panel interface for using the ATC-AUDIONET. A custom program can also be created to use the features of the ATC-AUDIONET.

NOTE: When installed in an AES, AMS, or AMS-AIP, a custom program must be created to use the features of the ATC-AUDIONET.

NOTE: To ensure proper operation, download and install the latest host system firmware from crestron.com/firmware.

Have a question or comment about Crestron software?

Answers to frequently asked questions (FAQs) can be viewed in the Online Help section of the Crestron Web site. To post a question or view questions you have submitted to Crestron's True Blue Support, log in at www.crestron.com/support. First-time users will need to establish a user account.

Earliest Version Software Requirements for the PC

NOTE: Crestron recommends that you use the latest software to take advantage of the most recently released features. The latest software is available from the Crestron Web site.

Crestron has developed an assortment of Windows-based software tools to develop a customized system. Use SystemBuilder or SIMPL Windows to create a program to control the ATC-AUDIONET.

Programming with SystemBuilder

SystemBuilder is the easiest method of programming but does not offer as much flexibility as SIMPL Windows. For additional details, download SystemBuilder from the Crestron Web site and examine the extensive help file.

Programming with SIMPL Windows

NOTE: While SIMPL Windows can be used to program the ATC-AUDIONET, it is recommended to use SystemBuilder for configuring a system.

SIMPL Windows is Crestron's premier software for programming Crestron control systems. It is organized into two separate but equally important "Managers": Configuration and Program.

Any SIMPL Windows program written for an ATC-AUDIONET will contain all of the ATC-AUDIONET's out-of-the-box functions in a protected area of the program. The parts of the program that contain the out-of-the-box functions are locked and

cannot be changed or deleted. When a program is compiled, the custom program plus the out-of-the-box front panel functionality, including setup menus are loaded.

Configuration Manager

Configuration Manager is the view where programmers “build” a Crestron control system by selecting hardware from the *Device Library*.

NOTE: If programming for use in a CEN-TRACK, the CEN-TRACK must already be included as part of the system. The following instructions describe programming for an ATC-AUDIONET that is installed in a CEN-TRACK.

1. To incorporate the ATC-AUDIONET into the system, drag the ATC-AUDIONET from the Plug-in Control Cards | Cards (CEN-TRACK) folder of the *Device Library* and drop it on to a CEN-TRACK in the *System Views*.

Locating the ATC-AUDIONET in the Device Library

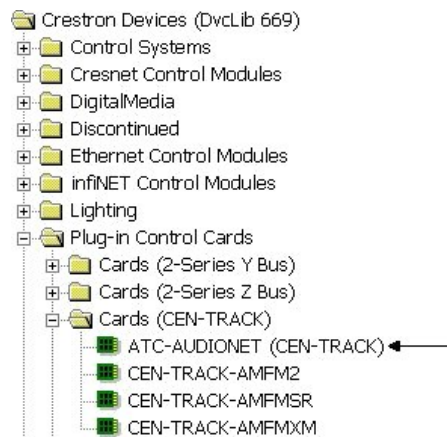

The system tree of the control system displays the device in the CEN-TRACK as shown in the following illustration.

CEN-TRACK, Slot 1

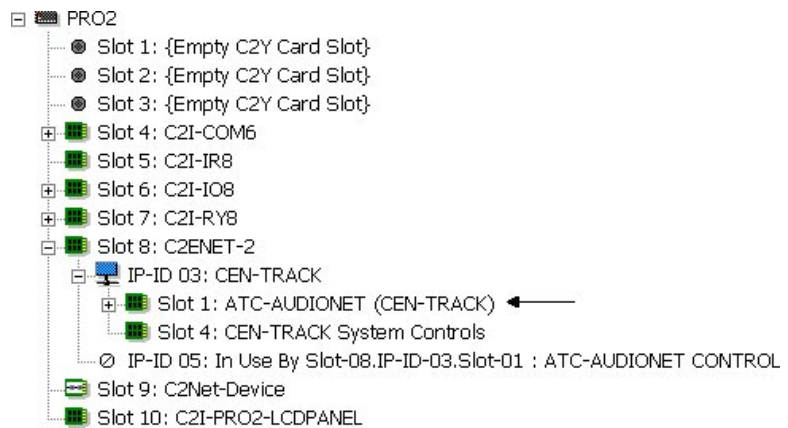

NOTE: The first tuner card added to a CEN-TRACK is assigned to slot 1. The tuner card must be physically installed in the assigned slot.

2. If additional ATC-AUDIONET devices are to be added, repeat step 1 for each device. Each ATC-ADUIONET is assigned a different slot as it is added.

Program Manager

Program Manager is the view where programmers “program” a Crestron control system by assigning signals to symbols.

Signals that are part of the ATC-AUDIONET’s out-of-the-box functionality are locked and cannot be modified or deleted. Locked signals are grayed out in the ATC-AUDIONET’s SIMPL Windows symbols. To prevent corruption of the out-of-the-box functionality, locked signal names should not be copied or driven to other destinations in the SIMPL Windows program.

The symbol can be viewed by double clicking on the icon or dragging it into *Detail View*. Each signal in the symbol is described in the SIMPL Windows help file (**F1**).

Uploading and Upgrading

Crestron recommends using the latest programming software and that each device contains the latest firmware to take advantage of the most recently released features. However, before attempting to upload or upgrade it is necessary to establish communication. Once communication has been established, files (for example, programs or firmware) can be transferred to the control system (and/or device). Finally, program checks can be performed (such as changing the device ID or creating an IP table) to ensure proper functioning.

Establishing Communication

Use Crestron Toolbox for communicating with the ATC-AUDIONET; refer to the Crestron Toolbox help file for details. There is a single method of communication: TCP/IP communication.

Ethernet Communication

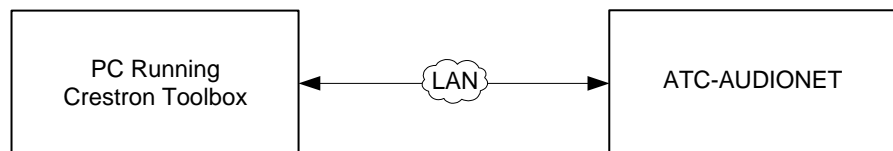

The ATC-AUDIONET connects to PC via Ethernet:

1. Enter the IP address, IP mask and default router of the ATC-AUDIONET via Crestron Toolbox (**Functions | Ethernet Addressing**); otherwise enable DHCP.

NOTE: Use the Device Discovery Tool in Crestron Toolbox to detect all Ethernet devices on the network and their IP configuration. The tool is available in Toolbox version 1.15.143 or later.

NOTE: When taken out of the box, the ATC-AUDIONET is configured for DHCP operation. If a DHCP server is available and the ATC-AUDIONET is connected to the network, the IP address can be obtained from the host device's setup screens. For instructions on using the front panel controls of a host system, please refer to the latest version of the respective Operations guide.

2. Confirm Ethernet connection between ATC-AUDIONET and PC. If connecting through a hub or router, use CAT5 straight through cables with 8-pin RJ-45 connectors. Alternatively, use a CAT5 crossover cable to connect the two LAN ports directly without using a hub or router.
3. Use the Address Book in Crestron Toolbox to create an entry for the ATC-AUDIONET with the ATC-AUDIONET's TCP/IP communication parameters.
4. Display the "System Info" window (click the  icon) and select the ATC-AUDIONET entry.

Firmware

Firmware files may be distributed from programmers to installers or from Crestron to dealers. Firmware upgrades are available from the Crestron Web site as new features are developed after product releases. For details on upgrading refer to the Crestron Toolbox help file.

Upgrade ATC-AUDIONET firmware via Crestron Toolbox.

1. Establish communication with the ATC-AUDIONET and display the “System Info” window.
2. Select **Functions | Firmware...** to upgrade the ATC-AUDIONET firmware.

Memory Card

The memory card on the ATC-AUDIONET can be used to store files that can be used by the control system. Using Windows Explorer or Mac Finder, the memory card can be used as a network drive.

NOTE: A compatible memory card must be installed on the ATC-AUDIONET. Refer to “Memory Card” which starts on page 8 for more information.

To connect with the memory card on the ATC-AUDIONET:

1. Open Windows Explorer or Mac Finder.
2. Enter the IP address or hostname of the ATC-AUDIONET. A login prompt is displayed.

Login Prompt (Windows Explorer)



3. Enter the *User name* **admin** and a password.

NOTE: By default, a password is not assigned. However, a “Samba” password can be created with the front panel controls. Refer to the latest version of the Crestron CEN-TRACK Operations Guide (Doc. 6646) which is available for download from the Crestron Web site (www.crestron.com/manuals).

NOTE: When installed in an Adagio system, front panel controls for setting a “Samba” password are similar to those found on the CEN-TRACK. The controls are only present when a custom program (that includes an ATC-AUDIONET) is running on the Adagio system.

4. Use the mouse to click **OK**. The contents of the memory card are displayed. Files can be managed on the memory card just like any other system directory.

NOTE: On some systems, clicking **OK** will cause the login prompt to refresh with a path name in front of the entered user name. If this happens, repeat steps 3 and 4.

Operation

Front Panel Controls

The ATC-AUDIONET is capable of browsing through thousands of Internet radio stations and podcasts. For instructions on using the front panel controls of a host system, refer to the Appendix on page 25.

Web Interface

In addition to using the front panel controls or a custom interface, Crestron has created a Web site that allows you to manage favorite Internet radio stations and podcasts using a Web browser.

NOTE: The Web site cannot be used to browse SiriusXM online radio or Librivox audiobooks.

Create an Account

To use a Web browser for managing favorite stations and podcasts, an account on the Crestron Internet Radio Web site must be created.

1. Open a Web browser to the Crestron Internet Radio Web site (radio.crestron.com).

Crestron Internet Radio Web site

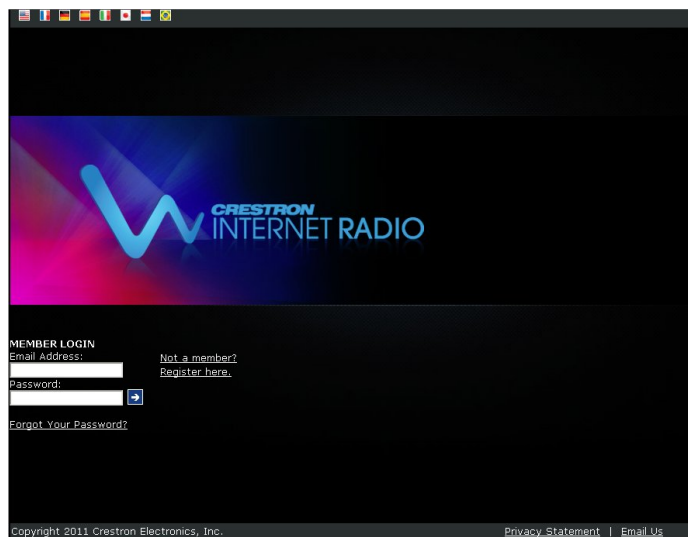

2. Use the mouse to click **Register here..**

Crestron Internet Radio Registration Page

Crestron Internet Radio Registration Page

1. Please enter the Access code for your Media Player (Please refer to your Media Player instruction manual to find your Access code):

Access code:

2. Type in your Email Address, then enter in your Password twice to verify accuracy, click the register link to continue. Please keep track of your password since it will be used every time you log in to your account.

E-Mail Address:

Password: Must be at least 6 characters

Enter Password Again:

Register Cancel

3. The ATC-AUDIONET's access code is required to create an account. To obtain the access code:
 - a. Select the ATC-AUDIONET as the source to control.
 - ⇒ **For CEN-TRACK:** Press the **TUNER** button for the card slot that contains the ATC-AUDIONET.
 - ⇒ **For AES, AMS, and AMS-AIP:** Press the **SOURCE** button, turn the selection knob to display ATC-AUDIONET, and press the **ENTER** button twice.
 - b. Press the soft key labeled **Browse**.
 - c. Turn the **TUNE**/selection knob to highlight **Internet Radio** and press **ENTER**.
 - d. Turn the **TUNE**/selection knob to highlight **Get access code** and press **ENTER**. The access code is displayed.
4. Enter the access code obtained in step 3, an e-mail address, and password in the relevant fields.
5. Use the mouse to click **Register**. The Crestron Internet Radio home page is displayed.

Log In

To use the Crestron Internet Radio Web site, you must log in.

1. Open a Web browser to the Crestron Internet Radio Web site (radio.crestron.com). The login page is displayed.

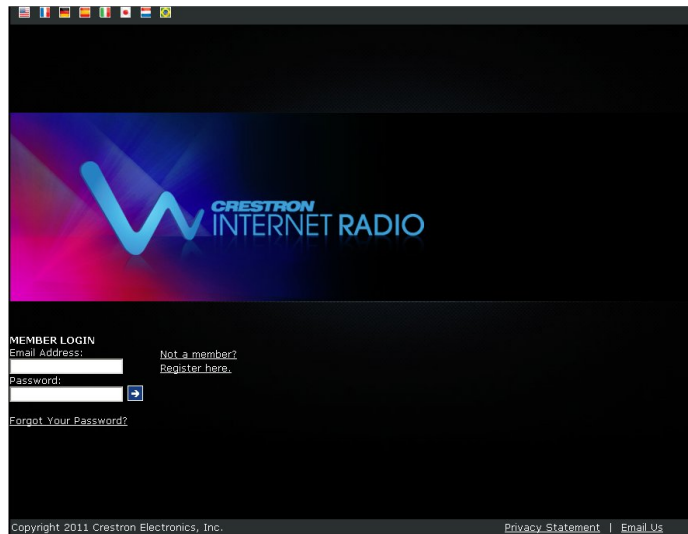
Crestron Internet Radio Web site

2. Enter the account's e-mail address and password in the respective fields and click . If you forgot the account password, use the mouse to click **Forgot Your Password?**

NOTE: If you do not have an account, you must create one. For more information, refer to "Create an Account" which starts on page 16.

Browse Stations

Once logged in, the Crestron Internet Radio home page is displayed. You can browse stations for listening on the computer or adding to favorite groups for recall on a CEN-TRACK, AES, AMS, or AMS-AIP.

Crestron Internet Browse Page

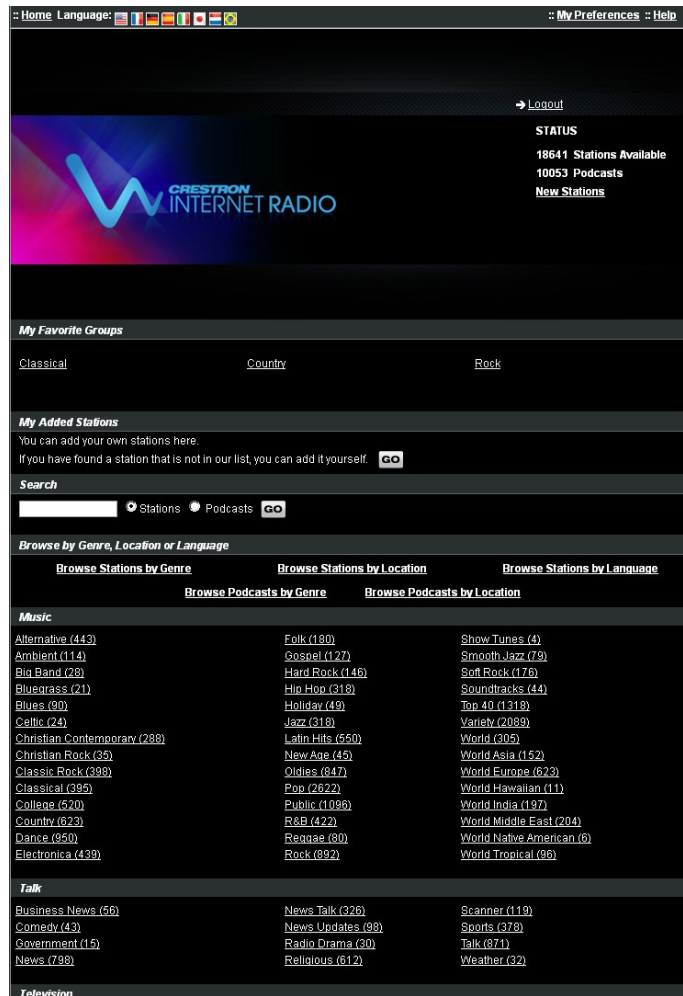

You can browse Internet radio stations and podcasts in a variety of ways:

- **Favorites:** Browse stations within a favorite group.
- **Search Stations/Podcasts:** Search stations and podcast by keyword.
- **Format:** Browse stations and/or podcasts within a specific format.
- **Location:** Browse stations and/or podcasts by geographic location.
- **Language:** Browse stations and/or podcasts by language.

To browse stations and/or podcasts:

1. Log in to the Crestron Internet Radio Web site as described in “Log In” which starts on page 17.
2. Use the mouse to click a browse method. Stations and/or podcasts within the selected method are displayed.

NOTE: Librivox audiobooks and stations from the SiriusXM online feed cannot be browsed from the Crestron Internet Radio Web site.

Crestron Internet Radio Stations, “Rock” Format

The screenshot shows the Crestron Internet Radio website interface. At the top, there are navigation links for Home, My Preferences, and Help. A Logout link is also visible. The main header features the Crestron Internet Radio logo and a status section indicating 18734 Stations Available, 10099 Podcasts, and a link to New Stations. Below the header, there are navigation options to browse stations by Genre, Location, or Language, and to browse podcasts by Genre or Location. A search bar is present with a GO button. The main content area is titled "Stations for Rock" and shows a list of stations with columns for Station Name, Location, Genre, and Stream. The list includes stations like "1.fm Alternative Rock X Hits", "101.ru Rock", and "102.3 The Wire".

Station Name	Location	Genre	Stream
1.fm Alternative Rock X Hits	Internet Only	Rock/Alternative	WMA 34K
1.fm One Live	Internet Only	Rock	WMA 130K
100 X/R	Internet Only	Rock	MP3 128K
101.ru BG & Aquarium	Internet Only	Rock	WMA 130K
101.ru Indie Music	Internet Only	Rock	WMA 130K
101.ru Live Concerts	Internet Only	Rock	WMA 130K
101.ru NRJ Rock	Internet Only	Rock	WMA 130K
101.ru Queen	Internet Only	Rock	WMA 130K
101.ru Rock	Internet Only	Rock	WMA 130K
101.ru Rock Outtar	Internet Only	Rock	WMA 130K
101.ru Rock Koleso	Internet Only	Rock	WMA 130K
101.ru Rock Remakes	Internet Only	Rock	WMA 130K
102 FM Fox	North Bay ON Canada	Rock	MP3 64K
102.3 The Wire	Burlington VT	Rock	WMA 80K
104.6 RTL Best Of Eighties	Berlin Germany	Rock	AAC 65K
104.6 RTL Modern Rock & Pop	Berlin Germany	Rock	AAC 65K

If searching for stations, enter the search term(s), select **Stations** or **Podcasts**, and click **GO**. Stations that meet the search criteria are displayed.

- To listen to a station on your computer, use the mouse to click .

To add a station to a favorite group, use the mouse to click  and follow the instructions for adding the station.

Additional controls are available when browsing favorites. For information on favorites, refer to “Manage Favorites” which starts below.

Manage Favorites

The Crestron Internet Radio Web site can manage favorite stations that can be quickly recalled with the front panel on a CEN-TRACK, AES, AMS, or AMS-AIP. Stations can also be removed from a favorite group.

Add a Station

- Log in to the Crestron Internet Radio Web site as described in “Log In” which starts on page 17.
- Select a browse or search method to display a list of stations.
- To add a station to a favorite group, use the mouse to click . A popup window is displayed prompting the user to select a group to receive the new station.

Select a Favorite Station Group

The station can be added to a new group or to an existing group.

To add the station to a new group, type the new group name and use the mouse to click **Go**. The new group name is displayed in the Crestron Internet Radio browse page.

To add the station to an existing group, use the mouse to select a group from the dropdown menu and then click **Go**. The station is added to the selected group.

To cancel, use the mouse to click **Close**.

Delete a Favorite Station

1. Log in to the Crestron Internet Radio Web site as described in “Log In” which starts on page 17.
2. Use the mouse to select the favorite group that contains the station to be deleted.
3. Click  next to the station to be deleted.

NOTE: SiriusXM stations are visible within a favorite group and can only be removed from a favorite group. They cannot be added to a favorite group nor can they be played from the radio.crestron.com Web site.

NOTE: Clicking  deletes the station from the selected favorite group. The station remains in the station lineup and any other favorite group.

Multiple ATC-AUDIONETs

Multiple ATC-AUDIONETs can be managed under one account.

NOTE: Changes made to favorite station groups will propagate to all ATC-AUDIONET devices that are registered to the e-mail address. For individual control, each ATC-AUDIONET should be registered with a unique e-mail address.

1. Log in to the Crestron Internet Radio Web site as described in “Log In” which starts on page 17.
2. Use the mouse to click **My Preferences**.

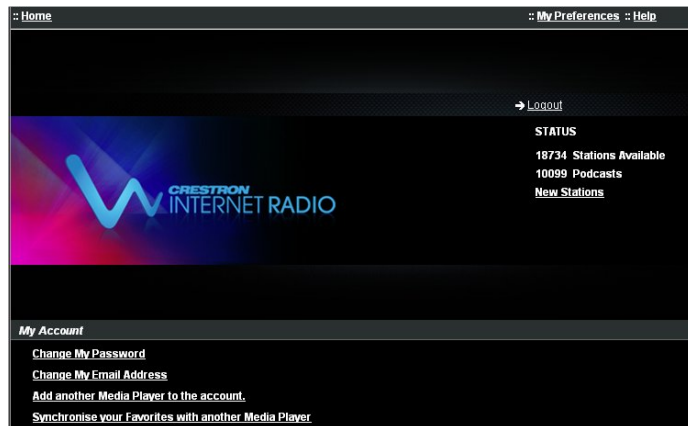
Crestron Internet Radio Preferences Page

3. Use the mouse to click **Add another Media Player to the account.**

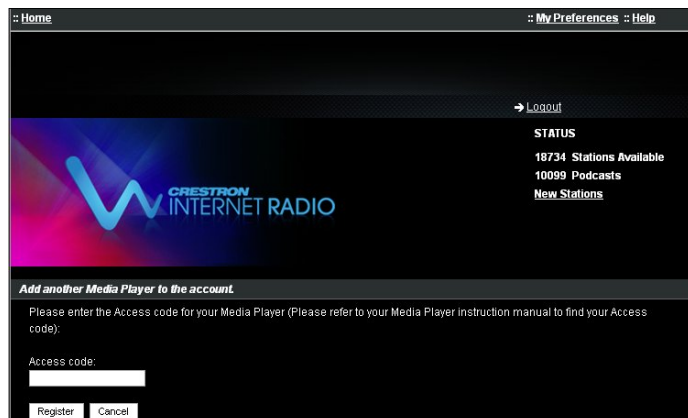
Crestron Internet Radio Add Media Player Page

4. Type the access code and use the mouse to click **Register**.

Problem Solving

Notes on Internet Radio

- Internet radio stations can only support a limited number of listeners at any time. If a station's servers have reached their limit of listeners, the ATC-AUDIONET will not be able to connect. To resolve the problem, wait a few minutes and try to connect again.
- Some radio station servers that have too much traffic may choose to “bump” people off the stream. If this happens, try to connect to the station again.
- If a station stops broadcasting, it is removed from the list of available stations.
- A station may go offline before it has been removed from the list. When the station is tuned, it will not produce a signal.
- Some stations may not appear on the list of stations if they broadcast in a format that is not supported by the ATC-AUDIONET. For a list of supported formats, refer to “Specifications” on page 3.

Troubleshooting

The following table provides corrective action for possible trouble situations. If further assistance is required, please contact a Crestron customer service representative.

ATC-AUDIONET Troubleshooting

TROUBLE	POSSIBLE CAUSE(S)	CORRECTIVE ACTION
Tuner muted.	Mismatched slot.	Place card in proper slot.
	Mute turned on.	Press the Mute button to disengage muting.
	Adagio system volume is turned down.	Check Adagio system volume setting.
Cannot access tuner card controls from front panel.	Dusty contacts on ATC-AUDIONET.	Clean contacts with cotton swab or clean cloth. Apply Isopropyl alcohol as needed for cleaning.
Tuned station does not produce sound.	Firewall settings prevent reception of streaming audio.	Change firewall port settings or contact network administrator.
Cannot receive SiriusXM streaming content.	Need subscription to stream SiriusXM content.	Verify that subscription to streaming SiriusXM content is current.

Reference Documents

The latest version of all documents mentioned within the guide can be obtained from the Crestron Web site (www.crestron.com/manuals). This link will provide a list of product manuals arranged in alphabetical order by model number.

List of Related Reference Documents

DOCUMENT TITLE
Adagio AES Entertainment System
Adagio AMS Media System
Adagio AMS-AIP Media System with Advance Image Processing
CEN-TRACK Tuner Rack

Further Inquiries

If you cannot locate specific information or have questions after reviewing this guide, please take advantage of Crestron's award winning customer service team by calling Crestron at 1-888-CRESTRON [1-888-273-7876]. For assistance in your region, please refer to the Crestron Web site (www.crestron.com) for a listing of Crestron worldwide offices.

You can also log onto the online help section of the Crestron Web site (www.crestron.com/onlinehelp) to ask questions about Crestron products. First-time users will need to establish a user account to fully benefit from all available features.

Future Updates

As Crestron improves functions, adds new features and extends the capabilities of the ATC-AUDIONET, additional information may be made available as manual updates. These updates are solely electronic and serve as intermediary supplements prior to the release of a complete technical documentation revision.

Check the Crestron Web site periodically for manual update availability and its relevance. Updates are identified as an "Addendum" in the Download column.

Appendix

This appendix contains instructions for using a host device's front panel controls to configure and operate an ATC-AUDIONET.

The ATC-AUDIONET is compatible with the following host devices:

- AES Adagio Entertainment System
- AMS Adagio Media System
- AMS-AIP Adagio Media System with Advanced Image Processing
- CEN-TRACK

CEN-TRACK

For instructions on using a CEN-TRACK to configure and control an ATC-AUDIONET, refer to the latest version of the CEN-TRACK Operations Guide (Doc. 6646) which is available for download from the Crestron Web site.

AES/AMS/AMS-AIP

The AES, AMS, and AMS-AIP support an ATC-AUDIONET when loaded with a SystemBuilder-created program that contains an ATC-AUDIONET.

For more information about configuring the AES, AMS, or AMS-AIP, refer to the respective Operations Guide.

NOTE: This section assumes an ATC-AUDIONET is installed in the AES, AMS, or AMS-AIP. Additionally, this section assumes that a program containing an ATC-AUDIONET was created and loaded on to the AES, AMS, or AMS-AIP.

NOTE: The AES, AMS, and AMS-AIP use the same procedures for configuring and operating an ATC-AUDIONET.

Configuration

The ATC-AUDIONET is configured using the Installer Tools function that is built in to the AES, AMS and AMS-AIP.

NOTE: Many of these options are already configured by the SystemBuilder-created program.

To use Installer Tools to configure the ATC-AUDIONET:

1. Press and hold the **ROOM** and **SOURCE** buttons for 10 seconds to open the Installer Tools menu.

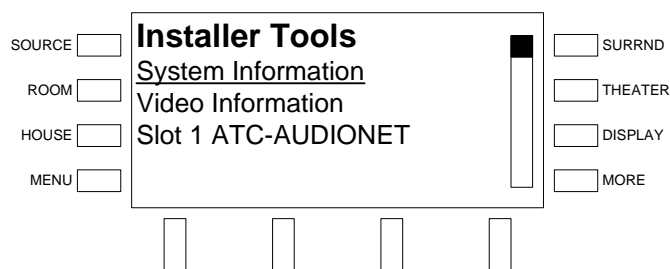
Installer Tools Menu

- Turn the selection knob to highlight the slot containing the ATC-AUDIONET (slot 1 in the previous diagram) and press the **ENTER** button. A list of parameters that can be viewed or changed are displayed.

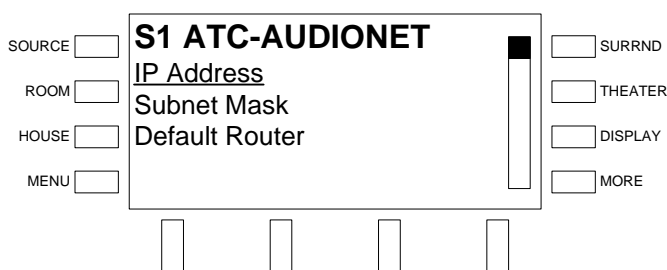
“ATC-AUDIONET” Controls**IP Address**

The ATC-AUDIONET uses TCP/IP communications for communications between a control system and a PC. The IP address can be manually set or obtained from a DHCP server. For information on enabling DHCP to obtain an IP address, refer to “Enable/Disable DHCP” on page 28. To manually set an IP address:

- Turn the selection knob to highlight **IP Address** and press the **ENTER** button. If DHCP is enabled, the IP address is displayed. Otherwise, the IP Address controls are displayed.

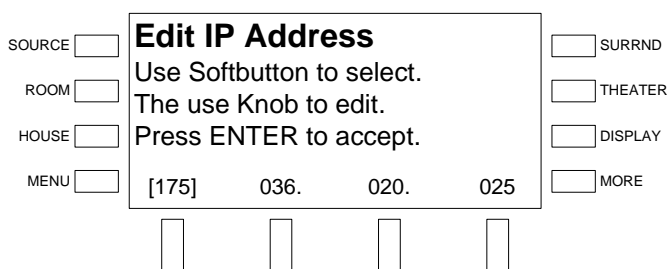
“Edit IP Address” Controls

- Turn the selection knob to set the first octet of the IP address.
- Press the soft button under the next octet (or press the **ENTER** button to move to the next octet) to select it for editing.
- Repeat steps 2 and 3 for each octet.
- To save the IP address, move the cursor to the right-most octet and press the **ENTER** button. To cancel the operation and return to the previous screen, press **MENU**.

Set the Subnet Mask

The subnet mask can be manually set or obtained from a DHCP server. For information on enabling DHCP to obtain a subnet mask, refer to “Enable/Disable DHCP” on page 28. To manually set the subnet mask:

1. Turn the selection knob to highlight **Subnet Mask** and press the **ENTER** button. If DHCP is enabled, the subnet mask is displayed. Otherwise, the subnet mask controls are displayed.

“Edit Subnet Mask” Controls

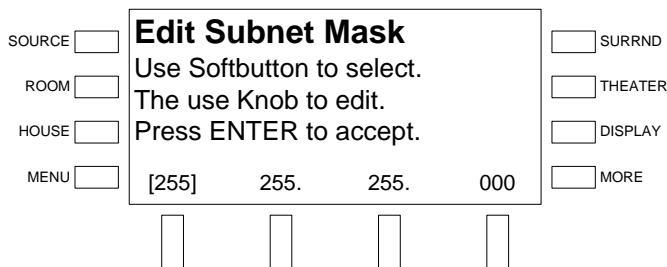

2. Turn the selection knob to set the first octet of the subnet mask.
3. Press the soft button under the next octet (or press the **ENTER** button to move to the next octet) to select it for editing.
4. Repeat steps 2 and 3 for each octet.
5. To save the subnet mask, move the cursor to the right-most octet and press the **ENTER** button. To cancel the operation and return to the previous screen, press **MENU**.

Set the Default Router

The default router can be manually set or obtained from a DHCP server. For information on enabling DHCP to obtain a default router, refer to “Enable/Disable DHCP” on page 28. To manually set the default router:

1. Turn the selection knob to highlight **Default Router** and press the **ENTER** button. If DHCP is enabled, the default router is displayed. Otherwise, the default router controls are displayed.

“Edit Default Router” Controls

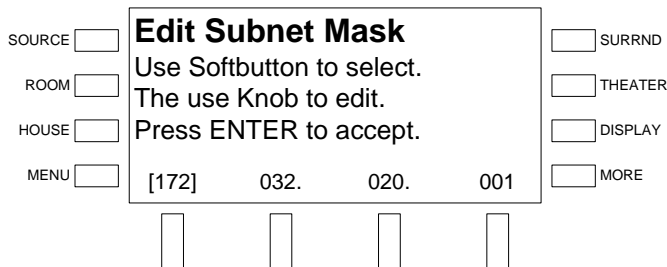

2. Turn the selection knob to set the first octet of the default router.
3. Press the soft button under the next octet (or press the **ENTER** button to move to the next octet) to select it for editing.
4. Repeat steps 2 and 3 for each octet.
5. To save the default router, move the cursor to the right-most octet and press the **ENTER** button. To cancel the operation and return to the previous screen, press **MENU**.

Enable/Disable DHCP

The ATC-AUDIONET can obtain an IP address, subnet mask, default router, and DNS server information from a DHCP server. To enable or disable DHCP:

1. Turn the selection knob to highlight **DHCP** and press the **ENTER** button. The DHCP controls are displayed.

“DHCP” Controls

SOURCE <input type="checkbox"/>	Edit DHCP * <u>Off</u> On	<input type="checkbox"/> SURRND
ROOM <input type="checkbox"/>		<input type="checkbox"/> THEATER
HOUSE <input type="checkbox"/>		<input type="checkbox"/> DISPLAY
MENU <input type="checkbox"/>		<input type="checkbox"/> MORE
		<input type="checkbox"/>
		<input type="checkbox"/>
		<input type="checkbox"/>
		<input type="checkbox"/>

The current setting is indicated with an asterisk (*).

2. Turn the selection knob to highlight the desired setting and press the **ENTER** button to select it. The display returns to the previous screen. To cancel the operation and return to the previous screen, press **MENU**.

View or Set the Hostname

The ATC-AUDIONET can be identified by a hostname instead on an IP address. To view or set the hostname:

1. Turn the selection knob to highlight **Hostname** and press the **ENTER** button. The hostname controls are displayed.

“Hostname” Controls

SOURCE <input type="checkbox"/>	Edit Hostname ATC-AUDIONET█	<input type="checkbox"/> SURRND		
ROOM <input type="checkbox"/>		<input type="checkbox"/> THEATER		
HOUSE <input type="checkbox"/>		<input type="checkbox"/> DISPLAY		
MENU <input type="checkbox"/>		<input type="checkbox"/> MORE		
	Del	<	>	Done
	<input type="checkbox"/>	<input type="checkbox"/>	<input type="checkbox"/>	<input type="checkbox"/>

2. Turn the selection knob clockwise or counterclockwise to select a new letter (uppercase or lowercase) or number and press the **ENTER** button. Move the cursor by pressing the soft buttons labeled < or >. The Hostname can be up to 64 characters in length. To delete a character, position the cursor under the character to be deleted and press the soft button labeled **Del**. To cancel the operation and return to the previous screen, press **MENU**.
3. Press the soft button labeled **Done** to save the hostname. To cancel the operation and return to the previous screen, press **MENU**.

Specify DNS Servers

The ATC-AUDIONET uses DNS servers to download internet radio artwork for display in a touch screen project. DNS servers should only be specified when using static IP addressing (DHCP disabled). To specify a DNS Server:

1. Turn the selection knob to highlight **DNS Servers** and press the **ENTER** button. The DNS servers controls are displayed.

“DNS Servers” Controls

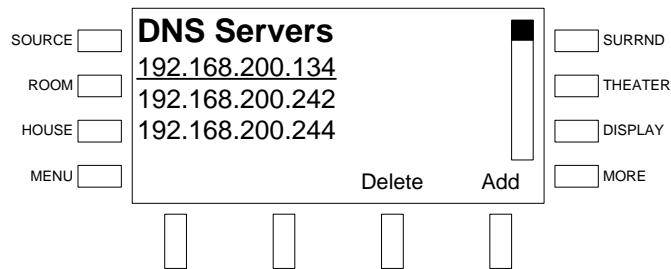

2. To delete an entry, turn the selection knob to the entry to be deleted and press the soft button labeled **Delete**.
3. To add an entry:
 - a. Press the soft button labeled **Add**.

“DNS Servers” Controls

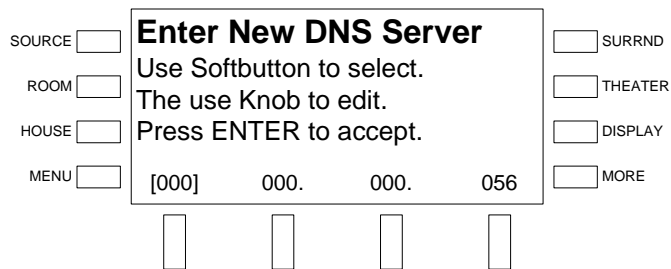

- b. Turn the selection knob to set the first octet of the DNS server.
 - c. Press the soft button under the next octet (or press the **ENTER** button to move to the next octet) to select it for editing.
 - d. Repeat steps b and c for each octet.
 - e. To save the DNS server address, move the cursor to the right-most octet and press the **ENTER** button. To cancel the operation and return to the previous screen, press **MENU**.
4. Press **MENU** to return to the previous screen.

View or Set IP ID

The ATC-AUDIONET is identified to a control system by an IP ID. For additional information on IP IDs, refer to “Ethernet Configuration” on page 7.

To set the IP ID:

1. Turn the selection knob to highlight **Control System IP ID** and press the **ENTER** button. The control system IP ID is displayed with the current IP ID.

“Control System IP ID” Controls

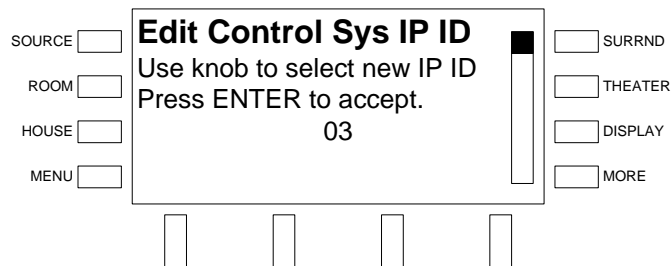

- Turn the selection knob to display the desired IP ID and press the **ENTER** button to select it. The display returns to the previous screen. To cancel the operation and return to the previous screen, press **MENU**.

Set Control System IP Address

The IP address of the master control system must be specified. To specify an IP address:

- Turn the selection knob to highlight **Control System IP Address** and press the **ENTER** button. The IP address controls are displayed.

“Edit Control System IP Address” Controls

SOURCE <input type="checkbox"/>	Edit Ctrl Sys IP Address	<input type="checkbox"/> SURRND
ROOM <input type="checkbox"/>	Use Softbutton to select.	<input type="checkbox"/> THEATER
HOUSE <input type="checkbox"/>	The use Knob to edit.	<input type="checkbox"/> DISPLAY
MENU <input type="checkbox"/>	Press ENTER to accept.	<input type="checkbox"/> MORE
	[172] 036. 021. 056	
	<input type="text"/> <input type="text"/> <input type="text"/> <input type="text"/>	

- Turn the selection knob to set the first octet of the IP address.
- Press the soft button under the next octet (or press the **ENTER** button to move to the next octet) to select it for editing.
- Repeat steps 2 and 3 for each octet.
- To save the IP address, move the cursor to the right-most octet and press the **ENTER** button. To cancel the operation and return to the previous screen, press **MENU**.

View MAC Address

To view the ATC-AUDIONET’s MAC address:

- Turn the selection knob to highlight **MAC Address** and press the **ENTER** button. The MAC address is displayed.
- Press **MENU** to return to the previous screen.

Operation

This section contains instructions for using the AES/AMS/AMS-AIP front panel to control an ATC-AUDIONET.

For more information about configuring the AES, AMS, or AMS-AIP, refer to the respective Operations Guide.

NOTE: To ensure proper operation, download and install the latest AES, AMS, or AMS-AIP firmware from <http://crestron.com/firmware>.

Select the ATC-AUDIONET

To select the Internet radio tuner:

- Press **SOURCE** and turn the selection knob until an Internet radio tuner is displayed.
- Press the **ENTER** button to select the tuner. If the tuner is already in use, its controls are displayed. Otherwise, press the soft button labeled **Control**.

Now Playing

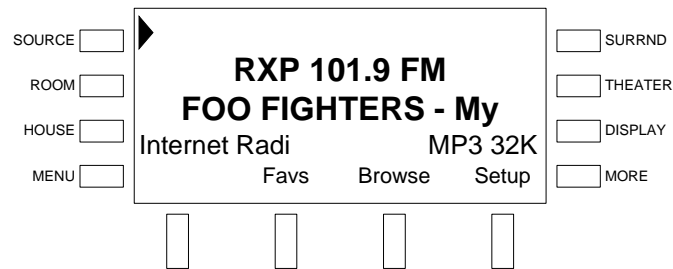

Tune a Station

To tune a station:

1. Press the soft button labeled **Browse**. A list of browsing options is displayed.

Browse Options

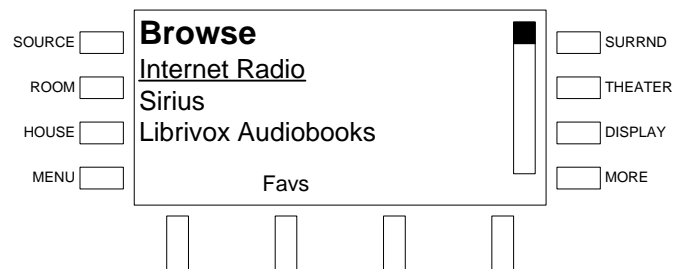

To return to the list of favorite stations, press the soft button labeled **Favs**.

2. Turn the selection knob to highlight an option and press the **ENTER** button. Choose the **Internet Radio** option to search for Internet radio stations and podcasts or browse through a selection of Internet radio stations and podcasts.

NOTE: To view a list of favorite stations and/or podcasts, press the soft button labeled **Favs**. For more information, refer to “Add Favorites” on page 33.

Internet Radio Options

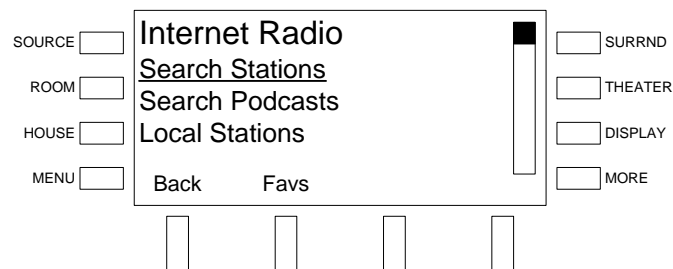

- **Search Stations/Search Podcasts:** To search for Internet radio stations or podcasts by name, turn the selection knob to either of these options and press the **ENTER** button.
 - a. To enter a search string, turn the selection knob to highlight a letter and press the **ENTER** button.

- b. To return to the previous screen, press the soft button labeled **Back**.
 - c. Repeat for each letter in the search string. To delete a character and move back a space, press the soft button labeled **Delete**. To insert a space and/or move the cursor forward, press the soft button labeled **>**.
 - d. Press the soft button labeled **Submit** to begin the search. A list of stations/podcasts matching the search string is displayed.
 - e. Turn the selection knob to browse through the search results.
 - f. Turn the selection knob to highlight the desired station/podcast and press the **ENTER** button to select.
- To browse stations that are geographically close to the ATC-AUDIONET, turn the selection knob to highlight **Local Stations** and press the **ENTER** button. The display lists stations that broadcast near the location of the ATC-AUDIONET.
 - a. Turn the selection knob to browse through the local stations.
 - b. Turn the selection knob to highlight the desired station and press the **ENTER** button to select.
 - To **browse** stations that were recently played, turn the selection knob to highlight **Recently Played** and press the **ENTER** button. The display lists stations that were recently played.
 - a. Turn the selection knob to browse through the recently played stations.
 - b. Turn the selection knob to highlight the desired station and press the **ENTER** button to select.
 - To **browse** stations or podcasts that broadcast from a specific geographic location, turn the selection knob to highlight **Location** or **Podcasts by Location** and press the **ENTER** button. The display lists geographic regions.
 - a. Use the selection knob and the **ENTER** button to select a geographic location (region, country, city, etc.).
 - b. Turn the selection knob to highlight the desired station or podcast and press the **ENTER** button to select.
 - To **browse** stations or podcasts by a specific genre, turn the selection knob to highlight **Genre** or **Podcasts by Genre** and press the **ENTER** button. The display lists available genre types.
 - a. Use the selection knob and the **ENTER** button to select a genre.
 - b. Turn the selection knob to highlight the desired station or podcast and press the **ENTER** button to select.
 - To browse newly added stations, turn the selection knob to highlight **New Stations** and press the **ENTER** button. The display lists stations that were recently added.
 - a. Turn the selection knob to browse through the newly added stations.
 - b. Turn the selection knob to highlight the desired station and press the **ENTER** button to select.

- To **browse** the most popular stations, turn the selection knob to highlight **Most Popular Stations** and press the **ENTER** button. The display lists the most popular stations.
 - a. Turn the selection knob to browse through the most popular stations.
 - b. Turn the selection knob to highlight the desired station and press the **ENTER** button to select.
- Favorite stations and podcasts can be managed online at radio.crestron.com. Use the **Get Access Code** option to create an account at radio.crestron.com. To obtain the access code:
 - a. Turn the selection knob to highlight **Get Access Code** and press the **ENTER** button. The access code is displayed.
 - b. Press the soft button labeled **Back** to return to the previous screen.
- **Favorite** stations and categories stored online at radio.crestron.com and on the Adagio system can be cleared from the Adagio system using the **Reset Favorites** option. To clear the list of favorite stations and categories:

NOTE: Resetting favorites will delete all favorite stations and categories from the Adagio system and from the online account at radio.crestron.com.

- a. Turn the selection knob to highlight **Reset Favorites** and press the **ENTER** button.
- b. To confirm the reset, turn the selection knob to highlight **Yes** and press the **ENTER** button. To cancel the reset, turn the selection knob to highlight **No** and press the **ENTER** button.

Choose the **Sirius** option to listen to the online feed from SiriusXM Satellite radio stations (subscription to online access required). To access the SiriusXM online feed:

- a. Turn the selection knob to highlight **Sirius** and press the **ENTER** button.
- b. Turn the selection knob to highlight the desired category or channel and press the **ENTER** button.
- c. Press the soft button labeled **Back** to return to the previous screen.

Choose the **Librivox Audiobooks** option to listen to free audiobooks from www.librivox.org. To select a file for listening:

- a. Turn the selection knob to highlight **Librivox Audiobooks** and press the **ENTER** button.
- b. Turn the selection knob to highlight the desired file and press the **ENTER** button.

*Add Favorites
(Internet Radio & SiriusXM
Only)*

Internet radio and SiriusXM stations can be added as favorites for quick recall. To make a station a “favorite”:

1. Tune an Internet radio station or SiriusXM station as described in “Tune a Station” on page 31. The station information is displayed.

Now Playing

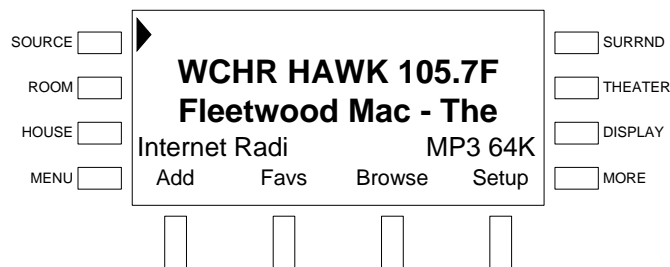

2. Press the soft button labeled **Add**.
3. Turn the selection knob to highlight the group where the favorite station is stored or highlight **Add New Group** to create a new favorite group.

Add New Group

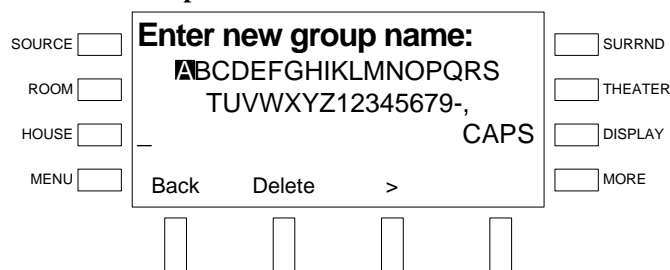

- a. Turn the selection knob to highlight a letter and press the **ENTER** button.
 - b. Repeat for each letter in the group. To delete a character and move back a space, press the soft button labeled **Delete**. To insert a space and/or move the cursor forward, press the soft button labeled **>**. To return to the previous screen, press the soft button labeled **Back**.
 - c. Press the soft button labeled **Submit** to enter the group name and save the station (skip step 4).
4. Press the **ENTER** button to save the favorite station.

NOTE: Favorite stations can also be saved online at radio.crestron.com. For more information, refer to “Manage Favorites” on page 20.

*Recall Favorites
(Internet Radio & SiriusXM
Only)*

Favorite stations can be recalled using the Adagio system’s front panel controls. To recall a favorite station:

1. Press the soft button labeled **Favs**. A list of station categories is displayed.

Favorite Categories

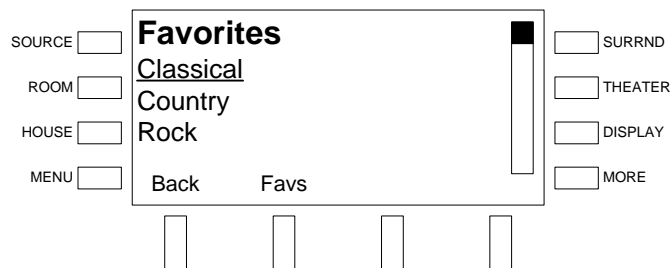

- Turn the selection knob to highlight the desired category and press the **ENTER** button.

Favorite Stations, Classical

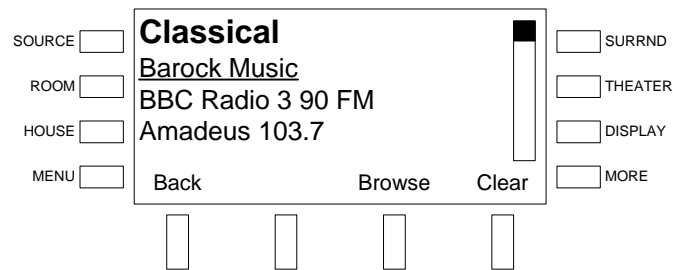

- Turn the selection knob to highlight the desired station and press the **ENTER** button.

Remove Favorites
(Internet Radio & SiriusXM Only)

A favorite station can be removed from the list of favorite stations using the Adagio system’s front panel controls.

NOTE: Stations that are cleared from the list of favorites are also cleared from the favorite station list at radio.crestron.com.

To remove a station from the list of favorites:

- Press the soft button labeled **Favs**. A list of station categories is displayed.

Favorite Categories

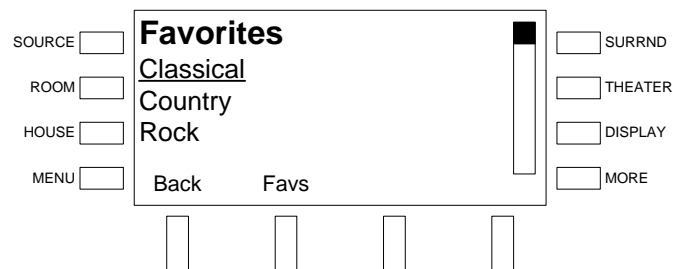

- Turn the selection knob to highlight the desired category and press the **ENTER** button.

Favorite Stations, Classical

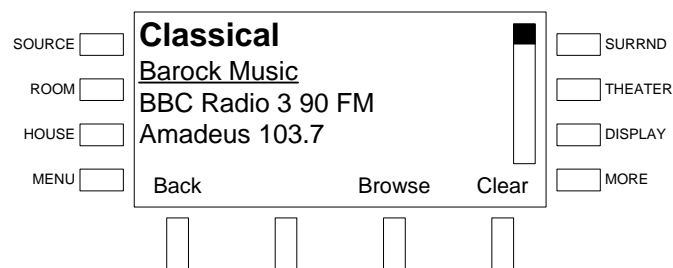

- Turn the selection knob to highlight the desired station and press the soft button labeled **Clear**.

Additional Setup

The front panel controls can also be used to setup SiriusXM, enable/disable providers, and provide secure access to the ATC-AUDIONET’s multimedia memory card (MMC).

To open the Setup tool:

1. Tune an Internet radio station as described in “Tune a Station” on page 31.
2. Press the soft button labeled **Setup** to open the Setup tool.

Setup Tool

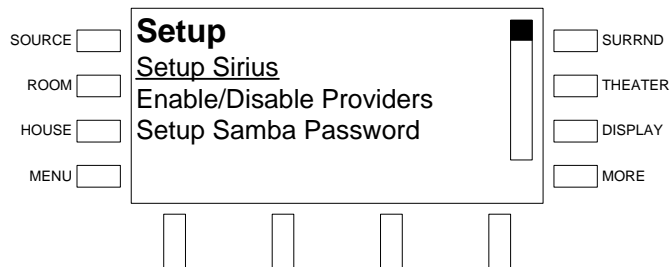

3. Turn the selection knob to highlight the parameter to configure and press the **ENTER** button.

To setup SiriusXM, turn the selection knob to highlight **Setup Sirius** and press the **ENTER** button.

NOTE: A paid subscription to online access is required. Free trial accounts are not supported.

Setup Sirius

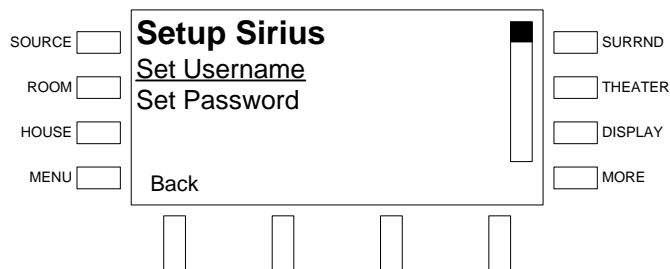

- a. If you do not already have a SiriusXM streaming account, go to www.sirius.com to set up an account.
- b. Turn the selection knob to highlight **Set Username** and press the **ENTER** button.
- c. Enter the username.

NOTE: The username is case-sensitive.

Enter Username



- i. Turn the selection knob to highlight a letter and press the **ENTER** button.
- ii. Repeat for each letter in the username. To delete a character and move back a space, press the soft button labeled **Delete**. To insert a space and/or move the cursor forward, press the soft button labeled **>**. To return to the previous screen, press the soft button labeled **Back**.
- iii. Press the soft button labeled **Submit** to enter the username.
- d. Enter the password.

NOTE: The password is case-sensitive.

Enter Password

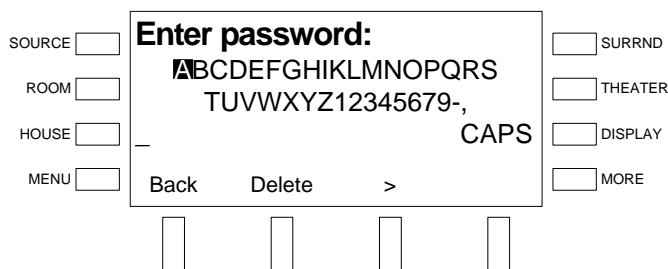

- i. Turn the selection knob to highlight a letter and press the **ENTER** button.
- ii. Repeat for each letter in the password. To delete a character and move back a space, press the soft button labeled **Delete**. To insert a space and/or move the cursor forward, press the soft button labeled **>**. To return to the previous screen, press the soft button labeled **Back**.
- iii. Press the soft button labeled **Submit** to enter the password.
- e. Press the soft button labeled **Back** to return to the previous screen.

Select **Enable/Disable Providers** to determine which services are displayed in the Browse menu. To enable/disable providers, turn the selection knob to highlight **Enable/Disable Providers** and press the **ENTER** button. A list of providers and their respective status is displayed.

Enable/Disable Providers

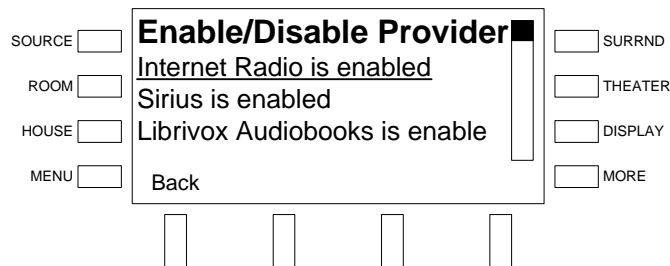

Enabled providers are displayed in the Browse menu while disabled providers are hidden in the Browse menu.

- a. Turn the selection knob to highlight the service to be enabled or disabled and press the **ENTER** button.

Provider Controls

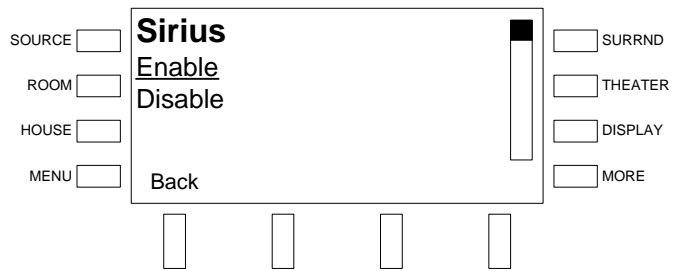

- b. Turn the selection knob to highlight the desired setting and press the **ENTER** button. To return to the previous screen, press the soft button labeled **Back**.
- c. Press the soft button labeled **Back** to return to the previous screen.

Use the **Setup Samba Password** option to create a password to secure access to the ATC-AUDIONET’s memory card. To setup the Samba password, turn the selection knob to highlight **Setup Samba Password** and press the **ENTER** button.

Enter Samba Password

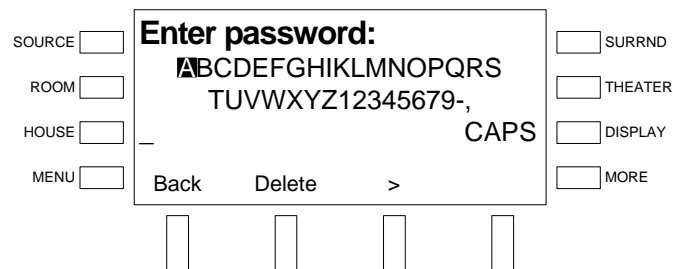

- a. Turn the selection knob to highlight a letter and press the **ENTER** button.
- b. Repeat for each letter in the password. To delete a character and move back a space, press the soft button labeled **Delete**. To insert a space and/or move the cursor forward, press the soft button labeled **>**. To return to the previous screen, press the soft button labeled **Back**.
- c. Press the soft button labeled **Submit** to enter the password.
- d. Press the soft button labeled **Back** to return to the previous screen.

GNU General Public License

Version 2, June 1991

Copyright (C) 1989, 1991 Free Software Foundation, Inc., 51 Franklin Street, Fifth Floor, Boston, MA 02110-1301 USA
Everyone is permitted to copy and distribute verbatim copies of this license document but changing it is not allowed.

PREAMBLE

The licenses for most software are designed to take away your freedom to share and change it. By contrast, the GNU General Public License is intended to guarantee your freedom to share and change free software--to make sure the software is free for all its users. This General Public License applies to most of the Free Software Foundation's software and to any other program whose authors commit to using it. (Some other Free Software Foundation software is covered by the GNU Lesser General Public License instead.) You can apply it to your programs too.

When we speak of free software, we are referring to freedom, not price. Our General Public Licenses are designed to make sure that you have the freedom to distribute copies of free software (and charge for this service if you wish), that you receive source code or can get it if you want it, that you can change the software or use pieces of it in new free programs and that you know you can do these things.

To protect your rights, we need to make restrictions that forbid anyone to deny you these rights or to ask you to surrender the rights. These restrictions translate to certain responsibilities for you if you distribute copies of the software or if you modify it.

For example, if you distribute copies of such a program, whether gratis or for a fee, you must give the recipients all the rights that you have. You must make sure that they too receive or can get the source code. And you must show them these terms so they know their rights.

We protect your rights with two steps: (1) copyright the software, and (2) offer you this license which gives you legal permission to copy, distribute and/or modify the software.

Also, for each author's protection and ours, we want to make certain that everyone understands that there is no warranty for this free software. If the software is modified by someone else and passed on, we want its recipients to know that what they have is not the original, so that any problems introduced by others will not reflect on the original authors' reputations.

Finally, any free program is threatened constantly by software patents. We wish to avoid the danger that redistributors of a free program will individually obtain patent licenses, in effect making the program proprietary. To prevent this, we have made it clear that any patent must be licensed for everyone's free use or not licensed at all.

The precise terms and conditions for copying, distribution and modification follow.

GNU GENERAL PUBLIC LICENSE TERMS AND CONDITIONS FOR COPYING, DISTRIBUTION AND MODIFICATION

0. This License applies to any program or other work which contains a notice placed by the copyright holder saying it may be distributed under the terms of this General Public License. The "Program" below refers to any such program or work, and a "work based on the Program" means either the Program or any derivative work under copyright law: that is to say, a work containing the Program or a portion of it, either verbatim or with modifications and/or translated into another language. (Hereinafter, translation is included without limitation in the term "modification".) Each licensee is addressed as "you".

Activities other than copying, distribution and modification are not covered by this License; they are outside its scope. The act of running the Program is not restricted, and the output from the Program is covered only if its contents constitute a work based on the Program (independent of having been made by running the Program). Whether that is true depends on what the Program does.

1. You may copy and distribute verbatim copies of the Program's source code as you receive it, in any medium, provided that you conspicuously and appropriately publish on each copy an appropriate copyright notice and disclaimer of warranty; keep intact all the notices that refer to this License and to the absence of any warranty; and give any other recipients of the Program a copy of this License along with the Program.

You may charge a fee for the physical act of transferring a copy and you may at your option offer warranty protection in exchange for a fee.

2. You may modify your copy or copies of the Program or any portion of it, thus forming a work based on the Program, and copy and distribute such modifications or work under the terms of Section 1 above, provided that you also meet all of these conditions:

- a) You must cause the modified files to carry prominent notices stating that you changed the files and the date of any change.
- b) You must cause any work that you distribute or publish, that in whole or in part contains or is derived from the Program or any part thereof, to be licensed as a whole at no charge to all third parties under the terms of this License.
- c) If the modified program normally reads commands interactively when run, you must cause it, when started running for such interactive use in the most ordinary way, to print or display an announcement including an appropriate copyright notice and a notice that there is no warranty (or else, saying that you provide a warranty) and that users may redistribute the program under these conditions, and telling the user how to view a copy of this License. (Exception: if the Program itself is interactive but does not normally print such an announcement, your work based on the Program is not required to print an announcement.)

These requirements apply to the modified work as a whole. If identifiable sections of that work are not derived from the Program and can be reasonably considered independent and separate works in themselves, then this License and its terms do not apply to those sections when you distribute them as separate works. But when you distribute the same sections as part of a whole which is a work based on the Program, the distribution of the whole must be on the terms of this License, whose permissions for other licensees extend to the entire whole and thus to each and every part regardless of who wrote it.

Thus, it is not the intent of this section to claim rights or contest your rights to work written entirely by you; rather, the intent is to exercise the right to control the distribution of derivative or collective works based on the Program.

In addition, mere aggregation of another work not based on the Program with the Program (or with a work based on the Program) on a volume of a storage or distribution medium does not bring the other work under the scope of this License.

3. You may copy and distribute the Program (or a work based on it, under Section 2) in object code or executable form under the terms of Sections 1 and 2 above provided that you also do one of the following:

- a) Accompany it with the complete corresponding machine-readable source code, which must be distributed under the terms of Sections 1 and 2 above on a medium customarily used for software interchange; or,
- b) Accompany it with a written offer, valid for at least three years, to give any third party, for a charge no more than your cost of physically performing source distribution, a complete machine-readable copy of the corresponding source code, to be distributed under the terms of Sections 1 and 2 above on a medium customarily used for software interchange; or,
- c) Accompany it with the information you received as to the offer to distribute corresponding source code. (This alternative is allowed only for noncommercial distribution and only if you received the program in object code or executable form with such an offer, in accord with Subsection b above.)

The source code for a work means the preferred form of the work for making modifications to it. For an executable work, complete source code means all the source code for all modules it contains, plus any associated interface definition files, plus the scripts used to control compilation and installation of the executable. However, as a special exception, the source code distributed need not include anything that is normally distributed (in either source or binary form) with the major components (compiler, kernel and so on) of the operating system on which the executable runs, unless that component itself accompanies the executable.

If distribution of executable or object code is made by offering access to copy from a designated place, then offering equivalent access to copy the source code from the same place counts as distribution of the source code, even though third parties are not compelled to copy the source along with the object code.

4. You may not copy, modify, sublicense or distribute the Program except as expressly provided under this License. Any attempt otherwise to copy, modify, sublicense or distribute the Program is void and will automatically terminate your rights under this License. However, parties who have received copies or rights, from you under this License will not have their licenses terminated so long as such parties remain in full compliance.

5. You are not required to accept this License, since you have not signed it. However, nothing else grants you permission to modify or distribute the Program or its derivative works. These actions are prohibited by law if you do not accept this License. Therefore, by

modifying or distributing the Program (or any work based on the Program), you indicate your acceptance of this License to do so and all its terms and conditions for copying, distributing or modifying the Program or works based on it.

6. Each time you redistribute the Program (or any work based on the Program), the recipient automatically receives a license from the original licensor to copy, distribute or modify the Program subject to these terms and conditions. You may not impose any further restrictions on the recipients' exercise of the rights granted herein. You are not responsible for enforcing compliance by third parties to this License.

7. If, as a consequence of a court judgment or allegation of patent infringement or for any other reason (not limited to patent issues), conditions are imposed on you (whether by court order, agreement or otherwise) that contradict the conditions of this License, they do not excuse you from the conditions of this License. If you cannot distribute so as to satisfy simultaneously your obligations under this License and any other pertinent obligations, then as a consequence you may not distribute the Program at all. For example, if a patent license would not permit royalty-free redistribution of the Program by all those who receive copies directly or indirectly through you, then the only way you could satisfy both it and this License would be to refrain entirely from distribution of the Program.

If any portion of this section is held invalid or unenforceable under any particular circumstance, the balance of the section is intended to apply and the section as a whole is intended to apply in other circumstances.

It is not the purpose of this section to induce you to infringe any patents or other property right claims or to contest validity of any such claims; this section has the sole purpose of protecting the integrity of the free software distribution system, which is implemented by public license practices. Many people have made generous contributions to the wide range of software distributed through that system in reliance on consistent application of that system; it is up to the author/donor to decide if he or she is willing to distribute software through any other system and a licensee cannot impose that choice.

This section is intended to make thoroughly clear what is believed to be a consequence of the rest of this License.

8. If the distribution and/or use of the Program is restricted in certain countries either by patents or by copyrighted interfaces, the original copyright holder who places the Program under this License may add an explicit geographical distribution limitation excluding those countries, so that distribution is permitted only in or among countries not thus excluded. In such case, this License incorporates the limitation as if written in the body of this License.

9. The Free Software Foundation may publish revised and/or new versions of the General Public License from time to time. Such new versions will be similar in spirit to the present version but may differ in detail to address new problems or concerns.

Each version is given a distinguishing version number. If the Program specifies a version number of this License which applies to it and "any later version", you have the option of following the terms and conditions either of that version or of any later version published by the Free Software Foundation. If the Program does not specify a version number of this License, you may choose any version ever published by the Free Software Foundation.

10. If you wish to incorporate parts of the Program into other free programs whose distribution conditions are different, write to the author to ask for permission. For software which is copyrighted by the Free Software Foundation, write to the Free Software Foundation; we sometimes make exceptions for this. Our decision will be guided by the two goals of preserving the free status of all derivatives of our free software and of promoting the sharing and reuse of software generally.

NO WARRANTY

11. BECAUSE THE PROGRAM IS LICENSED FREE OF CHARGE, THERE IS NO WARRANTY FOR THE PROGRAM, TO THE EXTENT PERMITTED BY APPLICABLE LAW. EXCEPT WHEN OTHERWISE STATED IN WRITING THE COPYRIGHT HOLDERS AND/OR OTHER PARTIES PROVIDE THE PROGRAM "AS IS" WITHOUT WARRANTY OF ANY KIND, EITHER EXPRESSED OR IMPLIED, INCLUDING BUT NOT LIMITED TO, THE IMPLIED WARRANTIES OF MERCHANTABILITY AND FITNESS FOR A PARTICULAR PURPOSE. THE ENTIRE RISK AS TO THE QUALITY AND PERFORMANCE OF THE PROGRAM IS WITH YOU. SHOULD THE PROGRAM PROVE DEFECTIVE, YOU ASSUME THE COST OF ALL NECESSARY SERVICING, REPAIR OR CORRECTION.

12. IN NO EVENT UNLESS REQUIRED BY APPLICABLE LAW OR AGREED TO IN WRITING WILL ANY COPYRIGHT HOLDER OR ANY OTHER PARTY WHO MAY MODIFY AND/OR REDISTRIBUTE THE PROGRAM AS PERMITTED ABOVE, BE LIABLE TO YOU FOR DAMAGES, INCLUDING ANY GENERAL, SPECIAL, INCIDENTAL OR CONSEQUENTIAL DAMAGES ARISING OUT OF THE USE OR INABILITY TO USE THE PROGRAM (INCLUDING BUT NOT LIMITED TO LOSS OF DATA OR DATA BEING RENDERED INACCURATE OR LOSSES SUSTAINED BY YOU OR THIRD PARTIES OR A FAILURE OF THE PROGRAM TO OPERATE WITH ANY OTHER PROGRAMS), EVEN IF SUCH HOLDER OR OTHER PARTY HAS BEEN ADVISED OF THE POSSIBILITY OF SUCH DAMAGES.

Return and Warranty Policies

Merchandise Returns / Repair Service

1. No merchandise may be returned for credit, exchange or service without prior authorization from CRESTRON. To obtain warranty service for CRESTRON products, contact an authorized CRESTRON dealer. Only authorized CRESTRON dealers may contact the factory and request an RMA (Return Merchandise Authorization) number. Enclose a note specifying the nature of the problem, name and phone number of contact person, RMA number and return address.
2. Products may be returned for credit, exchange or service with a CRESTRON Return Merchandise Authorization (RMA) number. Authorized returns must be shipped freight prepaid to CRESTRON, 6 Volvo Drive, Rockleigh, N.J. or its authorized subsidiaries, with RMA number clearly marked on the outside of all cartons. Shipments arriving freight collect or without an RMA number shall be subject to refusal. CRESTRON reserves the right in its sole and absolute discretion to charge a 15% restocking fee plus shipping costs on any products returned with an RMA.
3. Return freight charges following repair of items under warranty shall be paid by CRESTRON, shipping by standard ground carrier. In the event repairs are found to be non-warranty, return freight costs shall be paid by the purchaser.

CRESTRON Limited Warranty

CRESTRON ELECTRONICS, Inc. warrants its products to be free from manufacturing defects in materials and workmanship under normal use for a period of three (3) years from the date of purchase from CRESTRON, with the following exceptions: disk drives and any other moving or rotating mechanical parts, pan/tilt heads and power supplies are covered for a period of one (1) year; touch screen display and overlay components are covered for 90 days; batteries and incandescent lamps are not covered.

This warranty extends to products purchased directly from CRESTRON or an authorized CRESTRON dealer. Purchasers should inquire of the dealer regarding the nature and extent of the dealer's warranty, if any.

CRESTRON shall not be liable to honor the terms of this warranty if the product has been used in any application other than that for which it was intended or if it has been subjected to misuse, accidental damage, modification or improper installation procedures. Furthermore, this warranty does not cover any product that has had the serial number altered, defaced or removed.

This warranty shall be the sole and exclusive remedy to the original purchaser. In no event shall CRESTRON be liable for incidental or consequential damages of any kind (property or economic damages inclusive) arising from the sale or use of this equipment. CRESTRON is not liable for any claim made by a third party or made by the purchaser for a third party.

CRESTRON shall, at its option, repair or replace any product found defective, without charge for parts or labor. Repaired or replaced equipment and parts supplied under this warranty shall be covered only by the unexpired portion of the warranty.

Except as expressly set forth in this warranty, CRESTRON makes no other warranties, expressed or implied, nor authorizes any other party to offer any warranty, including any implied warranties of merchantability or fitness for a particular purpose. Any implied warranties that may be imposed by law are limited to the terms of this limited warranty. This warranty statement supersedes all previous warranties.

This page is intentionally left blank.



Crestron Electronics, Inc.
15 Volvo Drive Rockleigh, NJ 07647
Tel: 888.CRESTRON
Fax: 201.767.7576
www.crestron.com

**Operations & Installation Guide – DOC. 6933A
(2029249)**

10.11

Specifications subject to
change without notice.