



Description

The Crestron® DIN-1DIMU4 is a 4-channel, universal lighting control module designed to support dimming of both forward and reverse phase type loads. A single model supports both 120 and 220–240 volt electronic and magnetic low-voltage, incandescent, neon/cold cathode, 2-wire dimmable fluorescent, and non-dimmable lighting loads up to 5 amps per channel, 10 amps total.

Specifications for the DIN-1DIMU4 are listed in the following table.
 DIN-1DIMU4 Specifications

SPECIFICATION	DETAILS
Load Ratings	
Dimmer Channels	4
Maximum Per Channel	5 amps @ 120–240 volts ac, 50/60 Hz 600 watts @ 120 volts ac 1150 watts @ 230 volts ac 1200 watts @ 240 volts ac
Module Total	10 amps @ 120–240 volts ac, 50/60 Hz 1200 watts @ 120 volts ac 2300 watts @ 230 volts ac 2400 watts @ 240 volts ac
Load Types	Forward phase (leading edge) or reverse phase (trailing edge) electronic low-voltage, incandescent, neon/cold cathode, magnetic low-voltage, dimmable 2-wire fluorescent, and non-dim lighting
Input Voltage	
Line Power	120–240 volts ac, 50/60 Hz
Power Requirements	
Cresnet® Power Usage	0.6 watts (0.03 amps @ 24 volts dc) when line power is not available
Environmental	
Temperature	0°C to 40°C (32°F to 104°F)
Humidity	10% to 90% RH (noncondensing)
Heat Dissipation	60 Btu/h @ 240 volts with two channels @ 5 amps 50 Btu/h @ 120 volts with two channels @ 5 amps
Weight	912 g (32 oz)

Additional Resources

Visit the product page on the Crestron website (www.crestron.com) for additional information and the latest firmware updates. Use a QR reader application on your mobile device to scan the QR image.



Important Notes

WARNING: To avoid fire, shock, or death, turn off the power at the circuit breaker or fuse and test that the power is off before wiring!

CAUTION: This equipment is for indoor use only. Mount in a well ventilated area. The ambient temperature must be 32° to 104°F (0° to 40°C). The relative humidity must be 10% to 90% (noncondensing).

NOTES: Observe the following points.

- When installing in an enclosure, group high-voltage devices separately from low-voltage devices.
- Install and use this product in accordance with appropriate electrical codes and regulations.
- A qualified electrician should install this product.

WARNING: Prior to connecting the device, turn off power at the circuit breaker. Failure to do so may result in serious personal injury or damage to the device. Restore the power after all connections have been made.

CAUTION: Connecting this device to the wrong type of load or short-circuiting the load can cause severe product damage. Each load should be tested to identify a short-circuit condition prior to wiring the load to the module.

NOTE: Install in accordance with all local and national electric codes.

NOTE: High-voltage connections accept 12 AWG (2.5 mm²) wire. Wire should be stripped to 1/3 in (8 mm). Tighten terminal blocks to 5 in-lb (0.5 Nm).

NOTE: Use copper wire only. For high-voltage connections, use wire rated for at least 75°C.

NOTE: The DIN-1DIMU4 power feed must be protected by a 10 A (trip curve C) breaker or equivalent.

NOTE: The DIN-1DIMU4 outputs must be used for control of permanently installed lighting loads only.

NOTE: Do not mix magnetic and electronic transformers on the same dimmer output.

NOTE: Ensure the unit is properly grounded by connecting the chassis ground lug to an earth ground (building steel).

NOTE: To prevent overheating, do not operate this product in an area that exceeds the environmental temperature range listed in the table of specifications.

Installation

Install the DIN-1DIMU4.

1. Place the top of the DIN-1DIMU4's rail mount over the top of the DIN rail.
2. Tilt the bottom of the DIN-1DIMU4 toward the DIN rail until it snaps into place.

NOTE: When mounting DIN rail products, use a flat-head screwdriver to pull the DIN rail release tab while snapping the device onto the DIN rail.

To remove the DIN-1DIMU4 from the DIN rail, use a small, flat object (i.e., a flat-head screwdriver) to pull the DIN rail release, and tilt the bottom of the DIN-1DIMU4 away from the DIN rail.

NOTE: Certain third-party DIN cabinets provide space for an informational label between each DIN rail row. Crestron's Engraver software (version 4.0 or later) can generate appropriate labels for all Crestron DIN rail products.

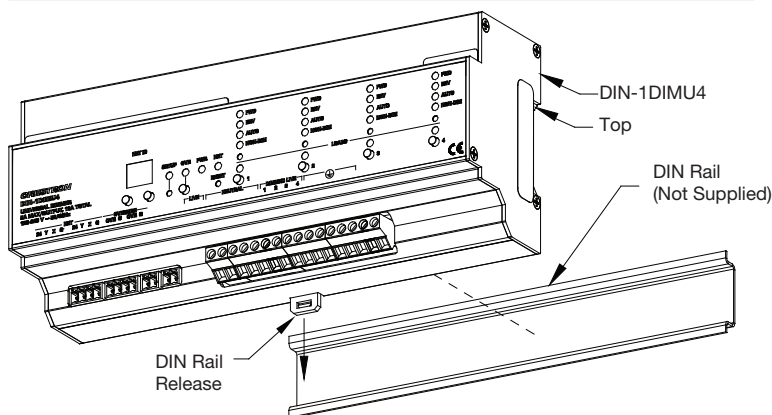

NOTE: To remove the DIN-1DIMU4 from the DIN rail, use a small, flat object (i.e., a flat-head screwdriver) to pull the DIN rail release and tilt the bottom of the DIN-1DIMU4 away from the DIN rail.

Hardware Hookup

Make the necessary connections. Apply power after all connections have been made. When making NET and OVERRIDE connections, strip the ends of the wires approximately 7/16 in (11 mm). Use care to avoid nicking the conductors. Tighten the connector to 5 in-lb (0.5 to 0.6 Nm). The wire gauge should be 14 to 26 AWG.

When making power connections to the DIN-1DIMU4, use a Crestron power supply.

Hardware Connections for the DIN-1DIMU4

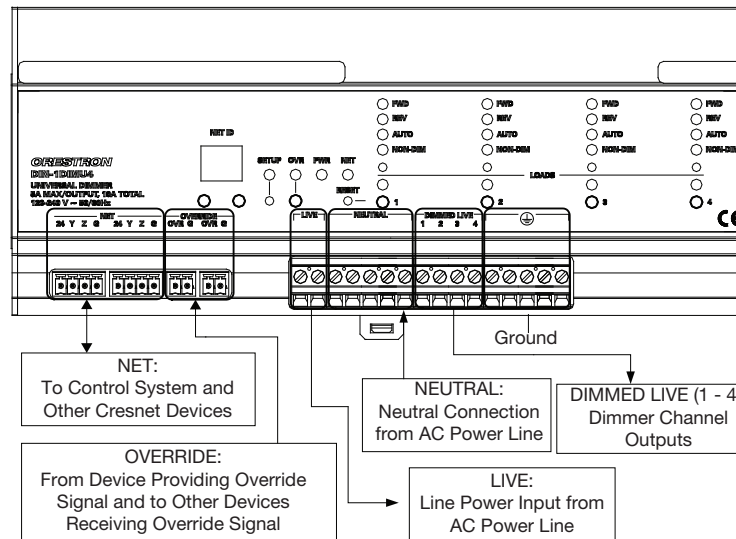

With the circuit breaker turned off, connect the wires to the terminal blocks per the markings provided on the DIN-1DIMU4. When making LIVE, NEUTRAL, DIMMED LIVE, and ground connections, strip the ends of the wires approximately 5/16 in (8 mm). Use care to avoid nicking the conductors. Tighten the connector to 4.5 in-lb (0.5 Nm). The wire gauge should be 10 to 24 AWG.

Load Connection Example for the DIN-1DIMU4

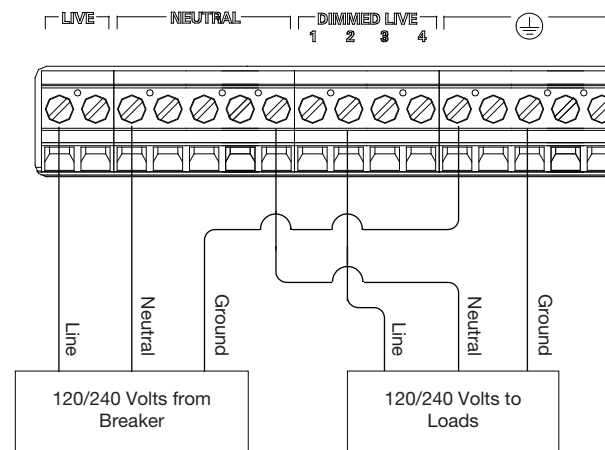

Set the Net ID

The Net ID of the DIN-1DIMU4 has been factory set to 86. The Net IDs of all devices in the same system must be unique. The Net ID can be changed from the front panel of the DIN-1DIMU4 or from a personal computer via Crestron Toolbox™.

Set the Net ID using the front panel.

1. Press the **SETUP** button to enter Setup mode. The SETUP LED illuminates.
2. Press the left and right buttons under the NET ID display to change the Net ID.

NOTE: The DIN-1DIMU4 will leave Setup mode after 10 seconds of inactivity and revert to the previously set Net ID.

3. When the desired Net ID is displayed, press the **SETUP** button to exit the Setup mode. The SETUP LED extinguishes.

NOTE: If an invalid Net ID is set (i.e., 00, 02, FF), "Er" will be displayed on the NET ID display, and the DIN-1DIMU4 will revert to the previously set Net ID.

A small Net ID label is provided on the DIN-1DIMU4 to document the unit's Net ID in the case where power is not available. Apply a mark over the digits that correspond to the assigned Net ID.

NET ID Label ("3C" Shown)



Operation

The DIN-1DIMU4 can be controlled via its front panel as well as from a control system. The following local controls are available.

Manual Load Control

The state of each output can be manually controlled from the front panel.

To toggle the output between off and on, tap the appropriate button (1 to 8). The corresponding LED illuminates, and the output state is shown on the NET ID display ("oF" for off, "On" for on) for two seconds after the button is released.

NOTE: The control system program may change the settings if Override mode is not enabled.

Establish Override Mode Levels

Override mode disables the control system program and sets all of the output states to the stored override values. The state of each output can be saved as an override setting, which can be automatically recalled when the Override mode is enabled.

NOTE: The control system program has a setting that can prevent locally saving the override state. If this setting is enabled, the display shows "Er" when the save override state is saved. For more information, refer to the SIMPL Windows help file.

To save the load level as an override setting, set all of the loads to either on or off and then press and hold the **OVR** button for three seconds. The OVR LED blinks to indicate the new override setting has been stored.

Toggle Override Mode

To enable Override mode, press the **OVR** button. The OVR LED flashes slowly. Override mode can also be toggled via a remote contact closure attached to the OVERRIDE port.

NOTE: If Override mode was enabled from an external device (i.e., a contact closure connected to the OVERRIDE port), the OVR LED will flash quickly when the local **OVR** button is pressed. Pressing the local **OVR** button has no effect when Override mode was toggled via the remote connection.

To disable Override mode, press the **OVR** button again. The OVR LED extinguishes, and the outputs return to the states set by the control system program.

NOTE: If override states have not been stored, the factory default override state is all loads on.

Reboot the DIN-1DIMU4

To reboot the DIN-1DIMU4, press the **RESET** button. The outputs will be set to the states currently specified by the control system program. If the control system does not provide any values, the outputs will be set to the previously set values.

Manual Operating Mode Selection

























If the DIN-1DIMU4 is operated without a Cresnet® connection to a control system, the operating mode must be set locally. The operating mode of the DIN-1DIMU4 is determined by load type that is connected. The dimmer's default operating mode is AUTO, which is appropriate for various types of loads. The output mode of the dimmer needs to be changed only when the connected device is not dimmable or is not being detected properly.

CAUTION: Setting the operating mode incorrectly may cause damage to the DIN-1DIMU4 or the lighting load.

Once a connection to a control system has been established, the program should define the unit as DIM or NON-DIM. The operating mode must still be selected locally on the dimmer.

NOTE: Once a program has been downloaded to the DIN-1DIMU4, manual selection of load types will be restricted. For example, if the program defines a channel as non-dim, it cannot be set to dim locally. Similarly, if the program defines a channel as dimmable, it cannot be set to non-dim locally. When the program defines a channel as dimmable, the operating mode is set to auto.

The operating mode is selected locally for each channel using the recessed Channel Mode Select push buttons. Press the recessed push button for the channels until the desired operating mode is selected for all channels. Refer to the following table for information about each operating mode and the corresponding unit display.

OPERATING MODE	UNIT DISPLAY
FWD-Channel operates as a dimmer using only forward phase (leading edge) dimming. The FWD LED illuminates when using forward phase dimming is selected. This mode is most suitable for magnetic transformers.	 FWD  REV  AUTO  NON-DIM 
REV-Channel operates as a dimmer using reverse phase (trailing edge) dimming. The REV LED illuminates when reverse phase dimming is selected. This mode is most suitable for electronic transformers, incandescent lamps, and the CLS-EXP Power Extender module (sold separately).	 FWD  REV  AUTO  NON-DIM 
AUTO-Channel operates as a dimmer and uses the built-in auto load detection to determine the most suitable dimming technology. The AUTO LED illuminates along with the REV or FWD LED to indicate the dimming technology that is being used. The REV LED lights when dimming electronic transformers or incandescent lamps. The FWD LED lights when dimming magnetic transformers.	 FWD  FWD  REV  REV  AUTO  AUTO  NON-DIM  NON-DIM  
NON-DIM-Channel operates only as a switch with no dimming capabilities. The NON-DIM LED illuminates when operating as a switch. When controlling non-dimmable fixtures, set the operating mode to NON-DIM.	 FWD  REV  AUTO  NON-DIM 

Troubleshooting

The following table provides corrective action for possible trouble situations. If further assistance is required, please contact a Crestron customer service representative.

DIN-1DIMU4 Troubleshooting

TROUBLE	POSSIBLE CAUSE(S)	CORRECTIVE ACTION
Device does not function.	DIN-1DIMU4 is not receiving power from the AC line or the Crestron power supply.	Ensure that the circuit breaker is not tripped.
	Device is not receiving power from a Crestron power source.	Use a Crestron power source. Verify connections.
	Device is not receiving sufficient power.	Use the Crestron Power Calculator to help calculate how much power is needed for the system.
	Electrostatic discharge due to improper grounding.	Check that all ground connections have been made properly.
PWR LED blinks.	DIN-1DIMU4 is not receiving power from the ac line.	Ensure that the circuit breaker is not tripped.
LOADS LED on a channel is blinking once per second.	Overcurrent protection has tripped.	Check the wiring on corresponding output for a short circuit. Check the total load on corresponding output for an overload.
LOADS LED on a channel is blinking twice per second.	The channel has been programmed to use reverse phase control (REV) but has detected a magnetic load connected.	Change programming to use AUTO or FWD.
LOADS LED on a channel is blinking three times per second.	The channel has overheated and shut down to protect itself.	Reduce loading on the channel. Reduce loading on the module. Improve enclosure ventilation to reduce ambient temperature.
Unit ignores Cresnet commands.	The unit is in Override mode.	Take out of Override mode by pressing OVR button or releasing override contact closure.
LOADS LED on a channel is constantly blinking fast. Light connected to dimmer intermittently flashes to full brightness.	The Electronic transformers connected are not suitable for dimming.	Disconnect the load to verify that the problem disappears.
		Replace the transformers.
LOADS LED on a channel is constantly blinking fast. Light connected to dimmer stays on full brightness.	The unit has a permanent fault.	Add a minimum 10-watt incandescent lamp in parallel with the transformers.
		Disconnect the load to verify that the problem persists.
		Leave the load disconnected, or connect to another channel
		Contact Crestron for support.
The load flickers, flashes, or slowly varies in light level when running on generator or UPS power.	There is unstable frequency due to generator or UPS power.	Using Crestron Toolbox, disable the Wilson filter. NOTE: Disabling the Wilson filter may leave the dimmer susceptible to other forms of line noise creating flicker.

This product is Listed to applicable UL Standards and requirements by Underwriters Laboratories Inc.



As of the date of manufacture, the SortName has been tested and found to comply with specifications for CE marking.



Federal Communications Commission (FCC) Compliance Statement

This device complies with part 15 of the FCC Rules. Operation is subject to the following conditions:(1) This device may not cause harmful interference and (2) this device must accept any interference received, including interference that may cause undesired operation.

CAUTION: Changes or modifications not expressly approved by the manufacturer responsible for compliance could void the user's authority to operate the equipment.

NOTE: This equipment has been tested and found to comply with the limits for a Class B digital device, pursuant to part 15 of the FCC Rules. These limits are designed to provide reasonable protection against harmful interference in a residential installation. This equipment generates, uses

and can radiate radio frequency energy and, if not installed and used in accordance with the instructions, may cause harmful interference to radio communications. However, there is no guarantee that interference will not occur in a particular installation. If this equipment does cause harmful interference to radio or television reception, which can be determined by turning the equipment off and on, the user is encouraged to try to correct the interference by one or more of the following measures:

- Reorient or relocate the receiving antenna.
- Increase the separation between the equipment and receiver.
- Connect the equipment into an outlet on a circuit different from that to which the receiver is connected.
- Consult the dealer or an experienced radio/TV technician for help.

Industry Canada (IC) Compliance Statement

This Class B digital apparatus complies with Canadian ICES-003.

Cet appareil numérique de la classe B est conforme à la norme NMB-003 du Canada.

The product warranty can be found at www.crestron.com/warranty.

The specific patents that cover Crestron products are listed at patents.crestron.com.

Certain Crestron products contain open source software. For specific information, please visit www.crestron.com/opensource.

Crestron, the Crestron logo, Cresnet, and Crestron Toolbox are either trademarks or registered trademarks of Crestron Electronics, Inc. in the United States and/or other countries. UL and the UL logo are either trademarks or registered trademarks of Underwriters Laboratories, Inc. in the United States and/or other countries. Other trademarks, registered trademarks, and trade names may be used in this document to refer to either the entities claiming the marks and names or their products. Crestron disclaims any proprietary interest in the marks and names of others. Crestron is not responsible for errors in typography or photography.

This document was written by the Technical Publications department at Crestron.

©2015 Crestron Electronics, Inc.

Crestron Electronics, Inc.

15 Volvo Drive Rockleigh, NJ 07647
Tel: 888.CRESTRON
Fax: 201.767.7576
www.crestron.com

Installation & Operation Guide - DOC. 6668E

(2020750)

11.15

Specifications subject to change without notice.