

Crestron DM-TX-200-C-2G-FLOOR/
DM-TX-200-C-2G-WALL

DigitalMedia 8G+™ Transmitter 200

Operations & Installation Guide



This document was prepared and written by the Technical Documentation department at:



Crestron Electronics, Inc.
15 Volvo Drive
Rockleigh, NJ 07647
1-888-CRESTRON

Regulatory Compliance

As of the date of manufacture, the DM-TX-200-C-2G-FLOOR and DM-TX-200-C-2G-WALL have been tested and found to comply with specifications for CE marking and standards per EMC and Radiocommunications Compliance Labelling.



Federal Communications Commission (FCC) Compliance Statement

This device complies with part 15 of the FCC Rules. Operation is subject to the following conditions:

(1) This device may not cause harmful interference and (2) this device must accept any interference received, including interference that may cause undesired operation.

CAUTION: Changes or modifications not expressly approved by the manufacturer responsible for compliance could void the user's authority to operate the equipment.

NOTE: This equipment has been tested and found to comply with the limits for a Class A digital device, pursuant to part 15 of the FCC Rules. These limits are designed to provide reasonable protection against harmful interference when the equipment is operated in a commercial environment. This equipment generates, uses and can radiate radio frequency energy and, if not installed and used in accordance with the instruction manual, may cause harmful interference to radio communications. Operation of this equipment in a residential area is likely to cause harmful interference in which case the user will be required to correct the interference at his own expense.

Industry Canada (IC) Compliance Statement

This Class A digital apparatus complies with Canadian ICES-003.

Cet appareil numérique de la classe A est conforme à la norme NMB-003 du Canada.

This device includes an aggregation of separate independent works that are each generally copyrighted by Crestron Electronics, Inc., with all rights reserved. One of those independent works, Linux Bridge Project, is copyrighted under the GNU GENERAL PUBLIC LICENSE, Version 2, reproduced in "GNU General Public License" on page 33, where the corresponding source code is available at: <ftp://ftp.crestron.com/gpl>.

Crestron, the Crestron logo, Crestron Toolbox, DigitalMedia, DigitalMedia 8G, DigitalMedia 8G+, DM, DM 8G, DM 8G+, and QuickSwitch HD are trademarks or registered trademarks of Crestron Electronics, Inc. in the United States and other countries. Dolby Digital and the double-D symbol are either trademarks or registered trademarks of Dolby Laboratories in the United States and/or other countries. DTS and the DTS logos and Symbol are either trademarks or registered trademarks of DTS, Inc. in the United States and/or other countries. HDMI and the HDMI logo are trademarks or registered trademarks of HDMI Licensing LLC in the United States and/or other countries. Windows is a registered trademark of Microsoft Corporation in the United States and/or other countries. Other trademarks, registered trademarks, and trade names may be used in this document to refer to either the entities claiming the marks and names or their products. Crestron disclaims any proprietary interest in the marks and names of others.

©2011 Crestron Electronics, Inc.

Contents

DigitalMedia 8G+™ Transmitter 200: DM-TX-200-C-2G-FLOOR/DM-TX-200-C-2G-WALL	1
Introduction	1
Features and Functions	1
Application	4
Specifications	5
Physical Description	9
Setup	18
Network Wiring	18
Identity Code	18
Installation	19
Hardware Hookup	21
Programming Software	23
Earliest Version Software Requirements for the PC	23
Programming with SIMPL Windows	23
Uploading and Upgrading	26
Establishing Communication	26
Firmware	28
IP Configuration	29
DMTool	29
Problem Solving	30
Troubleshooting	30
Reference Documents	31
Further Inquiries	31
Future Updates	31
Return and Warranty Policies	32
Merchandise Returns / Repair Service	32
CRESTRON Limited Warranty	32
GNU General Public License	33

DigitalMedia 8G+™ Transmitter 200: DM-TX-200-C-2G-FLOOR/ DM-TX-200-C-2G-WALL

Introduction

The DM-TX-200-C-2G-FLOOR/DM-TX-200-C-2G-WALL is a DM 8G+™ transmitter and switcher that provides a convenient interface for computers and high-definition AV sources as part of a complete DigitalMedia™ system. The DM-TX-200-C-2G-FLOOR/DM-TX-200-C-2G-WALL connects to the head end or display location using a single CAT5e or Crestron® DM 8G® cable.

The DM-TX-200-C-2G-FLOOR installs in a floor box (not included) or in an open, ventilated area (for example, under a table). With both HDMI® and RGB inputs, the DM-TX-200-C-2G-FLOOR is ideal for floor box applications in a boardroom, classroom, or auditorium to provide an input for a laptop computer or similar source.

The DM-TX-200-C-2G-WALL installs in a 2-gang electrical box (not included) in an insulated wall, floor, or ceiling. With both HDMI and RGB inputs, the DM-TX-200-C-2G-WALL is ideal for wall and lectern applications in a boardroom, classroom, or residence to provide an input for a laptop computer or similar source.

NOTE: Throughout the remainder of this guide, the DM-TX-200-C-2G-FLOOR and DM-TX-200-C-2G-WALL are referred to simply as the *DM-TX-200-C-2G* unless otherwise noted.

Features and Functions

- DigitalMedia 8G+ transmitter and multimedia interface
- Built-in 2x1 AV switcher
- DM 8G+ output supports up to 330 foot (100 meter) cable length*
- Designed for installation in a 6 inch (153 mm) floor box (not included) or in an open, ventilated area (DM-TX-200-C-2G-FLOOR only)
- Designed for installation in a 2-gang electrical box (not included) (DM-TX-200-C-2G-WALL only)

(Continued on following page)

* For DM 8G+ wiring up to 330 feet (100 meters) between devices, use Crestron DM-CBL-8G DigitalMedia 8G™ cable, Crestron DM-CBL DigitalMedia cable, Crestron DM-CBL-D DigitalMedia D cable, or generic CAT5e (or better) UTP or STP. Shielded cable and connectors are recommended to safeguard against unpredictable environmental electrical noise which may impact performance at resolutions above 1080p. Refer to the latest version of the Crestron DigitalMedia Infrastructure Guide (Doc. 4556) for complete wiring guidelines and to the Crestron DigitalMedia Design Guide (Doc. 4789) for complete system design guidelines. The manuals are available from the Crestron Web site at www.crestron.com/dmresources. All cable sold separately.

Features and Functions

(Continued)

- White and black metallic faceplate insets included (DM-TX-200-C-2G-WALL only)
- Provides HDMI and RGB/component video inputs¹
- Supports DVI and DisplayPort Multimode sources²
- Includes mini-TRS stereo audio input
- Provides onboard auto-switching capability
- Includes USB HID (human interface device) keyboard/mouse port
- Powered over the DM[®] connection or local power pack (included)³
- Affords a true one-wire connection to a DM switcher or receiver (each sold separately)
- Detects and reports detailed video and audio input information
- Performs automatic AV signal format management via EDID
- Enables device control via CEC
- Allows quick, easy setup and diagnostics
- Extends the life of analog-based AV systems

DigitalMedia 8G+

DigitalMedia 8G+™ provides a true one-wire transport for moving high-definition video, audio, and Ethernet over low-cost twisted pair cable without compression or repeaters. Just one eight-conductor twisted pair cable is required, supporting distances up to 330 feet (100 meters) using Crestron DM 8G cable or CAT5e.⁴

DigitalMedia thoughtfully manages all of the various AV signals and devices in your system, matching each source's output to the capabilities of the selected display(s). Every signal is preserved in its native video resolution and audio format, ensuring a pure, lossless signal path throughout.

Multimedia Computer/AV Interface

The DM-TX-200-C-2G provides simple switching between two inputs. Its HDMI input supports HDCP and handles WUXGA computer resolutions and 1080p60 HDTV with multi-channel lossless audio. The HDMI input can also handle DVI and DisplayPort Multimode signals using an appropriate adapter or dongle². The RGB input handles all analog RGB and VGA signals up to WUXGA 1920x1200 pixels, as well as analog video up to 1080p60¹. A mini-TRS stereo audio input is also provided to accept analog audio signals from an unbalanced line level or headphone output.

1. The RGB input can accept component, composite, and S-video signals via direct interface to Crestron MPS Series products, or through an appropriate adapter (not included). Input sync detection is not provided for composite or S-video signal types through the RGB connection.
2. HDMI requires an appropriate adapter or interface cable to accommodate a DVI or DisplayPort Multimode signal. CBL-HD-DVI interface cable sold separately.
3. Power over DM (PoDM) requires connection to a DM 8G+ PoDM power sourcing device.
4. For DM 8G+ wiring up to 330 feet (100 meters) between devices, use Crestron DM-CBL-8G DigitalMedia 8G cable, Crestron DM-CBL DigitalMedia cable, Crestron DM-CBL-D DigitalMedia D cable, or generic CAT5e (or better) UTP or STP. Shielded cable and connectors are recommended to safeguard against unpredictable environmental electrical noise which may impact performance at resolutions above 1080p. Refer to the latest version of the Crestron DigitalMedia Infrastructure Guide (Doc. 4556) for complete wiring guidelines and to the Crestron DigitalMedia Design Guide (Doc. 4789) for complete system design guidelines. All cable sold separately.

A single cable connects the DM-TX-200-C-2G to a DM switcher or receiver, transporting video, audio, control, networking, and power signals all through one simple RJ-45 connection^{1, 2}. Used with a single DM 8G+ receiver/room controller and optional Crestron control system, the DM-TX-200-C-2G affords a simple solution for extending a multimedia computer or AV signal to a single display up to 330 feet (100 meters) away¹. As part of a larger system using a DM switcher, multiple DM-TX-200-C-2Gs may be installed to enable the distribution of several sources at different locations to feed multiple displays throughout any room or larger facility.

Keyboard/Mouse Extender

The DM-TX-200-C-2G also functions as a keyboard/mouse extender, allowing a USB HID-compliant keyboard and/or mouse at the floor box location (DM-TX-200-C-2G-FLOOR) or electrical box location (DM-TX-200-C-2G-WALL) to control a computer or other host device located at the central equipment rack or some other location.

EDID Format Management

The DM-TX-200-C-2G allows for management of the EDID (Extended Display Identification Data) information that passes between the display devices and input sources in the system. Using Crestron Toolbox™ software, the format and resolution capabilities of each device can be assessed and managed through the DM-TX-200-C-2G, ensuring reliable operation by instructing sources to output only the resolutions and formats that can be handled by the displays and system wiring.

CEC Embedded Device Control

The primary objective of every Crestron system is to enable precisely the control desired for a seamless user experience. DigitalMedia provides an alternative to conventional IR and RS-232 device control by harnessing the CEC (Consumer Electronics Control) signal embedded in HDMI. Through its connection to the control system, the DM-TX-200-C-2G provides a gateway for controlling the connected source device through the HDMI connection, potentially eliminating the need for any dedicated control wires or IR probes. Through proper CEC signal management, DigitalMedia allows you to take control of each device in the system as you like.

1. For DM 8G+ wiring up to 330 feet (100 meters) between devices, use Crestron DM-CBL-8G DigitalMedia 8G cable, Crestron DM-CBL DigitalMedia cable, Crestron DM-CBL-D DigitalMedia D cable, or generic CAT5e (or better) UTP or STP. Shielded cable and connectors are recommended to safeguard against unpredictable environmental electrical noise which may impact performance at resolutions above 1080p. Refer to the latest version of the Crestron DigitalMedia Infrastructure Guide (Doc. 4556) for complete wiring guidelines and to the Crestron DigitalMedia Design Guide (Doc. 4789) for complete system design guidelines. All cable sold separately.
2. Power over DM (PoDM) requires connection to a DM 8G+ PoDM power sourcing device.

Floor Box/Electrical Box Mount Design

The DM-TX-200-C-2G-FLOOR is designed to fit a 2-gang opening in a 6 inch (153 mm) deep floor box. The DM-TX-200-C-2G-WALL is designed to be mounted in a 2-gang electrical box (not included), and features an integral metal faceplate.

A DM cable connects to the rear of the DM-TX-200-C-2G via a shielded RJ-45 DM port. The unit can be powered using the included wall mount power pack or via Power over DM (PoDM) for a true one-wire solution.* An array of indicators on the front of the DM-TX-200-C-2G provides for easy setup and troubleshooting. Advanced configuration is enabled through Crestron Toolbox software.

* PoDM requires connection to a DM 8G+ PoDM power sourcing device.

Application

The following diagram shows a DM-TX-200-C-2G in a standalone application. In this type of application, the DM-TX-200-C-2G is used with a DM 8G+ receiver/room controller such as the DM-RMC-100-C and is not used with a DM switcher.

DM-TX-200-C-2G in a Standalone Application (DM-TX-200-C-2G-FLOOR Shown)

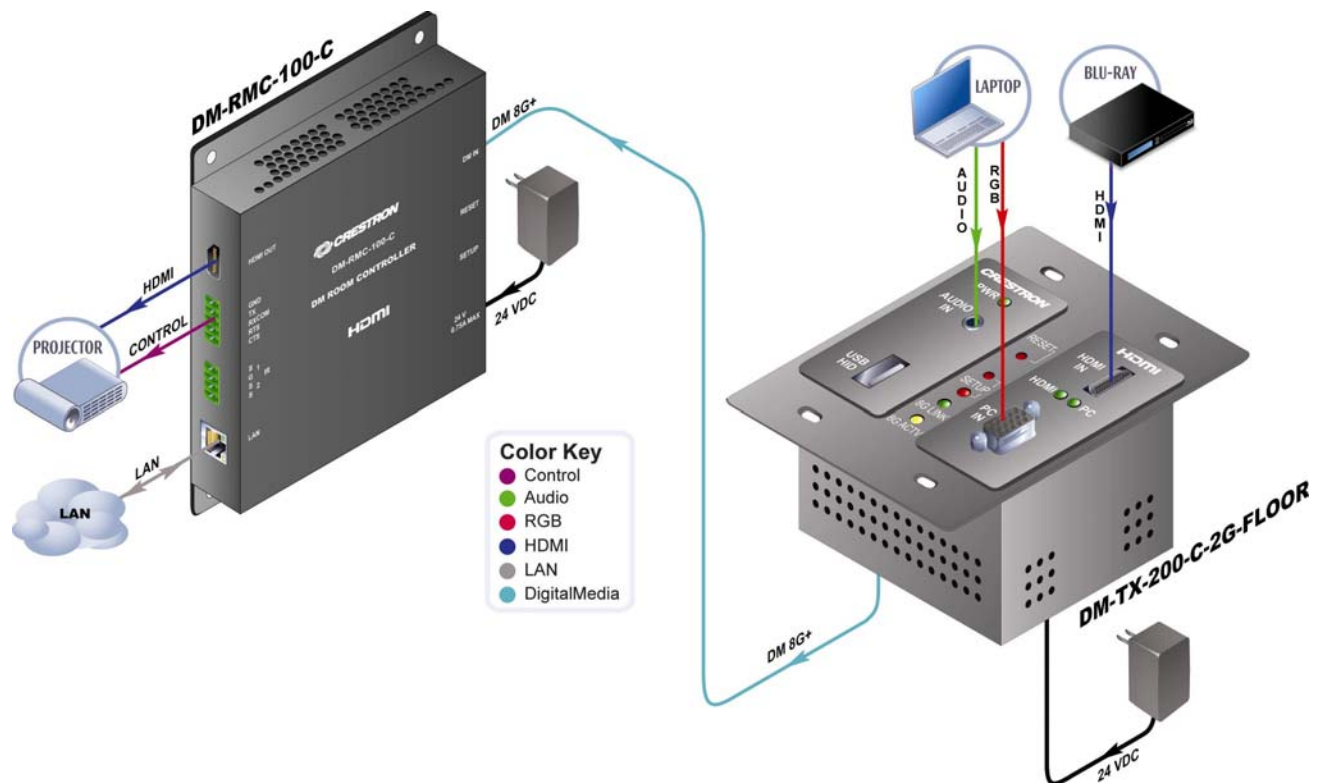

Specifications

Specifications for the DM-TX-200-C-2G are listed in the following table.

DM-TX-200-C-2G Specifications

SPECIFICATION	DETAILS
Video	
Switcher	2x1 combination digital/analog switch, Crestron QuickSwitch HD®
Input Signal Types	HDMI, DVI ¹ , DisplayPort Multimode ¹ , RGB, component (YPbPr) ² , S-video (Y/C) ² , composite ²
Output Signal Type	DM 8G+ (DigitalMedia over one CAT5e twisted pair copper wire) ³
Formats	HDMI, DVI, HDCP content protection support, computer up to UXGA/WUXGA, HDTV up to 1080p60, NTSC or PAL
Input Resolutions	
HDMI & DVI, Progressive	640 x 480 @ 60 Hz 720 x 480 @ 60 Hz (480p) 720 x 576 @ 50 Hz (576p) 800 x 600 @ 60 Hz 848 x 480 @ 60 Hz 852 x 480 @ 60 Hz 854 x 480 @ 60 Hz 1024 x 768 @ 60 Hz 1024 x 852 @ 60 Hz 1024 x 1024 @ 60 Hz 1280 x 720 @ 50 Hz (720p50) 1280 x 720 @ 60 Hz (720p60) 1280 x 768 @ 60 Hz 1280 x 800 @ 60 Hz 1280 x 960 @ 60 Hz 1280 x 1024 @ 60 Hz 1360 x 768 @ 60 Hz 1365 x 1024 @ 60 Hz 1366 x 768 @ 60 Hz 1400 x 1050 @ 60 Hz 1440 x 900 @ 60 Hz 1600 x 900 @ 60 Hz 1600 x 1200 @ 60 Hz 1680 x 1050 @ 60 Hz 1920 x 1080 @ 24 Hz (1080p24) 1920 x 1080 @ 25 Hz (1080p25) 1920 x 1080 @ 50 Hz (1080p50) 1920 x 1080 @ 60 Hz (1080p60) 1920 x 1200 @ 60 Hz 2048 x 1080 @ 24 Hz 2048 x 1152 @ 60 Hz plus any other resolution allowed by HDMI up to 165 MHz pixel clock

(Continued on following page)

DM-TX-200-C-2G Specifications (Continued)

SPECIFICATION	DETAILS
Video	
Input Resolutions (Continued)	
HDMI & DVI, Interlaced	720 x 480 @ 30 Hz (480i) 720 x 576 @ 25 Hz (576i) 1920 x 1080 @ 25 Hz (1080i25) 1920 x 1080 @ 30 Hz (1080i30) plus any other resolution allowed by HDMI up to 165 MHz pixel clock
RGB	640 x 480 @ 60 Hz 720 x 480 @ 60 Hz (480p) 720 x 576 @ 50 Hz (576p) 800 x 600 @ 60 Hz 848 x 480 @ 60 Hz 1024 x 768 @ 60 Hz 1280 x 720 @ 50 Hz (720p50) 1280 x 720 @ 60 Hz (720p60) 1280 x 768 @ 60 Hz 1280 x 800 @ 60 Hz 1280 x 960 @ 60 Hz 1280 x 1024 @ 60 Hz 1360 x 768 @ 60 Hz 1366 x 768 @ 60 Hz 1400 x 1050 @ 60 Hz 1440 x 900 @ 60 Hz 1600 x 1200 @ 60 Hz 1680 x 1050 @ 60 Hz 1920 x 1080 @ 50 Hz (1080p50) 1920 x 1080 @ 60 Hz (1080p60) 1920 x 1200 @ 60 Hz 2048 x 1152 @ 60 Hz
Component ²	480i 576i 480p 576p 720p50 720p60 1080p24 1080i25 (1125 lines) 1080i30 1080p30 1080p50 (1125 lines) 1080p60
Composite and S-video ²	480i 576i
Output Resolutions	Matched to inputs
Analog-To-Digital Conversion	10-bit 165 MHz per each of 3 channels

(Continued on following page)

DM-TX-200-C-2G Specifications (Continued)

SPECIFICATION	DETAILS
Audio	
Switcher	2x1 combination digital/analog switch
Input Signal Types	HDMI, DisplayPort Multimode ¹ , analog stereo
Output Signal Type	DM 8G+
Formats	
HDMI	Dolby Digital®, Dolby Digital EX, DTS®, DTS-ES, DTS 96/24, Up to 8ch PCM
Analog	Stereo 2-channel
Analog-To-Digital Conversion	24-bit 48 kHz
Performance (Analog)	
Frequency Response	20 Hz to 20 kHz ±0.75 dB
S/N Ratio	>90 dB, 20 Hz to 20 kHz A-weighted
THD+N	<0.05% @ 1 kHz
Stereo Separation	>90 dB
Communications	
DigitalMedia	DM 8G+, HDCP management, EDID format management, CEC, PoDM
USB	Supports USB HID class devices
Power Requirements ⁴	
Power Pack	0.75 Amps @ 24 Volts DC; 100-240 Volts AC, 50/60 Hz power pack included
PoDM	Receives power from a DM 8G+ PoDM power sourcing device
Minimum 2-Series Control System Update File ^{5, 6}	Version 4.003.0029 or later
Environmental	
Temperature	DM-TX-200-C-2G-FLOOR: 32° to 81° F (0° to 27° C) DM-TX-200-C-2G-WALL: 32° to 95° F (0° to 35° C)
Humidity	10% to 90% RH (non-condensing)
Heat Dissipation	43 BTU/Hr

(Continued on following page)

DM-TX-200-C-2G Specifications (Continued)

SPECIFICATION	DETAILS
Enclosure	
Construction	DM-TX-200-C-2G-FLOOR: Metal with black finish DM-TX-200-C-2G-WALL: Metal chassis with black metal faceplate, includes black and white metal inset covers
Mounting	DM-TX-200-C-2G-FLOOR: 2-gang mountable in a typical 6 inch (153 mm) deep floor box, 2.5 inch (64 mm) minimum mounting depth required DM-TX-200-C-2G-WALL: 2-gang mountable in a standard electrical box (2.5 inch [64 mm] deep minimum)
Dimensions	
Height	DM-TX-200-C-2G-FLOOR: 4.12 in (105 mm) DM-TX-200-C-2G-WALL: 4.70 in (120 mm)
Width	DM-TX-200-C-2G-FLOOR: 3.50 in (89 mm) DM-TX-200-C-2G-WALL: 4.70 in (120 mm)
Depth	2.65 in (68 mm)
Weight	DM-TX-200-C-2G-FLOOR: 15 oz (400 g) DM-TX-200-C-2G-WALL: 19 oz (526 g)
Included Accessory	24 VDC Wall Mount Power Pack, Universal
Available Accessories	
CBL-AUDIO	Crestron Certified Mini-TRS Stereo Audio Interface Cable
CBL-HD	Crestron Certified HDMI Interface Cable
CBL-HD-DVI	Crestron Certified HDMI to DVI Interface Cable
CBL-VGA	Crestron Certified Computer VGA Interface Cable
CBL-VGA-AUD	Crestron Certified Computer VGA Interface Cable with Mini-TRS Audio
DM-8G-CONN-100	DigitalMedia 8G™ Cable Connectors
DM-CBL-8G	DigitalMedia 8G Cable

- HDMI requires an appropriate adapter or interface cable to accommodate a DVI or DisplayPort Multimode signal. CBL-HD-DVI interface cable sold separately.
- The RGB input can accept component, composite, and S-video signals via direct interface to Crestron MPS Series products, or through an appropriate adapter (not included). Input sync detection is not provided for composite or S-video signal types through the RGB connection.

3. For DM 8G+ wiring up to 330 feet (100 meters) between devices, use Crestron DM-CBL-8G DigitalMedia 8G cable, Crestron DM-CBL DigitalMedia cable, Crestron DM-CBL-D DigitalMedia D cable, or generic CAT5e (or better) UTP or STP. Shielded cable and connectors are recommended to safeguard against unpredictable environmental electrical noise which may impact performance at resolutions above 1080p. Refer to the latest version of the Crestron DigitalMedia Infrastructure Guide (Doc. 4556) for complete wiring guidelines and to the Crestron DigitalMedia Design Guide (Doc. 4789) for complete system design guidelines. All cable sold separately.
4. Either a power pack or PoDM—but not both—can be used to power the DM-TX-200-C-2G.
5. The latest software versions can be obtained from the Crestron Web site. Refer to the NOTE following these footnotes.
6. Crestron 2-Series control systems include the AV2 and PRO2. Consult the latest Crestron Product Catalog for a complete list of 2-Series control systems.

NOTE: Crestron software and any files on the Web site are for authorized Crestron dealers and Crestron Authorized Independent Programmers (CAIP) only. New users may be required to register to obtain access to certain areas of the site (including the FTP site).

Physical Description

This section provides information on the connections, controls and indicators available on your DM-TX-200-C-2G.

DM-TX-200-C-2G-FLOOR Physical Views (Front and Rear)



DM-TX-200-C-2G-WALL Physical Views (Front with and without Faceplate)



DM-TX-200-C-2G-WALL Physical View (Rear)



DM-TX-200-C-2G-FLOOR Overall Dimensions (Top, Front, and Side Views)

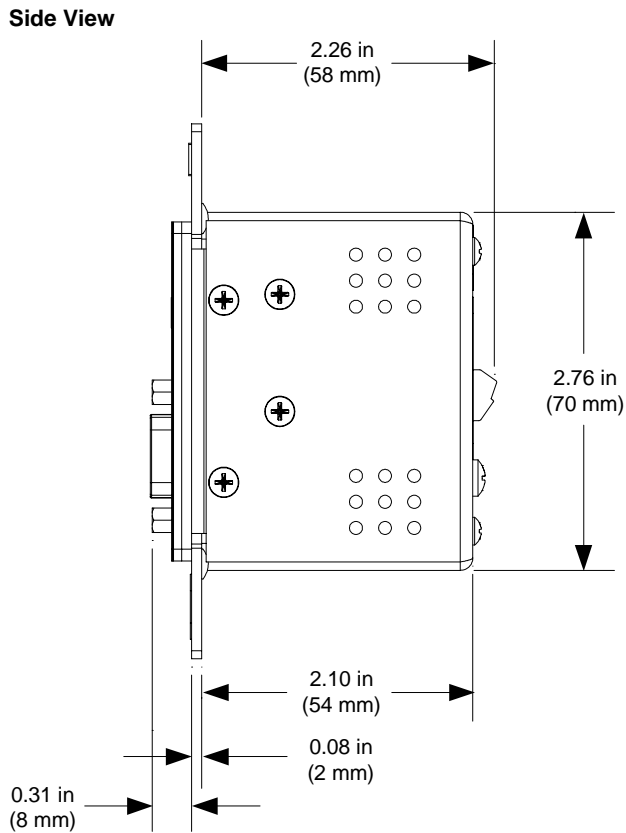
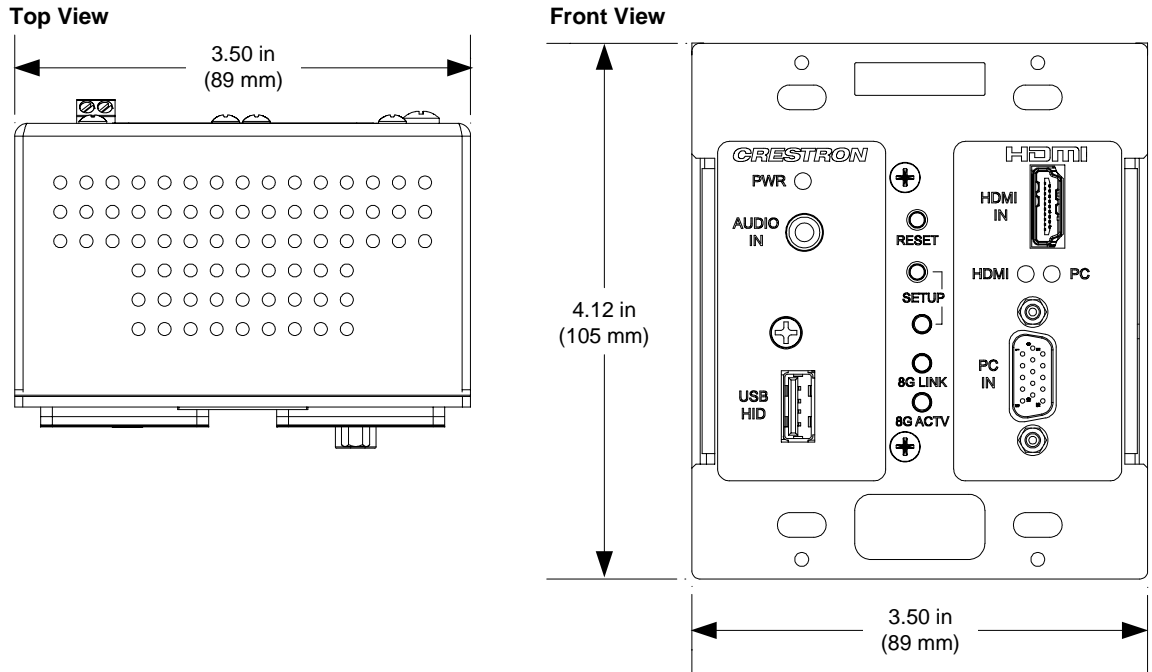

DM-TX-200-C-2G-WALL Overall Dimensions (Top, Front, and Side Views)

Top View

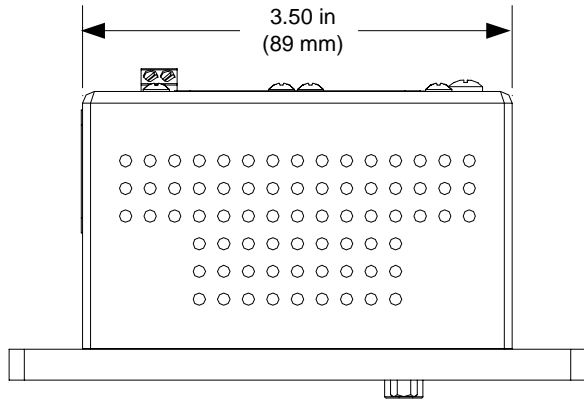

Front View (Shown with Faceplate)

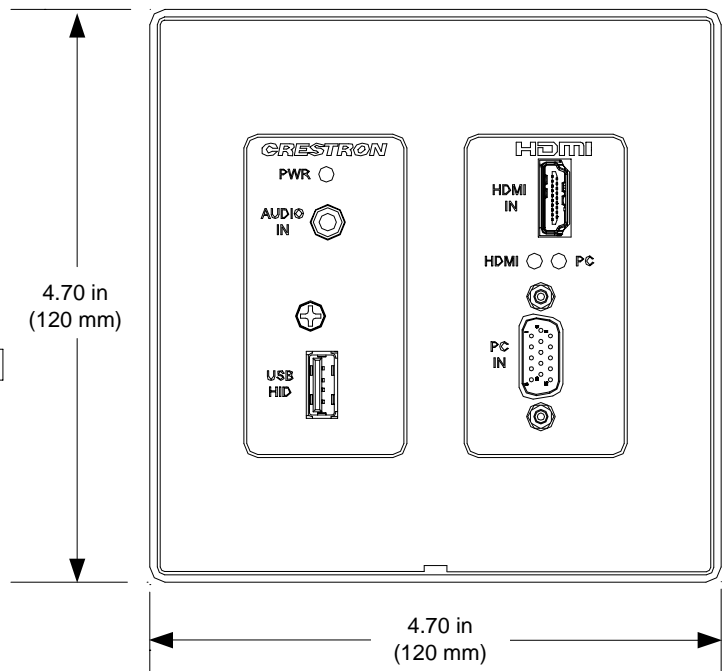

Side View

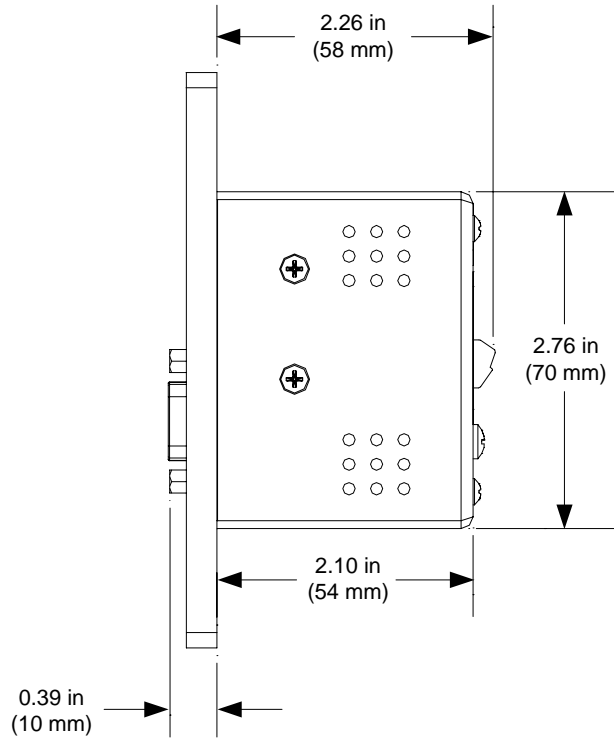

DM-TX-200-C-2G-FLOOR Connectors, Controls & Indicators (Front and Rear Views)

Front View

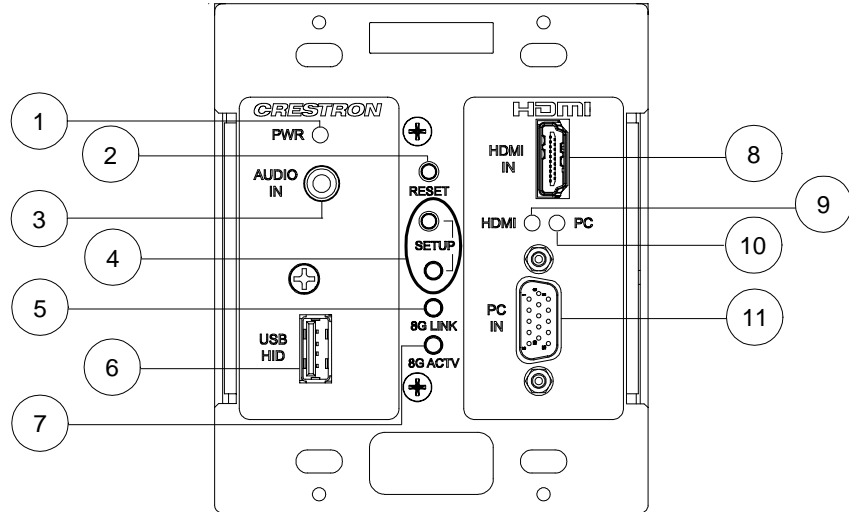

Rear View

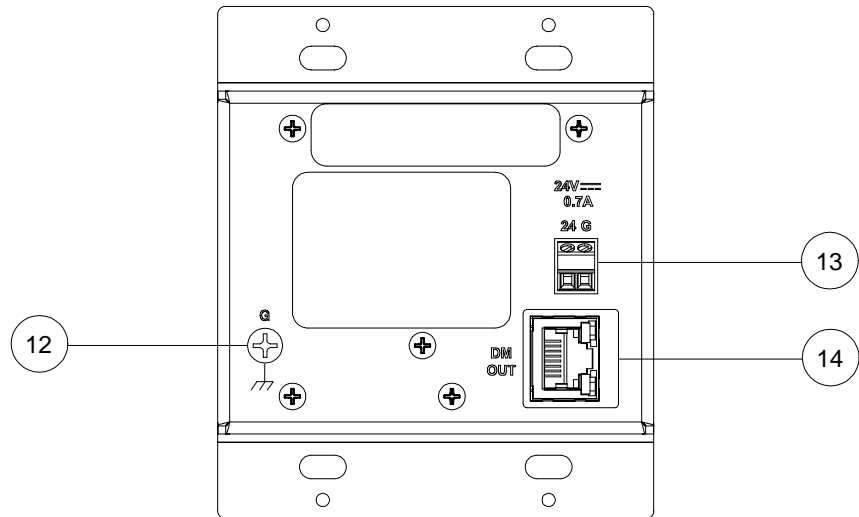

DM-TX-200-C-2G-WALL Connectors, Controls & Indicators (Front and Rear Views)



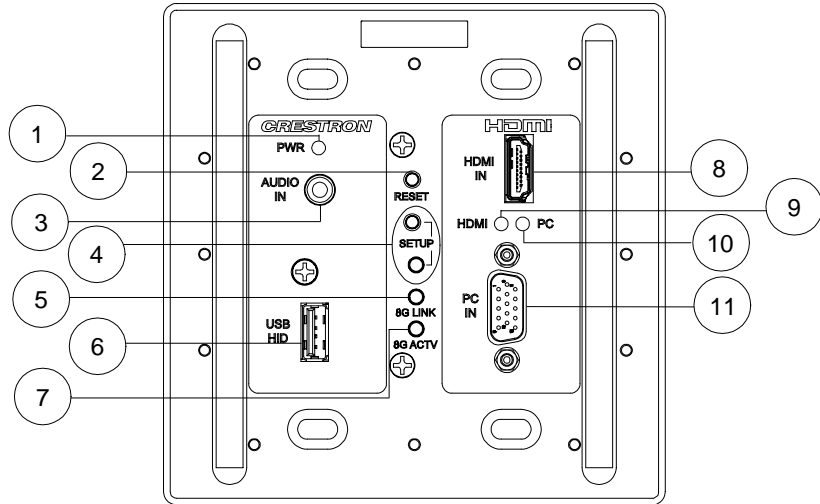

Front View (Shown without Faceplate)

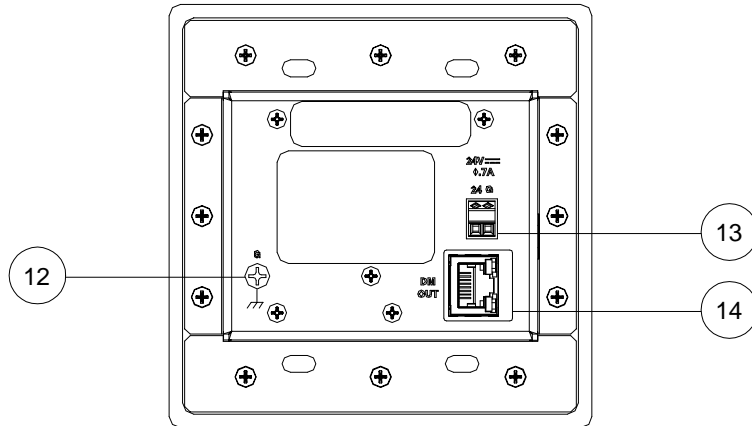

Rear View

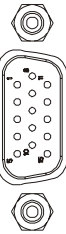

Connectors, Controls & Indicators

#	CONNECTORS, CONTROLS & INDICATORS	DESCRIPTION
1	PWR LED	(1) Green LED, indicates operating power supplied via PoDM or power pack
2	RESET	(1) Miniature recessed push button for hardware reset
3	AUDIO IN 	(1) 3.5 mm TRS mini phone jack; Unbalanced stereo line level audio input; Input Impedance: 10k Ohms; Input Level: 2 V _{rms} maximum
4	SETUP (Button and LED)	(1) Miniature recessed push button for Ethernet auto-discovery and (1) red LED
5	8G LINK LED	(1) Green LED, indicates DM link status
6	USB HID 	(1) USB Type A female; USB 2.0 host port for connection of a mouse/keyboard or other USB HID-compliant device
7	8G ACTV LED	(1) Yellow LED; Solid yellow LED indicates HDCP video; Blinking yellow LED indicates non-HDCP video
8	HDMI IN 	(1) 19-pin Type A HDMI female; HDMI digital video/audio input; Also supports DVI and DisplayPort Multimode ¹
9	HDMI LED	(1) Green LED, indicates HDMI input is selected
10	PC LED	(1) Green LED, indicates PC input is selected
11	PC IN 	(1) DB15HD female; RGB (VGA), component, S-video, or composite video input ^{2, 3} ; Formats: RGBHV, RGBS, RG _s B, YP _b P _r , Y/C, NTSC, PAL; Input Levels: 0.5 to 1.5 V _{p-p} with built-in DC restoration; Input Impedance: 75 Ohms; Sync Input Type: Autodetect RGBHV, RGBS, RG _s B, YP _b P _r ; Sync Input Level: 3 to 5 V _{p-p} ; Sync Input Impedance: 1k Ohms
12	G 	(1) 6-32 screw, chassis ground lug

(Continued on following page)

Connectors, Controls & Indicators (Continued)

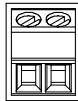
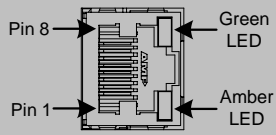
#	CONNECTORS, CONTROLS & INDICATORS	DESCRIPTION
13	<p>24V --- 0.7A 24 G</p> 	(1) 2-pin captive screw terminal block; 24 VDC power input; Power pack included
14	<p>DM OUT^{4, 5}</p> 	(1) 8-pin RJ-45 female, shielded, with two LED indicators; DM 8G+ output, accepts PoDM ⁶ ; Connects to DM 8G+ input of a DM switcher, receiver/room controller, or other DM device via CAT5e or Crestron DM-CBL-8G cable ⁷ ; Green LED indicates DM link status; Solid amber LED indicates HDCP video; Blinking amber LED indicates non-HDCP video

1. HDMI requires an appropriate adapter or interface cable to accommodate a DVI or DisplayPort Multimode signal. CBL-HD-DVI interface cable sold separately.
2. The RGB input can accept component, composite, and S-video signals via direct interface to Crestron MPS Series products, or through an appropriate adapter (not included). Input sync detection is not provided for composite or S-video signal types through the RGB connection.
3. Refer to the following table for the **PC IN** connector pinouts.

PC IN Connector Pinouts

PIN #	RGB	YP _b P _r	S-VIDEO	COMPOSITE
1	R	P _r	C	
2	G	Y	Y	
3	B	P _b		Comp
13	H			
14	V			

4. To determine which is pin 1 on the cable, hold the cable so the end of the eight pin modular jack is facing away from you, with the clip down and copper side up. Pin 1 is on the far left.

- The **DM OUT** port consists of one RJ-45 connector. The connector is recessed to accommodate long male cable connectors. Refer to the following table for the connector pinouts.

DM OUT Connector Pinouts

			
PIN #	WIRE COLOR	PIN #	WIRE COLOR
1	Orange/White	5	Blue/White
2	Orange	6	Green
3	Green/White	7	Brown/White
4	Blue	8	Brown

- PoDM requires connection to a DM 8G+ PoDM power sourcing device.
- For DM 8G+ wiring up to 330 feet (100 meters) between devices, use Crestron DM-CBL-8G DigitalMedia 8G cable, Crestron DM-CBL DigitalMedia cable, Crestron DM-CBL-D DigitalMedia D cable, or generic CAT5e (or better) UTP or STP. Shielded cable and connectors are recommended to safeguard against unpredictable environmental electrical noise which may impact performance at resolutions above 1080p. Refer to the latest version of the Crestron DigitalMedia Infrastructure Guide (Doc. 4556) for complete wiring guidelines and to the Crestron DigitalMedia Design Guide (Doc. 4789) for complete system design guidelines. All cable sold separately.

Setup

Network Wiring

When wiring the DM network, consider the following:

- Use Crestron Certified Wire.
- Use Crestron power supplies for Crestron equipment.

CAUTION: Failure to use Crestron power supplies could cause equipment damage or void the Crestron warranty.

- Provide sufficient power to the system.
- For DM 8G+ wiring up to 330 feet (100 meters) between devices, use Crestron DM-CBL-8G DigitalMedia 8G cable, Crestron DM-CBL DigitalMedia cable, Crestron DM-CBL-D DigitalMedia D cable, or generic CAT5e (or better) UTP or STP. Shielded cable and connectors are recommended to safeguard against unpredictable environmental electrical noise which may impact performance at resolutions above 1080p. Refer to the latest version of the Crestron DigitalMedia Infrastructure Guide (Doc. 4556) for complete wiring guidelines and to the Crestron DigitalMedia Design Guide (Doc. 4789) for complete system design guidelines. The manuals are available from the Crestron Web site (www.crestron.com/dmresources).

The DM-TX-200-C-2G also uses high-speed Ethernet for communications between the device and a control system, computer, media server, and other IP-based devices. For information specifically related to Ethernet connectivity using DigitalMedia devices, refer to the latest version of the Crestron IP Considerations Guide for the IT Professional (Doc. 4579), which is available from the Crestron Web site (www.crestron.com/dmresources).

Identity Code

NOTE: In the SIMPL Windows program, the IP ID of the DM-TX-200-C-2G is assigned automatically and does not require additional programming when the DM-TX-200-C-2G is dropped onto an input card of a DM switcher. Use the information below when a DM-TX-200-C-2G is dropped directly into an Ethernet slot on the control system in SIMPL Windows without a DM switcher.

The IP ID is set within the IP table of the DM-TX-200-C-2G using Crestron Toolbox. For information on setting an IP table, refer to the Crestron Toolbox help file. The IP IDs of multiple DM-TX-200-C-2Gs in the same system must be unique.

When setting the IP ID, consider the following:

- The IP ID of each unit must match an IP ID specified in the SIMPL Windows program.
- Each device using IP to communicate with a control system must have a unique IP ID.

Installation

To prevent overheating, do not operate the DM-TX-200-C-2G in an area that exceeds the environmental temperature range listed in the table of specifications.

DM-TX-200-C-2G-FLOOR Installation

The DM-TX-200-C-2G-FLOOR is designed to fit a 2-gang opening in a 6 inch (153 mm) deep floor box (not included). A minimum mounting depth of 2.5 inches (64 mm) is required. The DM-TX-200-C-2G-FLOOR can also be installed in an open, ventilated area (for example, under a table).

NOTE: Do not install the DM-TX-200-C-2G-FLOOR in an insulated floor, wall, or ceiling. For those applications, use the DM-TX-200-C-2G-WALL.

NOTE: Before installing the DM-TX-200-C-2G-FLOOR in a floor box, verify that the required wiring has been fed through the floor box. Connect the wiring to the rear of the DM-TX-200-C-2G-FLOOR (refer to “Hardware Hookup” which starts on page 21 for information about connections to the rear of the DM-TX-200-C-2G-FLOOR).

Using a Phillips head or straight blade screwdriver, attach the DM-TX-200-C-2G-FLOOR to the floor box using the four included #6-32 x 3/4” truss combo head screws (2009211) as illustrated below.

DM-TX-200-C-2G-FLOOR Installation in a Floor Box

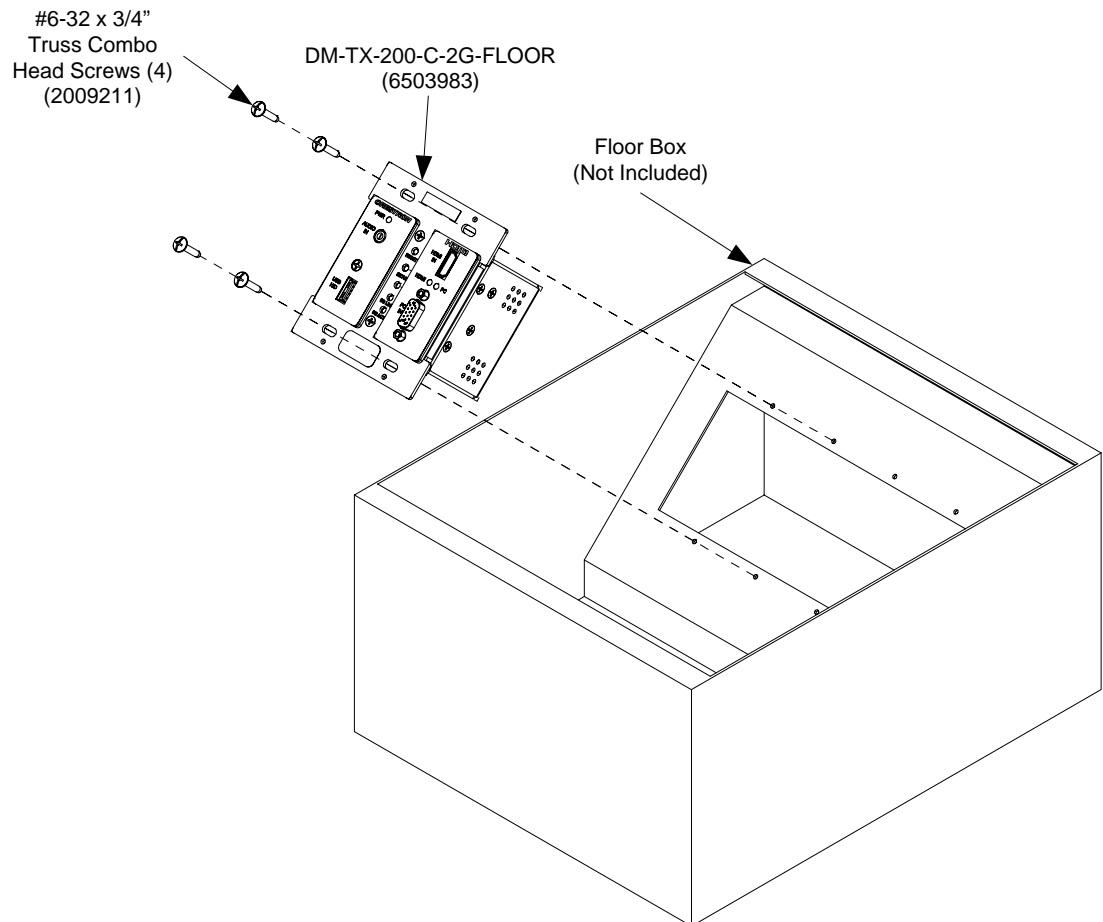

DM-TX-200-C-2G-WALL
Installation

The DM-TX-200-C-2G-WALL installs in a 2-gang electrical box (not included) in an insulated wall, floor, or ceiling. A minimum mounting depth of 2.5 inches (64 mm) is required.

NOTE: Before installing the DM-TX-200-C-2G-WALL in an electrical box, verify that the required wiring has been fed through the electrical box. Connect the wiring to the rear of the DM-TX-200-C-2G-WALL (refer to “Hardware Hookup” on page 21 for information about connections to the rear of the DM-TX-200-C-2G-WALL).

To install the DM-TX-200-C-2G-WALL in an electrical box, do the following (refer to the illustration below):

1. Using a Phillips head or straight blade screwdriver, attach the DM-TX-200-C-2G-WALL to the electrical box using the four included #6-32 x 3/4” truss combo head screws (2009211).
2. Attach the included black faceplate (2032185) or the included white faceplate (2032202) to the front panel of the DM-TX-200-C-2G-WALL.

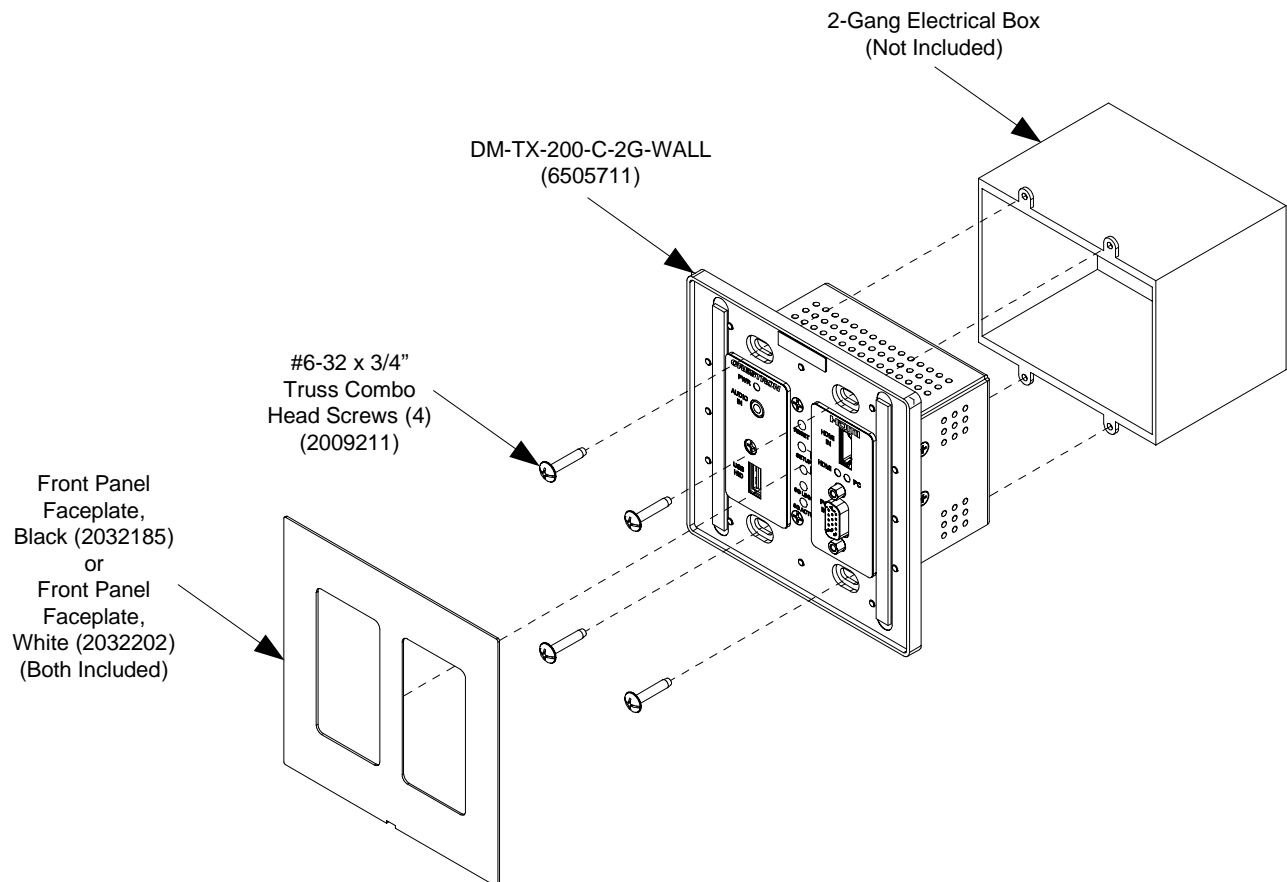
DM-TX-200-C-2G-WALL Installation in an Electrical Box

Hardware Hookup

Make the necessary connections as called out in the illustrations that follow this paragraph. Refer to “Network Wiring” on page 18.

NOTE: Hardware connections to the DM-TX-200-C-2G-FLOOR are illustrated below. Connections to the DM-TX-200-C-2G-WALL are the same as those for the DM-TX-200-C-2G-FLOOR.

Hardware Connections for the DM-TX-200-C-2G (DM-TX-200-C-2G-FLOOR, Front View Shown)

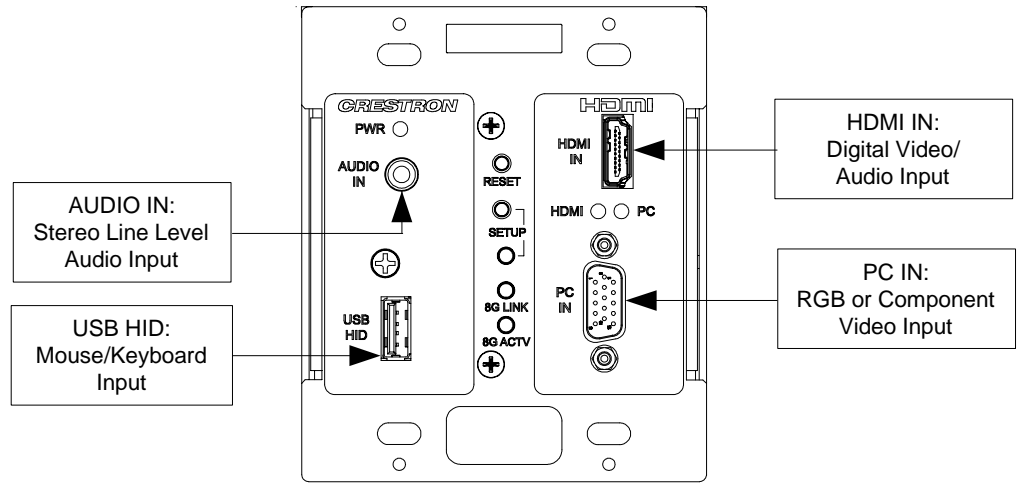

Hardware Connections for the DM-TX-200-C-2G (DM-TX-200-C-2G-FLOOR, Rear View Shown)

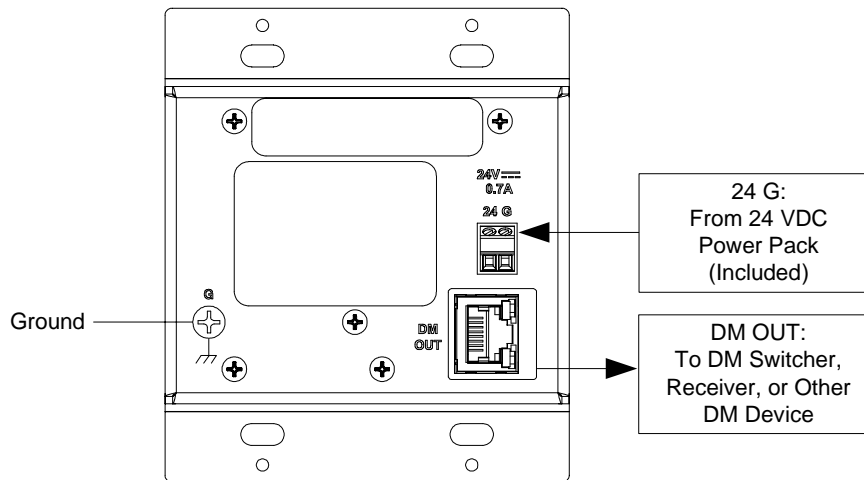

NOTE: Either the included 24 VDC power pack or PoDM—but not both—can be used to power the DM-TX-200-C-2G.

NOTE: Ensure that the unit is properly grounded by connecting the chassis ground lug to an earth ground (building steel).

NOTE: For DM 8G+ wiring up to 330 feet (100 meters) between devices, use Crestron DM-CBL-8G DigitalMedia 8G cable, Crestron DM-CBL DigitalMedia cable, Crestron DM-CBL-D DigitalMedia D cable, or generic CAT5e (or better) UTP or STP. Shielded cable and connectors are recommended to safeguard against unpredictable environmental electrical noise which may impact performance at resolutions above 1080p. Refer to the latest version of the Crestron DigitalMedia Infrastructure Guide (Doc. 4556) for complete wiring guidelines and to the Crestron DigitalMedia Design Guide (Doc. 4789) for complete system design guidelines.

Programming Software

Have a question or comment about Crestron software?

Answers to frequently asked questions (FAQs) can be viewed in the Online Help section of the Crestron Web site. To post a question or view questions you have submitted to Crestron's True Blue Support, log in at www.crestron.com/support. First-time users will need to establish a user account.

Earliest Version Software Requirements for the PC

NOTE: Crestron recommends that you use the latest software to take advantage of the most recently released features. The latest software is available from the Crestron Web site (www.crestron.com/software).

Crestron provides an assortment of Windows®-based software tools to develop a customized system. Use SIMPL Windows to create a program to control the DM-TX-200-C-2G.

Programming with SIMPL Windows

SIMPL Windows is Crestron's premier software for programming Crestron control systems. It is organized into two separate but equally important "Managers": Configuration and Program.

Configuration Manager

Configuration Manager is the view where programmers "build" a Crestron control system by selecting hardware from the *Device Library*.

1. To incorporate the DM-TX-200-C-2G into the system, drag the DM-TX-200-C-2G from the DigitalMedia | DM Transmitters folder of the *Device Library* and drop it into either of the following in *System Views*:
 - A compatible input card of a DM switcher
 - Directly to a card in the Ethernet slot of the control system (used without a DM switcher)

NOTE: In SIMPL Windows, the DM-TX-200-C-2G-FLOOR and the DM-TX-200-C-2G-WALL are referred to simply as the *DM-TX-200-C-2G*.

Locating the DM-TX-200-C-2G in the Device Library

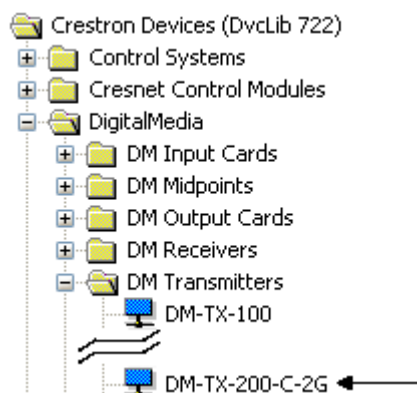

The system tree of the control system displays the DM-TX-200-C-2G in the appropriate slot with a default IP ID as shown in the following illustrations. In the first example, the DM-TX-200-C-2G is used with the DMC-C input card in a DM-MD8X8 switcher (both sold separately). In the second example, the DM-TX-200-C-2G is used with the C2ENET-2 card (sold separately) in an Ethernet slot on the control system.

C2ENET-2 Device, Slot 8 (Using Input Card in a DM Switcher)

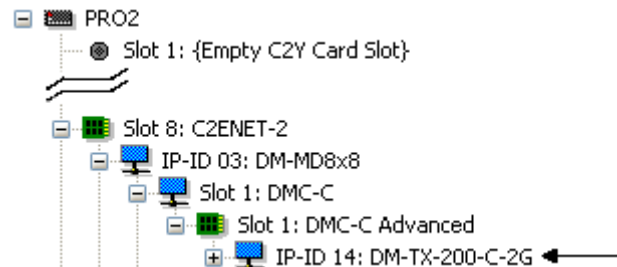

C2ENET-2 Device, Slot 8 (Using Ethernet Slot on Control System)

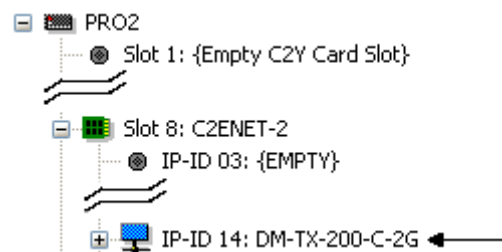

2. If additional DM-TX-200-C-2G devices are to be added, repeat step 1 for each device. Each DM-TX-200-C-2G device is assigned a different IP ID.
3. If necessary, double click a device to open the “Device Settings” dialog box and change the IP ID.

“Device Settings: Crestron DM-TX-200-C-2G” Dialog Box

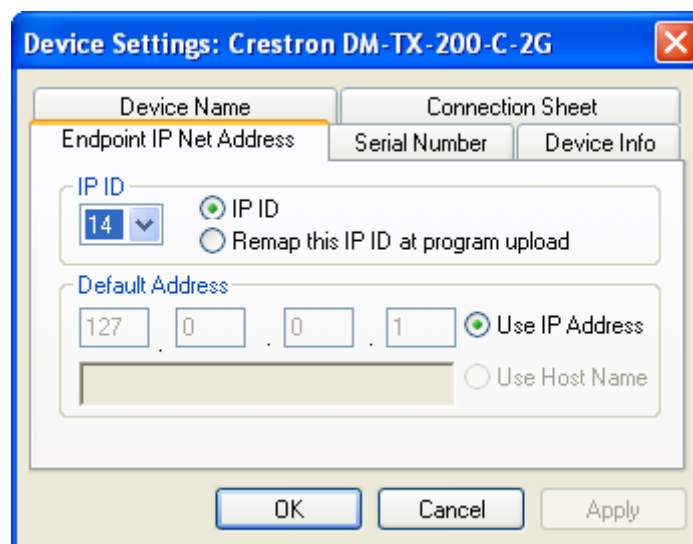

NOTE: The ID code specified in the SIMPL Windows program must match the IP ID of each unit. Refer to “Identity Code” on page 18.

Program Manager

Program Manager is the view where programmers “program” a Crestron control system by assigning signals to symbols.

The symbol can be viewed by double clicking on the icon or dragging it into *Detail View*. Each signal in the symbol is described in the SIMPL Windows help file (**F1**).

Uploading and Upgrading

Crestron recommends using the latest programming software and that each device contains the latest firmware to take advantage of the most recently released features. However, before attempting to upload or upgrade it is necessary to establish communication. Once communication has been established, files (for example, firmware) can be transferred to the control system (and/or device). In addition, the IP table of the device can be configured.

Establishing Communication

Use Crestron Toolbox for communicating with the DM-TX-200-C-2G; refer to the Crestron Toolbox help file for details.

A PC running Crestron Toolbox communicates with the DM-TX-200-C-2G in the following ways:

- Via a DM switcher using TCP/IP or USB communication. TCP/IP provides a faster method of communication than USB.
- Via a DM 8G+ receiver/room controller (for example, DM-RMC-100-C) using TCP/IP communication.

Via DM Switcher

TCP/IP Communication via DM Switcher



To establish TCP/IP communication between the PC and the DM-TX-200-C-2G via a DM switcher:

1. Establish communication between the PC and the DM switcher as described in the latest version of the DigitalMedia Switchers Operations Guide (Doc. 6755).
2. Use the Device Discovery Tool in Crestron Toolbox to find the IP address of the DM-TX-200-C-2G. The tool is available in Toolbox version 1.15.143 or later.
3. Use the Address Book in Crestron Toolbox to create an entry for the DM-TX-200-C-2G using the *TCP* connection type and enter the IP address of the DM-TX-200-C-2G.
4. Display the “System Info” of the DM-TX-200-C-2G (click the  icon); communications are confirmed when the device information is displayed.

USB Communication via DM Switcher

To establish USB communication between the PC and the DM-TX-200-C-2G via a DM switcher:

1. Use the Address Book in Crestron Toolbox to create an entry using the expected communication protocol (USB). When multiple USB devices are connected, identify the DM switcher by entering “DM-MD8X8”, “DM-MD16X16”, or “DM-MD32X32” in the *Model* textbox, the unit’s serial number in the *Serial* textbox, or the unit’s hostname in the *Hostname* textbox. The hostname can be found in the “System Info” window in the section marked *Ethernet*; however, communication must be established in order to see this information in the “System Info” window.
2. Display the “System Info” window of the DM-TX-200-C-2G (click the  icon); communications are confirmed when the device information is displayed.

*Via DM 8G+ Receiver/
Room Controller*

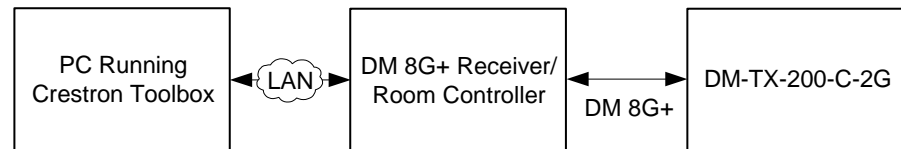
TCP/IP Communication via DM 8G+ Receiver/Room Controller

To establish TCP/IP communication between the PC and the DM-TX-200-C-2G via a DM 8G+ receiver/room controller:

1. Confirm Ethernet connection between DM 8G+ receiver/room controller and PC.
2. Use the Device Discovery Tool in Crestron Toolbox to find the IP address of the DM-TX-200-C-2G. The tool is available in Toolbox version 1.15.143 or later.

NOTE: When the DM-TX-200-C-2G is used in a standalone configuration (i.e., without a DM switcher), DHCP is enabled by default. If desired, a default IP address (192.168.1.239) can be assigned by holding down its **SETUP** button while applying power. This IP address overwrites any previous settings and remains until it is changed.

3. Use the Address Book in Crestron Toolbox to create an entry for the DM-TX-200-C-2G using the *TCP* connection type, and enter the IP address of the DM-TX-200-C-2G.
4. Display the “System Info” window of the DM-TX-200-C-2G (click the  icon); communications are confirmed when the device information is displayed.

5. (Optional) If additional changes to TCP/IP settings are desired, do the following:
 - a. Assign an IP address, IP mask, and default router for the DM-TX-200-C-2G via Crestron Toolbox (**Functions | Ethernet Addressing**).
 - b. Close the “System Info” window.
 - c. In Crestron Toolbox, change the Address Book entry for the DM-TX-200-C-2G so that it uses the IP address assigned in step 5a.
 - d. Display the “System Info” window of the DM-TX-200-C-2G (click the  icon); communications are confirmed when the device information is displayed.

Firmware

Firmware files may be distributed from programmers to installers or from Crestron to dealers. Firmware upgrades are available from the Crestron Web site as new features are developed after product releases. For details on upgrading, refer to the Crestron Toolbox help file.

Check the Crestron Web site to find the latest firmware. (New users may be required to register to obtain access to certain areas of the site, including the FTP site.)

To upgrade the DM-TX-200-C-2G firmware:

1. Do either of the following
 - If the DM-TX-200-C-2G is connected to a DM switcher, use the Device Discovery Tool in Crestron Toolbox to find the IP address of the switcher.
 - If the DM-TX-200-C-2G is being used in a standalone configuration (i.e., without a DM switcher), use the Device Discovery Tool to find the IP address of the DM-TX-200-C-2G.
2. Add the IP address found in step 1 to the Address Book in Toolbox.
3. Download the appropriate .puf file from the Crestron Web site to your PC.
4. Double-click the .puf file. The Toolbox Address Book opens.
5. From the list in the Address Book, select the DM switcher (if the DM-TX-200-C-2G is connected to a switcher) or the DM-TX-200-C-2G (if the DM-TX-200-C-2G is used in a standalone configuration), and then click **OK**.

Either of the following occurs:

- If the DM switcher was selected, a DM device list is displayed that allows upgrading of all DM devices connected to the switcher.
- If the DM-TX-200-C-2G was selected, a DM device list is displayed that allows upgrading of the DM-TX-200-C-2G only.

In the DM device lists that are displayed, the checkbox of any item that needs to be upgraded is automatically selected.

6. Click **Update**.
7. After the process is complete, click **Recheck** to verify the upgrade.

IP Configuration

If the DM-TX-200-C-2G is used in a standalone configuration (i.e., without a DM switcher), use Crestron Toolbox to create the IP table entry of the DM-TX-200-C-2G.

NOTE: If the DM-TX-200-C-2G is connected to a DM switcher, the IP table entry of the DM-TX-200-C-2G is created automatically.

1. Use the Device Discovery Tool in Crestron Toolbox to find the IP address of the DM-TX-200-C-2G. Then, display the “System Info” window (click the **i** icon) and select the DM-TX-200-C-2G entry from the Address Book.
2. Select **Functions | IP Table Setup**.
3. Add, modify or delete entries in the IP table. The DM-TX-200-C-2G can have only one IP table entry.
4. A defined IP table can be saved to a file or sent to the device.

DMTool

In the Crestron Toolbox Address Book, select the DM-TX-200-C-2G. Then use the DMTool to configure EDID, HDCP or to troubleshoot AV on the DM-TX-200-C-2G. Refer to the help file for additional information.

DMTool



Problem Solving

Troubleshooting

The following table provides corrective action for possible trouble situations. If further assistance is required, please contact a Crestron customer service representative.

DM-TX-200-C-2G Troubleshooting

TROUBLE	POSSIBLE CAUSE(S)	CORRECTIVE ACTION
PWR LED does not illuminate.	Device is not receiving power.	<p>If device is powered over DM:</p> <ul style="list-style-type: none"> Verify cable connections to the DM OUT port. Verify that device connected to the DM OUT port can provide power to this device. <p>If device is powered from power pack connected to 2-pin terminal block, verify power pack connections to the device and to the power outlet.</p>
8G LINK LED (front) and green LED on DM OUT port (rear) do not illuminate.	Device cannot establish a link to the device connected to the DM OUT port.	Verify cable connection to the DM OUT port.
	A problem exists with the FPGA firmware.	Reload the firmware using Crestron Toolbox.
Device cannot pass HDCP video from the DM OUT port.	Display connected to the DM OUT port is not HDCP compliant.	Verify that HDMI IN content is HDCP protected and that DM OUT amber LED is blinking.
Device cannot pass audio and video from HDMI input.	HDMI input is not selected.	Verify that HDMI is routed on device symbol.
	HDMI source is not transmitting.	Verify that HDMI IN LED is illuminated.
Device cannot pass audio and video from PC input.	PC input is not selected.	Verify that PC input is routed on device symbol.
	PC source is not transmitting.	Verify that PC LED is illuminated.
Loss of functionality due to electrostatic discharge.	Improper grounding.	Check that all ground connections have been made properly.

NOTE: For more advanced diagnostics, use the DMTool in Crestron Toolbox.

Reference Documents

The latest version of all documents mentioned within the guide can be obtained from the Crestron Web site.

List of Related Reference Documents

DOCUMENT TITLE
Crestron DigitalMedia Design Guide (www.crestron.com/dmresources)
Crestron DigitalMedia Infrastructure Guide (www.crestron.com/dmresources)
Crestron DigitalMedia Switchers Operations Guide (www.crestron.com/manuals)
Crestron IP Considerations Guide for the IT Professional (www.crestron.com/dmresources)

Further Inquiries

If you cannot locate specific information or have questions after reviewing this guide, please take advantage of Crestron's award winning customer service team by calling Crestron at 1-888-CRESTRON [1-888-273-7876]. For assistance in your region, please refer to the Crestron Web site (www.crestron.com) for a listing of Crestron worldwide offices.

You can also log onto the online help section of the Crestron Web site (www.crestron.com/onlinehelp) to ask questions about Crestron products. First-time users will need to establish a user account to fully benefit from all available features.

Future Updates

As Crestron improves functions, adds new features and extends the capabilities of the DM-TX-200-C-2G-FLOOR/DM-TX-200-C-2G-WALL, additional information may be made available as manual updates. These updates are solely electronic and serve as intermediary supplements prior to the release of a complete technical documentation revision.

Check the Crestron Web site periodically for manual update availability and its relevance. Updates are identified as an “Addendum” in the Download column.

Return and Warranty Policies

Merchandise Returns / Repair Service

1. No merchandise may be returned for credit, exchange or service without prior authorization from CRESTRON. To obtain warranty service for CRESTRON products, contact an authorized CRESTRON dealer. Only authorized CRESTRON dealers may contact the factory and request an RMA (Return Merchandise Authorization) number. Enclose a note specifying the nature of the problem, name and phone number of contact person, RMA number and return address.
2. Products may be returned for credit, exchange or service with a CRESTRON Return Merchandise Authorization (RMA) number. Authorized returns must be shipped freight prepaid to CRESTRON, 6 Volvo Drive, Rockleigh, N.J. or its authorized subsidiaries, with RMA number clearly marked on the outside of all cartons. Shipments arriving freight collect or without an RMA number shall be subject to refusal. CRESTRON reserves the right in its sole and absolute discretion to charge a 15% restocking fee plus shipping costs on any products returned with an RMA.
3. Return freight charges following repair of items under warranty shall be paid by CRESTRON, shipping by standard ground carrier. In the event repairs are found to be non-warranty, return freight costs shall be paid by the purchaser.

CRESTRON Limited Warranty

CRESTRON ELECTRONICS, Inc. warrants its products to be free from manufacturing defects in materials and workmanship under normal use for a period of three (3) years from the date of purchase from CRESTRON, with the following exceptions: disk drives and any other moving or rotating mechanical parts, pan/tilt heads and power supplies are covered for a period of one (1) year; touch screen display and overlay components are covered for 90 days; batteries and incandescent lamps are not covered.

This warranty extends to products purchased directly from CRESTRON or an authorized CRESTRON dealer. Purchasers should inquire of the dealer regarding the nature and extent of the dealer's warranty, if any.

CRESTRON shall not be liable to honor the terms of this warranty if the product has been used in any application other than that for which it was intended or if it has been subjected to misuse, accidental damage, modification or improper installation procedures. Furthermore, this warranty does not cover any product that has had the serial number altered, defaced or removed.

This warranty shall be the sole and exclusive remedy to the original purchaser. In no event shall CRESTRON be liable for incidental or consequential damages of any kind (property or economic damages inclusive) arising from the sale or use of this equipment. CRESTRON is not liable for any claim made by a third party or made by the purchaser for a third party.

CRESTRON shall, at its option, repair or replace any product found defective, without charge for parts or labor. Repaired or replaced equipment and parts supplied under this warranty shall be covered only by the unexpired portion of the warranty.

Except as expressly set forth in this warranty, CRESTRON makes no other warranties, expressed or implied, nor authorizes any other party to offer any warranty, including any implied warranties of merchantability or fitness for a particular purpose. Any implied warranties that may be imposed by law are limited to the terms of this limited warranty. This warranty statement supersedes all previous warranties.

GNU General Public License

Version 2, June 1991

Copyright (C) 1989, 1991 Free Software Foundation, Inc., 51 Franklin Street, Fifth Floor, Boston, MA 02110-1301 USA
Everyone is permitted to copy and distribute verbatim copies of this license document but changing it is not allowed.

PREAMBLE

The licenses for most software are designed to take away your freedom to share and change it. By contrast, the GNU General Public License is intended to guarantee your freedom to share and change free software--to make sure the software is free for all its users. This General Public License applies to most of the Free Software Foundation's software and to any other program whose authors commit to using it. (Some other Free Software Foundation software is covered by the GNU Lesser General Public License instead.) You can apply it to your programs too.

When we speak of free software, we are referring to freedom, not price. Our General Public Licenses are designed to make sure that you have the freedom to distribute copies of free software (and charge for this service if you wish), that you receive source code or can get it if you want it, that you can change the software or use pieces of it in new free programs and that you know you can do these things.

To protect your rights, we need to make restrictions that forbid anyone to deny you these rights or to ask you to surrender the rights. These restrictions translate to certain responsibilities for you if you distribute copies of the software or if you modify it.

For example, if you distribute copies of such a program, whether gratis or for a fee, you must give the recipients all the rights that you have. You must make sure that they too receive or can get the source code. And you must show them these terms so they know their rights.

We protect your rights with two steps: (1) copyright the software, and (2) offer you this license which gives you legal permission to copy, distribute and/or modify the software.

Also, for each author's protection and ours, we want to make certain that everyone understands that there is no warranty for this free software. If the software is modified by someone else and passed on, we want its recipients to know that what they have is not the original, so that any problems introduced by others will not reflect on the original authors' reputations.

Finally, any free program is threatened constantly by software patents. We wish to avoid the danger that redistributors of a free program will individually obtain patent licenses, in effect making the program proprietary. To prevent this, we have made it clear that any patent must be licensed for everyone's free use or not licensed at all.

The precise terms and conditions for copying, distribution and modification follow.

GNU GENERAL PUBLIC LICENSE TERMS AND CONDITIONS FOR COPYING, DISTRIBUTION AND MODIFICATION

0. This License applies to any program or other work which contains a notice placed by the copyright holder saying it may be distributed under the terms of this General Public License. The "Program" below refers to any such program or work, and a "work based on the Program" means either the Program or any derivative work under copyright law: that is to say, a work containing the Program or a portion of it, either verbatim or with modifications and/or translated into another language. (Hereinafter, translation is included without limitation in the term "modification".) Each licensee is addressed as "you".

Activities other than copying, distribution and modification are not covered by this License; they are outside its scope. The act of running the Program is not restricted, and the output from the Program is covered only if its contents constitute a work based on the Program (independent of having been made by running the Program). Whether that is true depends on what the Program does.

1. You may copy and distribute verbatim copies of the Program's source code as you receive it, in any medium, provided that you conspicuously and appropriately publish on each copy an appropriate copyright notice and disclaimer of warranty; keep intact all the notices that refer to this License and to the absence of any warranty; and give any other recipients of the Program a copy of this License along with the Program.

You may charge a fee for the physical act of transferring a copy and you may at your option offer warranty protection in exchange for a fee.

2. You may modify your copy or copies of the Program or any portion of it, thus forming a work based on the Program, and copy and distribute such modifications or work under the terms of Section 1 above, provided that you also meet all of these conditions:

- a) You must cause the modified files to carry prominent notices stating that you changed the files and the date of any change.
- b) You must cause any work that you distribute or publish, that in whole or in part contains or is derived from the Program or any part thereof, to be licensed as a whole at no charge to all third parties under the terms of this License.
- c) If the modified program normally reads commands interactively when run, you must cause it, when started running for such interactive use in the most ordinary way, to print or display an announcement including an appropriate copyright notice and a notice that there is no warranty (or else, saying that you provide a warranty) and that users may redistribute the program under these conditions, and telling the user how to view a copy of this License. (Exception: if the Program itself is interactive but does not normally print such an announcement, your work based on the Program is not required to print an announcement.)

These requirements apply to the modified work as a whole. If identifiable sections of that work are not derived from the Program and can be reasonably considered independent and separate works in themselves, then this License and its terms do not apply to those sections when you distribute them as separate works. But when you distribute the same sections as part of a whole which is a work based on the Program, the distribution of the whole must be on the terms of this License, whose permissions for other licensees extend to the entire whole and thus to each and every part regardless of who wrote it.

Thus, it is not the intent of this section to claim rights or contest your rights to work written entirely by you; rather, the intent is to exercise the right to control the distribution of derivative or collective works based on the Program.

In addition, mere aggregation of another work not based on the Program with the Program (or with a work based on the Program) on a volume of a storage or distribution medium does not bring the other work under the scope of this License.

3. You may copy and distribute the Program (or a work based on it, under Section 2) in object code or executable form under the terms of Sections 1 and 2 above provided that you also do one of the following:

- a) Accompany it with the complete corresponding machine-readable source code, which must be distributed under the terms of Sections 1 and 2 above on a medium customarily used for software interchange; or,
- b) Accompany it with a written offer, valid for at least three years, to give any third party, for a charge no more than your cost of physically performing source distribution, a complete machine-readable copy of the corresponding source code, to be distributed under the terms of Sections 1 and 2 above on a medium customarily used for software interchange; or,
- c) Accompany it with the information you received as to the offer to distribute corresponding source code. (This alternative is allowed only for noncommercial distribution and only if you received the program in object code or executable form with such an offer, in accord with Subsection b above.)

The source code for a work means the preferred form of the work for making modifications to it. For an executable work, complete source code means all the source code for all modules it contains, plus any associated interface definition files, plus the scripts used to control compilation and installation of the executable. However, as a special exception, the source code distributed need not include anything that is normally distributed (in either source or binary form) with the major components (compiler, kernel and so on) of the operating system on which the executable runs, unless that component itself accompanies the executable.

If distribution of executable or object code is made by offering access to copy from a designated place, then offering equivalent access to copy the source code from the same place counts as distribution of the source code, even though third parties are not compelled to copy the source along with the object code.

4. You may not copy, modify, sublicense or distribute the Program except as expressly provided under this License. Any attempt otherwise to copy, modify, sublicense or distribute the Program is void and will automatically terminate your rights under this License. However, parties who have received copies or rights, from you under this License will not have their licenses terminated so long as such parties remain in full compliance.

5. You are not required to accept this License, since you have not signed it. However, nothing else grants you permission to modify or distribute the Program or its derivative works. These actions are prohibited by law if you do not accept this License. Therefore, by modifying or distributing the Program (or any work based on the Program), you indicate your acceptance of this License to do so and all its terms and conditions for copying, distributing or modifying the Program or works based on it.

6. Each time you redistribute the Program (or any work based on the Program), the recipient automatically receives a license from the original licensor to copy, distribute or modify the Program subject to these terms and conditions. You may not impose any further restrictions on the recipients' exercise of the rights granted herein. You are not responsible for enforcing compliance by third parties to this License.

7. If, as a consequence of a court judgment or allegation of patent infringement or for any other reason (not limited to patent issues), conditions are imposed on you (whether by court order, agreement or otherwise) that contradict the conditions of this License, they do not excuse you from the conditions of this License. If you cannot distribute so as to satisfy simultaneously your obligations under this License and any other pertinent obligations, then as a consequence you may not distribute the Program at all. For example, if a patent license would not permit royalty-free redistribution of the Program by all those who receive copies directly or indirectly through you, then the only way you could satisfy both it and this License would be to refrain entirely from distribution of the Program.

If any portion of this section is held invalid or unenforceable under any particular circumstance, the balance of the section is intended to apply and the section as a whole is intended to apply in other circumstances.

It is not the purpose of this section to induce you to infringe any patents or other property right claims or to contest validity of any such claims; this section has the sole purpose of protecting the integrity of the free software distribution system, which is implemented by public license practices. Many people have made generous contributions to the wide range of software distributed through that system in reliance on consistent application of that system; it is up to the author/donor to decide if he or she is willing to distribute software through any other system and a licensee cannot impose that choice.

This section is intended to make thoroughly clear what is believed to be a consequence of the rest of this License.

8. If the distribution and/or use of the Program is restricted in certain countries either by patents or by copyrighted interfaces, the original copyright holder who places the Program under this License may add an explicit geographical distribution limitation excluding those countries, so that distribution is permitted only in or among countries not thus excluded. In such case, this License incorporates the limitation as if written in the body of this License.

9. The Free Software Foundation may publish revised and/or new versions of the General Public License from time to time. Such new versions will be similar in spirit to the present version but may differ in detail to address new problems or concerns.

Each version is given a distinguishing version number. If the Program specifies a version number of this License which applies to it and "any later version", you have the option of following the terms and conditions either of that version or of any later version published by the Free Software Foundation. If the Program does not specify a version number of this License, you may choose any version ever published by the Free Software Foundation.

10. If you wish to incorporate parts of the Program into other free programs whose distribution conditions are different, write to the author to ask for permission. For software which is copyrighted by the Free Software Foundation, write to the Free Software Foundation; we sometimes make exceptions for this. Our decision will be guided by the two goals of preserving the free status of all derivatives of our free software and of promoting the sharing and reuse of software generally.

NO WARRANTY

11. BECAUSE THE PROGRAM IS LICENSED FREE OF CHARGE, THERE IS NO WARRANTY FOR THE PROGRAM, TO THE EXTENT PERMITTED BY APPLICABLE LAW. EXCEPT WHEN OTHERWISE STATED IN WRITING THE COPYRIGHT HOLDERS AND/OR OTHER PARTIES PROVIDE THE PROGRAM "AS IS" WITHOUT WARRANTY OF ANY KIND, EITHER EXPRESSED OR IMPLIED, INCLUDING BUT NOT LIMITED TO, THE IMPLIED WARRANTIES OF MERCHANTABILITY AND FITNESS FOR A PARTICULAR PURPOSE. THE ENTIRE RISK AS TO THE QUALITY AND PERFORMANCE OF THE PROGRAM IS WITH YOU. SHOULD THE PROGRAM PROVE DEFECTIVE, YOU ASSUME THE COST OF ALL NECESSARY SERVICING, REPAIR OR CORRECTION.

12. IN NO EVENT UNLESS REQUIRED BY APPLICABLE LAW OR AGREED TO IN WRITING WILL ANY COPYRIGHT HOLDER OR ANY OTHER PARTY WHO MAY MODIFY AND/OR REDISTRIBUTE THE PROGRAM AS PERMITTED ABOVE, BE LIABLE TO YOU FOR DAMAGES, INCLUDING ANY GENERAL, SPECIAL, INCIDENTAL OR CONSEQUENTIAL DAMAGES ARISING OUT OF THE USE OR INABILITY TO USE THE PROGRAM (INCLUDING BUT NOT LIMITED TO LOSS OF DATA OR DATA BEING RENDERED INACCURATE OR LOSSES SUSTAINED BY YOU OR THIRD PARTIES OR A FAILURE OF THE PROGRAM TO OPERATE WITH ANY OTHER PROGRAMS), EVEN IF SUCH HOLDER OR OTHER PARTY HAS BEEN ADVISED OF THE POSSIBILITY OF SUCH DAMAGES.



Crestron Electronics, Inc.
15 Volvo Drive Rockleigh, NJ 07647
Tel: 888.CRESTRON
Fax: 201.767.7576
www.crestron.com

**Operations & Installation Guide – DOC. 7255B
(2032216)**

10.11

Specifications subject to
change without notice.