

# CERTIFICATE OF COMPLIANCE

**Certificate Number** 20181024-E188325  
**Report Reference** E188325-20181017  
**Issue Date** 2018-OCTOBER-24

**Issued to:** Askey Computer Corp  
5-10F 119 Jiankang Rd  
Zhonghe District  
New Taipei, 23585 TAIWAN

**This is to certify that  
representative samples of**

AUDIO/VIDEO, INFORMATION AND COMMUNICATION  
TECHNOLOGY EQUIPMENT  
1-to-4 4K HDMI Distribution Amplifier, Model HD-DA4-4KZ-  
E.

Have been investigated by UL in accordance with the  
Standard(s) indicated on this Certificate.

**Standard(s) for Safety:**

UL 62368-1 and CAN/CSA C22.2 No. 62368-1-14,  
Audio/video, Information and Communication Technology  
Equipment - Part 1: Safety Requirements.

**Additional Information:**

See the UL Online Certifications Directory at  
[www.ul.com/database](http://www.ul.com/database) for additional information

Only those products bearing the UL Certification Mark should be considered as being covered by UL's  
Certification and Follow-Up Service.

Look for the UL Certification Mark on the product.



Bruce Mahrenholz, Director North American Certification Program

UL LLC

Any information and documentation involving UL Mark services are provided on behalf of UL LLC (UL) or any authorized licensee of UL. For questions, please  
contact a local UL Customer Service Representative at <http://ul.com/aboutul/locations/>



File E188325  
Project 4788599967

October 17, 2018

REPORT

on

Audio/Video, Information and Communication Technology Equipment

ASKEY COMPUTER CORP  
New Taipei, TAIWAN

Copyright © 2018 UL LLC

UL LLC authorizes the above named company to reproduce this Report only for purposes as described in the Conclusion, provided it is reproduced in its entirety.

| <b>UL TEST REPORT AND PROCEDURE</b> |   |
|-------------------------------------|---|
| <b>Standard:</b>                    | UL 62368-1, 2nd Edition, 2014-12-01 (Audio/video, Information and Communication Technology Equipment - Part 1: Safety Requirements)<br>CAN/CSA C22.2 No. 62368-1-14, 2nd Edition, 2014-12 (Audio/video, Information and Communication Technology Equipment - Part 1: Safety Requirements) |
| <b>Certification Type:</b>          | Listing   |
| <b>CCN:</b>                         | AZOT, AZOT7 (Audio/Video, Information and Communication Technology Equipment)   |
| <b>Product:</b>                     | 1-to-4 4K HDMI Distribution Amplifier   |
| <b>Model:</b>                       | HD-DA4-4KZ-E  |
| <b>Rating:</b>                      | 24 Vdc, 0.75 A  |
| <b>Applicant Name and Address:</b>  | ASKEY COMPUTER CORP<br>5-10F 119 JIANKANG RD<br>ZHONGHE DISTRICT<br>NEW TAIPEI<br>23585 TAIWAN  |

This is to certify that representative samples of the products covered by this Test Report have been investigated in accordance with the above referenced Standards. The products have been found to comply with the requirements covering the category and the products are judged to be eligible for Follow-Up Service under the indicated Test Procedure. The manufacturer is authorized to use the UL Mark on such products which comply with this Test Report and any other applicable requirements of UL LLC ('UL') in accordance with the Follow-Up Service Agreement. Only those products which properly bear the UL Mark are considered as being covered by UL's Follow-Up Service under the indicated Test Procedure.

The applicant is authorized to reproduce the referenced Test Report provided it is reproduced in its entirety.

[ ] UL authorizes the applicant to reproduce the latest pages of the referenced Test Report consisting of this page through to the end of the Engineering Conditions of Acceptability.

Any information and documentation involving UL Mark services are provided on behalf of UL LLC (UL) or any authorized licensee of UL

Prepared by: Winnie Su

Reviewed by: Terence She

**Supporting Documentation**

The following documents located at the beginning of this Procedure supplement the requirements of this Test Report:

- A. Authorization - The Authorization page may include additional Factory Identification Code markings.
- B. Generic Inspection Instructions -
  - i. Part AC details important information which may be applicable to products covered by this Procedure. Products described in this Test Report must comply with any applicable items listed unless otherwise stated in the body of this Test Report
  - ii. Part AE details any requirements which may be applicable to all products covered by this Procedure. Products described in this Test Report must comply with any applicable items listed unless otherwise stated in the body of each Test Report
- C. Listing Mark/Recognized Component Mark Data Page - details the requirements for the UL Certification Mark which is not controlled by the technical standard used to investigate these products. Products are permitted to bear only the Certification Mark(s) corresponding to the countries for which it is certified, as indicated in each Test Report.

**Product Description**

- The EUT is a Class III 1-to-4 4K HDMI Distribution Amplifier. The unit will be connected to a certified power adapter whose DC-output complied with L.P.S., ref. list of critical components. Besides, the EUT is intended to be used for indoor place.

- Electronic components were mounted on PWB, then housed within metal enclosure.

- The EUT contains output ports: (HDMI port x4, USB 2.0 port x1) and input port (HDMI port x1, DC jack x1).

**Model Differences**

N/A

**Test Item Particulars (NOT FOR FIELD REPRESENTATIVE'S USE)**

Classification of installation and use by .....:  Ordinary person  Instructed person  
 Skilled person

Supply Connection .....:  pluggable equipment  type A  type B  
 permanent connection  
 detachable power supply cord  
 non-detachable power supply cord  
 not directly connected to the mains

Equipment mobility .....:  movable  hand-held  transportable  
 stationary  for building-in  direct plug-in  
 rack-mounting  wall-mounted

Over voltage category (OVC) .....:  OVC I  OVC II  OVC III  OVC IV  
 other: no direct connect to mains

Fundamental Frequency.....:  50/60 Hz  50 Hz  60 Hz  other\_\_\_\_\_Hz

Class of equipment .....:  Class I  Class II  Class III  
 Not classified

Access location .....:  restricted access location  N/A

Pollution degree (PD) .....:  PD 1  PD 2  PD 3

IP protection class .....:  IP X0  IP \_\_\_\_

Tested for IT power systems .....:  Yes  No

IT testing, phase-phase voltage (V) .....:  \_\_\_\_  N/A

Altitude during operation (m) .....:  Up to 2,000  Up to 5000

Altitude of test laboratory (m) .....:  Less than 2,000  Approximately \_\_\_\_

Mass of equipment (kg) .....: Approx. 0.57 kg

**Technical Consideration (NOT FOR FIELD REPRESENTATIVE'S USE)**

- The product was submitted and evaluated for use at the maximum ambient temperature (Tma) permitted by the manufacturer's specification of: 45 °C
- The following circuit locations (with circuit/schematic designation) were investigated as a limited power source (LPS): All external output ports.
- The following are available from the Applicant upon request: Installation (Safety) Instructions / Manual.
- LEDs provided in the product are considered low power devices: Yes
- Based upon the product specification provided by the manufacturer, this unit is intended to be supplied by an UL Listed power supply suitable for use at Tma 45 degree C whose output meets SELV or ES1, LPS or PS2 and is rated 24Vdc, 0.75A min.
- Maximum normal load: The equipment with normal operated continuously; dummy load of 2.5 W in connection to represent USB port (type 2.0) (x1), HDMI output port (x4) connects to two screens at the same time.

**Additional Information**

N/A

**Additional Standard**

The product fulfils the requirements of: N/A

| <b>Markings, instructions and instructional safeguards</b>  |   |        |
|---|---|--------|
| <b>Clause Title</b>   | <b>Marking or Instruction Details</b>                                       |        |
|   | English   | French |
| Equipment identification marking – Manufacturer identification  | Listee's or Recognized company's name, Trade Name, Trademark or File Number |        |
| Equipment identification marking – model identification   | Model Number  |        |
| Equipment rating marking –ratings   | Input Ratings (voltage, frequency/dc, current/power)                        |        |
| Inter-connecting cables - External detachable   | Listee's Name and Part number (Marking or Instruction)                      |        |
| Manual for Wall Mount Instruction   | See Enclosure Id Illustration-03 for details.                               |        |
| <b>Special Instructions to UL Representative</b>  |   |        |
| The Field Representative should verify the Tma (maximum ambient temperature) is minimum 45 degree C, LPS or PS2 from the updated version of UL reports for power source which was/were certified by UL60950-1, 2nd edition, date 2014-10-14 or UL 62368-1, 2nd Edition, 2014-12-01 or newest (provide from customer). |   |        |

| <b>Production-Line Testing Requirements</b>   |           |                 |                     |           |                |              |
|---|-----------|-----------------|---------------------|-----------|----------------|--------------|
| <b><u>Electric Strength Test Special Constructions - Refer to Generic Inspection Instructions, Part AC for further information.</u></b>   |           |                 |                     |           |                |              |
| Model   | Component | Removable Parts | Test probe location | V rms     | V dc           | Test Time, s |
| N/A   |           |                 |                     |           |                |              |
| <b><u>Earthing Continuity Test Exemptions - This test is not required for the following models:</u></b>   |           |                 |                     |           |                |              |
| N/A   |           |                 |                     |           |                |              |
| <b><u>Electric Strength Test Exemptions - This test is not required for the following models:</u></b>   |           |                 |                     |           |                |              |
| N/A   |           |                 |                     |           |                |              |
| <b><u>Electric Strength Test Component Exemptions - The following solid-state components may be disconnected from the remainder of the circuitry during the performance of this test:</u></b> |           |                 |                     |           |                |              |
| N/A   |           |                 |                     |           |                |              |
| <b><u>Sample and Test Specifics for Follow-Up Tests at UL</u></b>   |           |                 |                     |           |                |              |
| Model   | Component | Material        | Test                | Sample(s) | Test Specifics |              |
| N/A   |           |                 |                     |           |                |              |



| 4.1.2  | TABLE: list of critical components |            |   |                            |                                    | Pass          |
|--|------------------------------------|------------|---|----------------------------|------------------------------------|---------------|
| Object/part or Description                                       | Manufacturer/<br>trademark         | type/model | technical data  | Product Category<br>CCN(s) | Required<br>Marks of<br>Conformity | Supplement ID |
| S01. Label   | Various                            | Various    | 60 degree C min.  | PGDQ2 or PGJ12             | UL                                 |               |
| S01a. Permanency of Marking (alternate)                          | --                                 | --         | Engraved laser marking.   | --                         | --                                 |               |
| S01b. Permanency of Marking (alternate)                          | --                                 | --         | Permanently ink-stamped, silk-screened, molded in, or in self-adhesive labels.  | --                         | --                                 |               |
| S02. Internal Plastic Part Materials                             | Various                            | Various    | V-2 or HF-2 min.  | QMFZ2                      | UL                                 |               |
| S03. Connectors and Receptacles (secondary circuit)              | Various                            | Various    | --  | ECBT2 or RTRT2 or DUXR2    | UL                                 |               |
| S03a. Connectors and Receptacles (secondary circuit) (alternate) | Various                            | Various    | Copper alloy pins housed in bodies of plastic rated V-2 min.  | QMFZ2                      | UL                                 |               |
| S03b. Connectors and Receptacles (secondary circuit) (Alternate) | --                                 | --         | Flammability level is ignored, when small part (a mass less than 4 g or a size of less than 1750 mm <sup>3</sup> ) is mounted on V-1 class material | --                         | --                                 |               |
| S04. Interconnecting Cable (optional)                            | Various                            | Various    | Minimum 60 degree C, 30 V minimum, maximum 3.05 m long, jacketed, VW-1 or FT-1 or better  | AVLV2 or DVPJ              | UL                                 |               |
| S04a. Interconnecting Cable (optional) (alternate)               | Various                            | Various    | Maximum 3.05 m long, jacketed, type CMP, CMR, CMG, CM, CMX, CMUC, CMH   | DUZX                       | UL                                 |               |

|  |                        |                    |  |              |    |  |
|--|------------------------|--------------------|--|--------------|----|--|
|  |                        |                    | or rated FT4   |              |    |  |
| S04b. Interconnecting Cable (optional) (alternate) | Various                | Various            | Maximum 3.05 m long.   | DUXR         | UL |  |
| S05. Printed Wiring Boards                         | Various                | Various            | V-1 min., 105 degree C min.  | ZPMV2        | UL |  |
| 01. External Power Supply Source                   | NETBIT ELECTRONICS LTD | NBS24J240075D<br>5 | I/P:<br>100-120 Vac or 100-240 Vac,<br>50/60 Hz, 0.6 A.<br><br>O/P:<br>24 Vdc, 0.75 A., LPS., 5000 m<br>Class II, 45 °C. Direct plug-in<br>type. | QQGQ, AZSQ   | UL |  |
| 01a. External Power Supply Source (Alternate)      | Various                | Various            | O/P: 24Vdc, 0.75A min.; LPS<br>or PS2; 2000 m min.; 45<br>degree C min. Direct plug-in<br>type. Class II.  | QQGQ or QQJQ | UL |  |
| 02. Metal Enclosure                                | --                     | --                 | Galvanized Steel. Think 1.0<br>mm min. See Enclosure Id<br>Illustration-01 for details.  | --           | -- |  |
| 03. Heatsink (Fixed on U1)                         | --                     | --                 | Ceramic. See Enclosure Id<br>Illustration-02 for details.  | --           | -- |  |

**ENCLOSURES**

| <u>Type</u>   | <u>Supplement Id</u> | <u>Description</u>          |
|---------------|----------------------|-----------------------------|
| Photographs   | Figure-01            | External View 1             |
| Photographs   | Figure-02            | External View 2             |
| Photographs   | Figure-03            | I/O ports View 1            |
| Photographs   | Figure-04            | I/O ports View 2            |
| Photographs   | Figure-05            | Internal View               |
| Photographs   | Figure-06            | Main board View 1           |
| Photographs   | Figure-07            | Main board View 2           |
| Illustrations | Illustration-01      | Enclosure dimension drawing |
| Illustrations | Illustration-02      | Heatsink dimension drawing  |
| Manuals       | Illustration-03      | User's manual               |

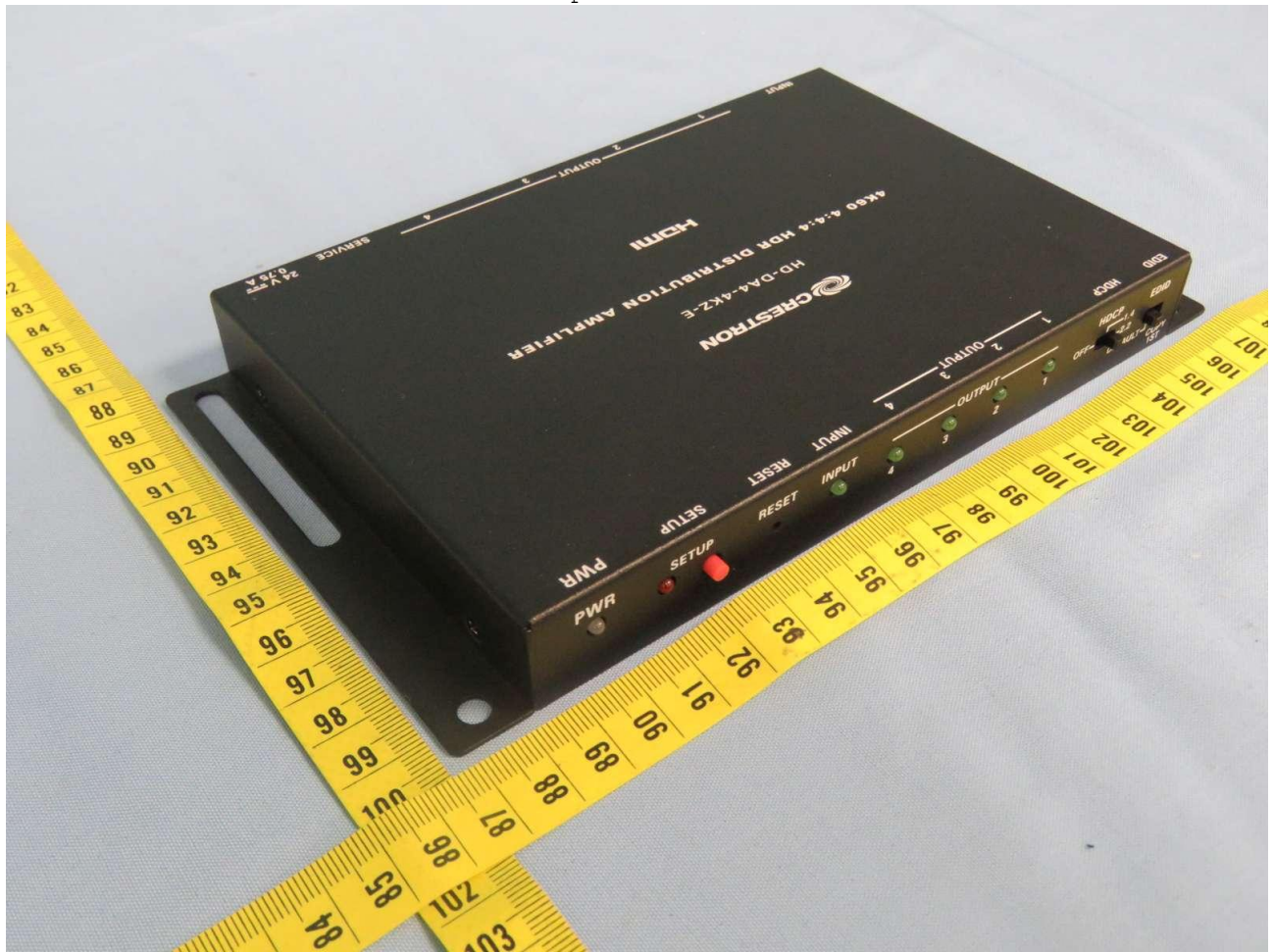

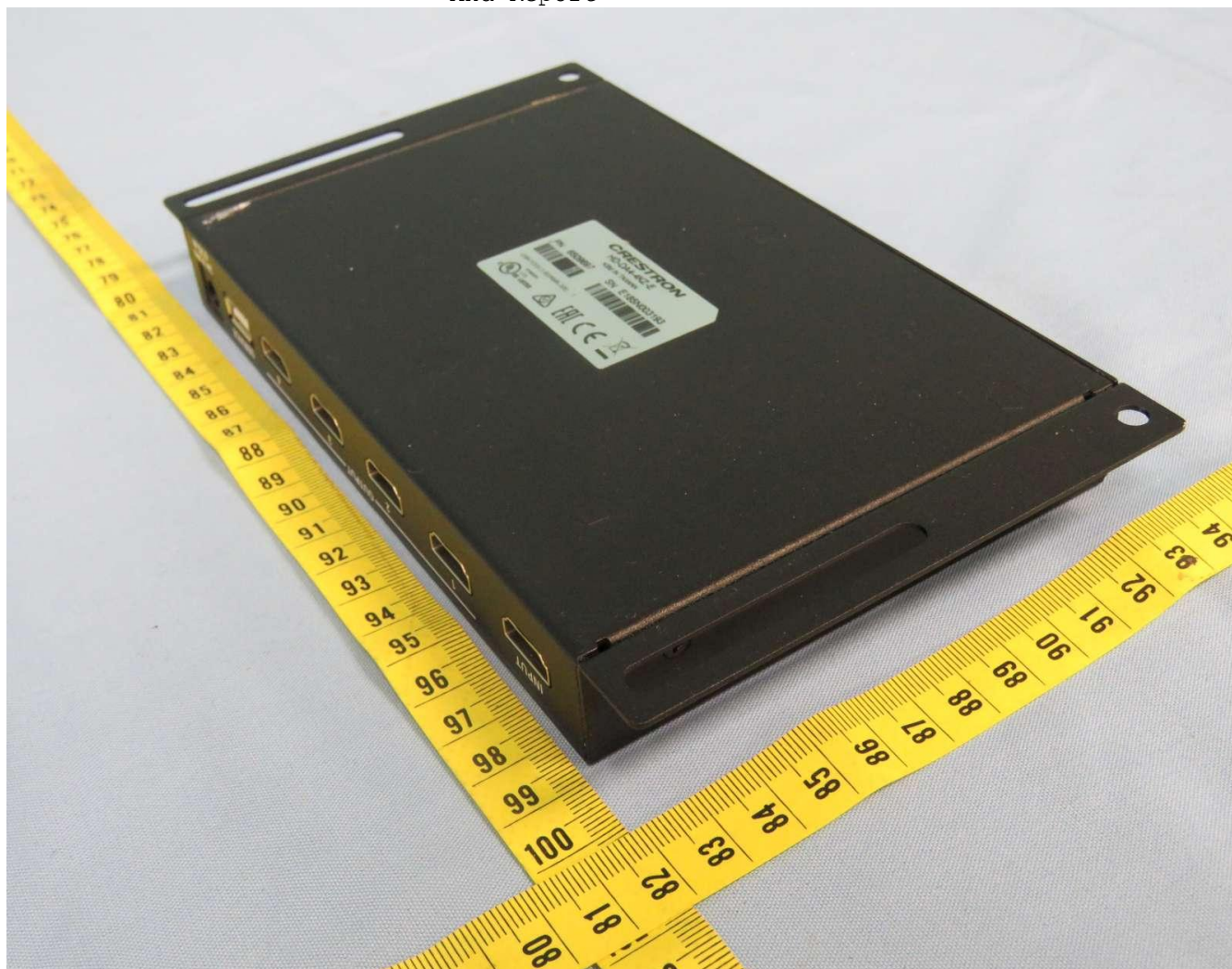



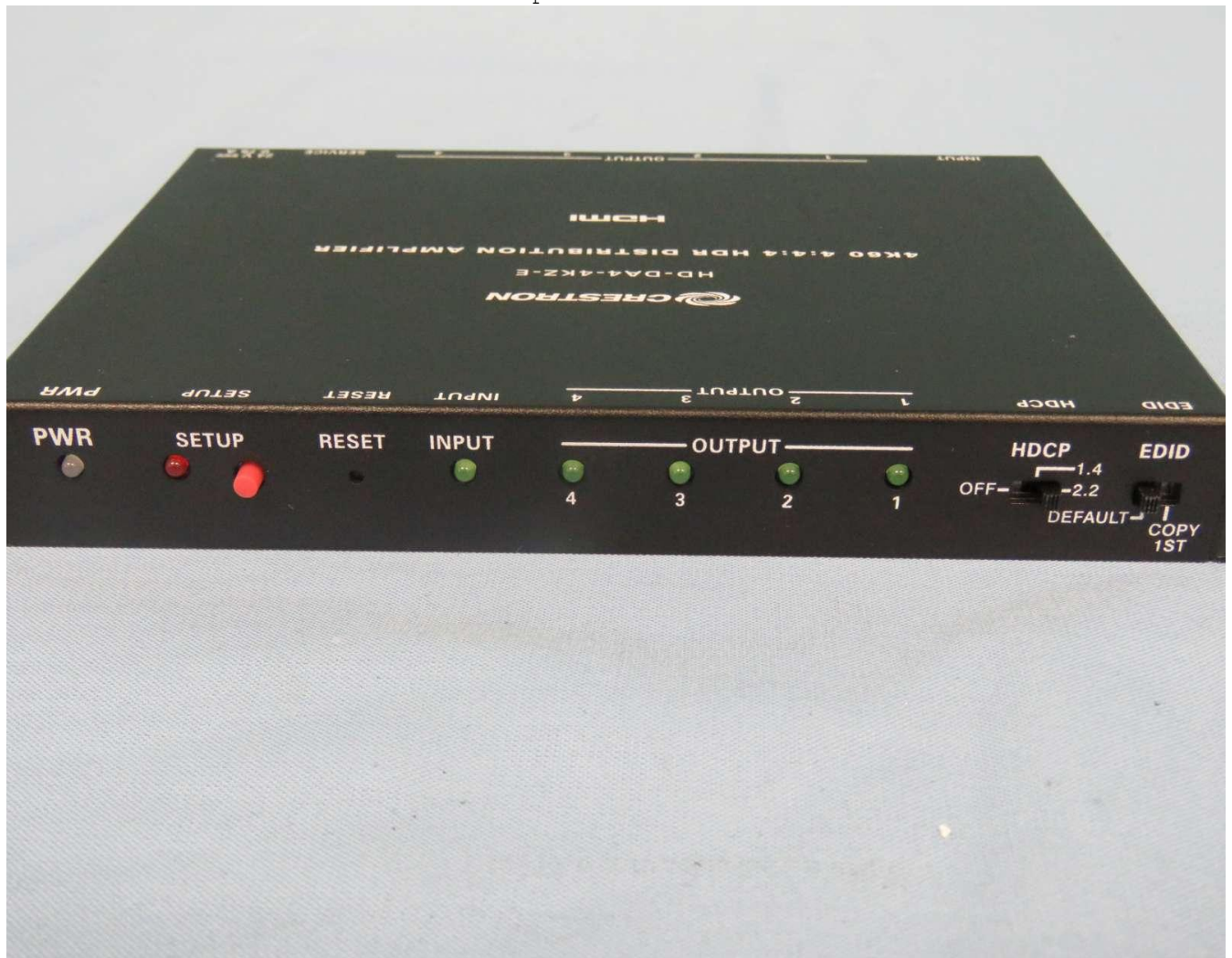

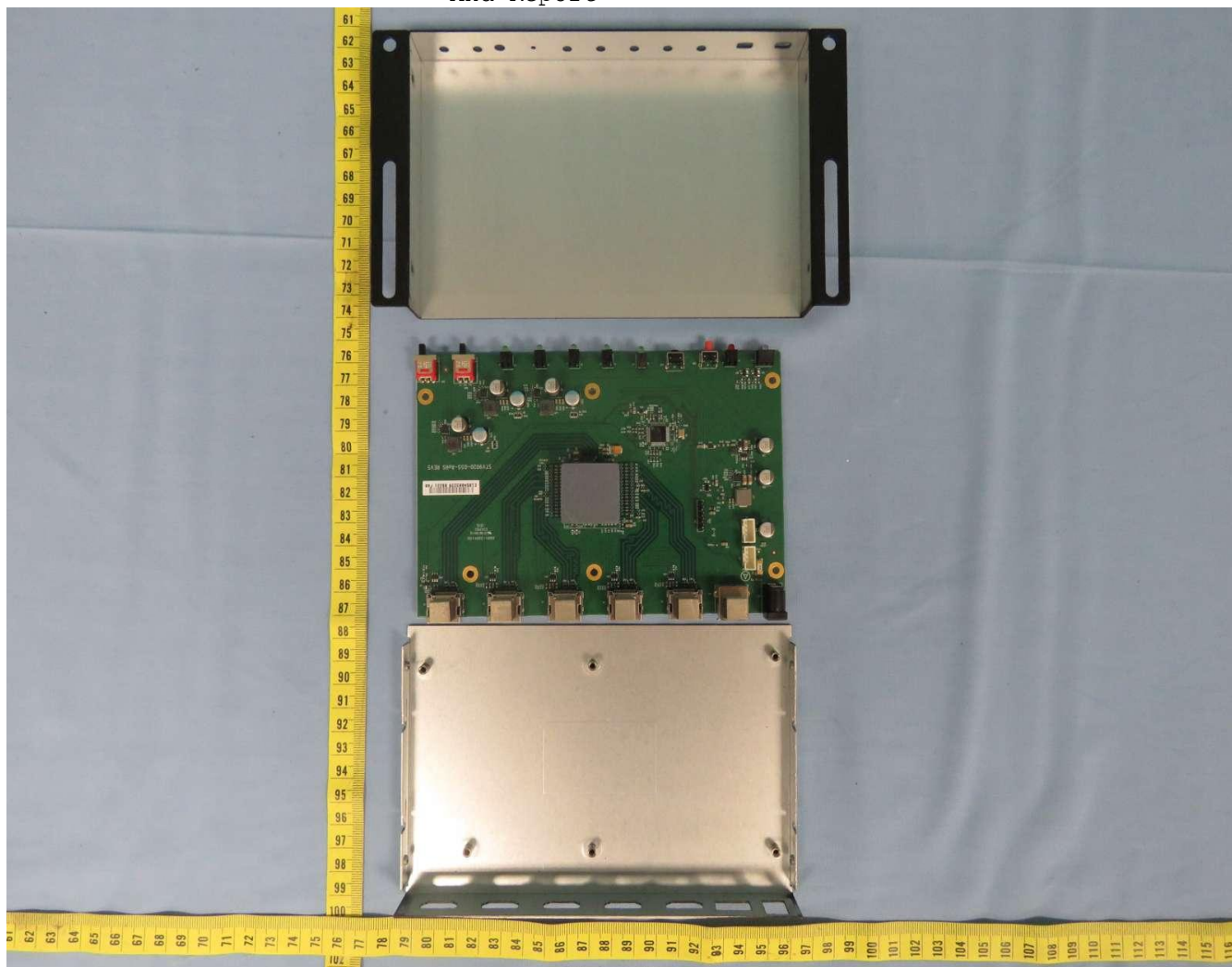



And Report

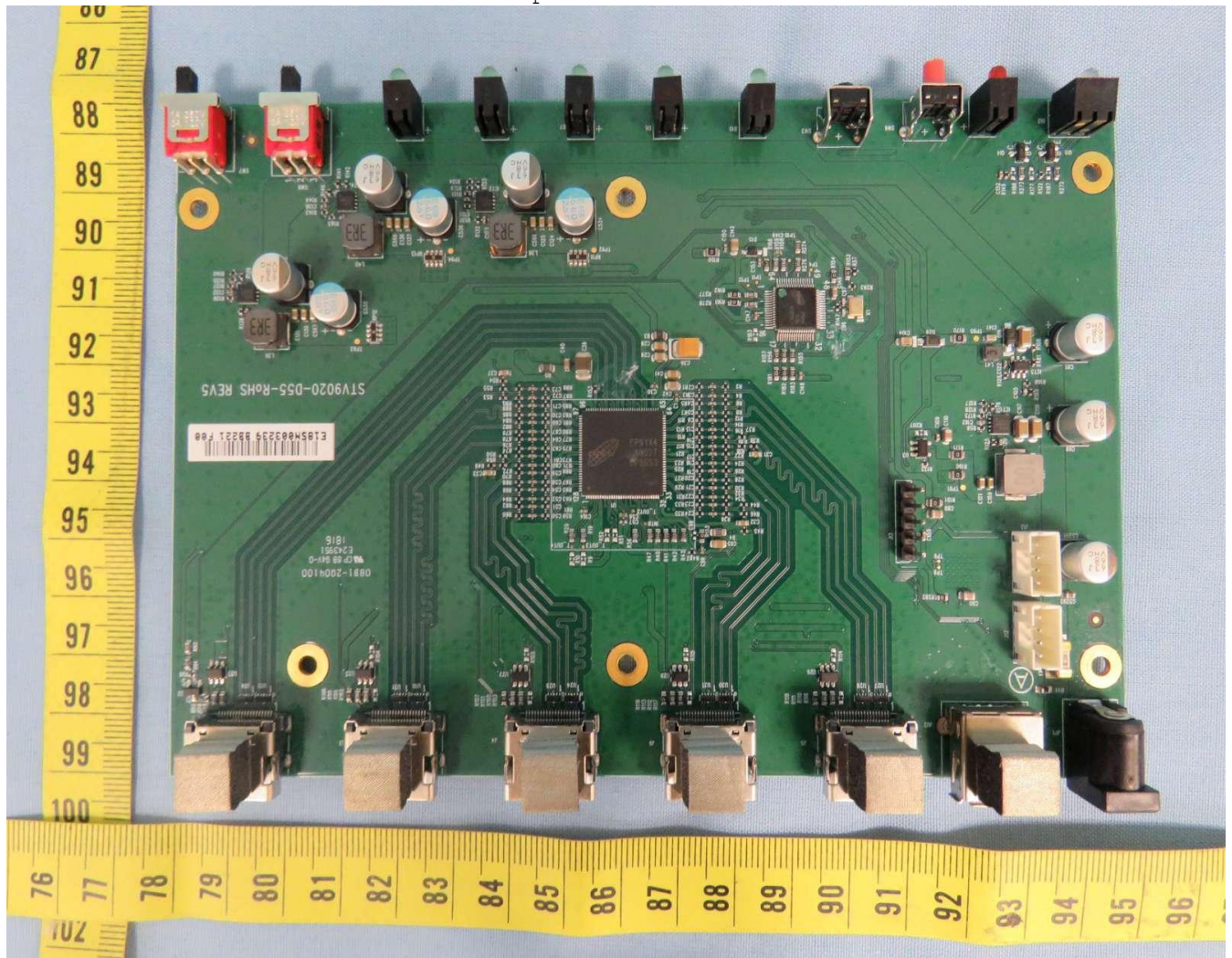

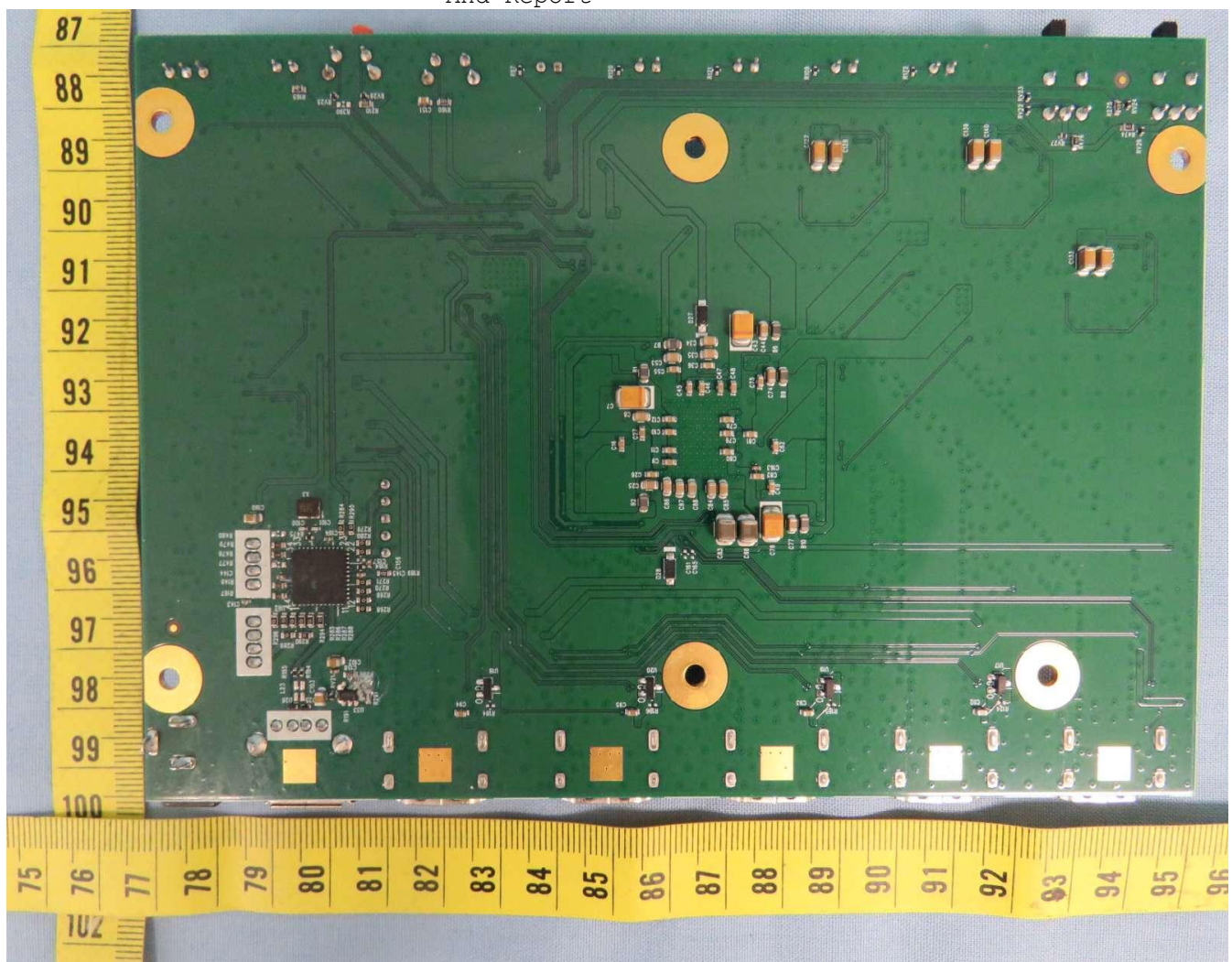

MATERIAL: Galvanized steel.

| REV | DESCRIPTION     | DRAWN     | DATE       |
|-----|-----------------|-----------|------------|
| 00  | INITIAL RELEASE | JACK CHEN | 2018/05/16 |

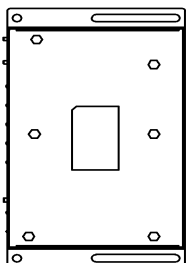
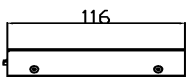
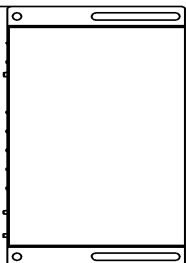
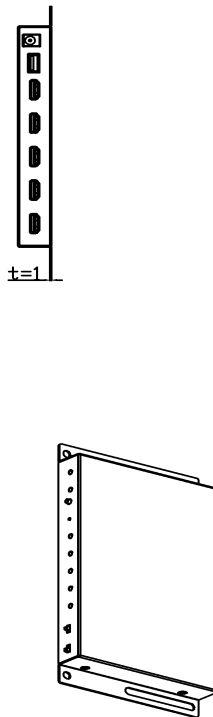

|   |  |                                       |                                      |
|---|--|---------------------------------------|--------------------------------------|
|   |  | <b>PART NO.:</b>                      |                                      |
| <b>UNLESS OTHERWISE SPECIFIED</b><br>DIMENSIONS ARE: MILLIMETERS<br>TOLERANCE ARE:<br>DIMENSION ± 0.20/0.081<br>ANGLES ± 1° |  | <b>PART NAME:</b><br>STV9020-ASSEMBLY |                                      |
| <b>APPROVED</b><br>CHECKED: JACK CHEN<br>DATE: 2018/05/16   | <b>DESIGNED</b><br>JACK CHEN<br>DATE: 2018/05/16 | <b>MODEL NO.:</b><br>STV9020-B55      | <b>DRAWING NO.:</b><br>STV9020-AS-00 |
| <b>DO NOT SCALE DRAWING</b>   |  | <b>THIRD ANGLE PROJECTION</b>         | <b>REV.:</b><br>SCALE: 1:1           |
| <b>SIZE:</b><br>A4  | <b>PCB TD:</b>                                   | <b>DATE:</b><br>2018/05/16            | <b>SHEET:</b><br>1 OF 1              |

# Race

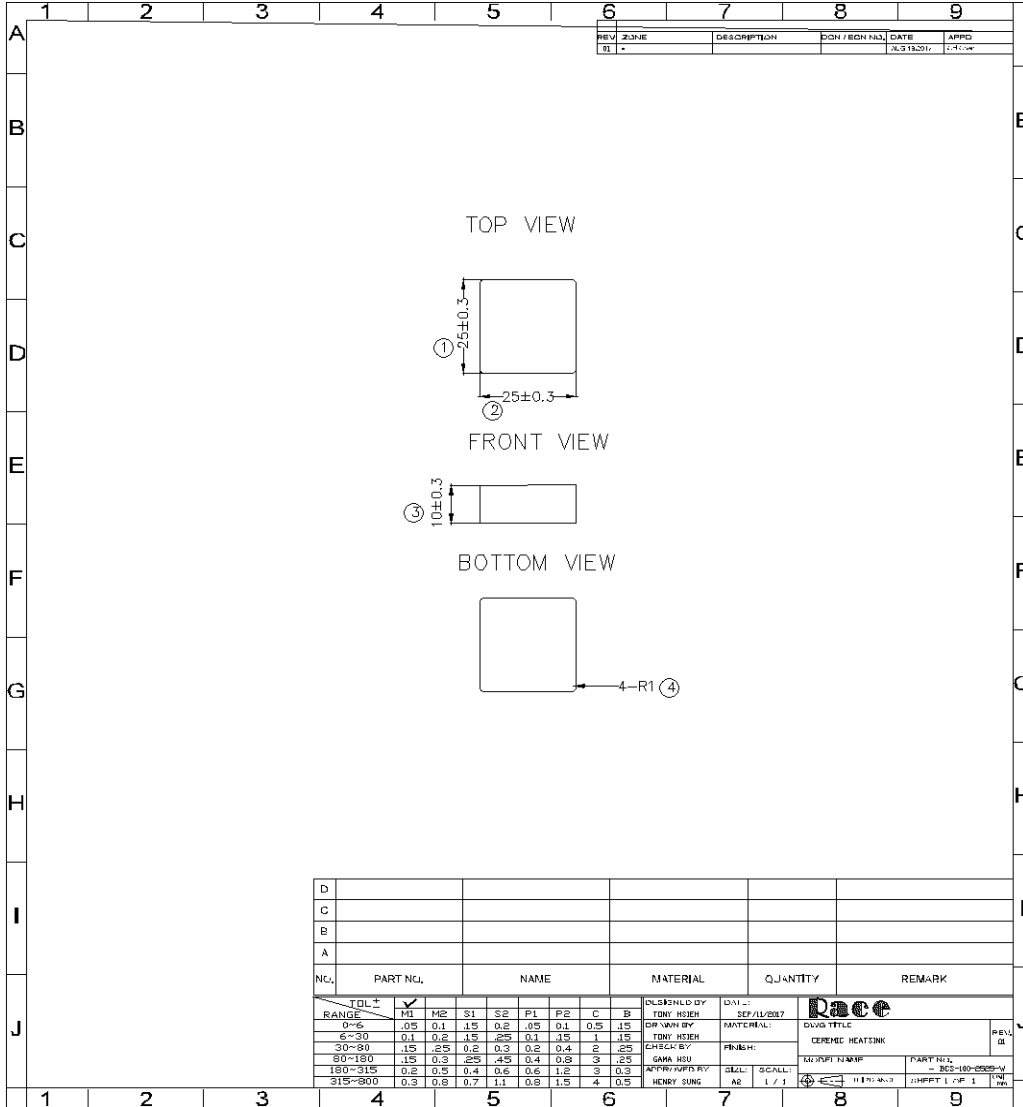



Quick Start

### HD-DA2-4KZ-E, HD-DA4-4KZ-E, and HD-DA8-4KZ-E 4K60 4:4:4 HDR Distribution Amplifiers

The HD-DA2-4KZ-E, HD-DA4-4KZ-E, and HD-DA8-4KZ-E distribution amplifiers split a single HDMI® signal to feed up to two, four, or eight displays and other device types, respectively. The distribution amplifiers support UHD and DCI 4K60 4:4:4 HDR video, HDCP 1.4 or 2.2 copy protection, and high-bitrate 7.1 audio. No control system is required for operation.

#### Check the Box

| Item   | Qty |
|--|-----|
| HD-DA2-4KZ-E, HD-DA4-4KZ-E, or HD-DA8-4KZ-E          | 1   |
| Power Pack, 24 Vdc 0.75 A, 100-240 Vac (P/N 2037209) | 1   |

#### Install the Device

The distribution amplifiers can be mounted onto drywall or onto a rack rail.

##### Drywall Mounting

Using four 8-18 x 3/4" modified truss head Phillips steel screws (not included), mount the device onto drywall.

##### Drywall Mounting (HD-DA2-4KZ-E Shown)

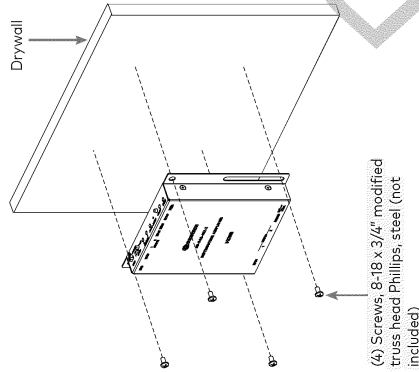

##### Rack Rail Mounting

Mount the device onto the front or rear rail of a rack. Position either the left or right mounting flange of the device so that the holes align with the holes in the rack. Then, secure the device to the rack using two rack mounting screws (not included). For more information, refer to the mounting instructions of the rack manufacturer.

##### Rack Rail Mounting (HD-DA2-4KZ-E Shown)

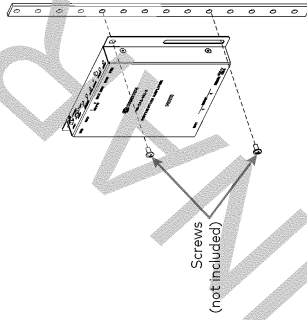

#### Connect the Device

Connect the rear panel of the device as required for the application.

##### Rear Panel Connections (HD-DA2-4KZ-E Shown)

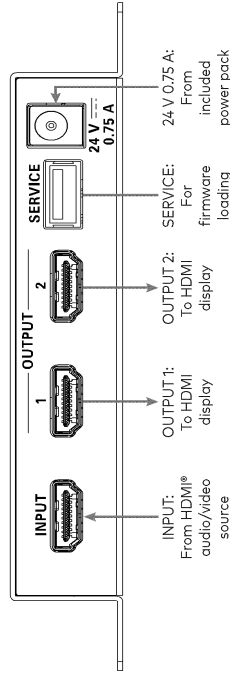

### ➤➤ Select the EDID Mode

Select the EDID (Extended Display Identification Data) mode by moving the EDID switch to either of the following positions:

- **DEFAULT:** (Default setting) The device sends a predefined Crestron EDID to the input device. The Crestron EDID supports 2-channel LPCM audio and 4K60 444 non-HDR video.
  - **COPY 1ST:** The device copies the EDID of the display connected to OUTPUT 1 and sends the EDID to the input device.
- NOTE: If the display that is connected to OUTPUT 1 is disconnected, the current EDID is retained. Connecting a different display to OUTPUT 1 does not automatically update the EDID at the input device. To update the EDID, move the EDID switch to the DEFAULT position and then back to the COPY 1ST position.

#### EDID Selection Switch (HD-DA2-4KZ-E Shown)

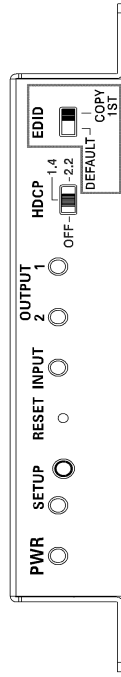

### ➤➤ Select the HDCP Version

Select the HDCP version by moving the HDCP switch to one of the following positions:

- **OFF:** Disables HDCP support
- **1.4:** Sets the HDCP version to 1.4
- **2.2:** (Default setting) Sets the HDCP version to 2.2

#### HDCP Selection Switch (HD-DA2-4KZ-E Shown)

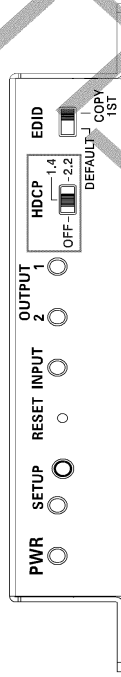

### ➤➤ Observe the LEDs

Observe the LEDs on the front panel of the device:

- **PWR:** Lights amber to indicate that the device is booting, and lights green to indicate that the device is powered on
- **INPUT:** Lights green to indicate that an HDMI signal is detected at the HDMI input transmitting an HDMI signal
- **OUTPUT 1-2, 1-4, or 1-8:** Lights green to indicate that the corresponding HDMI output is transmitting an HDMI signal

In addition to the LEDs listed above, a SETUP LED is also provided. When the SETUP button is pressed for 10 seconds, the SETUP LED flashes red ten times to indicate that the default settings have been restored.

#### Front Panel LEDs (HD-DA2-4KZ-E Shown)

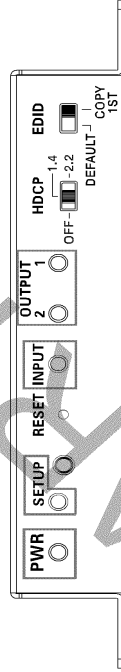

### ➤➤ Additional Information

Scan or click the QR code for detailed product information.



#### HDMI

### Compliance and Legal

This product is listed to applicable UL Standards and requirements tested by Underwriters Laboratories Inc. Ce produit est homologué selon les normes et les exigences UL applicables par Underwriters Laboratories Inc.



As of the date of manufacture, the product has been tested and found to comply with specifications for CE marking.



#### Federal Communications Commission (FCC) Compliance Statement

This device complies with part 15 of the FCC Rules. Operation is subject to the following conditions: (1) This device may not cause harmful interference and (2) this device must accept any interference received, including interference that may cause undesired operation.

CAUTION: Changes or modifications not expressly approved by the manufacturer responsible for compliance could void the user's authority to operate the equipment.

NOTE: This equipment has been tested and found to comply with the limits for a Class B digital device, pursuant to part 15 of the FCC Rules. These limits are designed to provide reasonable protection against harmful interference in a residential installation. This equipment generates, uses and can radiate radio frequency energy, and, if not installed and used in accordance with the instructions, may cause harmful interference to radio communications. However, there is no guarantee that interference will not occur in a particular installation. If this equipment does cause harmful interference to radio or television reception, which can be determined by turning the equipment off and on, the user is encouraged to try to correct the interference by one or more of the following measures:

- Reorient or relocate the receiving antenna.
- Increase the separation between the equipment and receiver.
- Connect the equipment into an outlet on a circuit different from that to which the receiver is connected.
- Consult the dealer or an experienced radio/TV technician for help.

#### Industry Canada (IC) Compliance Statement

CAN ICES-3(B)/NMB-3(B)

The product warranty can be found at [www.crestron.com/warranty](http://www.crestron.com/warranty). The specific patents that cover Crestron products are listed at [www.crestron.com/legal/patents](http://www.crestron.com/legal/patents).

Certain Crestron products contain open source software. For specific information, please visit [www.crestron.com/open-source](http://www.crestron.com/open-source).

Crestron and the Crestron logo are either trademarks or registered trademarks of Crestron Electronics, Inc. in the United States and/or other countries. HDMI and the HDMI logo are either trademarks or registered trademarks of HDMI Licensing LLC in the United States and/or other countries. UL and the UL logo are either trademarks or registered trademarks of Underwriters Laboratories, Inc. in the United States and/or other countries. Other trademarks, registered trademarks, and trade names may be used in this document to refer to either the entities claiming the marks and names or their products. Crestron disclaims any proprietary interest in the marks and names of others. Crestron is not responsible for errors in typography or photography.

©2018 Crestron Electronics, Inc.

**Crestron Electronics, Inc.**  
1500 Park Ave. Ste 100  
Ft. Lee, NJ 07647  
Tel: 201/767/7576  
Fax: 201/767/7576  
[www.crestron.com](http://www.crestron.com)

**Quick Start - Doc. 82768**  
**(205098)**  
**1018**  
Specifications subject to change without notice.

TEST RECORD NO. 1

SAMPLES:

The manufacturer submitted representative production samples of 1-to-4 4K HDMI Distribution Amplifier, Model HD-DA4-4KZ-E.

GENERAL:

Test results relate only to the items tested.

Unless otherwise noted, all clauses and tests were not considered necessary based upon previous evaluation under the CB scheme. The CB Scheme Test Certificate Ref. No. DK-77337-UL, dated 2018-10-16, and Report Ref. No. ATTCB107069, dated 2018-10-11 was prepared by UL (Demko).

The test methods and results of this investigation have been reviewed and found in accordance with the requirements in UL 62368-1, 2nd Edition, 2014-12-01 (Audio/video, Information and Communication Technology Equipment - Part 1: Safety Requirements), and CAN/CSA C22.2 No. 62368-1-14, 2nd Edition, 2014-12 (Audio/video, Information and Communication Technology Equipment - Part 1: Safety Requirements)

Test Record Summary:

The results of this investigation indicate that the products evaluated comply with the applicable requirements and, therefore, such products are judged eligible to bear UL's Mark as described on the Conclusion Page of this Report.

## CONCLUSION

Samples of the product covered by this Report have been found to comply with the requirements covering the category and the product is found to comply with UL's applicable requirements. The description and test result in this Report are only applicable to the sample(s) investigated by UL and does not signify UL certification or that the product(s) described are covered under UL's Follow-Up Service Program. When covered under UL's Follow-Up Service Program, the manufacturer is authorized to use the Certification Mark of UL on such products which comply with UL's Follow-Up Service Procedure and any other applicable requirements of UL LLC. The Certification Mark of UL on the product, or the UL symbol on the product and the Certification Mark of UL on the smallest unit container in which the product is packaged, is the only method to identify products investigated by UL to published requirements and manufactured under UL's Listing and Follow-Up Service.

This Report is intended solely for the use of UL LLC (UL) and the Applicant for establishment of UL certification coverage of the described product(s) under UL's Follow-Up Service. UL retains all rights, title and interest (including exclusive ownership) in this Report and all copyright therein. The Applicant or its designated agent shall not disclose or otherwise distribute this Report or its contents to any third party, except as required for purposes of compliance with laws, regulations, or other existing agreements or schemes in which UL is currently a participant. Any other use of this Report including, without limitation, evaluation or certification by a party other than UL is prohibited and renders the Report null and void. UL shall not incur any obligation or liability for any loss, expense, or punitive damages, arising out of, or in connection with, the use or reliance upon the contents of this Report to anyone other than the Applicant as provided in the agreement between UL and Applicant. Any use or reference to UL's name or certification mark(s) by anyone other than the Applicant in accordance with the agreement is prohibited without the express written approval of UL. Any information and documentation involving UL Mark services are provided on behalf of UL LLC (UL) or any authorized licensee of UL. Any information and documentation involving UL Mark services are provided on behalf of UL LLC (UL) or any authorized licensee of UL. UL shall not otherwise be responsible to anyone for the use of or reliance upon the contents of this Report.

Report by:

Winnie Su  
Project Engineer

Reviewed by:

Terence She  
Project Engineer