



**Description**

The Crestron® Zūm wall-box dimmer (ZUMMESH-DIM) provides control of dimmable magnetic low-voltage halogen or LED, incandescent, and tungsten-halogen loads. It features a single rocker switch to enable simple on/off switching and dimming adjustment, with the ability to save one preset.

**Zūm Overview**

A Zūm space consists of one space, such as a board room or conference room, that is equipped with Zūm mesh devices. The Zūm mesh devices (i.e., dimmers, switches, keypads, and sensors) in the space provide control and communicate directly with each other without the need for a centralized gateway or processor.

If expanded functionality of the Zūm space is desired, a ZUMMESH-NETBRIDGE (not included) can be added which provides centralized control and monitoring from a Crestron control system (not included).

**NOTE:** The ZUMMESH-NETBRIDGE requires a compatible J-box device (not included) to provide power.

**Additional Resources**

Visit the product page on the Crestron website ([www.crestron.com](http://www.crestron.com)) for additional information and the latest firmware updates. Use a QR reader application on your mobile device to scan the QR image.



**Important Notes**

**WARNING:** To avoid fire, shock, or death, turn off the power at the circuit breaker or fuse and test that the power is off before wiring!

**NOTE:** Observe the following points.

- Neutral: The ZUMMESH-DIM requires a neutral connection to operate.
- Codes: Install in accordance with all local and national electrical codes.
- Installation: A qualified electrician should install this product.
- Wiring: Use copper wire only. For supply connections, use wire rated for at least 75 °C.
- Temperature: For use where temperatures are between 32° to 104 °F (0° to 40 °C).
- Electrical Boxes: Devices mount in standard electrical boxes. For easy installation, Crestron recommends using 3-1/2 in (89 mm) deep electrical boxes. Several devices can be installed in one electrical box (multigang). For a smooth appearance, one-piece multigang faceplates (not supplied) can be installed.
- Switches: Mechanical 3- or 4-way switches do not work with the ZUMMESH-DIM.
- Spacing: If mounting one device above another, leave at least 4-1/2 in (115 mm) vertical space between them.
- Low-voltage Applications: Operation of a low-voltage circuit with all lamps inoperative or removed may result in current flow in excess of normal levels. For protection against transformer overheating and premature transformer failure, Crestron recommends the following:
  - > Do not operate low-voltage circuits without operative lamps in place.
  - > Replace burned-out lamps as quickly as possible.
  - > Use transformers that incorporate thermal protection to prevent transformer failure due to overcurrent.

**Installation**

**WARNING:** Turn off the power at the circuit breaker. Installing with power on can result in serious personal injury and damage to the device.

To install the ZUMMESH-DIM, do the following.

1. Turn the power off at the circuit breaker.
2. Wire the device as shown in the following diagram.

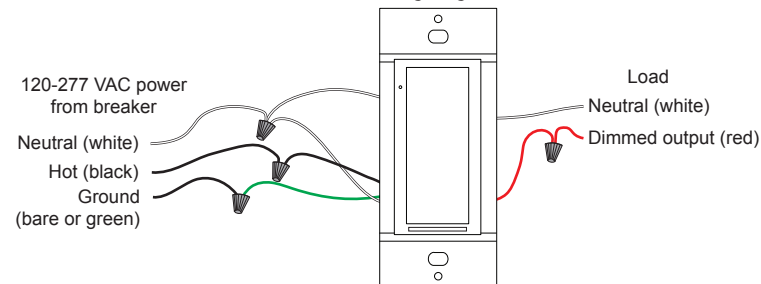

3. Push all power wires back into the electrical box and fasten the device to the electrical box with the provided screws.
4. Attach the faceplate (not included).
5. Restore the power at the circuit breaker.

**Multigang Installations**

In multigang installations, several devices are grouped horizontally in one electrical box. For a smooth appearance, a one-piece multigang faceplate (not included) can be installed.

**NOTE:** When installing into a multigang box, do not fully tighten devices to the box until the faceplate has been aligned.

**NOTE:** Devices will not mount within a 2-gang mud ring. Use a standard 2-gang box.

The load capacity for each device in the electrical box must be derated. Refer to the following diagrams for derating information. The VA ratings are for input power to the transformer. If the input power requirement of the transformer is unknown, use the bulb's wattage rating to determine proper rating.

**Derating Information for ZUMMESH-DIM at 120 V**

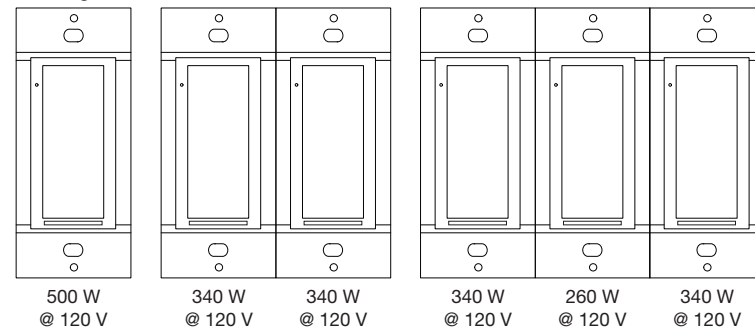

**Derating Information for ZUMMESH-DIM at 277 V**

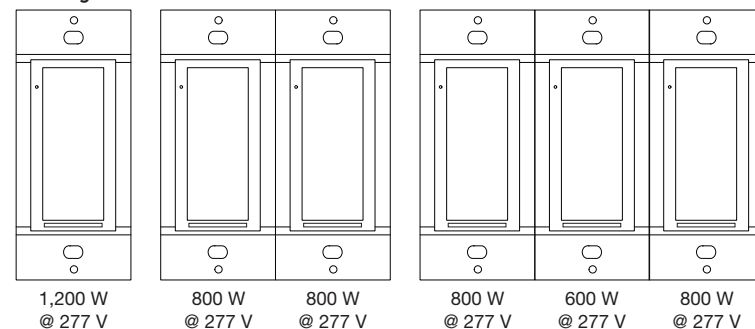

**Operation**

The ZUMMESH-DIM functions as described below.

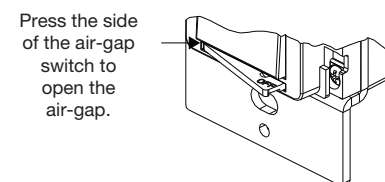
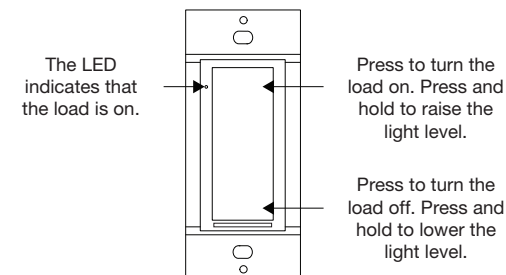

**How to Set Up a Zūm Space and Add Zūm Devices**

Once all devices are physically installed in a board room or conference space, a new Zūm space can be created and devices added.

**NOTE:** Only set up one Zūm space at a time.

**NOTE:** For simplified setup of a Zūm space, use the Zūm app on a mobile device.

**Step 1 Create a New Zūm Space**

Creating a Zūm space defines the area where the devices are located, such as a board room or conference room. A Zūm space is created with a keypad, dimmer or switch, a J-box device, or an AV Bridge.

**NOTE:** Creating a Zūm space can only be performed by one device in the space.

**NOTE:** A Zūm space cannot be created from a battery-powered keypad.

**To create a new Zūm space using a keypad, dimmer, or switch:**

1. Press the bottom button 5 times.
2. Press and hold the button until the LED on the device lights (about 10 seconds). After approximately 3 seconds, the device LED begins slowly flashing. This indicates that the Zūm space is now created and in Joining mode, allowing you to add devices.

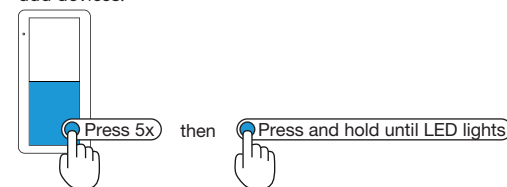

**To create a new Zūm space using a J-box device or an AV Bridge:**

1. Press the **Setup** button 5 times.
2. Press and hold the **Setup** button until the LED on the device lights (about 10 seconds). After approximately 3 seconds, the device LED begins slowly flashing. This indicates that the Zūm space is now created and in Joining mode, allowing you to add devices.

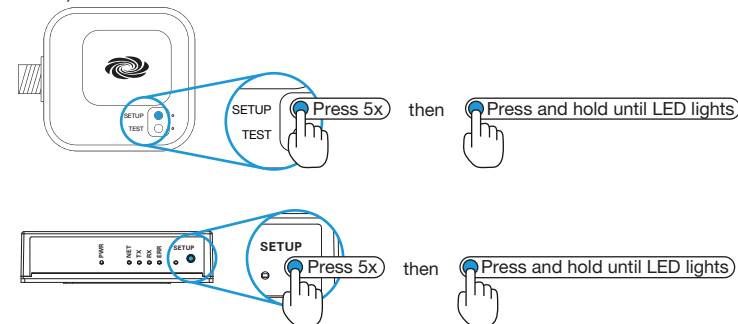

**NOTE:** The device that is used to create the Zūm space is automatically added to the space and does not need to be added in Step 2.

**Step 2 Add the ZUMMESH-DIM to the Zūm Space**

After a new Zūm space is created, add the ZUMMESH-DIM while the space is in Joining mode.

**NOTE:** A Zūm mesh device can belong to only one space.

**NOTE:** Joining mode ends automatically after 4 minutes.

To add the ZUMMESH-DIM:

1. Press the top button 3 times.
2. Press and hold the button until the LED on the ZUMMESH-DIM lights (up to 10 seconds). The LED on the ZUMMESH-DIM will start to flash slowly to indicate that it has joined the space.

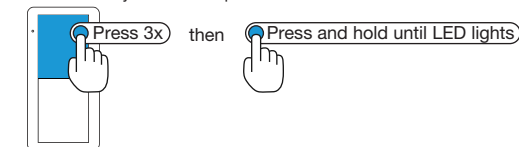

**Step 3 Complete Zūm Space Setup**

To finish creating a Zūm space, press any button on a device that is part of the Zūm space to exit Joining mode.

**Add the ZUMMESH-DIM to an Existing Zūm Space**

Add the ZUMMESH-DIM to an existing Zūm space by placing the Zūm space in Joining mode.

**Add the ZUMMESH-DIM using a keypad, dimmer, or switch:**

1. Enter Joining mode.
  - a. Press and hold both the top and bottom buttons until the LED lights (about 5 seconds).
  - b. Press the top button once.
  - c. Press the bottom button once. The LEDs on all devices in the space (except battery powered devices) flash slowly to indicate that the devices are part of the space and that the space is in Joining mode.

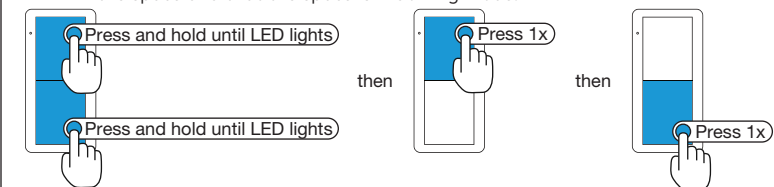

2. Add the ZUMMESH-DIM.
  - a. Press the top button 3 times.
  - b. Press and hold the button until the LED on the ZUMMESH-DIM lights (up to 10 seconds). The LED on the ZUMMESH-DIM will start to flash slowly to indicate that it has joined the space.

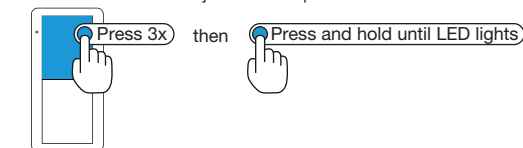

3. Press any button on a device that is part of the Zūm space to exit Joining mode.

**Add the ZUMMESH-DIM using a J-box device:**

1. Enter Joining mode.
  - a. Press the **SETUP** button 2 times.
  - b. Press the **TEST** button once. The LEDs on all devices in the space (except battery powered devices) flash slowly to indicate that the devices are part of the space and that the space is in Joining mode.

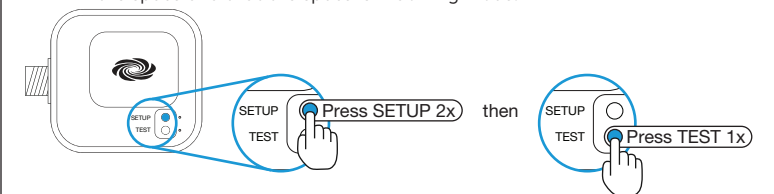

2. Add the ZUMMESH-DIM.
  - a. Press the top button 3 times.
  - b. Press and hold the button until the LED on the ZUMMESH-DIM lights (up to 10 seconds). The LED on the ZUMMESH-DIM will start to flash slowly to indicate that it has joined the space.

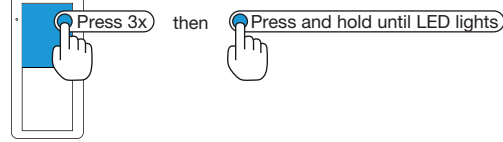

3. Press any button on a device that is part of the Züm space to exit Joining mode.

### Customize Local Scenes

When pressed, the top button on the ZUMMESH-DIM recalls Scene 1 (90% load level). The light levels for the scene can be adjusted to match the needs in the space.

To customize Scene 1:

1. Enter Scene Setting mode.
  - a. Press and hold both the top and bottom buttons of the dimmer until the LED lights (about 5 seconds).
  - b. Press the top button two times.
  - c. Press the bottom button once. The LED on the dimmer flashes its LED two times every two seconds. Load controllers that are bound to the keypad flash their LED rapidly.

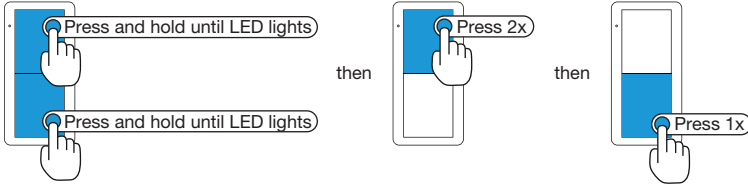

2. Adjust the lights in the room by pressing and holding the top button to raise the light level or the bottom button to lower the level.
3. Press the bottom button on the keypad 3 times to exit Scene Setting mode.

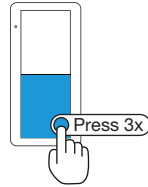

### Factory Reset

Perform a factory reset when the device is removed from the network or to remove the configuration settings. The device must also be factory reset if the device is being moved to a different system.

**NOTE:** New-in-box devices do not need to be factory reset before joining a system.

To factory reset the ZUMMESH-DIM:

1. Press and hold the top and bottom buttons until the LED lights (about 5 seconds).
2. Press and hold the bottom button until the LED lights (about 10 seconds).

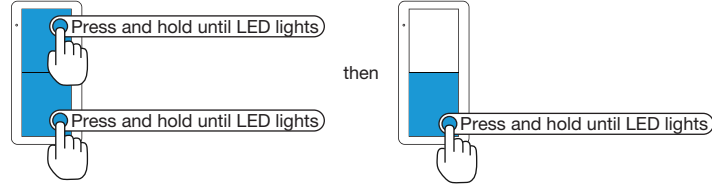

### Troubleshooting

The following provides corrective actions for possible trouble situations. If further assistance is required, please contact a Crestron customer service representative.

TROUBLE	POSSIBLE CAUSE(S)	ACTION
When lowering the light level, the lower button must be held for more than a few seconds before the light begins to dim.	The load has significant dead travel.	Adjust the Max level using the Crestron Züm app.
The light flickers when dimmed to a low level.	The load is being dimmed below its Min level.	Adjust the Min level using the Crestron Züm app.
	The load is not compatible with conventional forward-phase dimming.	For electronic loads, consider using the ZUMMESH-DELV.
The light glows even when the dimmer is off.	There is a small amount of leakage current through the dimmer.	For electronic loads, consider using the ZUMMESH-DELV.
The light does not turn on even though the green LED on the dimmer is on.	There is a short or open circuit on the output of the dimmer.	Verify the load wiring.
The dimmer does not function.	The air-gap switch is open.	Verify that the air-gap switch is fully closed.
	There is no dedicated neutral on the circuit.	Ensure that the dimmer is wired with a dedicated neutral.
	There is no power on the circuit.	Check the breaker.

### Specifications

The specifications for the dimmer are listed below.

SPECIFICATION	DETAILS
Load Control	
Dimmable Load Types	Incandescent, tungsten-halogen, magnetic low-voltage (MLV transformer for halogen or LED)
Line/Load Voltage	120-277 VAC, 50/60 Hz, dedicated neutral wire required
Minimum Load	25 W
Load Rating	500 W maximum @ 120 VAC; 1200 W maximum @ 277 VAC; Refer to the "Multigang Installation" section for derating information
Environmental	
Temperature	32° to 104 °F (0° to 40 °C)
Humidity	10% to 90% RH (noncondensing)
Enclosure	1-gang mountable in a 3-1/2 in (89 mm) deep electrical box; Requires decorator-style faceplate (not included)

This product conforms to UL® STD 1472; certified to CSA STD C22.2 No. 184.1 tested by Intertek.



#### Federal Communications Commission (FCC) Compliance Statement

This device complies with part 15 of the FCC Rules. Operation is subject to the following two conditions: (1) This device may not cause harmful interference, and (2) this device must accept any interference received, including interference that may cause undesired operation.

**CAUTION:** Changes or modifications not expressly approved by the manufacturer responsible for compliance could void the user's authority to operate the equipment.

**NOTE:** This equipment has been tested and found to comply with the limits for a Class A digital device, pursuant to part 15 of the FCC Rules. These limits are designed to provide reasonable protection against harmful interference when the equipment is operated in a commercial environment. This equipment generates, uses, and can radiate radio frequency energy and, if not installed and used in accordance with the instruction manual, may cause harmful interference to radio communications. Operation of this equipment in a residential area is likely to cause harmful interference in which case the user will be required to correct the interference at his own expense.

#### Industry Canada (IC) Compliance Statement

CAN ICES-3(A)/NMB-3(A)

The product warranty can be found at [www.crestron.com/warranty](http://www.crestron.com/warranty).

The specific patents that cover Crestron products are listed at [www.crestron.com/legal/patents](http://www.crestron.com/legal/patents). Certain Crestron products contain open source software. For specific information, please visit [www.crestron.com/opensource](http://www.crestron.com/opensource).

Crestron, the Crestron logo, and Züm are either trademarks or registered trademarks of Crestron Electronics, Inc. in the United States and/or other countries. UL and the UL logo are either trademarks or registered trademarks of Underwriters Laboratories, Inc. in the United States and/or other countries. Other trademarks, registered trademarks, and trade names may be used in this document to refer to either the entities claiming the marks and names or

their products. Crestron disclaims any proprietary interest in the marks and names of others. Crestron is not responsible for errors in typography or photography.

This document was written by the Technical Publications department at Crestron. ©2018 Crestron Electronics, Inc.

**Crestron Electronics, Inc.**  
15 Volvo Drive, Rockleigh, NJ 07647  
Tel: 888.CRESTRON  
Fax: 201.767.7576  
[www.crestron.com](http://www.crestron.com)

**Installation Guide - DOC. 8201B**

(2048928)

04.18

Specifications subject to change without notice.