

Crestron **Adagio**[®] AMS
Media System

Operations Guide



This document was prepared and written by the Technical Documentation department at:



Crestron Electronics, Inc.
15 Volvo Drive
Rockleigh, NJ 07647
1-888-CRESTRON

Important Safety Instructions

- Read these instructions.
- Keep these instructions.
- Heed all warnings.
- Follow all instructions.
- Do not use this apparatus near water.
- Clean only with dry cloth.
- Do not block any ventilation openings. Install in accordance with the manufacturer's instructions.
- Do not install near any heat sources such as radiators, heat registers, stoves, or other apparatus (including amplifiers) that produce heat.
- Do not defeat the safety purpose of the polarized or grounding-type plug. A polarized plug has two blades with one wider than the other. A grounding-type plug has two blades and a third grounding prong. The wide blade or the third prong are provided for your safety. If the provided plug does not fit into your outlet, consult an electrician for replacement of the obsolete outlet.
- Protect the power cord from being walked on or pinched particularly at plugs, convenience receptacles, and the point where they exit from the apparatus.
- Only use attachments/accessories specified by the manufacturer.
- Unplug this apparatus during lightning storms or when unused for long periods of time.
- Refer all servicing to qualified service personnel. Servicing is required when the apparatus has been damaged in any way, such as power-supply cord or plug is damaged, liquid has been spilled or objects have fallen into the apparatus, the apparatus has been exposed to rain or moisture, does not operate normally, or has been dropped.
- Disconnect power prior to connecting or disconnecting equipment.
- Do not install in direct sunlight.
- The apparatus must be installed in a way that the power cord can be removed either from the wall outlet or from the device itself in order to disconnect the mains power.
- Prevent foreign objects from entering the device.

WARNING:

TO REDUCE THE RISK OF FIRE OR ELECTRIC SHOCK, DO NOT EXPOSE THIS APPARATUS TO RAIN OR MOISTURE. THE APPARATUS SHALL NOT BE EXPOSED TO DRIPPING OR SPLASHING. OBJECTS FILLED WITH LIQUIDS, SUCH AS VASES, SHOULD NOT BE PLACED ON THE APPARATUS.

WARNING:

TO PREVENT ELECTRIC SHOCK, DO NOT REMOVE COVER. THERE ARE NO USER SERVICEABLE PARTS INSIDE. ONLY QUALIFIED SERVICE PERSONNEL SHOULD PERFORM SERVICE.



The lightning flash with arrowhead symbol, within an equilateral triangle, is intended to alert the user to the presence of uninsulated "dangerous voltage" within the product's enclosure that may be of sufficient magnitude to constitute a risk of electric shock to persons.



The exclamation point within an equilateral triangle is intended to alert the user to the presence of important operating and maintenance (servicing) instructions in the literature accompanying the appliance.

WARNING:

THIS IS AN APPARATUS WITH CLASS I CONSTRUCTION. IT SHALL BE CONNECTED TO AN ELECTRICAL OUTLET WITH AN EARTHING GROUND TERMINAL.

IMPORTANT:

The AMS can be used with Class 2 output wiring.

Contents

Media System: Adagio AMS	1
Introduction	1
Features and Functions	1
7.1 Surround Sound.....	2
High-End Audio Performance.....	2
Audyssey MultEQ® XT.....	2
AV Inputs and Outputs.....	2
High Definition Multimedia Interface (HDMI™) Technology.....	2
Multi-Room Audio.....	2
2-Channel Steering.....	3
Satellite Radio	3
Audio Servers.....	3
Enhanced Front Panel Control	3
Versatile Room Controls.....	3
2-Series Ethernet Control System	4
Home Automation and Integration.....	4
Applications.....	4
Specifications	5
Physical Description	9
Industry Compliance	19
Setup	20
Network Wiring.....	20
Hardware Hookup	20
Configuration	41
Configure the AMS for Operation.....	41
Open Installer Tools	41
Select Tuner Format	42
Configure the Network.....	42
Configure the Theater	43
Configure Distributed Audio.....	48
Identify Keypads	55
Load APADs	57
About.....	57
Configure Sources	58
Configure Rooms	58
Configure Theater.....	61
Configure Preset Groups	62
Operation	65
Theater Mode	65
Source Mode.....	69
Controlling a Tuner	69
Controlling an iPod or iPhone.....	84
Controlling an Adagio Audio Server (AAS)	87
Route a Source	92
Room Mode.....	92
Party Mode and Other Room Groups	95

Lock and Unlock the Front Panel Controls	96
Turn off the Theater.....	96
Turn off the System.....	96
Programming Software.....	97
Earliest Version Software Requirements for the PC	97
Programming with Adagio Composer.....	97
Programming with Crestron SystemBuilder.....	97
Programming with SIMPL Windows	98
Programming with VisionTools Pro-e.....	98
Configuring the AMS.....	98
Switching Programs.....	99
Saving Settings.....	99
Example Program	99
Uploading and Upgrading.....	100
Establishing Communication.....	100
Programs and Firmware	101
Problem Solving	103
Troubleshooting.....	103
Check Network Wiring.....	104
Reference Documents.....	105
Further Inquiries	105
Future Updates	105
Software License Agreement.....	106
Return and Warranty Policies.....	108
Merchandise Returns / Repair Service	108
CRESTRON Limited Warranty.....	108
Trademark Information	109
Windows	109
XM	109
SIRIUS	109
iPod	109
HDMI.....	109
Dolby.....	109
DTS	109
Audyssey.....	109

Media System: Adagio AMS

Introduction

Features and Functions

- Integrated surround sound processor and amplifier
- Out-of-the-box functionality (no programming required):
 - ⇒ Audio distribution for four to six rooms; expandable to 12 rooms when used with Adagio Audio Expander (AAE)
 - ⇒ Control from front panel or any combination of six (up to 12 if used with AAE) APAD LCD controllers or C2N-DBF12 12-button room keypads
 - ⇒ Built-in support for (2) optional ATC tuner cards, (1) Interface for Apple iPod® (CEN-IDOC)¹, (1) AAE and (1) Adagio Audio Server (AAS)¹
- Audyssey MultEQ® XT advanced automatic equalization
- High-definition analog and HDMI digital video switching
- Audio distribution for four to six rooms, expandable to 24 rooms with additional Adagio Audio Expanders
- Control audio functions from the built-in LCD-driven front panel, 12-button room keypads, or APAD LCD controllers. Other control devices can be used with additional programming
- Accepts up to three (optional) dual radio tuner cards for XM² and SIRIUS³ Satellite Radio, and AM/FM radio with RDS/RBDS (one tuner card included)
- Room Grouping function allows easy routing of one source to multiple rooms at once
- Plug-and-play support for Adagio Audio Servers (AAS-1, AAS-2, AAS-4)¹ and Interface for Apple iPod (CEN-IDOC)¹
- Set up via front panel or software
- 2-Series Ethernet control system — programmable to support Crestron® touchpanels, wireless remotes, lighting dimmers, thermostats, and much more!

1. DHCP Ethernet router required.
2. Hardware and required basic monthly subscription sold separately. Premium Channel available at additional monthly cost. Installation costs and other fees and taxes, including a one-time activation fee may apply. Subscription fee is consumer only. All fees and programming subject to change. Subscriptions subject to Customer Agreement available at xmradio.com. Only available in the 48 contiguous United States. ©2008 XM Satellite Radio Inc. All rights reserved. All other trademarks are the property of their respective owners.
3. Sirius Satellite Radio subscription, sold separately. © SIRIUS Satellite Radio Inc. "SIRIUS" and the SIRIUS dog logo are registered trademarks of SIRIUS Satellite Radio Inc.

7.1 Surround Sound

The AMS features a surround sound processor and 7-channel amplifier designed for use with digital and analog audio sources. Dolby® Digital EX and DTS-ES Neo:6 96/24 decoding provides excellent sound quality from DVD video and audio titles, with a full set of decoding and processing modes available to enhance the vast range of movies and music available.



High-End Audio Performance

With 7x100 Watts of amplification and a discrete subwoofer/LFE balanced line output, the AMS can drive any 5.1, 6.1, or 7.1 theater speaker system with powered subwoofer. A Class G amplifier topology produces the sound of a Class AB design with near-digital efficiency. A six-band parametric EQ is provided on each output channel including the subwoofer/LFE output with time-delay (up to 100 ms per channel) for proper lip-sync and speaker placement compensation.

Audyssey MultEQ® XT

Audyssey MultEQ XT facilitates an optimum listening experience for every seat in your theater using an equalization solution that corrects for both time and frequency response problems. MultEQ XT accurately measures sound response throughout the listening area, and combines that information to accurately represent the acoustical problems in the room. Based on these measurements, MultEQ XT calculates an equalization solution that effectively minimizes response distortion at every listening position.



AV Inputs and Outputs

The AMS supplies a total of 10 S/PDIF digital audio inputs, three HDMI inputs, 10 analog stereo inputs, and one analog 7.1 surround input. In addition to its speaker and subwoofer outputs, the AMS has unbalanced line-level audio outputs containing the 7.1 surround signal as well as a stereo downmix signal. High-definition video switching is also provided for eight HDTV/component, four S-video, four composite, and three HDMI sources.

High Definition Multimedia Interface (HDMI™) Technology

The AMS's HDMI inputs and output provide quick connectivity for high-end components, providing a single-cable digital interface that combines uncompressed high-definition video, multi-channel audio, and intelligent format and command data. HDMI switching supports the routing of DVD and DTV sources to a single HDTV display up to 1080p, and can decode digital audio signals from DVD-Audio, SACD, Dolby Digital and DTS sources.

Multi-Room Audio

In addition to surround sound in the home theater, the AMS also distributes stereo audio to several pairs of remote room speakers. Listeners in each room can enjoy their own choice of radio stations, CDs and MP3s, or even a stereo downmix of the surround sound output. Each room includes its own volume, bass, and treble

controls, with the ability to combine a group of rooms easily at the press of the "Party Mode" button. With additional programming, the AMS can also be configured with five other room groups (in addition to the *Party* mode).

The integrated multi-room amplifier delivers 45 watts per channel to each of four rooms. A fifth stereo room, or up to two mono rooms, can be supported using spare surround channels if the theater is configured as 6.1, 5.1, or lower.

Without any programming, the AMS can be expanded to support another six rooms by adding an AAE Audio Expander. With Crestron Adagio Composer software, a total of three AAEs can be added, supporting up to 24 rooms in all (plus the theater).

2-Channel Steering

For homes that combine their theater with their main living space, some additional signal routing flexibility is needed. Listening to stereo music through the theater's main front speakers can have a distracting effect when there's music playing throughout the house. With 2-channel and multi-channel steering capability, the AMS lets you listen through the theater's side or rear speakers instead of, or in addition to, the front speakers for the most cohesive whole-house listening experience.

Satellite Radio

Up to three dual radio tuner cards can be installed in the AMS to enable combinations of up to six AM/FM, XM and SIRIUS® Satellite Radio tuners, letting listeners in different rooms enjoy their own choice of music, news, sports and talk. For satellite and many FM stations, the AMS displays data such as the radio station name, song and artist, traffic, weather, and phone numbers. The AMS comes with one tuner card included.

Audio Servers

Plug-and-play compatibility with Crestron's AAS Adagio Audio Server and CEN-IDOC Interface for Apple iPod® delivers instant access to an entire collection of music from any room in the house with the ability to browse by album, artist, or song title.

Enhanced Front Panel Control

With its large backlit LCD display, room and preset buttons, four soft buttons, and dual rotary encoders, the AMS front panel provides a very powerful, yet friendly user interface for setting up and controlling the theater along with a houseful of speakers. Custom naming of rooms, groups, and sources is performed on the LCD display, and also on the custom label strip using Crestron Engraver software. A selection of pre-made labels is also included.

Versatile Room Controls

A choice of basic 12-button keypads or the advanced APAD Wall Mount LCD Controller enables versatile control of the AMS in every room. A keypad provides the essential controls for adjusting volume, selecting sources, and switching tracks and radio channels. For more elegant control, the APAD extends the many functions of the AMS front panel to each room, displaying audio source names, radio stations, CD titles, artists, and tracks, audio settings and many other parameters.

2-Series Ethernet Control System

At the heart of the AMS is the powerful 2-Series control engine. With both Cresnet and Ethernet connectivity, plus custom programmability using Crestron SystemBuilder™ software, the AMS allows nearly limitless expansion and customization using Crestron's entire line of touchpanels, wireless remotes, and hundreds of other devices. The built-in Web server with native e-Control®2 XPanel support enables full remote control over IP from computers and PDA devices, as well as remote diagnostics and updates. Built-in IR, RS-232, relay and digital input ports are included to interface the AMS with non-Crestron devices ranging from CD changers to security systems.

Home Automation and Integration

The AMS can grow as part of a complete home automation solution supporting all of Crestron's Cresnet and infiNET™ controllable dimmers, shade controllers, thermostats, and other devices.

Applications

The following diagram shows an AMS as the centerpiece of an Adagio system using out-of-the-box functionality.

AMS as the Centerpiece of an Adagio System

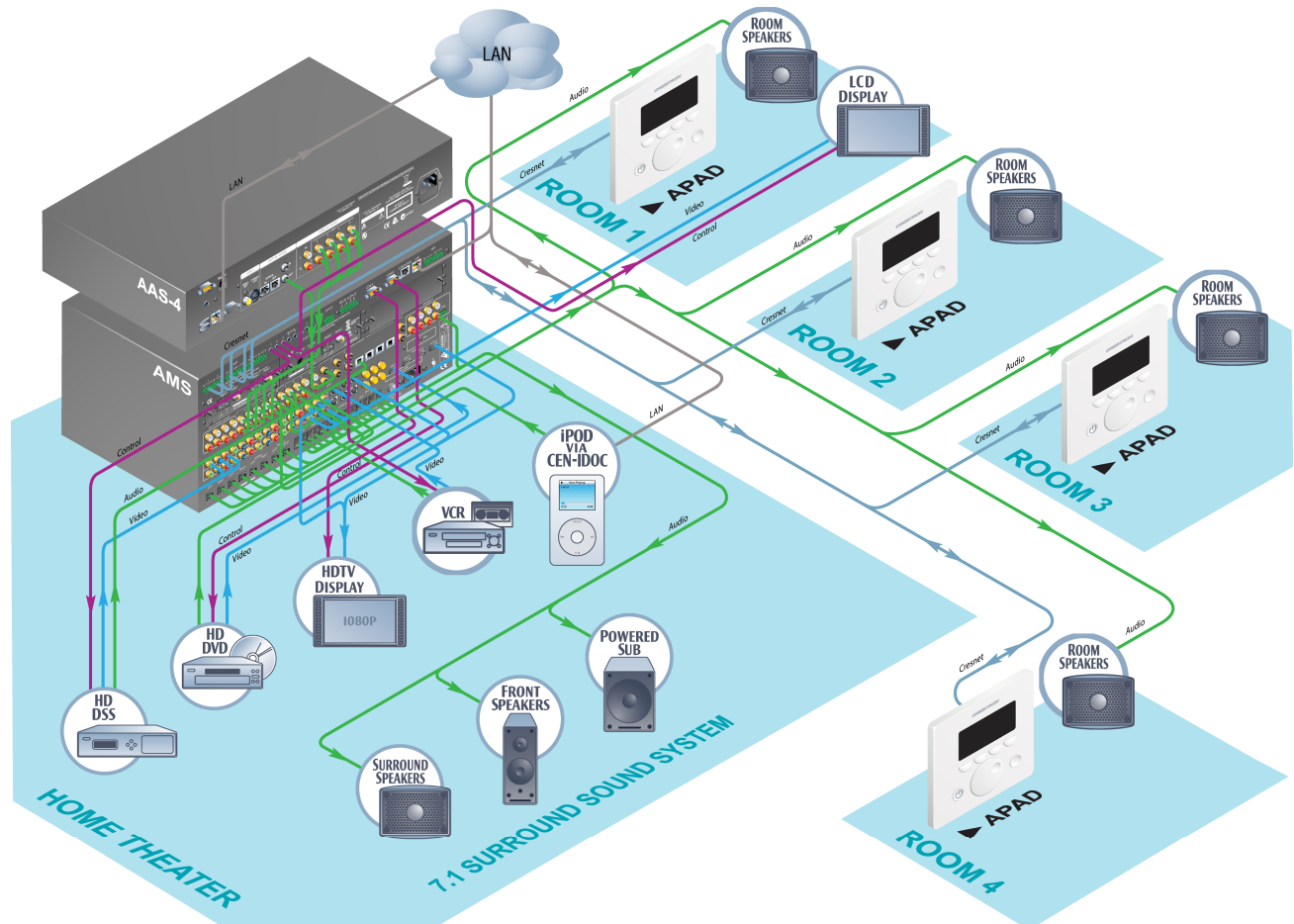

Available models are:

- AMS: AMS with ATC-AMFM2 Tuner Card
- AMS-XM: AMS with ATC-AMFMXM Tuner Card
- AMS-SR: AMS with ATC-AMFMSR Tuner Card
- AMSI: AMS for International (220-240 VAC) use with ATC-AMFM2 Tuner Card

Out of the box, the AMS can support one AAS (Adagio Audio Server), one AAE (Adagio Audio Expander) for control of up to 12 rooms (depending on configuration), one CEN-IDOC (Interface for Apple iPod®), and a combination of up to 12 C2N-DBF12 (12-button keypads) or APAD controllers for local control of each zone.

With custom programming (via Adagio Composer, Crestron SystemBuilder™, or SIMPL™ Windows®) and additional AAEs, the AMS can control up to 25 zones of audio. Additional APADs, C2N-DBF12s, CEN-IDOCs and AAS devices can also be added as well as other Crestron peripherals.

Specifications

Specifications for the AMS are listed in the following table.

AMS Specifications

SPECIFICATION	DETAILS
Processor CPU	32-bit Freescale ColdFire® Microprocessor
Memory	16MB Flash, 32MB SDRAM, 256KB NVRAM
Operating System	Real-time, preemptive, multitasking kernel, multi-threaded, FAT32 file system with long names; supports SIMPL Windows and SIMPL+®
Ethernet	10/100BaseT, static IP or DHCP/DNS, SSL, autonegotiating, full duplex TCP/IP, UDP/IP, SMTP, SNMP, built-in Web server and e-mail client; supports Crestron e-Control®2 XPanel and RoomView® applications
Video Switchers	3x1 HDMI switcher, 8x2 component matrix, 4x2 S-Video matrix, 4x2 composite matrix
Signal Types	HDMI, component (YPbPr), S-video (Y/C), and composite video (does not transcode)
Formats	NTSC or PAL, HDTV up to 1080i/1080p
Gain	0dB (75 ohms terminated)
Bandwidth	400 MHz
Crosstalk	>54dB
Signal-to-Noise Ratio (SNR)	>70dB

(Continued on following page)

AMS Specifications (Continued)

SPECIFICATION	DETAILS
Audio – Surround Sound Processor	
Processor	Texas Instruments DA610 Aureus™ 32-bit floating point DSP w/Audysey MultEQ® XT setup algorithms
Analog-To-Digital Conversion	24-bit 48 kHz
Digital-To-Analog Conversion	24-bit 48 kHz
Supported Formats/Modes	Bypass, Stereo, 2-channel steering (surround or rear), Multi-channel stereo, Ambience Effects (Cathedral, Hall, Stadium, Jazz Club), Dolby® Pro Logic IIx, Dolby Digital 5.1, Dolby Digital EX, DTS Neo:6, DTS Digital 5.1 Discrete, DTS ES 6.1 Discrete, DTS ES 6.1 Matrix, DTS 96/24
Surround Sound Master Volume	-80dB to +20dB, 0.5dB steps
Speaker Compensation	±12dB, 0.5dB steps
Low Frequency Effects (LFE)	-10dB to +0dB, 0.5dB steps
Mode Trim (Level Preset)	±12dB, 0.5dB steps (master); ±12dB, 0.5dB steps (per output); -10dB to +0dB, 0.5dB steps (LFE)
Input Compensation	±10dB, 1dB steps
Mute	-80dB (electronic), >-100dB (relay)
Bass Gain Range	±12dB, 1dB steps
Treble Gain Range	±12dB, 1dB steps
EQ Modes	Audyssey MultEQ XT or 6-band parametric or graphic per surround/subwoofer output channel
PEQ Filter Gain	±12dB, 0.5dB steps
PEQ Filter Bandwidth	0.02 to 2.0 octaves
PEQ Filter Center Frequency	20Hz to 20KHz
GEQ Filter Gain	±10dB, 0.5dB steps
GEQ Filter Center Frequencies	50, 180, 630, 2.3k, 8k Hz
Crossover/High-Pass Frequency	40 to 200 Hz, 10 Hz steps
Maximum Delay	100ms per channel, picture delay (lip-sync) and speaker distance compensation combined
Dynamic Range (compression)	Minimum, Standard, Maximum
Frequency Response	20Hz to 20kHz ±0.01dB (preamp), 20Hz to 20kHz ±0.2dB (power amp)
Total Harmonic Distortion (THD) + Noise	<0.006% (preamp), 0.03% (power amp) 20Hz to 20kHz
Signal-to-Noise Ratio (SNR)	>100dB (preamp), 100dB (power amp) 20Hz to 20kHz A-weighted
Dynamic Range	>113dB
Channel Separation	>85dB (preamp), >80dB (power amp)

(Continued on following page)

AMS Specifications (Continued)

SPECIFICATION	DETAILS
Audio – Multi Room Distribution (Typical of up to 5 Stereo, or 4 Stereo + 2 Mono Room Outputs) Controls Volume Gain Range Mute Input Compensation Bass Gain Range Treble Gain Range Frequency Response Signal-to-Noise Ratio (SNR) Total Harmonic Distortion (THD) + Noise Stereo Separation	Volume, Balance, Bass, Treble, Loudness, Mute, Mono, Input Compensation -80dB to +20dB, 1 dB steps -100dB (electronic), -120dB (relay/room off) ±10dB, 1db steps ±12dB, 2dB steps ±12dB, 2dB steps 20Hz to 20kHz ±0.4dB >100dB 20Hz to 20kHz A-weighted <0.08% 20Hz to 20kHz >75dB
Power Internal Power Supply AMS/ AMS-XM/ AMS-SR AMSI Available Cresnet Power	1000 Watts (8 Amps) @ 120 Volts AC, 50-60Hz 1000 Watts (4 Amps) @ 220-240 Volts AC, 50-60Hz 20 Watts (0.83 Amps @ 24 Volts DC)
LCD Display	Green LCD dot matrix, 128 x 64 resolution, adjustable LED backlight
Environmental Temperature Humidity Heat Dissipation* 8-ohm impedance 4-ohm impedance	41° to 104°F (5° to 40°C) 10% to 90% RH (non-condensing) 1600 BTU/hr 2000 BTU/hr
Enclosure	Black metal with molded ABS/PC front panel; Freestanding, side ventilation should not be restricted
Dimensions Height Width Depth	7.39 in (18.78 cm) 17.16 in (43.59 cm) 18.56 in (47.13 cm)
Weight	57.5 lb (26.1 kg)

(Continued on following page)

AMS Specifications (Continued)

SPECIFICATION	DETAILS
Available Models AMS AMS-XM AMS-SR AMSI	AMS with ATC-AMFM2 Dual AM/FM Tuner Card AMS with ATC-AMFMXM AM/FM and XM Satellite Radio Tuner Card AMS with ATC-AMFM2SR AM/FM and SIRIUS Satellite Radio Tuner Card AMS for International (220-240 VAC) use with ATC-AMFM2 Dual AM/FM Tuner Card
Available Accessories: AAE AAS APAD ATC-AMFM2 ATC-AMFM2SR ATC-AMFMXM C2N-DBF12 C2N-TXM-C50 CEN-IDOC CLS-C6(M) CNSP-XX CNXRMIRD Crestron Professional Surround Sound Tuning Kit STIRP	Adagio Audio Expander Adagio Audio Server Wall Mount LCD Controller Adagio Dual AM/FM Tuner Card Adagio AM/FM and SIRIUS® Satellite Radio Tuner Card Adagio AM/FM and XM Satellite Radio Tuner Card 12-Button Decorator Keypad XM Antenna Extension Cable Interface for Apple iPod® iLux Integrated Lighting System Custom Serial Interface Cable IR Receiver Surround Sound Tuning Kit IR Probe

* BTU/hr ratings made while all channels loaded to 1/8 full power with specified impedance.

Physical Description

This section provides information on the connections, controls, and indicators available on your AMS.

AMS Physical View (Front)



AMS Physical View (Rear), Shown with ATC-AMFM2 Adagio AM/FM Dual Tuner Card and ATC-AMFMXM Adagio AM/FM and XM Satellite Radio Tuner Card

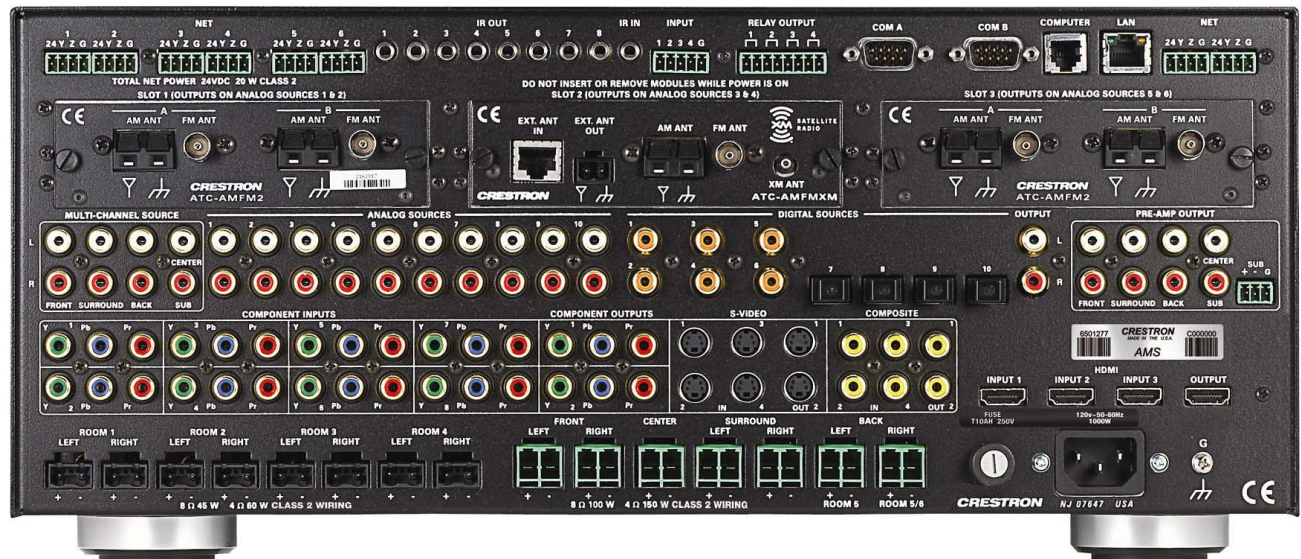

AMS Overall Dimensions

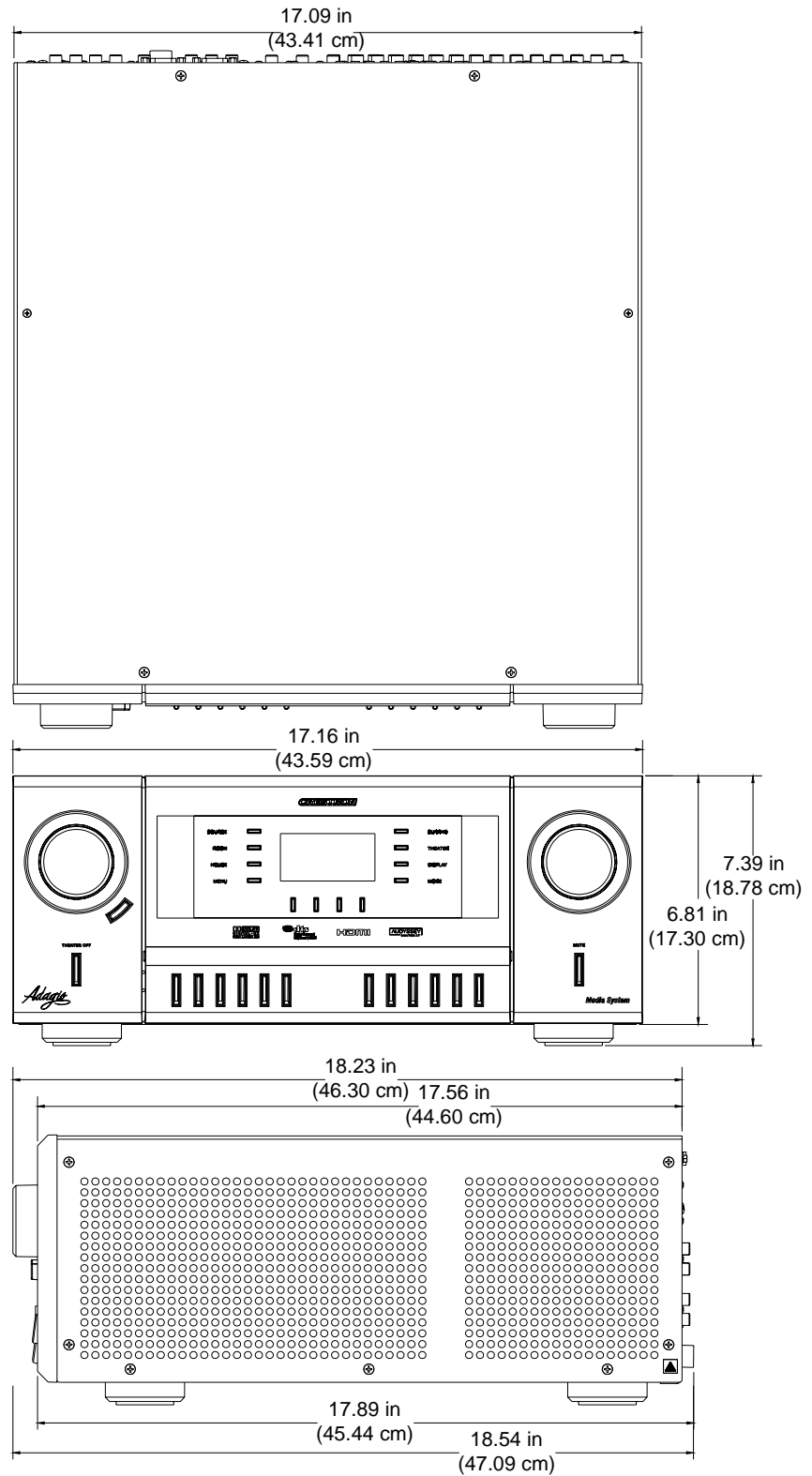

NOTE: Cable connections can extend the overall depth of the AMS by approximately two to three inches.

AMS Buttons and Ports

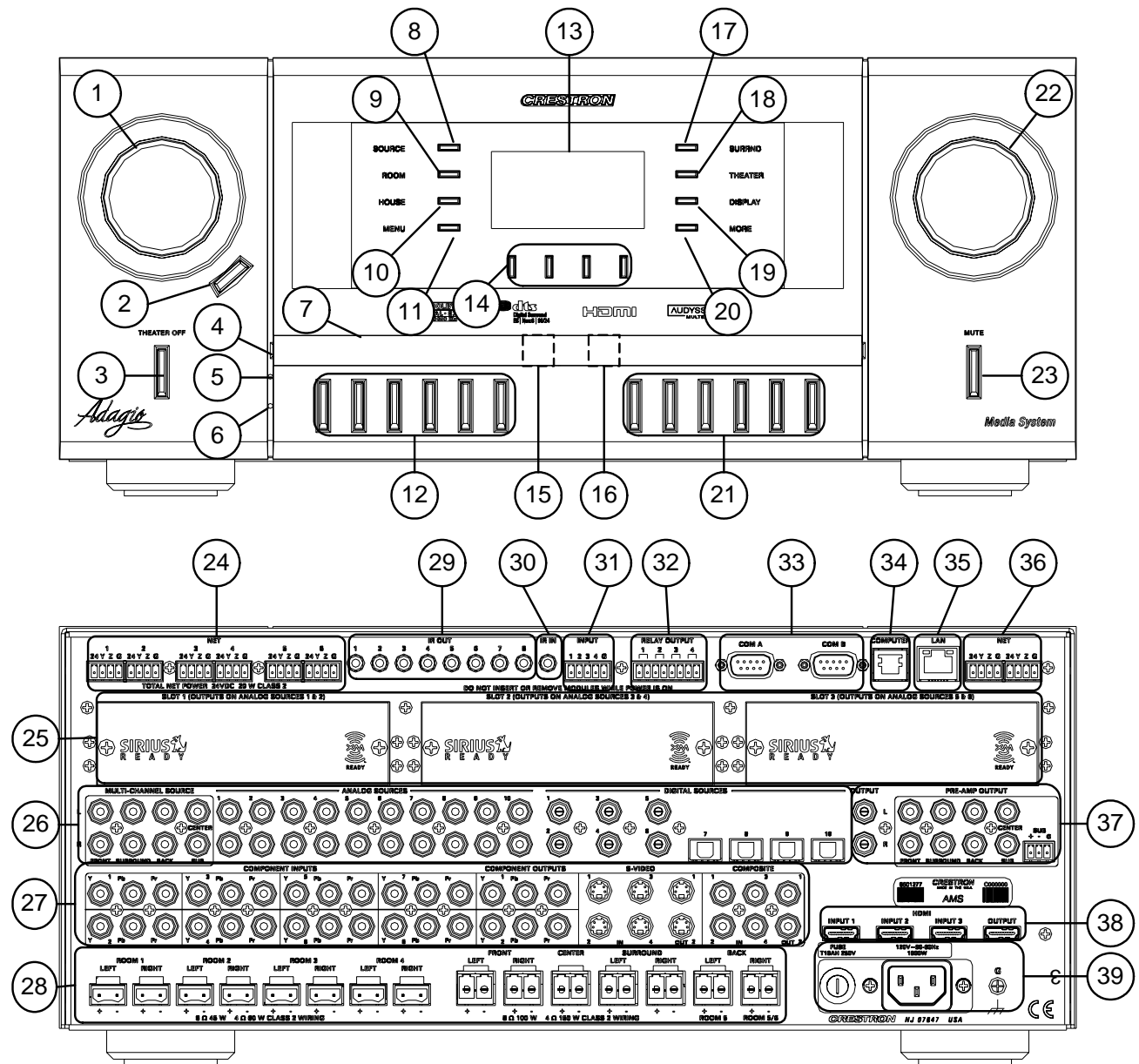



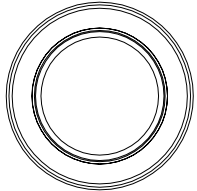







Connectors, Controls, & Indicators

#	CONNECTORS, CONTROLS, & INDICATORS	DESCRIPTION
1	SELECTION KNOB 	Used to select rooms, sources, and radio stations (when using tuner), and other parameters.



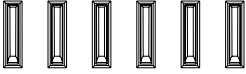





(Continued on following page)

Connectors, Controls, & Indicators (Continued)

#	CONNECTORS, CONTROLS, & INDICATORS	DESCRIPTION
2	ENTER BUTTON 	The ENTER button confirms changes made to AMS settings.
3	THEATER OFF BUTTON THEATER OFF 	Pushbutton with green LED. The THEATER OFF button turns off all of the theater outputs. The button is lit when the theater outputs are on. When the theater outputs are off, the button will not be lit, all theater connections are broken, and all of the amplifier and pre-amplifier outputs are powered off.
4	LABEL ACCESS	A notch in the front panel allows removal of the label cover (and access to the USB port, # 15 and the microphone jack, #16) with a flat-head screwdriver.
5	HARDWARE RESET 	Recessed below the front panel. Press this button to initiate a system hardware reset. This has the same effect as disconnecting and reconnecting power.
6	SOFTWARE RESET 	Recessed below the front panel. Press this button while the system is running to restart the program without rebooting the processor. Hold during reboot to bypass the custom program and run the built-in out-of-the-box functionality.
7	LABEL STRIP COVER	Covers the engraved label strip, the USB port (#15), and the microphone jack (#16).
8	SOURCE BUTTON SOURCE 	The SOURCE button places the AMS in the <i>Source</i> mode.
9	ROOM BUTTON ROOM 	The ROOM button places the AMS in the <i>Room</i> mode.
10	HOUSE BUTTON HOUSE 	Functions controlled by the HOUSE button are determined in a custom program created by SystemBuilder.
11	MENU BUTTON MENU 	The MENU button returns the display (#13) to the previous screen.
12	ROOM BUTTONS 	Room buttons select individual rooms, <i>Party</i> mode (all rooms are on), or turn off all of the rooms (ALL OFF). The actual function is set by the theater configuration. For more information, refer to "Configure the Theater" on page 43.
13	LIQUID CRYSTAL DISPLAY	The Liquid Crystal Display (LCD) shows system information such as audio controls, tuner controls, and room controls.
14	SOFT BUTTONS 	Function of soft buttons are dependent on operation of AMS.

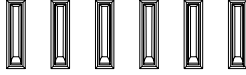
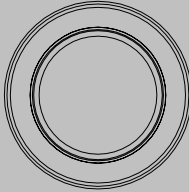

(Continued on following page)

Connectors, Controls, & Indicators (Continued)

#	CONNECTORS, CONTROLS, & INDICATORS	DESCRIPTION										
15	<p>USB PORT</p> 	<p>(1) USB Type B female; USB 1.1 computer console port (cable included)</p> <table border="1"> <thead> <tr> <th>PIN</th> <th>DESCRIPTION</th> </tr> </thead> <tbody> <tr> <td>1</td> <td>+5 VDC</td> </tr> <tr> <td>2</td> <td>Data -</td> </tr> <tr> <td>3</td> <td>Data +</td> </tr> <tr> <td>4</td> <td>Ground</td> </tr> </tbody> </table>	PIN	DESCRIPTION	1	+5 VDC	2	Data -	3	Data +	4	Ground
PIN	DESCRIPTION											
1	+5 VDC											
2	Data -											
3	Data +											
4	Ground											
16	<p>MICROPHONE</p> 	<p>(1) 3.5mm TRS mini-phone jack Input for calibrated microphone (part of CSSTK Surround Sound Tuning Kit, sold separately)</p>										
17	<p>SURRND</p> 	<p>The SURRND button displays the currently selected <i>Surround Sound</i> mode and allows the user to change the <i>Surround Sound</i> mode.</p>										
18	<p>THEATER</p> 	<p>The THEATER button places the AMS in the <i>Theater</i> mode. The <i>Theater</i> mode is used to view and/or listen to video and audio sources in the theater room.</p>										
19	<p>DISPLAY</p> 	<p>The DISPLAY button toggles the information shown on the display (i.e. artist and/or song title).</p>										
20	<p>MORE</p> 	<p>The MORE button displays additional controls for the soft buttons (if available).</p>										
21	<p>THEATER SOURCE BUTTONS</p> 	<p>Used to select input sources for the theater room. The actual function is set by the theater configuration. For more information, refer to “Configure the Theater” on page 43.</p>										
22	<p>VOLUME CONTROL KNOB</p> 	<p>Turn clockwise to raise the volume of a room or the theater; turn counterclockwise to lower the volume of a room or the theater. Turning the volume control slowly will adjust the volume level in fine increments while turning the volume control quickly will adjust the volume level in larger increments. Volume level is displayed on the LCD. Operates in <i>Room</i> and <i>Theater</i> mode only.</p>										
23	<p>MUTE BUTTON</p> 	<p>The MUTE button is used to mute or unmute the currently selected room (theater is default). When lit, the selected room is muted.</p>										

(Continued on following page)

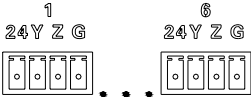
Connectors, Controls, & Indicators (Continued)

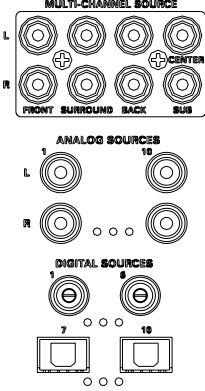
#	CONNECTORS, CONTROLS, & INDICATORS	DESCRIPTION
24	<p style="text-align: center;">NET 1-6</p> 	<p>(6) 4-pin 3.5mm detachable terminal blocks Cresnet Master ports</p> <p>Provide data and power for keypads and other Cresnet devices</p> <p>Four-pin terminal block interface connectors are included for each port.</p>
25	<p style="text-align: center;">CARD SLOTS 1-3 (SLOT 1 SHOWN WITH ATC-AMFM2 INSTALLED)</p> 	<p>(3) Adagio tuner card slots</p> <p>Accept choice of dual tuner cards; outputs from the tuner cards parallel with ANALOG SOURCES 1 – 6</p>
26	<p style="text-align: center;">AUDIO SOURCES</p> 	<p>MULTI-CHANNEL SOURCE: (8) RCA female; Unbalanced line-level 7.1 Surround Sound audio inputs;</p> <p style="padding-left: 20px;">Maximum Input: 3.2 V_{rms} (flat);</p> <p style="padding-left: 20px;">Input Impedance: 47k ohms</p> <p>ANALOG SOURCES 1-10: (20) RCA female providing (10) unbalanced stereo line-level, analog audio inputs;</p> <p>Inputs 1 through 6 parallel with outputs from tuner cards installed in slots 1 through 3 (#25) and cannot be used by external sources when tuner cards are installed. Refer to “Adagio Tuner Cards” on page 36 for information on which input ports are reserved for which card slot;</p> <p style="padding-left: 20px;">Maximum Input: 3.2 V_{rms} (flat);</p> <p style="padding-left: 20px;">Input Impedance: 47k ohms</p> <p>DIGITAL SOURCES 1-6: (6) RCA female; S/PDIF coaxial digital audio inputs;</p> <p style="padding-left: 20px;">Input Impedance: 75 ohms</p> <p>DIGITAL SOURCES 7-10: (4) JIS F05 female (TOSLINK) optical fiber connectors; S/PDIF optical digital audio inputs</p>





(Continued on following page)

Connectors, Controls, & Indicators (Continued)

#	CONNECTORS, CONTROLS, & INDICATORS	DESCRIPTION
27	<p style="text-align: center;">VIDEO INPUT/OUTPUT</p> <p>The diagram illustrates the following connector types and their counts:</p> <ul style="list-style-type: none"> COMPONENT INPUTS: 8 RCA female connectors, labeled Y, Pb, Pr, Y, Pb, Pr, Y, Pb, Pr. COMPONENT OUTPUTS: 6 RCA female connectors, labeled Y, Pb, Pr, Y, Pb, Pr. S-VIDEO: 4 mini-DIN female connectors, labeled IN 4 and OUT 2. COMPOSITE: 4 RCA female connectors, labeled IN 4 and OUT 2. 	<p>COMPONENT VIDEO INPUTS 1-8: (24) RCA female comprising (8) component/HDTV (YPbPr) video inputs; Input signal sensing on “Y”; Input Level: 1 V_{p-p} nominal (Y), 0.7 V_{p-p} nominal (PbPr); Input Impedance: 75 ohms nominal</p> <p>COMPONENT VIDEO OUTPUTS 1 and 2: (6) RCA female comprising (2) component/HDTV (YPbPr) video outputs; Output Level: 1 V_{p-p} nominal (Y), 0.7 V_{p-p} nominal (PbPr); Output Impedance: 75 ohms nominal</p> <p>S-VIDEO INPUTS 1-4: (4) 4-pin mini-DIN female; S-Video (Y/C) video inputs w/input signal sensing on “Y”; Input Level: 1 V_{p-p} nominal (Y), 0.7 V_{p-p} nominal (C); Input Impedance: 75 ohms nominal</p> <p>S-VIDEO OUTPUTS 1 and 2: (2) 4-pin mini-DIN female; S-Video (Y/C) video outputs; Output Level: 1 V_{p-p} nominal (Y), 0.7 V_{p-p} nominal (C); Output Impedance: 75 ohms nominal</p> <p>COMPOSITE VIDEO INPUTS 1-4: (4) RCA female; Composite video inputs w/input signal sensing; Input Level: 1 V_{p-p} nominal; Input Impedance: 75 ohms nominal</p> <p>COMPOSITE VIDEO OUTPUTS 1 and 2: (2) RCA female; Composite video outputs; Output Level: 1 V_{p-p} nominal; Output Impedance: 75 ohms nominal</p>

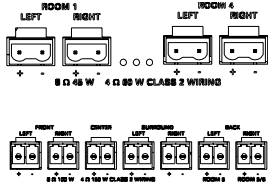

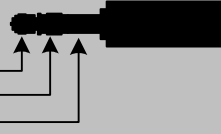
(Continued on following page)

Connectors, Controls, & Indicators (Continued)

#	CONNECTORS, CONTROLS, & INDICATORS	DESCRIPTION
28	<p style="text-align: center;">SPEAKER OUTPUTS</p> 	<p>ROOM 1-4: (8) 2-pin 7.62mm detachable terminal blocks; Multi-room amplifier outputs;</p> <p>Wire Size: Terminals accept up to 12 AWG (4.0 mm²); Interface connectors included.</p> <p>Output Power: 45 Watts/Ch. at 8 ohms, 60 Watts/Ch. at 4 ohms</p> <p>FRONT, CENTER, SURROUND, BACK or ROOM 5/6: (7) 2-pin 7.62mm, 20A detachable terminal blocks; Power amplifier outputs;</p> <p>Wire Size: Terminals accept up to 10 AWG (3.0 mm²); Interface connectors included.</p> <p>Output Power: 100 Watts/Ch. at 8 ohms, 150 Watts/Ch. at 4 ohms</p>
29	<p style="text-align: center;">IR OUT</p> <p style="text-align: center;">IR OUT</p> 	<p>(8) 3.5mm TRS mini-phone jack, IR/Serial port;</p> <p>IR output up to 1.2 MHz; 1-way serial TTL/RS-232 (0-5V) up to 9600 baud</p> <p>Use Crestron Infrared Emitter Probe (part number STIRP, sold separately) for controlling infrared devices. For information on other serial control cables, contact Crestron.</p>  <p>Tip: IR Data Out Ring: No Connection Sleeve: Ground</p>
30	<p style="text-align: center;">IR IN</p> <p style="text-align: center;">IR IN</p> 	<p>(1) 3.5 mm TRS mini-phone jack;</p> <p>For connection of the CNXRMIRD IR receiver (sold separately);</p> <p>Allows IR wireless control from Crestron and third-party remotes using RC-5 IR commands.</p>  <p>Tip: IR Data In Ring: +5 VDC Sleeve: Ground</p>



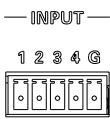
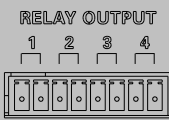

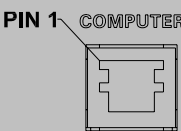
(Continued on following page)

Connectors, Controls, & Indicators (Continued)

#	CONNECTORS, CONTROLS, & INDICATORS	DESCRIPTION																														
31	<p>INPUT</p> 	<p>(1) 5-pin 3.5mm detachable terminal block; Comprises (4) digital inputs; Rated for 0-24 Volts DC, referenced to GND; A five-pin terminal block interface connector is included.</p> <p>Input Impedance: 2.2k ohms pulled up to 5 Volts DC;</p> <p>Logic Threshold: 2.5 Volts DC nominal</p>																														
32	<p>RELAY OUTPUT</p> 	<p>(1) 8-pin 3.5mm detachable terminal block; Comprises (4) normally open, isolated relays; Rated 1 Amp, 30 Volts AC/DC; MOV arc suppression across contacts; An eight-pin terminal block interface connector is included.</p>																														
33	<p>COM A & COM B</p> 	<p>(2) DB9 male, bidirectional RS-232 ports; Up to 115.2k baud, hardware and software handshaking support for communication with serial devices. Can also be used for modem communications. The following table lists the pin assignments of the serial ports.</p> <table border="1"> <thead> <tr> <th>PIN</th> <th>DIRECTION</th> <th>DESCRIPTION</th> </tr> </thead> <tbody> <tr> <td>1</td> <td>To AMS</td> <td>(DCD) Data Carrier Detect</td> </tr> <tr> <td>2</td> <td>To AMS</td> <td>(RXD) Receive Data</td> </tr> <tr> <td>3</td> <td>From AMS</td> <td>(TXD) Transmit Data</td> </tr> <tr> <td>4</td> <td>From AMS</td> <td>(DTR) Data Terminal Ready</td> </tr> <tr> <td>5</td> <td>Common</td> <td>(GND) Ground</td> </tr> <tr> <td>6</td> <td>To AMS</td> <td>(DSR) Data Set Ready</td> </tr> <tr> <td>7</td> <td>From AMS</td> <td>(RTS) Request To Send</td> </tr> <tr> <td>8</td> <td>To AMS</td> <td>(CTS) Clear To Send</td> </tr> <tr> <td>9</td> <td>To AMS</td> <td>(RI) Ring Indicator</td> </tr> </tbody> </table>	PIN	DIRECTION	DESCRIPTION	1	To AMS	(DCD) Data Carrier Detect	2	To AMS	(RXD) Receive Data	3	From AMS	(TXD) Transmit Data	4	From AMS	(DTR) Data Terminal Ready	5	Common	(GND) Ground	6	To AMS	(DSR) Data Set Ready	7	From AMS	(RTS) Request To Send	8	To AMS	(CTS) Clear To Send	9	To AMS	(RI) Ring Indicator
PIN	DIRECTION	DESCRIPTION																														
1	To AMS	(DCD) Data Carrier Detect																														
2	To AMS	(RXD) Receive Data																														
3	From AMS	(TXD) Transmit Data																														
4	From AMS	(DTR) Data Terminal Ready																														
5	Common	(GND) Ground																														
6	To AMS	(DSR) Data Set Ready																														
7	From AMS	(RTS) Request To Send																														
8	To AMS	(CTS) Clear To Send																														
9	To AMS	(RI) Ring Indicator																														
34	<p>COMPUTER</p> 	<p>(1) 6-pin RJ-11 female, bidirectional RS-232 computer console port. Use with included serial cable.</p> <p>Pin 1: CTS Pin 2: GND Pin 3: RXD Pin 4: TXD Pin 5: RTS Pin 6: N/C (Not connected)</p>																														

(Continued on following page)

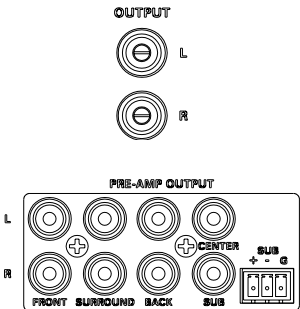
Connectors, Controls, & Indicators (Continued)

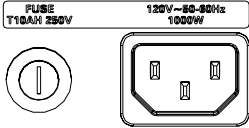
#	CONNECTORS, CONTROLS, & INDICATORS	DESCRIPTION
35	<p>LAN</p> 	<p>(1) 8-wire RJ-45 with 2 LED indicators, 10/100BaseT Ethernet port;</p> <p>Green LED indicates link status, Yellow LED indicates Ethernet activity</p>
36	<p>NET</p> 	<p>(2) 4-pin 3.5mm detachable terminal blocks; Cresnet Master ports, paralleled with NET ports 1 through 6; Connect to AAE(s). A four-pin terminal block interface connector is included for each port.</p>
37	<p>AUDIO OUT</p> 	<p>OUTPUT:</p> <p>(2) RCA female; Unbalanced stereo line-level audio output containing a stereo downmix of all internal surround sound processor outputs;</p> <p>Maximum Output Level: 2.5 V_{rms};</p> <p>Output Impedance: 50 ohms</p> <p>PRE-AMP OUTPUT:</p> <p>(8) RCA female; Unbalanced line-level 7.1 surround sound audio outputs;</p> <p>Maximum Output Level: 2.5 V_{rms} (front, surround, back, center); 6.3 V_{rms} (sub);</p> <p>Output Impedance: 50 ohms</p> <p>SUB (balanced):</p> <p>(1) 3-pin 3.5mm detachable terminal block; Balanced line-level subwoofer audio output;</p> <p>Maximum Output Level: 12.6 V_{rms};</p> <p>Output Impedance: 100 ohms</p> <hr/> <p>NOTE: Stereo downmix output is not affected by changes to volume. Pre-amp surround sound outputs are affected by the volume control.</p>
38	<p>HDMI</p> 	<p>HDMI INPUT 1-3:</p> <p>(3) 19-pin Type A HDMI 1.1 digital video/audio input; includes HDCP 1.1 protocol</p> <p>HDMI OUTPUT:</p> <p>(1) 19-pin Type A HDMI 1.1 digital video/audio output; includes HDCP 1.1 protocol</p>
39	<p>MAIN POWER INPUT</p> 	<p>Fuse terminal and power connector.</p> <p>The AMS requires a T10AH-type fuse rated at 250 Volts¹. The AMS requires 120 VAC, 50-60 Hz, 8 Amps.</p> <p>The AMSI requires a T5AH-type fuse rated at 250 Volts¹. The AMSI requires 220-240 VAC, 50-60 Hz, 4 Amps².</p>

1. Refer to "Fuse Replacement" on page 38 for additional details.

2. Refer to "Hardware Hookup", which begins on page 20 for additional cord details.

Industry Compliance

This product is Listed to applicable UL Standards and requirements by Underwriters Laboratories Inc.

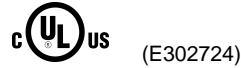

As of the date of manufacture, the AMSI has been tested and found to comply with specifications for CE marking and standards per EMC and Radiocommunications Compliance Labelling.



NOTE: This device complies with part 15 of the FCC rules. Operation is subject to the following two conditions: (1) this device may not cause harmful interference, and (2) this device must accept any interference received, including interference that may cause undesired operation.

This equipment has been tested and found to comply with the limits for a Class B digital device, pursuant to part 15 of the FCC Rules. These limits are designed to provide reasonable protection against harmful interference in a residential installation. This equipment generates, uses and can radiate radio frequency energy and, if not installed and used in accordance with the instructions, may cause harmful interference to radio communications. However, there is no guarantee that interference will not occur in a particular installation. If this equipment does cause harmful interference to radio or television reception, which can be determined by turning the equipment off and on, the user is encouraged to try to correct the interference by one or more of the following measures:

- Reorient or relocate the receiving antenna.
 - Increase the separation between the equipment and receiver.
 - Connect the equipment into an outlet on a circuit different from that to which the receiver is connected.
 - Consult the dealer or an experienced radio/TV technician for help.
-

Setup

Network Wiring

When wiring the AAE Adagio Audio Expander, APAD controller, or C2N-DBF12 keypad to the AMS, consider the following:

- Use Crestron Certified Wire.
- Use Crestron power supplies for Crestron equipment.
- Provide sufficient power to the system.

CAUTION: Insufficient power can lead to unpredictable results or damage to the equipment. Please use the Crestron Power Calculator to help calculate how much power is needed for the system (<http://www.crestron.com/calculators>).

- For larger networks, Use a Cresnet Hub/Repeater (CNXHUB) to maintain signal quality

For more details, refer to “Check Network Wiring” on page 104.

Hardware Hookup

NOTE: Prior to making any connections, refer to the latest version of the Crestron Safety Instructions (Doc. 6607) which can be downloaded from the Crestron website (www.crestron.com/manuals).

Ventilation

The AMS should be used in a well-ventilated area. The venting holes should not be obstructed under any circumstances.

To prevent overheating, do not operate this product in an area that exceeds the environmental temperature range listed in the table of specifications. Consider using forced air ventilation and/or incrementing the spacing between units to reduce overheating. Consideration must be given if installed in a closed or multi-unit rack assembly since the operating ambient temperature of the rack environment may be greater than the room ambient temperature. Contact with thermal insulating materials should be avoided on all sides of the unit.

Speaker Connections

The AMS can be configured for a variety of audio applications. A list of available room configurations, and speaker connection diagrams are available on the following pages.

CAUTION: Speakers must be rated to full available output.

CAUTION: Do not bridge speaker outputs.

NOTE: Unless otherwise stated, connections can be made to the pre-amp output connectors or the speaker connectors.

The following terms are used to denote specific speakers:

- **FL:** Front-Left speaker in theater room
- **FR:** Front-Right speaker in theater room
- **C:** Center Channel speaker in theater room
- **S:** Powered subwoofer in the theater room
- **SL:** Surround-Left speaker in the theater room
- **SR:** Surround-Right speaker in the theater room
- **BL:** Back-Left speaker in the theater room
- **BR:** Back-Right speaker in the theater room
- **BC:** Back-Channel speaker in the theater room (6.1 configuration only)
- **R1L:** Room one, left channel (speaker connectors only)
- **R1R:** Room one, right channel (speaker connectors only)
- **R2L:** Room two, left channel (speaker connectors only)
- **R2R:** Room two, right channel (speaker connectors only)
- **R3L:** Room three, left channel (speaker connectors only)
- **R3R:** Room three, right channel (speaker connectors only)
- **R4L:** Room four, left channel (speaker connectors only)
- **R4R:** Room four, right channel (speaker connectors only)
- **R5L:** Room five, left channel
- **R5R:** Room five, right channel
- **R5M:** Room five, mono channel
- **R6M:** Room six, mono channel

Available Audio Configurations

Audio Configuration	Page
7.1 Theater + Four Stereo Rooms	22
6.1 Theater + Four Stereo Rooms	23
6.1 Theater + Four Stereo Rooms + One Mono Room	24
5.1 Theater + Five Stereo Rooms	25
5.1 Theater + Four Stereo Rooms + One Mono Room	26
5.1 Theater + Four Stereo Rooms + Two Mono Rooms	27
Stereo Theater + Four Stereo Rooms	28
Stereo Theater + Five Stereo Rooms	29
Stereo Theater + Four Stereo Rooms + One Mono Room	30
Stereo Theater + Four Stereo Rooms + Two Mono Rooms	31

7.1 Theater plus Four Stereo Rooms:

The following diagrams show a “7.1 Theater plus four stereo room” configuration and the required wiring.

“7.1 Theater plus Four Stereo Rooms” Configuration

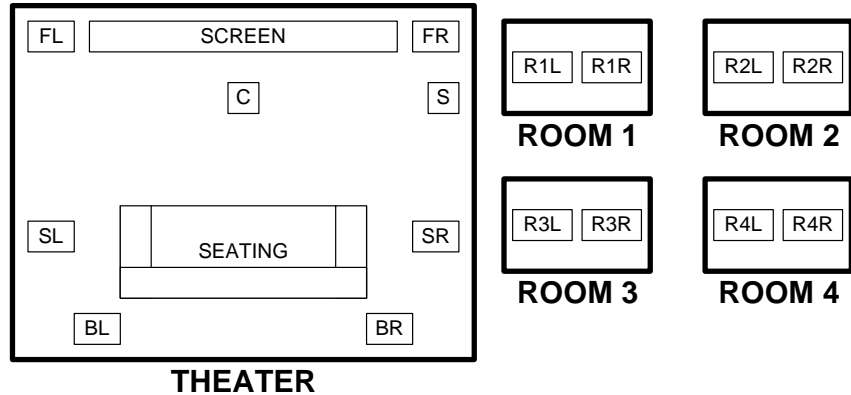

Speaker Hookup for “7.1 Theater plus Four Stereo Rooms”

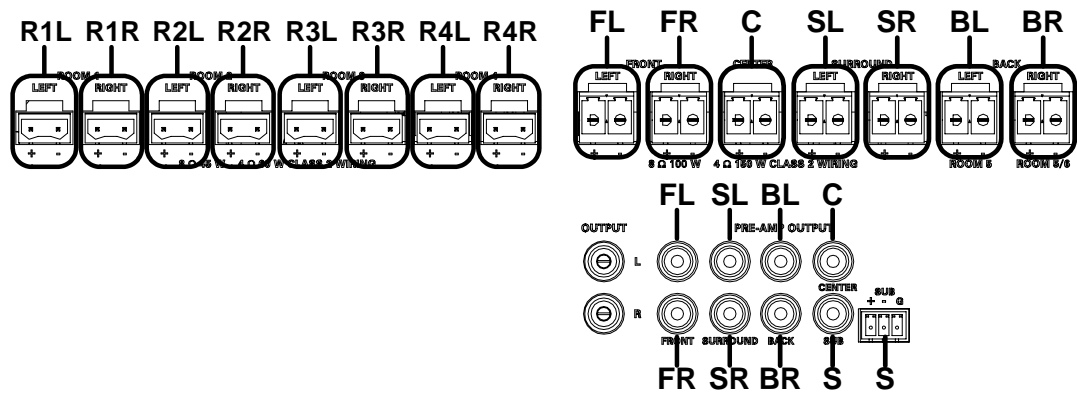

NOTE: The center channel and subwoofer channel can be disabled via Adagio Composer or through the Installer Tools configuration tool. Refer to the Adagio Composer help file or “Configure the Theater” on page 43.

NOTE: Connect the subwoofer to the RCA connector or the 3-position terminal block connector.

6.1 Theater plus Four Stereo Rooms:

The following diagrams show a “6.1 Theater plus four stereo room” configuration and the required wiring.

“6.1 Theater plus Four Stereo Rooms” Configuration

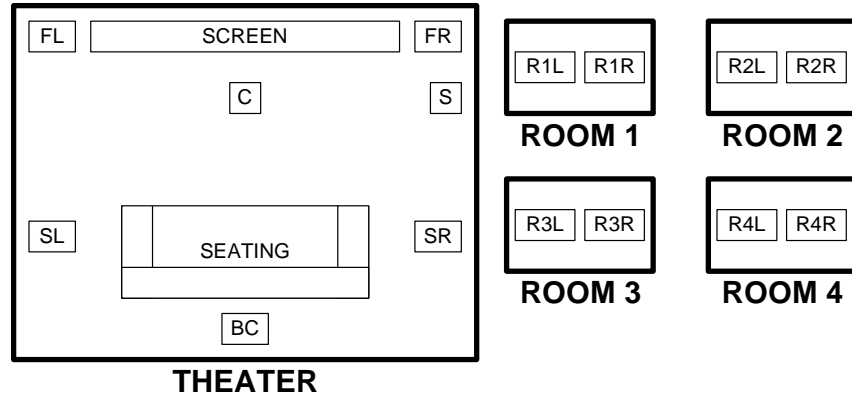

Speaker Hookup for “6.1 Theater plus Four Stereo Rooms”

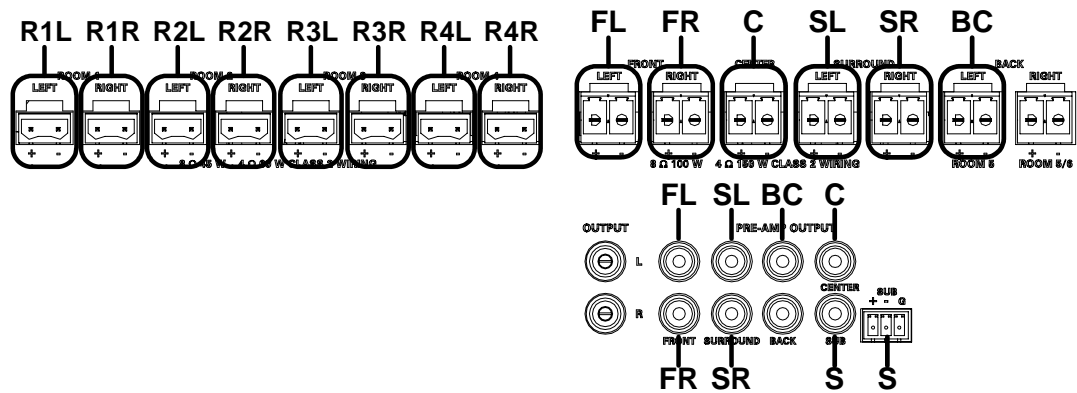

NOTE: The center channel and subwoofer channel can be disabled via Adagio Composer or through the Installer Tools configuration tool. Refer to the Adagio Composer help file or “Configure the Theater” on page 43.

NOTE: Connect the subwoofer to the RCA connector or the 3-position terminal block connector.

6.1 Theater plus Four Stereo Rooms plus One Mono Room:

The following diagrams show a “6.1 Theater plus four stereo rooms plus one mono room” configuration and the required wiring.

“6.1 Theater plus Four Stereo Rooms plus One Mono Room” Configuration

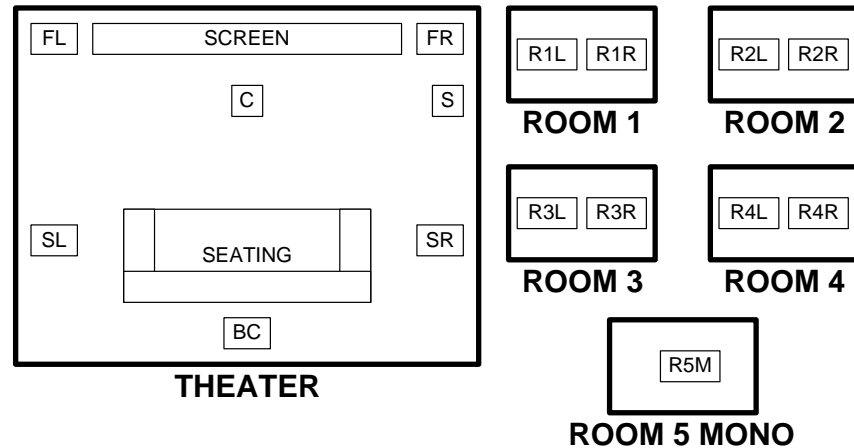

Speaker Hookup for “6.1 Theater plus Four Stereo Rooms plus One Mono Room”

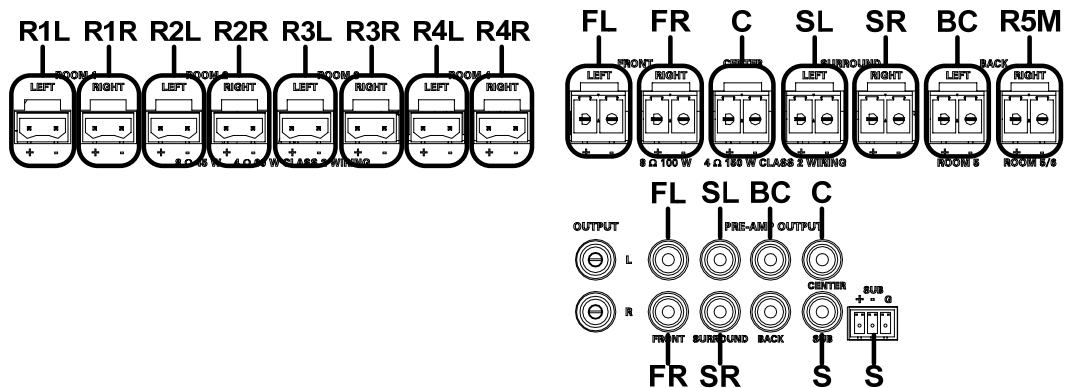

NOTE: The right **PRE-AMP OUTPUT, BACK** connector does not carry any audio signal.

NOTE: The center channel and subwoofer channel can be disabled via Adagio Composer or through the Installer Tools configuration tool. Refer to the Adagio Composer help file or “Configure the Theater” on page 43.

NOTE: Connect the subwoofer to the RCA connector or the 3-position terminal block connector.

5.1 Theater plus Five Stereo Rooms:

The following diagrams show a “5.1 Theater plus five stereo room” configuration and the required wiring.

“5.1 Theater plus Five Stereo Rooms” Configuration

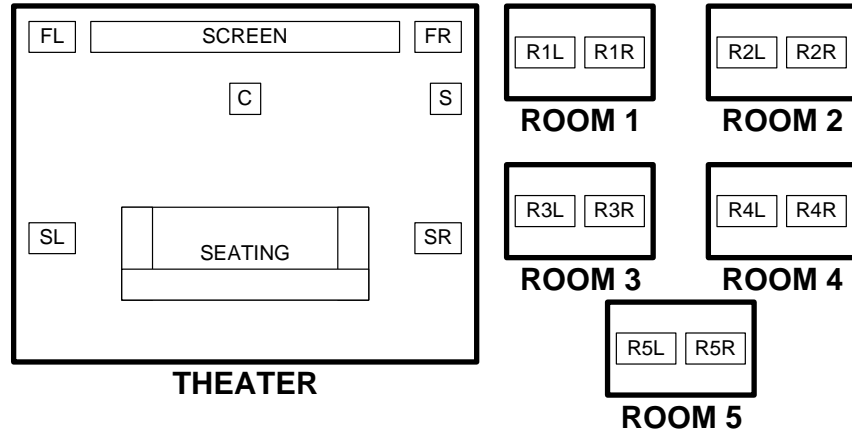

Speaker Hookup for “5.1 Theater plus Five Stereo Rooms”

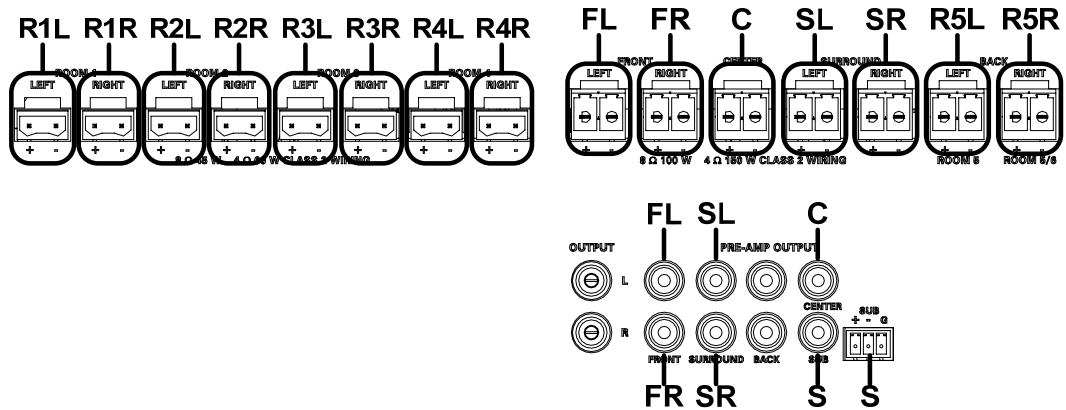

NOTE: The **PRE-AMP OUTPUT**, **BACK** connectors do not carry any audio signal.

NOTE: The center channel and subwoofer channel can be disabled via Adagio Composer or through the Installer Tools configuration tool. Refer to the Adagio Composer help file or “Configure the Theater” on page 43.

NOTE: Connect the subwoofer to the RCA connector or the 3-position terminal block connector.

5.1 Theater plus Four Stereo Rooms plus One Mono Room:

The following diagrams show a “5.1 Theater plus four stereo rooms plus one mono room” configuration and the required wiring.

“5.1 Theater plus Four Stereo Rooms plus One Mono Room” Configuration

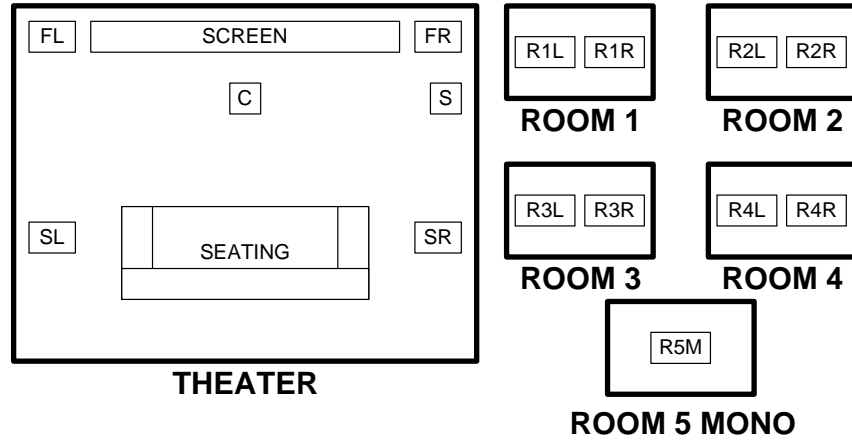

Speaker Hookup for “5.1 Theater plus Four Stereo Rooms plus One Mono Room”

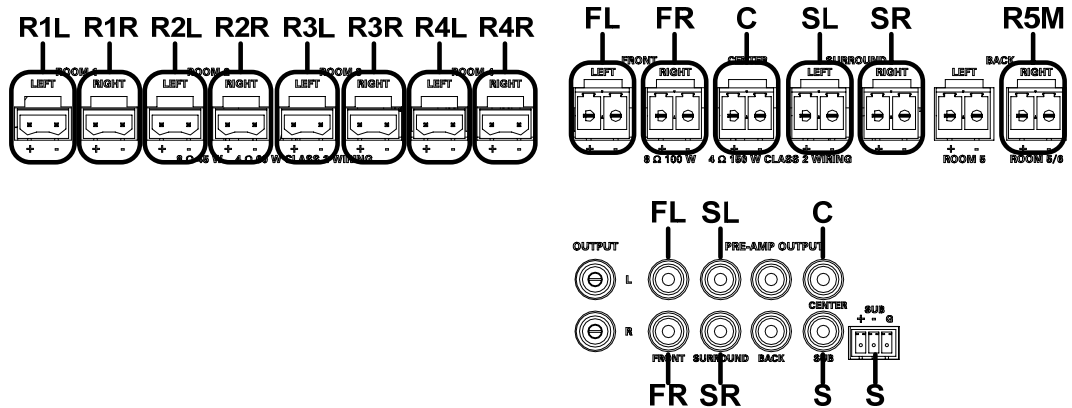

NOTE: The **PRE-AMP OUTPUT**, **BACK** connectors do not carry any audio signal.

NOTE: The center channel and subwoofer channel can be disabled via Adagio Composer or through the Installer Tools configuration tool. Refer to the Adagio Composer help file or “Configure the Theater” on page 43.

NOTE: Connect the subwoofer to the RCA connector or the 3-position terminal block connector.

5.1 Theater plus Four Stereo Rooms plus Two Mono Rooms:

The following diagrams show a “5.1 Theater plus four stereo rooms plus two mono rooms” configuration and the required wiring.

“5.1 Theater plus Four Stereo Rooms plus Two Mono Rooms” Configuration

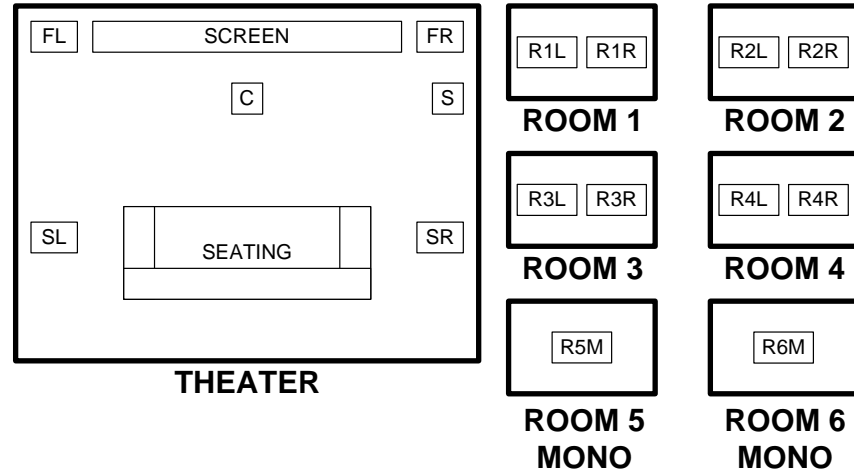

Speaker Hookup for “5.1 Theater plus Four Stereo Rooms plus Two Mono Rooms”

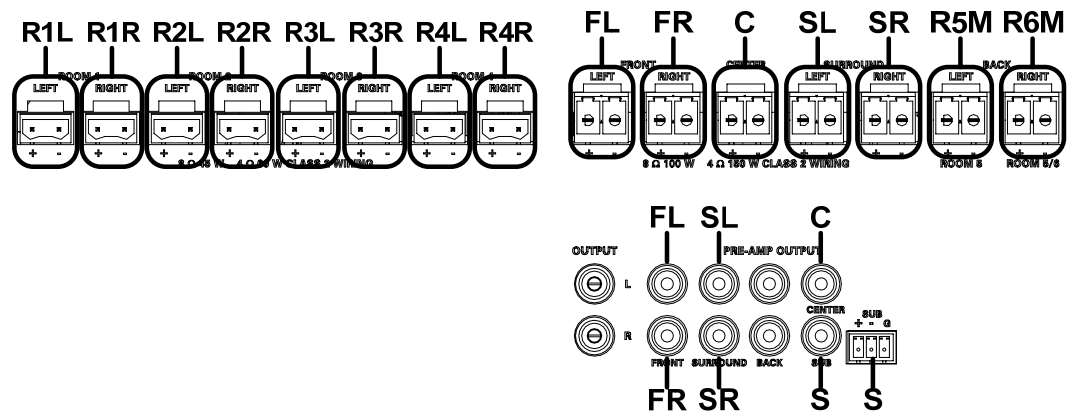

NOTE: The **PRE-AMP OUTPUT**, **BACK** connectors do not carry any audio signal.

NOTE: The center channel and subwoofer channel can be disabled via Adagio Composer or through the Installer Tools configuration tool. Refer to the Adagio Composer help file or “Configure the Theater” on page 43.

NOTE: Connect the subwoofer to the RCA connector or the 3-position terminal block connector.

Stereo Theater plus Four Stereo Rooms:

The following diagrams show a “Stereo Theater plus four stereo rooms” configuration and the required wiring.

“Stereo Theater plus Four Stereo Rooms” Configuration

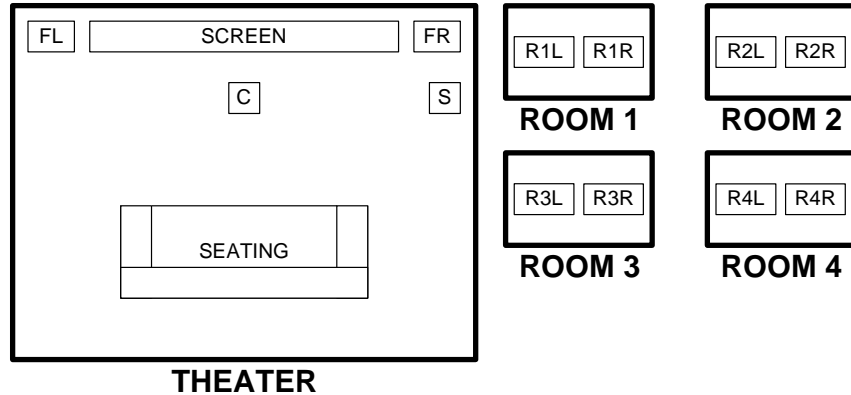

Speaker Hookup for “Stereo Theater plus Four Stereo Rooms”

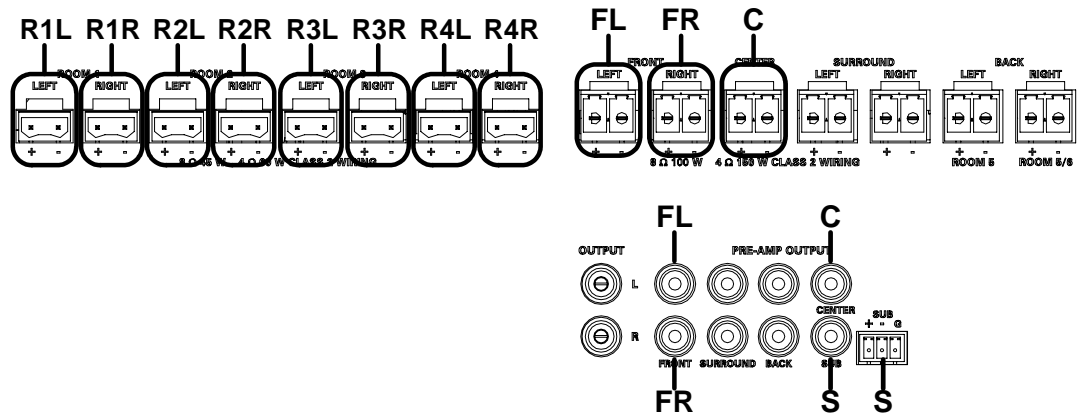

NOTE: The center channel and subwoofer channel can be disabled via Adagio Composer or through the Installer Tools configuration tool. Refer to the Adagio Composer help file or “Configure the Theater” on page 43.

NOTE: Connect the subwoofer to the RCA connector or the 3-position terminal block connector.

Stereo Theater plus Five Stereo Rooms:

The following diagrams show a “Stereo Theater plus five stereo rooms” configuration and the required wiring.

“Stereo Theater plus Five Stereo Rooms” Configuration

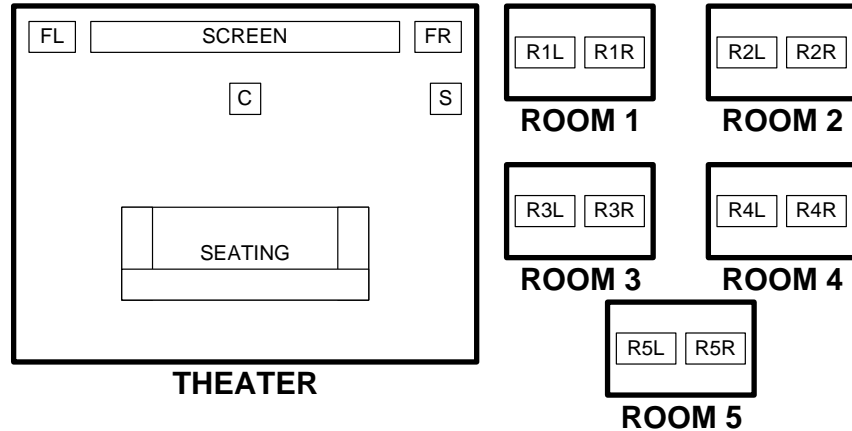

Speaker Hookup for “Stereo Theater plus Five Stereo Rooms”

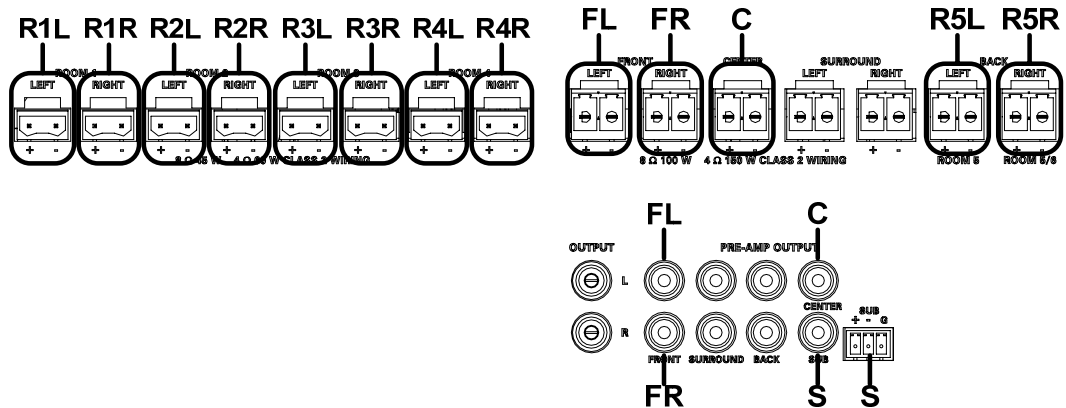

NOTE: The **PRE-AMP OUTPUT**, **BACK** connectors do not carry any audio signal.

NOTE: The center channel and subwoofer channel can be disabled via Adagio Composer or through the Installer Tools configuration tool. Refer to the Adagio Composer help file or “Configure the Theater” on page 43.

NOTE: Connect the subwoofer to the RCA connector or the 3-position terminal block connector.

Stereo Theater plus Four Stereo Rooms plus One Mono Room:

The following diagrams show a “Stereo Theater plus four stereo rooms plus one mono room” configuration and the required wiring.

“Stereo Theater plus Four Stereo Rooms plus One Mono Room” Configuration

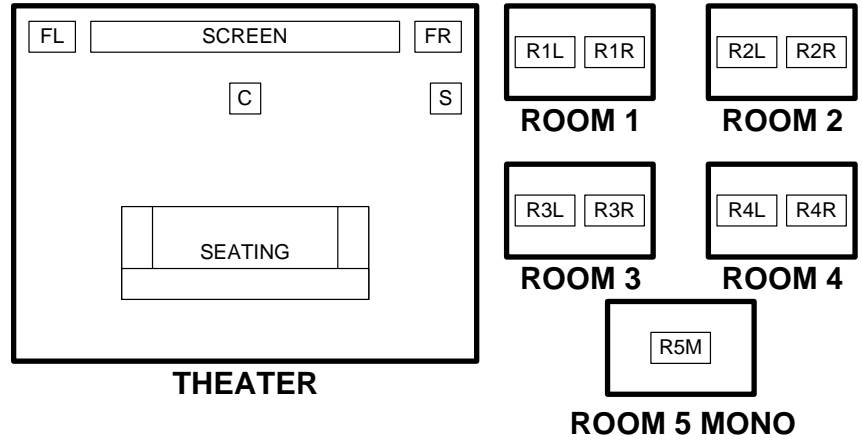

Speaker Hookup for “Stereo Theater plus Four Stereo Rooms plus One Mono Room”

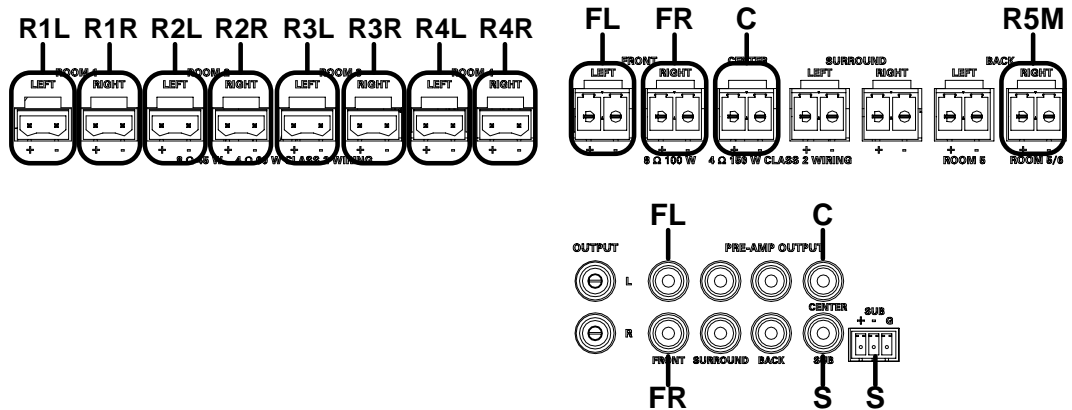

NOTE: The **PRE-AMP OUTPUT**, **BACK** connectors do not carry any audio signal.

NOTE: The center channel and subwoofer channel can be disabled via Adagio Composer or through the Installer Tools configuration tool. Refer to the Adagio Composer help file or “Configure the Theater” on page 43.

NOTE: Connect the subwoofer to the RCA connector or the 3-position terminal block connector.

Stereo Theater plus Four Stereo Rooms plus Two Mono Rooms:

The following diagrams show a “Stereo Theater plus four stereo rooms plus two mono rooms” configuration and the required wiring.

“Stereo Theater plus Four Stereo Rooms plus Two Mono Rooms” Configuration

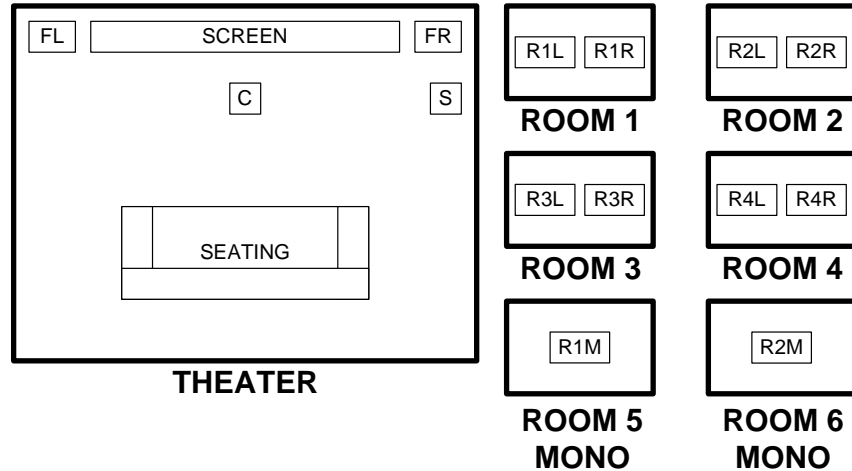

Speaker Hookup for “Stereo Theater plus Four Stereo Rooms plus Two Mono Rooms”

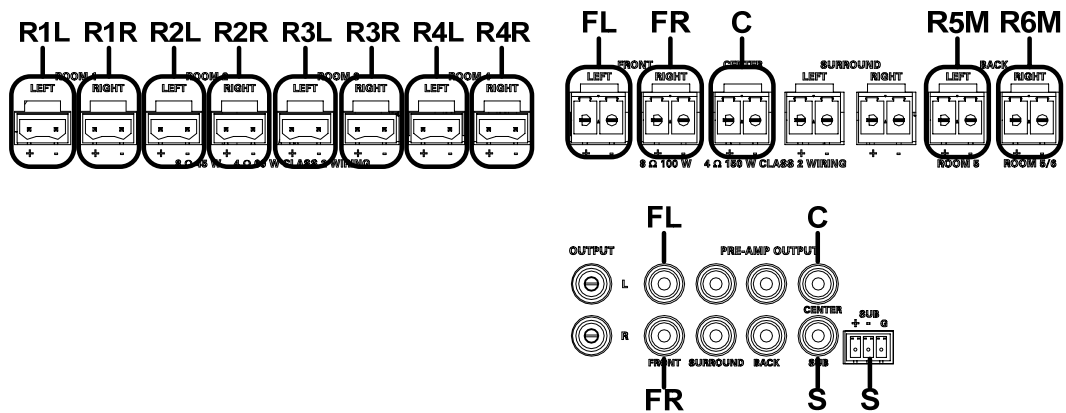

NOTE: The **PRE-AMP OUTPUT**, **BACK** connectors do not carry any audio signal.

NOTE: The center channel and subwoofer channel can be disabled via Adagio Composer or through the Installer Tools configuration tool. Refer to the Adagio Composer help file or “Configure the Theater” on page 43.

NOTE: Connect the subwoofer to the RCA connector or the 3-position terminal block connector.

Out-of-the-box Connections

WARNING: To prevent injury and / or equipment damage due to electric shock, disconnect power from the AMS prior to making any wiring connections.

When using the out-of-the-box functionality, the AMS can support up to two tuner cards, one AAE, one CEN-IDOC, one AAS-1/-2/-4, and any combination of seven

APAD control devices (one in theater room + six rooms) or six C2N-DBF12 control devices (plus an additional six on the AAE if connected). Observe the following when connecting hardware to the AMS.

NOTE: Other sources (analog and digital) can be connected, but cannot be controlled from the AMS or connected control devices.

- **Tuner Cards (Optional):** Tuner cards must be installed in slots 1 and 2. In the out-of-the-box configuration, a card cannot be installed in slot 3. Analog source input ports 1 and 2 are unavailable for other sources when a tuner card is installed in slot 1. Analog source input ports 3 and 4 are unavailable for other sources when a tuner card is installed in slot 2. For information on connecting antennas to a tuner card, refer to the respective tuner card's guide.

NOTE: If the AMS is powered down and the tuner card(s) are changed, the previously saved source names will be assigned to the new card when the AMS is powered. For example, if an ATC-AMFMXM card has been replaced with an ATC-AMFMSR card, the AMS will retain the source names (i.e. AM, FM, XM, or custom) that were assigned to the ATC-AMFMXM card. To have the AMS recognize the new cards and use the default source names (S1 AM/FM, S1 XM, etc.), restore the default settings as described on page 55.

- **CEN-IDOC (Optional):** The audio output of the CEN-IDOC must be connected to source input port 5 on the AMS when using the out-of-the-box configuration. The CEN-IDOC and AMS must be connected to the same DHCP router.
- **AAS Devices (Optional):** Analog source input ports 7 through 10 are reserved for the different variations of the AAS. The AAS and AMS must be connected to the same DHCP router.
 - ⇒ AAS-1: The audio output of the AAS-1 must be connected to analog source input port 7.
 - ⇒ AAS-2: Audio output A of the AAS-2 must be connected to analog source input port 7 and audio output B must be connected to analog source input port 8.
 - ⇒ AAS-4: Audio output A of the AAS-4 must be connected to analog source input port 7. Audio output B must be connected to analog source input port 8. Audio output C must be connected to analog source input port 9, and audio output D must be connected to analog source input port 10.
- **Control Devices (Optional):** Any combination of six APADs or C2N-DBF12 devices can be connected to any of the six NET ports on the rear of the AMS. If an AAE is connected, six more APADs or C2N-DBF12 devices can be connected.

NOTE: The APAD and AMS front panel are the only control devices that can control the theater room when using the out-of-the-box functionality.

- **AAE (Optional):** One AAE can be connected to the AMS' analog audio input ports.

NOTE: If using an AAE, external sources should be connected to the AAE and looped through to the AMS. For more information, refer to the latest version of the AAE guide (Doc. 6460), which is available from the Crestron website.

NOTE: If using an AAE, the left and right downmix outputs of the AMS must be connected to an input on the AAE so rooms connected to the AAE can receive the theater downmix. For more information, refer to “Set AAE Theater Source” on page 52.

NOTE: The AAE must be set to its default Net ID value (31). For information on setting the AAE’s Net ID, refer to the latest version of the AAE guide (Doc. 6460) which is available from the Crestron website.

Make the connections shown in the following diagram for the AMS to properly control and switch connected devices while using the out-of-the-box functionality.

CAUTION: All tuner cards should be securely installed in the AMS.

CAUTION: Devices such as the AAS and the AAE must be fully grounded to the AMS. Additionally, any other source devices should be grounded to the AMS as well.

NOTE: The AMS can only be powered by the included power cord. Power cannot be supplied from network devices that are connected to the mini-terminal block connectors.

NOTE: The AMSI (International version) requires a power cord that is harmonized to the country’s national and local electrical code. Each inner wire in the cord should be at least 16 AWG or (1.5 mm²) and rated for at least 500V. The temperature rating of the cord should be at least 60°C. The cord length should be 1.5 meters to 2 meters.

Hardware Connections for Out-of-the-Box Functionality (Shown with Tuner Cards in Slots 1 & 2)

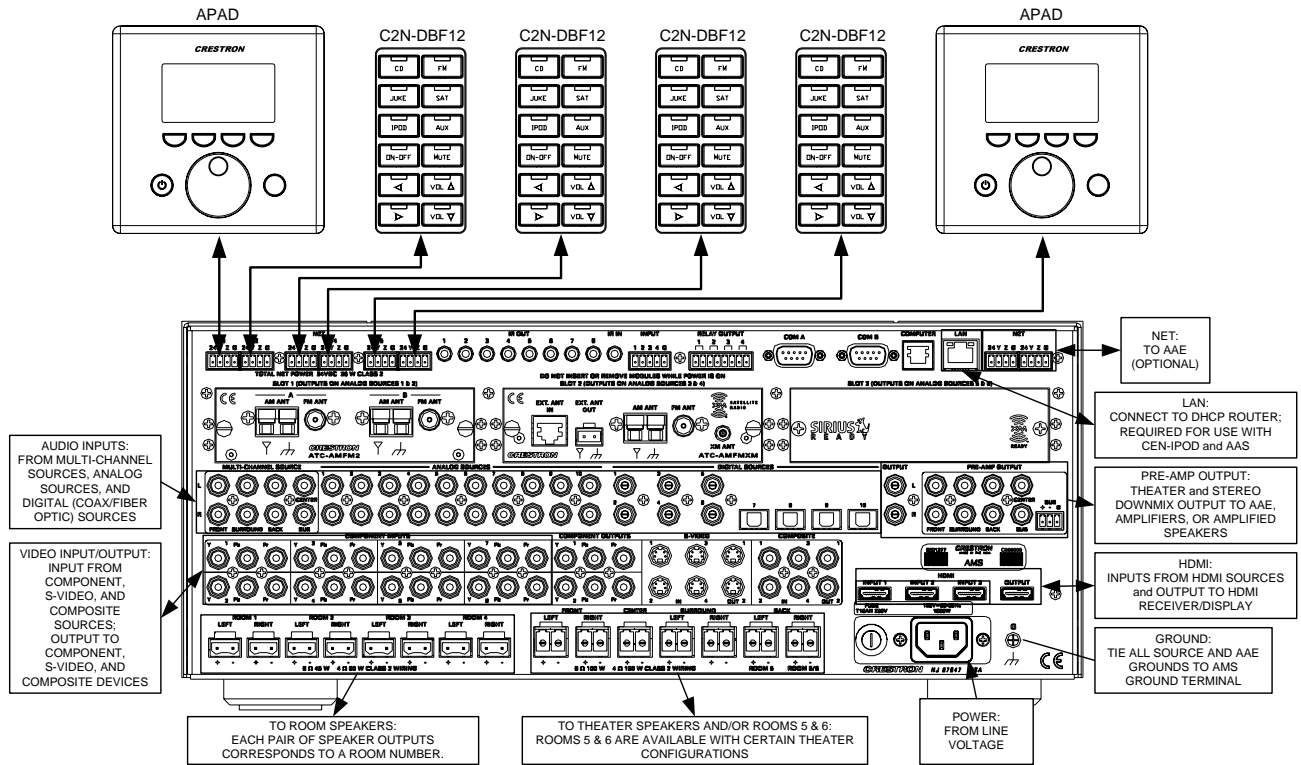

Refer to the following diagram to properly connect devices using an HDMI cable.

Installing and HDMI Cable

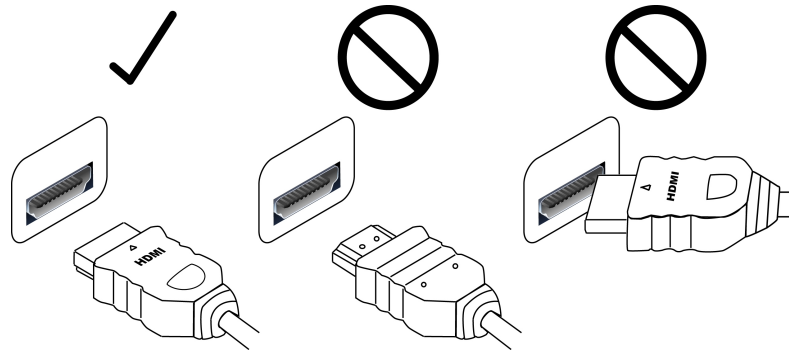

Custom Program Connections

Refer to the following when not using the out-of-the-box functionality:

WARNING: To prevent injury and / or equipment damage due to electric shock, disconnect power from the AMS prior to making any wiring connections.

Make the necessary connections as called out in the illustration that follows this paragraph. Refer to “Network Wiring” on page 20 before attaching the 4-position terminal block connectors. Apply power after all connections have been made.

CAUTION: All tuner cards should be securely installed in the AMS.

CAUTION: Devices such as the AAS and the AAE must be fully grounded to the AMS. Additionally, any other source devices should be grounded to the AMS as well.

NOTE: The AMS can only be powered by the included power cord. Power cannot be supplied from network devices that are connected to the mini-terminal block connectors.

NOTE: The AMSI (International version) requires a power cord that is harmonized to the country's national and local electrical code. Each inner wire in the cord should be at least 16 AWG or (1.5 mm²) and rated for at least 500V. The temperature rating of the cord should be at least 60°C. The cord length should be 1.5 meters to 2 meters.

Custom Program Connections for the AMS (Shown with Tuner Cards in Slots 1 & 2)

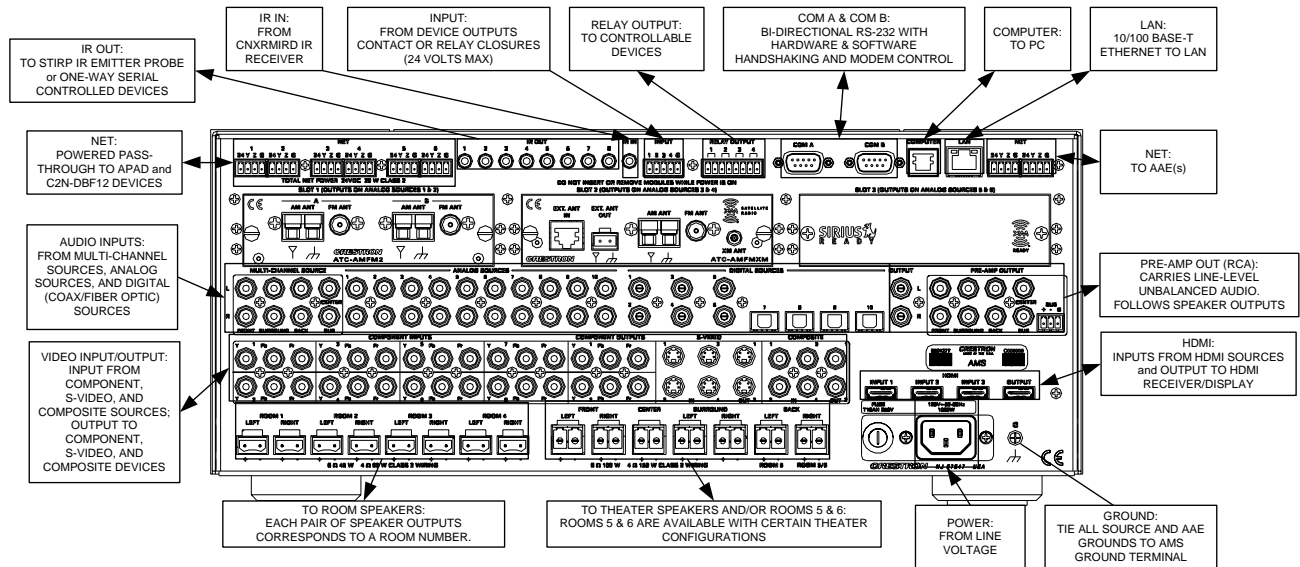

NOTE: A USB port is concealed behind the label cover on the front panel. The USB port is used to connect with a PC and provides a console connection to the AMS. A microphone jack is also concealed behind the front panel's label cover. This jack is used to connect the microphone that is included with the available Crestron Professional Surround Sound Tuning Kit. For more information, refer to the latest version of the Crestron Professional Surround Sound Tuning Kit Operations Guide (Doc. 6565) which can be downloaded from the Crestron website.

Adagio Tuner Cards

If optional Adagio tuner cards are installed, refer to the latest version of the respective tuner card's Installation Guide for information on connecting the required antenna(s).

WARNING: Tuner cards must not be installed or removed when the AMS is connected to AC power. Failure to disconnect AC power prior to installing or removing tuning cards may damage the AMS or the tuner card(s).

NOTE: If using the AMS' out-of-the-box functionality, only two tuner cards can be installed. The tuner cards must be installed in slots 1 and 2.

Source input ports 1 and 2 are unavailable for other sources when a tuner card is installed in slot 1. Source input ports 3 and 4 are unavailable for other sources when a tuner card is installed in slot 2. Source input ports 5 and 6 are unavailable for other sources when a tuner card is installed in slot 3.

When tuner cards are installed in an AMS that is connected to an AAE, loop-through output ports 1 through 6 on the AMS are connected to source input ports 1 through 6 on the AAE.

AMS Control Devices

Any combination of six AMS control devices such as the APAD or the C2N-DBF12 can be simultaneously connected to the powered **NET** ports located on the upper-left side of the rear panel. An additional APAD can also be connected to a **NET** port for control of the theater room. Refer to the following diagram and "Network Wiring" on page 20 for wiring information when connecting either APAD devices or C2N-DBF12 keypads.

AMS with Control Devices

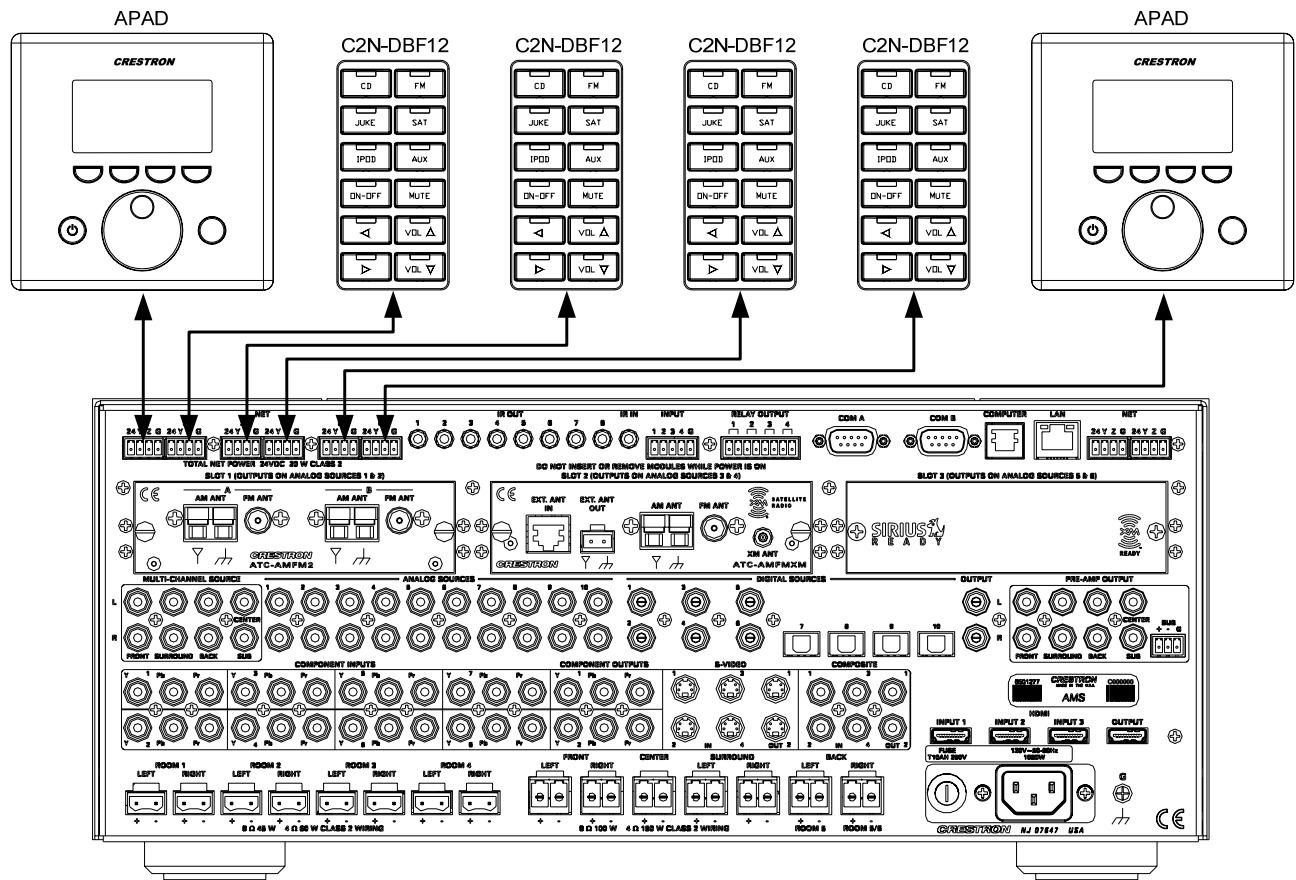

NOTE: The APAD and AMS front panel are the only control devices that can control the theater room when using the out-of-the box functionality.

Theater Calibration

The speakers in the theater room can be calibrated with the Crestron Professional Surround Sound Tuning Kit to compensate for the interaction of the loudspeaker with the room. For more information, refer to the Crestron Professional Surround Sound Tuning Kit Operations Guide (Doc. 6565).

Fuse Replacement

If the AMS does not power up when it is plugged into an AC outlet, the fuse may need to be replaced. The fuse holder is located on bottom-right of the rear panel (next to the power cord connector). To replace the fuse:

- Press **ALL OFF** to turn off all of the outputs.
- Disconnect power to the AMS.
- Use a flat-head screwdriver to push in the fuse holder.
- While pushing in the fuse holder, turn screwdriver counterclockwise until the fuse holder pops out.
- Remove the fuse from the fuse holder and insert a new fuse.

CAUTION: Only use the specified type of fuse when replacing a blown fuse. Failure to do so may cause damage to the AMS.

AMS MODEL	REQUIRED FUSE TYPE
AMS (US & Canada)	T10AH (¼" x 1¼", 250V, 10A, time-lag, high-rupture rated)
AMS (International/220-240 VAC)	T5AH (5mm x 20mm, 250V, 5A, time-lag, high-rupture rated)

- Insert the fuse holder into the AMS.
- Push in the fuse holder with a flat head screwdriver. While pushing in the fuse holder, turn the screwdriver clockwise until the fuse holder sinks in.
- Push in the fuse holder a little further and turn the screwdriver clockwise until the fuse holder locks in place.
- Connect power to the AMS.

Room & Function Button Labels

The AMS comes with three sets of pre-printed labels for the room and theater source buttons. When using the out-of-the box functionality, choose one of the label sets shown below. The appropriate label set must be used for the audio configuration that was specified during the AMS setup procedure described on page 44.

Labels for Four-Room Distributed Audio

Left

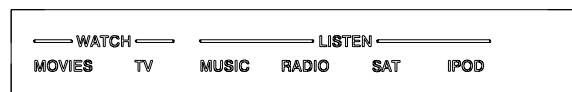

Right

Labels for Five-Room Distributed Audio

Left



Right

Labels for Six-Room Distributed Audio



Left



Right

Adagio Composer or Crestron Engraver software can also be used to create and print custom labels on overhead transparency film for the AMS' room buttons and function buttons.

NOTE: When printing custom labels, some experimentation may be required for optimum results.

Custom-engraved labels can also be ordered from Crestron. Contact Crestron for more information.

To remove the label:

1. Remove the label cover with a small, flat-head screwdriver. The label cover is magnetically attached to the front panel of the Adagio component. The label strip will be exposed.
2. Insert the screwdriver behind the label strip as shown in the diagram below.



- Continue sliding the screwdriver behind the label strip until the top of the label strip slides out as shown in the following picture.



- Continue sliding the screwdriver until the entire top of the label strip is visible. Remove the label strip by pulling the top of the label strip up from the Adagio component as shown in the following picture.



To install the new label:

- Engraved Label Cover: Place the engraved label cover over the label area of the Adagio component until the label cover's integrated magnets snap the label cover into place.
- Printed Label: Place the bottom of the label strip into the Adagio component. Bend the label strip and position the top of the label strip into the Adagio component. Replace the label cover over the new label strip.

NOTE: Observe proper orientation so the letters are right-side up.

Configuration

After making all hardware connections to the AMS, the system must be configured for operation.

Configuring the system is broken down into four processes:

- Configure the AMS for Operation
- Configure Sources
- Configure Rooms
- Configure Preset Groups

Configure the AMS for Operation

The AMS must be configured for operation prior to configuring sources, rooms, or groups. Use the Installer Tools to configure the AMS for operation.

NOTE: If a custom program was created with Adagio Composer or SystemBuilder, the following is not required.

Open Installer Tools

- Press and hold the **ROOM** and **SOURCE** buttons for 10 seconds to open the Installer Tools menu.

Installer Tools Menu

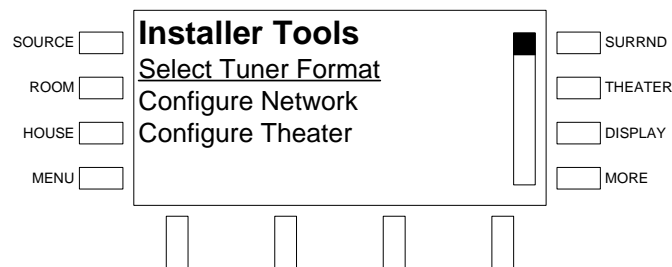

- Scroll through the list of available options using the selection knob. The selected option will be underlined. Available options are:
 - ⇒ **Select Tuner Format** – Specifies the North American or European tuning format when using a tuner card.
 - ⇒ **Configure Network** – Configures the AMS to communicate with devices that are connected to the AMS over Ethernet.
 - ⇒ **Configure Theater** – Configures the layout and function of the theater room.
 - ⇒ **Configure Distributed Audio** - Sets the number of rooms to receive distributed audio from the AMS, allows custom naming of rooms connected to the AMS, allows custom naming of audio sources connected to the AMS, hides sources from the list of available sources, configures 12-button keypads, and restores default settings for distributed audio functions.

- ⇒ **Identify Keypads** – Registers APAD devices and C2N-DBF12 keypads that are connected to the system.
- ⇒ **Load APADs** – Programs all connected APAD devices to work with the AMS.
- ⇒ **About** – Provides information about the AMS such as IP data, firmware version, and program information.

To configure the selected option, press the **ENTER** button.

To exit Installer Tools and save changes to the AMS' configuration, press the **MENU** button.

Select Tuner Format

Select the tuning format to specify the tuning method used by an installed AM/FM tuner. When using the North American tuner format, the tuner will tune FM frequencies in 100 kHz steps and AM frequencies in 10 kHz steps. When using the European tuner format, the tuner will tune FM frequencies in 50 kHz steps and AM frequencies in 9 kHz steps.

- Open Installer Tools as described on page 41, select **Select Tuner Format**, and press the **ENTER** button

Select Tuner Format Menu

SOURCE <input type="checkbox"/>	Select Tuner Format <u>North American</u> European	<input type="checkbox"/> SURRND
ROOM <input type="checkbox"/>		<input type="checkbox"/> THEATER
HOUSE <input type="checkbox"/>		<input type="checkbox"/> DISPLAY
MENU <input type="checkbox"/>		<input type="checkbox"/> MORE
<input type="checkbox"/> <input type="checkbox"/> <input type="checkbox"/> <input type="checkbox"/>		

- Use the selection knob to select a tuner format. To cancel and return to the Installer Tools menu, press the **MENU** button.
- To confirm, press the **ENTER** button and return to the Installer Tools menu.

Configure the Network

The AMS must be configured to recognize devices that communicate over Ethernet (i.e. AAS, CEN-IDOC).

- Open Installer Tools as described on page 41, select **Configure Network**, and press the **ENTER** button.

Configure Network

SOURCE <input type="checkbox"/>	Configure Network Do you want to install a CEN-IDOC in your system? Yes No	<input type="checkbox"/> SURRND
ROOM <input type="checkbox"/>		<input type="checkbox"/> THEATER
HOUSE <input type="checkbox"/>		<input type="checkbox"/> DISPLAY
MENU <input type="checkbox"/>		<input type="checkbox"/> MORE
	<input type="checkbox"/> <input type="checkbox"/> <input type="checkbox"/> <input type="checkbox"/>	

- To install a CEN-IDOC, press the soft button labeled **Yes** and follow the instructions onscreen. Otherwise, press the soft button labeled **No**. The name of the CEN-IDOC will be used in place of “Source 5” in the list of sources.

After installing the CEN-IDOC, there will be a prompt asking to assign the CEN-IDOC to a theater source. Press the soft button labeled **Yes** to accept the source assignment or press the soft button labeled **No** to skip the source assignment. A source assignment can be chosen while configuring the theater. Refer to “Configure the Theater” below for more information.

- To install an AAS, press the soft button labeled **Yes** and follow the instructions onscreen. Otherwise, press the soft button labeled **No**. The source names will be renamed as follows:
 - ⇒ Source 7 becomes “Server 1”^{1,2}
 - ⇒ Source 8 becomes “Server 2”^{1,2}
 - ⇒ Source 9 becomes “Server 3”²
 - ⇒ Source 10 becomes “Server 4”²

1: AAS-2 model

2: AAS-4 model

NOTE: When installing an AAS, only one AAS can be present on the network.

After installing the AAS, there will be a prompt asking to assign the outputs of the AAS to theater sources. Press the soft button labeled **Yes** to accept the presented source assignments or press the soft button labeled **No** to skip the source assignment. A source assignment can be chosen while configuring the theater. Refer to “Configure the Theater” below for more information.

- Press **MENU** to return to the Installer Tools menu.

Configure the Theater

The theater room must be configured to match the theater’s speaker arrangement and to designate sources for each theater function. This is done through the Configure Theater menu.

- Open Installer Tools as described on page 41, select **Configure Theater**, and press the **ENTER** button.

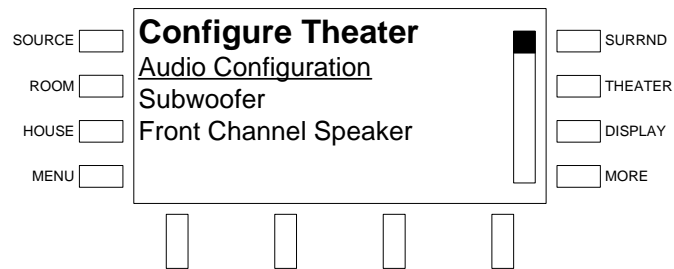
Configure Theater Menu

- Select **Audio Configuration** and press **ENTER** to set the theater room's speaker configuration.
- Select **Subwoofer** and press **ENTER** to open controls for enabling and disabling the subwoofer output.
- Select **Front Center Speaker** and press **ENTER** to open controls for enabling and disabling the front center speaker output.
- Select **Inputs** and press **ENTER** to open controls for configuring each theater function.
- Select **Restore Defaults** to return the theater configuration to the default settings.
- Press **MENU** to return to the Installer Tools menu.

Audio Configuration

Set the correct speaker configuration for the theater room and rooms receiving distributed audio.

- Open Installer Tools as described on page 41, select **Configure Theater**, and press the **ENTER** button.
- Turn the selection knob to select **Audio Configuration** and press the **ENTER** button.

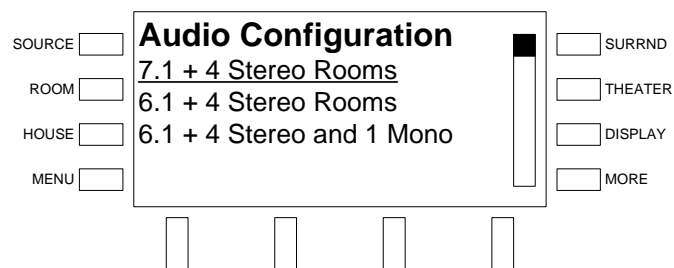
Audio Configuration List

- Turn the selection knob to select the desired audio configuration. A description of each audio configuration and its required speaker connections begins on page 20. To cancel and return to the Configure Theater menu, press **MENU**.

NOTE: If the pre-printed labels are to be used, select the proper label strips as described on page 38.

NOTE: Additional rooms that receive distributed audio from an AMS are configured on page 49. Additional rooms that receive distributed audio from an AAE are configured on page 49.

- To confirm, press the **ENTER** button and return to the Configure Theater menu.

Subwoofer

Enable or disable the subwoofer output from the Subwoofer controls.

- Open Installer Tools as described on page 41, select **Configure Theater**, and press the **ENTER** button.
- Turn the selection knob to select **Subwoofer** and press the **ENTER** button to open the Subwoofer control.

Subwoofer Control

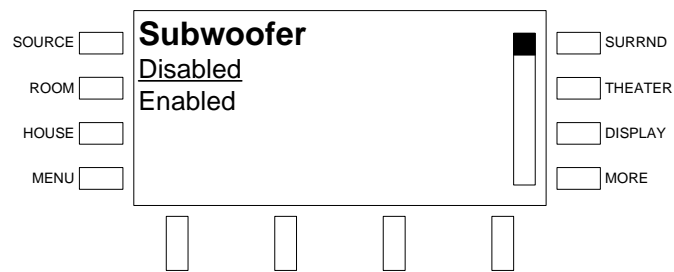

- Turn the selection knob to select **Enabled** or **Disabled** to enable or disable the subwoofer output. To cancel and return to the Configure Theater menu, press **MENU**.
- To confirm, press the **ENTER** button and return to the Configure Theater menu.

Front Center Speaker

Enable or disable the front center speaker output from the Front Center Speaker controls.

- Open Installer Tools as described on page 41, select **Configure Theater**, and press the **ENTER** button.
- Turn the selection knob to select **Front Center Speaker** and press the **ENTER** button to open the Front Center Speaker control.

Front Center Speaker Control

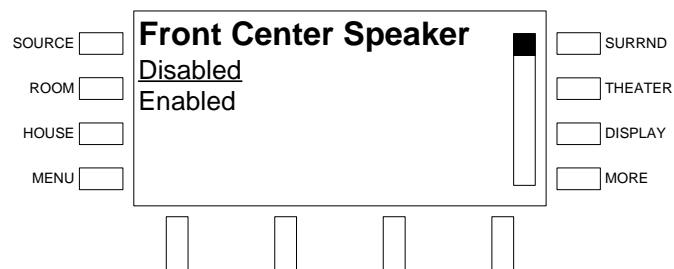

- Turn the selection knob to select **Enabled** or **Disabled** to enable or disable the front center speaker output. To cancel and return to the Configure Theater menu, press **MENU**.
- To confirm, press the **ENTER** button and return to the Configure Theater menu.

Inputs

Sources in the theater are selected from any one of 27 “virtual” theater inputs. A virtual theater input is a combination of video and audio inputs. A virtual theater input can also be configured as “video only” (no audio component), or “audio only” (no video component). Each virtual theater input is assigned a number that is shown in the list of virtual inputs. The numbers do not correspond to any of the input numbers labeled on the back of the AMS. For example, Virtual Theater Input 3 can be configured as a source named “DVD”, receives audio from “Digital Input 2” and component video from the “Component 6” input.

Virtual theater inputs 1 through 6 are assigned to the theater source buttons. Depending on the audio configuration specified on page 44, up to six of the theater source buttons may be used to select a virtual theater input.

To configure a virtual theater input:

- Open Installer Tools as described on page 41, select **Configure Theater**, and press the **ENTER** button.
- Turn the selection knob to select **Inputs** and press the **ENTER** button to open the Inputs control.

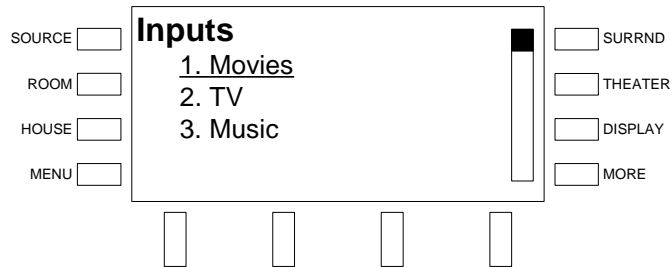
Inputs Control

- Turn the selection knob to select a virtual theater input and press the **ENTER** button. The settings for the selected virtual theater input will be displayed.

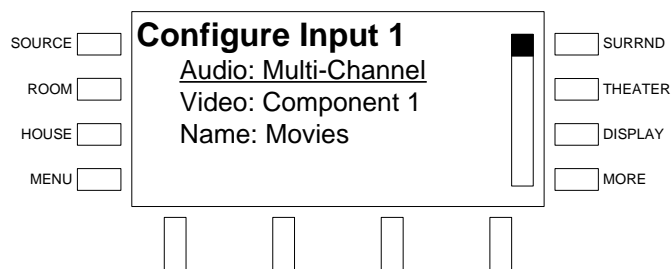
Theater Function Settings

⇒ Set the Audio Source:

- ❖ Turn the selection knob to select **Audio** and press the **ENTER** button. The current setting will be bracketed as shown in the following diagram.

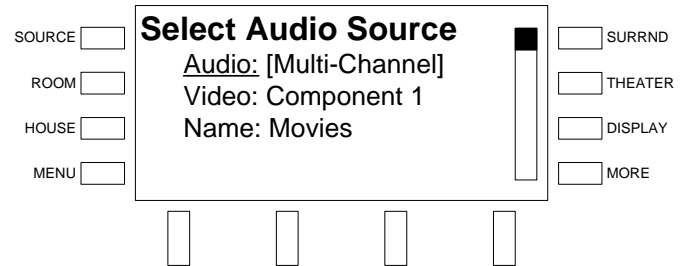
Select Audio Source for Theater Function

- ❖ Turn the selection knob to select the audio source to be used and press the **ENTER** button. To cancel, press the **MENU** button.

⇒ Set the Video Source:

- ❖ Turn the selection knob to select **Video** and press the **ENTER** button. The current setting will be bracketed as shown in the following diagram.

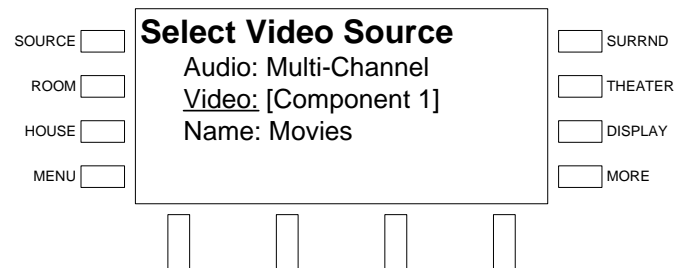
Select Video Source for Theater Function

- ❖ Turn the selection knob to select the video source to be used and press the **ENTER** button. To cancel, press the **MENU** button.

NOTE: The selected source will be routed to the corresponding output(s). For example, selecting, composite input 1 will route the video signal to composite outputs 1 and 2.

⇒ Name the virtual theater input:

- ❖ Turn the selection knob to select **Name** and press the **ENTER** button. A cursor will appear next to the current name and controls for changing the name will also be displayed. To cancel, press the **MENU** button.

Enter Name of Virtual Theater Input

SOURCE <input type="checkbox"/>	Enter Input 1 Name Audio: Multi-Channel Video: [Component 1] Name: Movies█ Del < > Done	<input type="checkbox"/> SURRND
ROOM <input type="checkbox"/>		<input type="checkbox"/> THEATER
HOUSE <input type="checkbox"/>		<input type="checkbox"/> DISPLAY
MENU <input type="checkbox"/>		<input type="checkbox"/> MORE

- ❖ Select letters (upper and lower-case), numbers, or other characters by turning the selection knob until the desired letter, number, or other character is displayed on the LCD. Move the cursor to another position by pressing the soft buttons labeled ◀ and ▶. To delete a character, press the soft button marked **Del**.

NOTE: The maximum length for any virtual theater input name is 16 characters.

- ❖ After entering the new name, press **Done** to save the name and return to the list of sources.
- Once all of the parameters have been set, press the **MENU** button to return to the list of virtual theater inputs.
- Repeat the previous steps for each virtual theater input.

Restore Defaults

The theater configuration can be restored to its default factory settings from the front panel.

- Open Installer Tools as described on page 41, select **Configure Theater**, and press the **ENTER** button.
- Turn the selection knob to select **Restore Defaults** and press the **ENTER** button to open the Restore Defaults control.

Restore Defaults Warning

SOURCE <input type="checkbox"/>	Restore Defaults All Theater source and audio settings will be reset. Continue? Yes No	<input type="checkbox"/> SURRND
ROOM <input type="checkbox"/>		<input type="checkbox"/> THEATER
HOUSE <input type="checkbox"/>		<input type="checkbox"/> DISPLAY
MENU <input type="checkbox"/>		<input type="checkbox"/> MORE

- Press the soft button labeled **Yes** to proceed and restore the default settings or press **No** to cancel.

Configure Distributed Audio

The AMS must be configured for distributing audio to connected rooms. This is done through the Distributed Audio menu.

- Open Installer Tools as described on page 41, select **Configure Distributed Audio**, and press the **ENTER** button.

Distributed Audio Menu

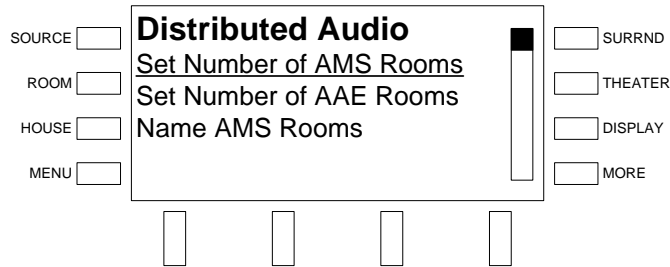

Set the Number of AMS Rooms

Set the number of rooms that will be connected to the AMS so the front panel does not display unused rooms during configuration and operation.

- Open Installer Tools as described on page 41, select **Configure Distributed Audio**, and press the **ENTER** button.
- Turn the selection knob to select **Set Number of AMS Rooms**, and press the **ENTER** button.

Set the Number of AMS Rooms

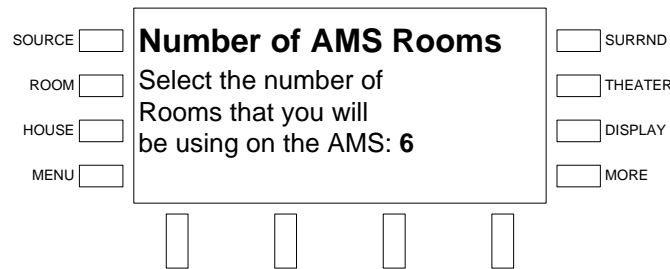

- Use the selection knob to select the number of rooms that will be connected to the AMS. To cancel and return to the Installer Tools menu, press **MENU**.

NOTE: The number of available rooms is limited by the theater configuration specified on page 44.

- To confirm, press the **ENTER** button and return to the Distributed Audio menu.

Set the Number of AAE Rooms

Set the number of rooms that will be connected to the AMS through an AAE so the front panel does not display unused rooms during configuration and operation.

- Open Installer Tools as described on page 41, select **Configure Distributed Audio**, and press the **ENTER** button.
- Turn the selection knob to select **Set Number of AAE Rooms**, and press the **ENTER** button.

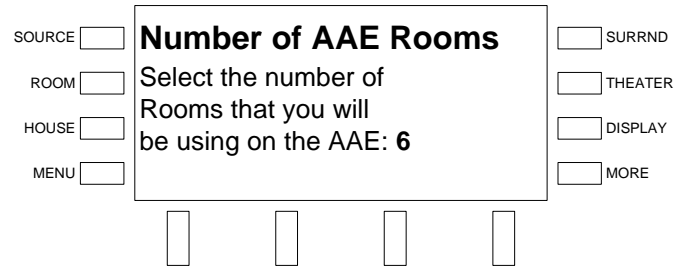
Set the Number of AAE Rooms

- Use the selection knob to select the number of rooms that will be connected to the AMS through an AAE. To cancel and return to the Installer Tools menu, press **MENU**.
- To confirm, press the **ENTER** button and return to the Distributed Audio menu.

Name AMS Rooms

This screen allows you to customize the displayed name of rooms connected to the AMS.

- Open Installer Tools as described on page 41, select **Configure Distributed Audio**, and press the **ENTER** button.
- Turn the selection knob to select **Name AMS Rooms**, and press the **ENTER** button.

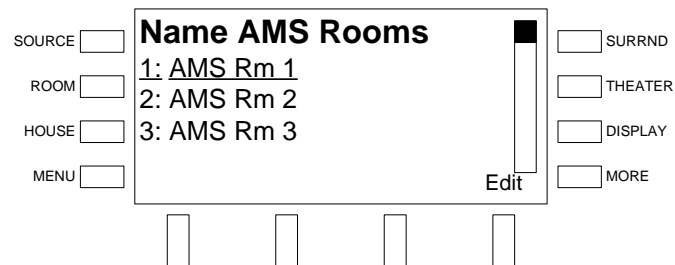
Select AMS Room to Name

- Turn the selection knob to select the room to be named and press the soft button labeled **Edit** (or press the **ENTER** button). To cancel and return to the Installer Tools menu, press **MENU**.
- To use one of the factory-installed names, turn the selection knob clockwise or counterclockwise to display the desired room name and press **ENTER**.
- To enter a custom name, turn the selection knob until [**Custom Name**] is displayed and press **ENTER**.

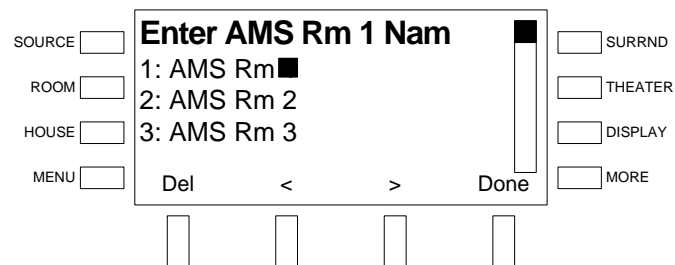
Edit Room Name

- ⇒ Select letters (upper and lower-case), numbers, or other characters by turning the selection knob until the desired letter, number, or other character is displayed on the LCD. Move the cursor to another position by pressing the soft buttons labeled **<** and **>**. To delete a character, press the soft button marked **Del**.

NOTE: The maximum length for any room name is 16 characters.

- ⇒ After entering the new room name, press **Done** to save the name and return to the list of room names.
- Rename other rooms if desired. If all of the rooms have been named/renamed, press **MENU** to return to the Distributed Audio menu.

Name AAE Rooms

This screen allows you to customize the displayed name of rooms connected to an AMS through an AAE.

- Open Installer Tools as described on page 41, select **Configure Distributed Audio**, and press the **ENTER** button.
- Turn the selection knob to select **Name AAE Rooms**, and press the **ENTER** button.

Select AAE Room to Name

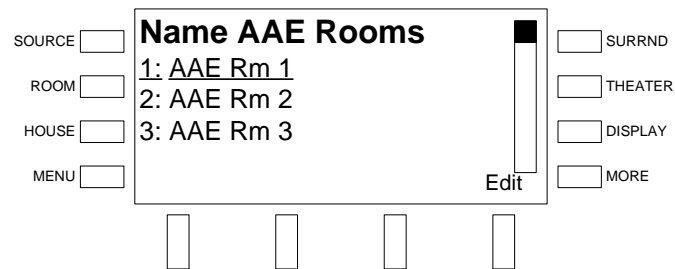

Turn the selection knob to select the room to be named and press the soft button labeled **Edit** (or press the **ENTER** button). To cancel and return to the Installer Tools menu, press **MENU**.

- To use one of the factory-installed names, turn the selection knob clockwise or counterclockwise to display the desired room name and press **ENTER**.
- To enter a custom name, turn the selection knob until **[Custom Name]** is displayed and press **ENTER**.

Edit Room Name

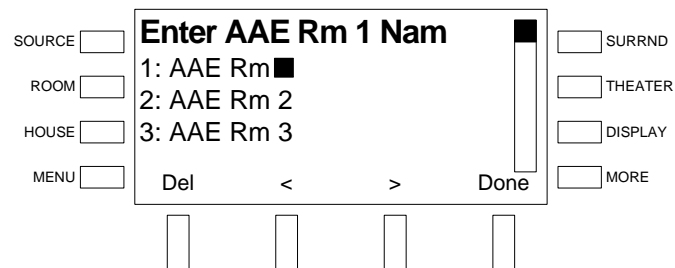

- ⇒ Select letters (upper and lower-case), numbers, or other characters by turning the selection knob until the desired letter, number, or other character is displayed on the LCD. Move the cursor to another position

by pressing the soft buttons labeled ◀ and ▶. To delete a character, press the soft button marked **Del**.

NOTE: The maximum length for any room name is 16 characters.

⇒ After entering the new room name, press **Done** to save the name and return to the list of room names.

- Rename other rooms if desired. If all of the rooms have been named/renamed, press **MENU** to return to the Distributed Audio menu.

Set AAE Theater Source

So rooms connected to the AAE can receive the theater downmix, an analog audio input on the AAE must be designated to receive the theater downmix from the AMS.

- Open Installer Tools as described on page 41, select **Configure Distributed Audio**, and press the **ENTER** button.
- Turn the selection knob to select **Set AAE Theater Source**, and press the **ENTER** button.

Set AAE Theater Source

- Turn the selection knob to display the AAE input to use and press the **ENTER** button.

NOTE: The default setting is input number 6 since the input is not used by the tuner cards, CEN-IDOC, or AAS.

Name Sources

This screen allows you to customize the name of each of the analog sources that are displayed on the LCD.

- Open Installer Tools as described on page 41, select **Configure Distributed Audio**, and press the **ENTER** button.
- Turn the selection knob to select **Name Sources**, and press the **ENTER** button.

Select Source to Name

- Turn the selection knob to select the source to be named and press the soft button labeled **Edit** (or press the **ENTER** button). To cancel and return to the Installer Tools menu, press **MENU**.

NOTE: If a source is designated as the AAE theater source, it cannot be renamed.

- To use one of the factory-installed names, turn the selection knob clockwise or counterclockwise to display the desired source name and press **ENTER**.
- To enter a custom name, turn the selection knob until **[Custom Name]** is displayed and press **ENTER**.

Edit Source Name

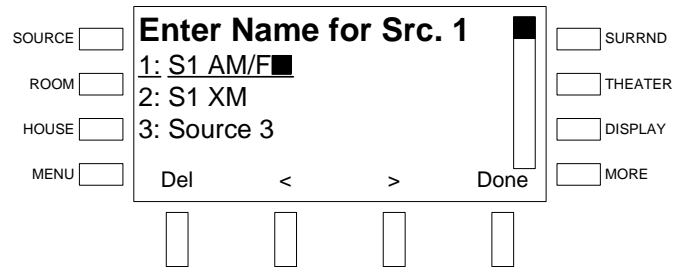

- ⇒ Select letters (upper and lower-case), numbers, or other characters by turning the selection knob until the desired letter, number, or other character is displayed on the LCD. Move the cursor to another position by pressing the soft buttons labeled **<** and **>**. To delete a character, press the soft button marked **Del**.

NOTE: The maximum length for any source name is 16 characters.

- ⇒ After entering the new source name, press **Done** to save the name and return to the list of sources.
- Rename other sources if desired. If all of the sources have been named/renamed, press **MENU** to return to the Distributed Audio menu.

Hide Sources

This screen allows you to hide sources from the list of available sources. This screen also allows you to reveal sources that were previously hidden.

- Open Installer Tools as described on page 41, select **Configure Distributed Audio**, and press the **ENTER** button.
- Turn the selection knob to select **Hide Sources**, and press the **ENTER** button.

Hide Sources

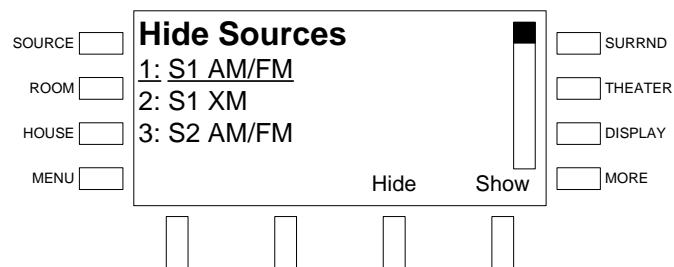

NOTE: The source that is designated as the AAE theater source is automatically hidden, it cannot be unhidden.

- To hide a source, turn the selection knob to select the source to be hidden and press the soft button labeled **Hide**. Hidden sources are indicated with an asterisk (*). After all of the sources to be hidden are designated as such, press **MENU** to return to the Distributed Audio menu.
- To make a source visible, turn the selection knob to select the source to be made visible and press the soft button labeled **Show**. After all of the sources to be shown are designated as such, press **MENU** to return to the Distributed Audio menu.

Configure Keypads

This screen allows you to assign sources to the top six keys of a C2N-DBF12 keypad. The source assignment is applied to every C2N-DBF12 keypad that is connected to the system. The functions of the bottom six keys cannot be changed when using the out-of-the-box program.

- Open Installer Tools as described on page 41, select **Configure Distributed Audio**, and press the **ENTER** button.
- Turn the selection knob to select **Configure Keypads**, and press the **ENTER** button.

Select Button To Map

- Turn the selection knob to select the button to be mapped and press the **ENTER** button or the soft button labeled **Edit**. To cancel and return to the Installer Tools menu, press **MENU**.

Select Source for Button and Button Layout

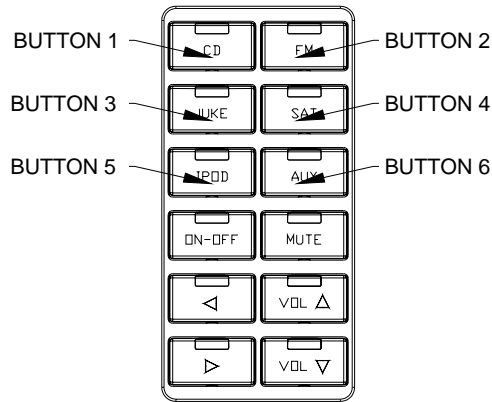

- Select the source for the button by turning the selection knob until the desired source is displayed on the LCD. If a button is not to be used, select **Not Used**.
- After selecting the source, press the **ENTER** button to save the assignment and return to the list of buttons.
- Assign other buttons if desired. If all of the buttons have been assigned/reassigned, press **MENU** to return to the Distributed Audio menu.

Restore Default Settings

The AMS can be restored to its default factory settings from the front panel. All settings that have been made with Installer Tools, as well as room and source audio settings will be reset to their factory defaults.

- Open Installer Tools as described on page 41, select **Configure Distributed Audio**, and press the **ENTER** button.
- Turn the selection knob to select **Restore Defaults**, and press the **ENTER** button.

Restore Defaults Warning

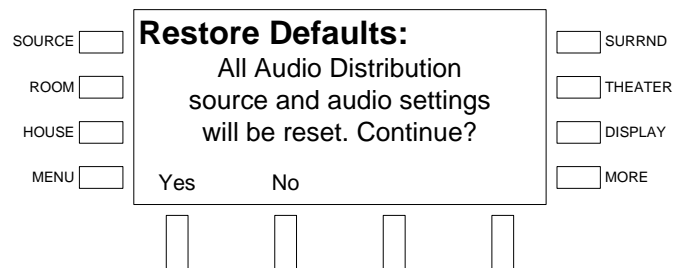

- Press the soft button labeled **Yes** to proceed and restore the default settings or press **No** to cancel.

Identify Keypads

This screen allows you to identify keypads and APAD devices that are connected to the AMS.

- Open Installer Tools as described on page 41, select **Identify Keypads**, and press the **ENTER** button.

NOTE: Any attached AAE will automatically be identified by the AMS during this step.

Identify Keypads Warning

SOURCE <input type="checkbox"/>	Identify Keypads Warning: All keypads will need to be re-identified Continue? Yes No	<input type="checkbox"/> SURRND
ROOM <input type="checkbox"/>		<input type="checkbox"/> THEATER
HOUSE <input type="checkbox"/>		<input type="checkbox"/> DISPLAY
MENU <input type="checkbox"/>		<input type="checkbox"/> MORE
	<input type="checkbox"/> <input type="checkbox"/> <input type="checkbox"/> <input type="checkbox"/>	

- Press the soft button labeled **Yes** to proceed and clear previously stored keypad identification data or press **No** to cancel.
- The keypad for the theater is the first to be identified to the AMS.

NOTE: When using the out-of-the-box functionality, the theater room can only use an APAD or the front panel for control as shown in the following diagram.

Select Keypad Type for Theater

SOURCE <input type="checkbox"/>	Identify Keypads Select keypad type for Theater APAD None	<input type="checkbox"/> SURRND
ROOM <input type="checkbox"/>		<input type="checkbox"/> THEATER
HOUSE <input type="checkbox"/>		<input type="checkbox"/> DISPLAY
MENU <input type="checkbox"/>		<input type="checkbox"/> MORE
	<input type="checkbox"/> <input type="checkbox"/> <input type="checkbox"/> <input type="checkbox"/>	

- Press the appropriate soft button to select the control device type (APAD or None) for the theater. If there is no control device for that room, press the soft button labeled **None**.

NOTE: If **None** is selected, the theater room can only be controlled from the front panel of the AMS.

- Follow the onscreen instructions for identifying the device. After the keypad for the theater has been identified, the AMS will continue the identification process for the other rooms.

Select Keypad Type

SOURCE <input type="checkbox"/>	Identify Keypads Select keypad type for Room 1 APAD 12But None	<input type="checkbox"/> SURRND
ROOM <input type="checkbox"/>		<input type="checkbox"/> THEATER
HOUSE <input type="checkbox"/>		<input type="checkbox"/> DISPLAY
MENU <input type="checkbox"/>		<input type="checkbox"/> MORE
	<input type="checkbox"/> <input type="checkbox"/> <input type="checkbox"/> <input type="checkbox"/>	

- Press the appropriate soft button to select the control device type (APAD or keypad) for the first room controlled by the AMS (Room Output 1). If there is no control device for that room, press the soft button labeled **None**.

- Follow the onscreen instructions for identifying the device. After identifying the device, the AMS will prompt for the next room's control device.

NOTE: If a device is not identified within two minutes, the AMS will indicate that the keypad was not found. Try again by pressing the soft button labeled **Yes** or cancel the process by selecting the soft button labeled **Abort**.

- Repeat the procedure until control devices for all of the specified rooms (refer to page 49) have been identified.
- Press **MENU** to return to the Installer Tools menu.

Load APADs

APAD devices may need to be programmed to work with the AMS. If a connected APAD does not display controls for the AMS, perform the following:

- Open Installer Tools as described on page 41, select **Load APADs**, and press the **ENTER** button.

Load APADs Warning

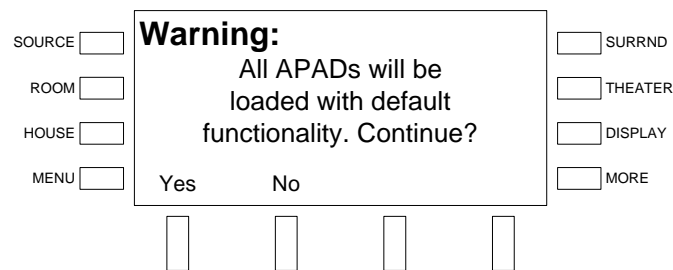

- Press the soft button labeled **Yes** to proceed and load the required files to connected APADs or press **No** to cancel.

About

This screen allows you to view information about the AMS.

- Open Installer Tools as described on page 41, select **About**, and press the **ENTER** button. The IP address, IP mask, and Hostname of the AMS are displayed on the LCD.

About

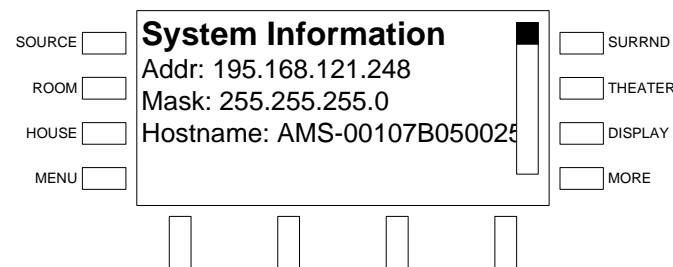

- Turn the selection knob to display additional information.
- Press **MENU** to return to the Installer Tools menu.

Configure Sources

The gain of each analog source and the theater downmix can be customized from the AMS control panel.

To adjust a source's gain:

- Select a source to adjust by pressing **SOURCE** and using the selection knob to select a source.
- Press and hold the **SOURCE** and **MORE** buttons at the same time to open the Gain control. The soft button labels will change to show the available control option.

Source Setup Menu

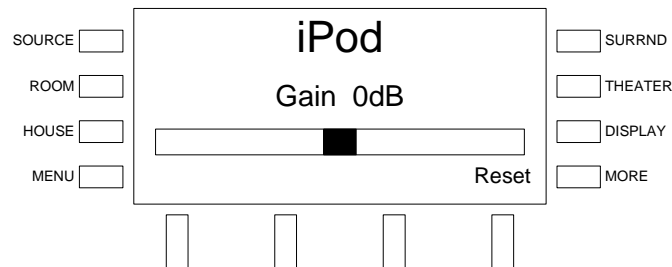

- Adjust the gain level with the selection knob. Turn clockwise to raise the gain level or counterclockwise to lower the gain level. Press the soft button labeled **Reset** to set the gain level to 0dB.
- Press **MENU** to exit.

Configure Rooms

The sound quality, minimum volume, maximum volume and startup volume settings, of each room can be customized from the AMS control panel.

Access the Room Setup Mode

- Select a room to configure by pressing a room button. Alternatively, press **ROOM** and select the room with the selection knob.
- Press and hold the **ROOM** and **MORE** buttons at the same time for approximately five seconds to open the Room Setup menu. The soft button labels will change to show the available control options.

Room Setup Menu

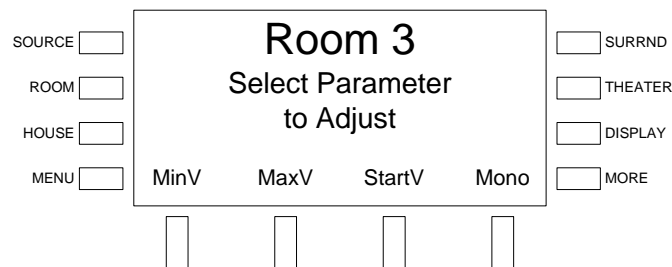

Parameters that can be adjusted include:

- ⇒ Minimum Volume
- ⇒ Maximum Volume

- ⇒ Startup Volume
- ⇒ Mono/Stereo

Adjustments for Bass, Treble, Balance, and Loudness are made while in the *Room* mode as described on page 92.

Adjust the Minimum Volume

The minimum volume establishes the lowest volume level setting for a room. The minimum volume settings of each room can be adjusted independently.

- Access the *Room Setup* mode as described on page 58.
- Press the soft button labeled **MinV** to open the Minimum Volume control.

Minimum Volume Control

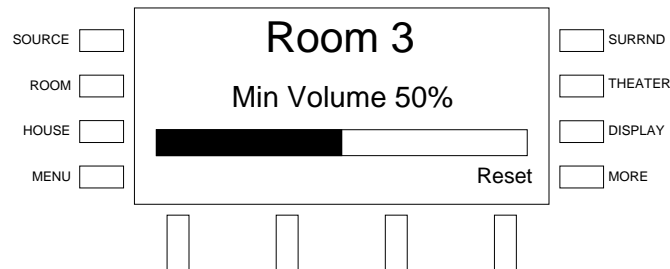

- Adjust the minimum volume with the selection knob. Turn clockwise to raise the minimum volume or counterclockwise to lower the minimum volume. The highest minimum volume setting is 50%. Press the soft button labeled **Reset** to set the volume level to 5%.

NOTE: Other rooms can be adjusted by pressing a different room button.

- Press **MENU** to return to the Room Setup menu.

Adjust the Maximum Volume

The maximum volume establishes the highest volume level setting for a room. The maximum volume settings of each room can be adjusted independently.

- Access the *Room Setup* mode as described on page 58.
- Press the soft button labeled **MaxV** to open the Maximum Volume control.

Maximum Volume Control

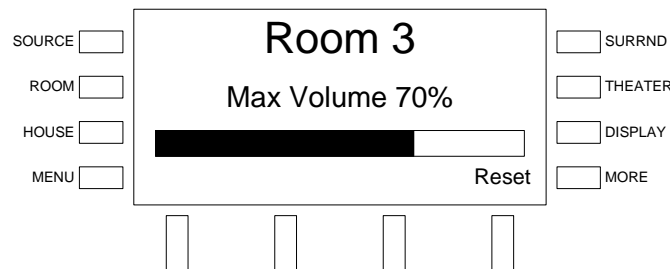

- Adjust the maximum volume with the selection knob. Turn clockwise to raise the maximum volume or counterclockwise to lower the maximum volume. The lowest maximum volume setting is 70%. Press the soft button labeled **Reset** to set the volume level to 100%.

NOTE: Other rooms can be adjusted by pressing a different room button.

- Press **MENU** to return to the Room Setup menu.

Adjust the Startup Volume

The startup volume establishes the volume level setting for a room when a room is turned on. The startup volume settings of each room can be adjusted independently.

- Access the *Room Setup* mode as described on page 58.
- Press the soft button labeled **StartV** to open the Startup Volume control.

Startup Volume Control

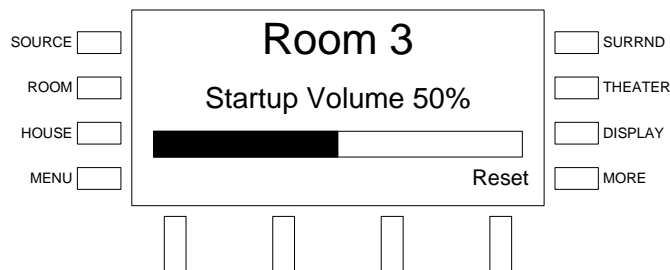

- Adjust the startup volume with the selection knob. Turn clockwise to raise the startup volume or counterclockwise to lower the startup volume. The maximum startup volume setting is 50%. Press the soft button labeled **Reset** to set the volume level to 30%.

NOTE: Other rooms can be adjusted by pressing a different room button.

- Press **MENU** to return to the Room Setup menu.

Set Mono or Stereo Mode

The audio sent to the speakers in each room can be set for either stereo or mono. When set to stereo, the audio signal is separated into left and right channels for distribution to left and right speakers. When set to mono, the audio signal is combined into one signal for use in larger rooms where stereo separation is not practical. The mono/stereo settings of each room can be adjusted independently.

- Access the *Room Setup* mode as described on page 58.
- Press the soft button labeled **Mono** to open the Stereo/Mono control.

Stereo/Mono Control

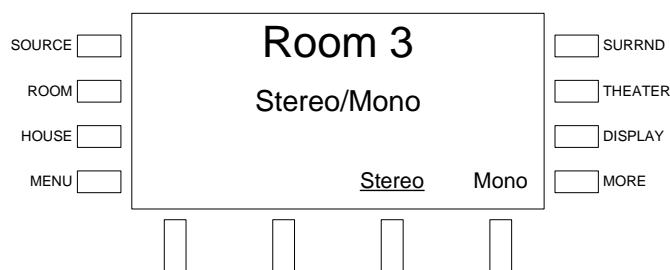

- The selected mode is underlined on the lower-right side of the LCD. Press the soft button labeled **Stereo** to select the *Stereo* mode. Press the soft button labeled **Mono** to select the *Mono* mode.

NOTE: Other rooms can be adjusted by pressing a different room button.

- Press **MENU** to return to the Room Setup menu.

Configure Theater

The sound quality, minimum volume, maximum volume and startup volume settings, of the theater can be customized from the AMS control panel.

Access the Theater Setup Menu

- Press the **THEATER** button to select the theater.
- Press the **THEATER** and **MORE** buttons at the same time to open the Theater Setup menu. The soft button labels will change to show the available control options.

Theater Setup Menu

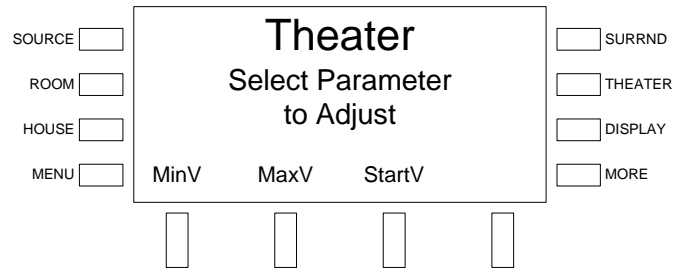

Parameters that can be adjusted include:

- ⇒ Minimum Volume
- ⇒ Maximum Volume
- ⇒ Startup Volume

Adjustments for Bass, Treble, Balance, and Loudness are made while in the *Theater* mode as described on page 65.

Adjust the Minimum Volume

The minimum volume establishes the lowest volume level setting for the theater.

- Access the Theater Setup menu as described on page 61.
- Press the soft button labeled **MinV** to open the Minimum Volume control.

Minimum Volume Control

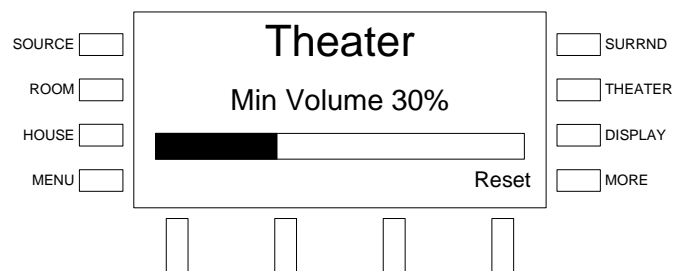

- Adjust the minimum volume with the selection knob. Turn clockwise to raise the minimum volume or counterclockwise to lower the minimum volume. The highest minimum volume setting is 50%. Press the soft button labeled **Reset** to set the volume level to 5%.
- Press **MENU** to return to the Theater Setup menu.

Adjust the Maximum Volume

The maximum volume establishes the highest volume level setting for the theater.

- Access the Theater Setup menu as described on page 61.
- Press the soft button labeled **MaxV** to open the Maximum Volume control.

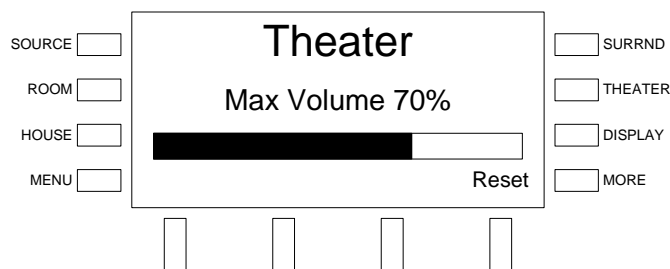
Maximum Volume Control

- Adjust the maximum volume with the selection knob. Turn clockwise to raise the maximum volume or counterclockwise to lower the maximum volume. The lowest maximum volume setting is 70%. Press the soft button labeled **Reset** to set the volume level to 100%.
- Press **MENU** to return to the Theater Setup menu.

Adjust the Startup Volume

The startup volume establishes the volume level setting for the theater when the theater is turned on.

- Access the Theater Setup menu as described on page 61.
- Press the soft button labeled **StartV** to open the Startup Volume control.

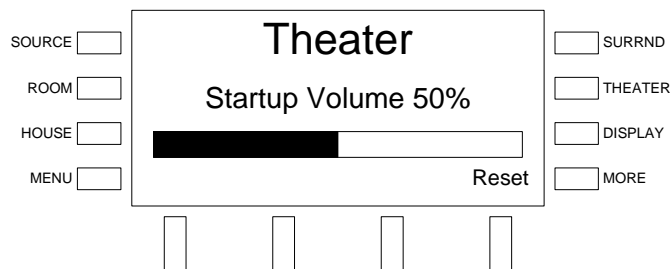
Startup Volume Control

- Adjust the startup volume with the selection knob. Turn clockwise to raise the startup volume or counterclockwise to lower the startup volume. The maximum startup volume setting is 50%. Press the soft button labeled **Reset** to set the volume level to 30%.
- Press **MENU** to return to the Theater Setup menu.

Configure Preset Groups

Preset groups can be created to group speakers in adjacent rooms with a specified source, or switch into a whole-house “party” mode, by letting the user link a source with any number of rooms. Changing the source in any one room changes the source in all of the rooms in the preset group.

Edit a Preset Group

To edit a preset group:

- Press the **ROOM** button to enter the *Room* mode.
- Press the **MORE** button.
- Press the soft button labeled **Groups** to display the list of groups.

Groups Listing

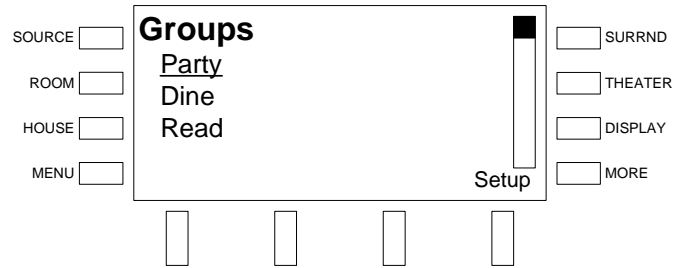

Active groups are indicated with an asterisk (*).

- Turn the selection knob to highlight the group to be configured and press the soft button labeled **Setup**. The Edit Group control will be displayed.

Edit Group Control

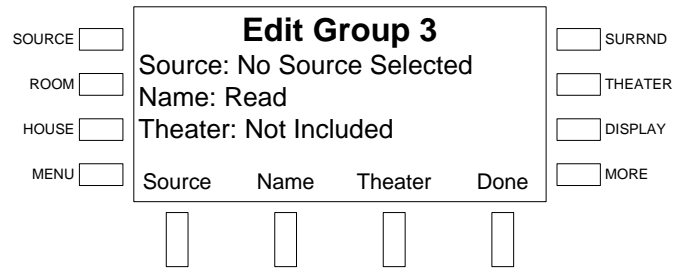

- Select the rooms in the preset group by pressing the corresponding room buttons on the AES or AAE (if connected). Each room button's LED will turn on. Press again to remove the room from the preset group. The room button's LED will turn off.
- Select a source for the preset group by pressing the soft button labeled **Source**. Turn the selection knob clockwise or counterclockwise until the desired source is displayed on the LCD and press the soft button labeled **Done**.
- Press the soft button labeled **Name** to change the name of the preset group. The group name controls will be displayed. Select letters (upper and lower-case) by turning the selection knob until the desired letter is displayed. Move the cursor to another position by pressing the soft buttons labeled **◀** and **▶**. To delete a character, press the soft button labeled **Del**.

NOTE: The maximum length for any preset group name is 16 characters.

Edit Group Name Controls

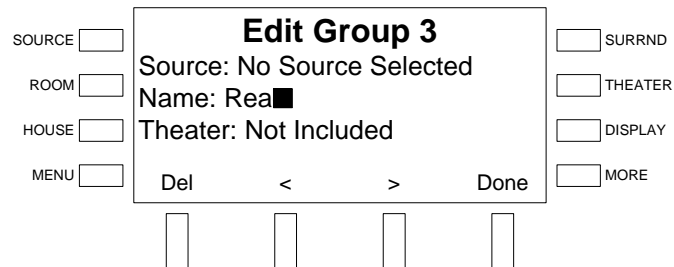

After editing the group name, press **Done** to save the name and return to the Edit Group Controls

- The theater room can be included in the group or excluded. To set the theater room's inclusion, press the soft button labeled **Theater**.
- After editing the preset group, press **Done** to save the changes and return to the Groups listing.

Operation

Prior to using this section, refer to the QuickStart Guide (Doc. 6510) that is included with the AMS.

For instructions on using the APAD and the C2N-DBF12 with the AMS refer to the latest version of the Out-Of-The-Box Functionality Guide (Doc. 6493).

Operating the AMS is broken down into seven primary functions:

Function	Page
<i>Theater Mode</i>	65
<i>Source Mode</i>	69
<i>Room Mode</i>	92
<i>Party Mode</i>	95
Locking and Unlocking the Front Panel Controls	96
Turn Off the Theater	96
Turn Off the System	96

Theater Mode

The *Theater* mode is used to view and/or listen to video and audio sources in the theater room.

Activate the Theater Mode

To activate the *Theater* mode, press any of the Theater Source buttons. Alternatively, you can press the **THEATER** button.

When in the *Theater* mode, the theater source can be selected. Adjustments to the front-panel-display backlight, *Surround Sound* mode, theater tools, groups, and sleep timer can also be made.

Select the Theater Source

There are two methods to selecting a theater source:

- Press a Theater Source button.
- Press the **THEATER** button and select a source.

Theater Mode

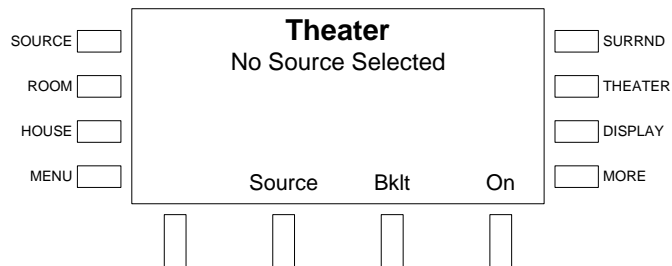

- To select a source, turn the selection knob until the desired source is displayed on the front panel and press the **ENTER** button.

Surround Sound

If a theater source receives audio from any of the analog stereo inputs, surround sound processing can be applied to the incoming audio signal. To select a *Surround Sound* mode:

- Press the **SURRND** button. The currently selected *Surround Sound* mode will be displayed.

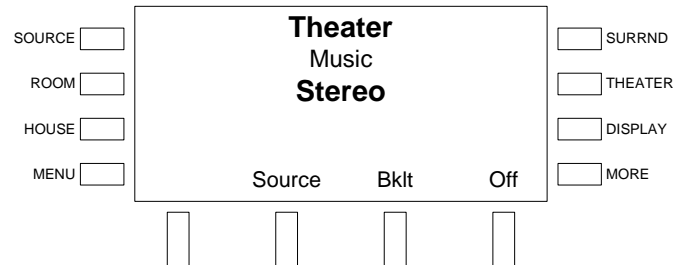
Select Surround Mode

- Turn the selection knob until the desired *Surround Sound* mode is displayed.
 - ⇒ **Automatic** – The AMS will automatically select the *Surround Sound* mode based on the selected input.
 - ⇒ **Stereo** – Sound is processed into left and right front channels.
 - ⇒ **Dolby PLII(x) Movie** – This setting is for use with VCRs, television shows, and all programs encoded in Dolby Surround. The result is an enhanced soundfield that approaches the quality of discrete 7.1-channel sound.
 - ⇒ **Dolby PLII(x) Music** – This setting is for use with any stereo music recordings, and provides a wide and deep sound space.
 - ⇒ **DTS Neo:6 Cinema** – This setting is optimum for playing movies. Decoding is performed with emphasis on separation performance to achieve the same atmosphere with 2-channel sources as with 6.1-channel sources. This setting is effective for playing sources recorded in conventional surround formats as well, because the in-phase component is assigned mainly to the center channel and the reversed phase component to the surround (left, right, and back) channels.
 - ⇒ **DTS Neo:6 Music** – This setting is suited mainly for playing music. The front (left and right) channel signals bypass the decoder and are played directly, so there is no loss of sound quality, and the effect of the surround signals output from the center and the surround (left, right, and back) channels add a natural sense of expansion to the sound field.
 - ⇒ **2 Channel Surround** – This setting is used to play stereo source material in its pure unprocessed form. The signal is steered to the surround speakers.
 - ⇒ **2-Channel-Rear** – This setting is used to play stereo source material in its pure unprocessed form. The signal is steered to the rear speakers.
 - ⇒ **Multi-Channel Stereo** – Steers the left and right audio signals to all of the theater speakers.

- ⇒ **Cathedral** – This setting recreates the sound field of a stone church.
 - ⇒ **Hall** – This setting recreates the sound field of a concert hall.
 - ⇒ **Stadium** – This setting recreates the sound field of a large open-air stadium.
 - ⇒ **Jazz Club** – This setting recreates the sound field of a concert in a club with low ceilings, hard walls, and the artist in front of the listening area.
- Press the **ENTER** button to select the displayed *Surround Sound* mode.

Adjust the Backlighting

The backlighting level of the display and buttons can be set when operating in the *Theater* mode. The display can also be set to automatically dim the display to the lowest setting after approximately 30 seconds of inactivity.

To adjust the backlighting level press the soft button labeled **Bklt** to open the Backlight controls.

Backlight Controls

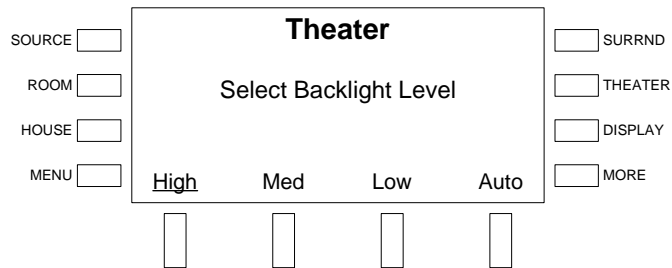

The current settings are underlined.

- Press the soft button labeled **High** to set the backlighting to the highest brightness setting.
- Press the soft button labeled **Med** to set the backlighting to the medium brightness setting.
- Press the soft button labeled **Low** to set the backlighting to the lowest brightness setting.
- To turn the automatic dimming feature on or off, press the soft button labeled **Auto**. Automatic dimming is enabled when the word **Auto** is underlined.
- Press **MENU** to return to the previous screen.

Theater Tools

Theater tools allow for the adjustment of bass and treble levels, and enabling Audyssey processing.

To open Theater tools:

- Press the **MORE** button to view additional theater controls. To return to the main theater controls, press the **MORE** button again.

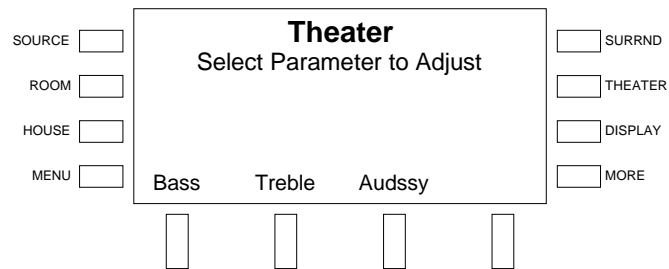
Additional Theater Controls

- Press a soft button to select the adjustment to be made. The current setting is displayed or underlined. To cancel, press **MENU**.
 - ⇒ **Bass** – Adjusts the bass level of the theater room. The bass level is adjustable from –12 dB to 12 dB.

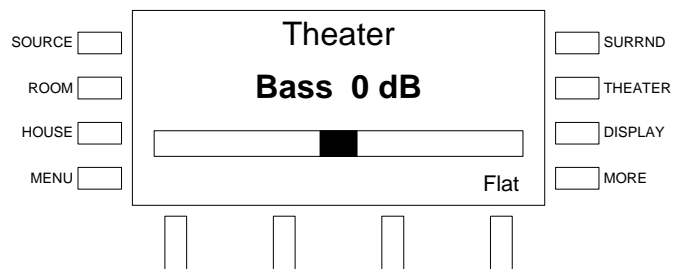
Theater Bass Control

Adjust the bass level with the selection knob and press the **ENTER** button. Turn clockwise to raise the bass level or counterclockwise to lower the bass level. Press the soft button labeled **Flat** to set the bass level to 0dB.

- ⇒ **Treble** – Adjusts the treble level of the theater room. The treble level is adjustable from –12 dB to 12 dB.

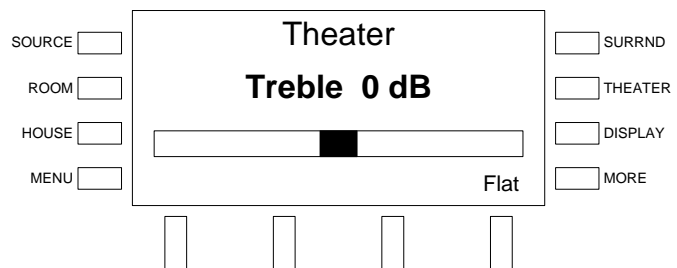
Theater Treble Control

Adjust the treble level with the selection knob and press the **ENTER** button. Turn clockwise to raise the treble level or counterclockwise to lower the treble level. Press the soft button labeled **Flat** to set the treble level to 0dB.

- ⇒ **Audssy** – Enables or disables Audyssey processing. For information on configuring Audyssey, refer to “Configuring the AMS” on page 98.

Audyssey Control

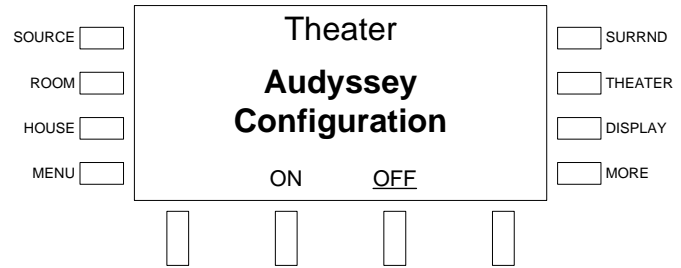

Press the soft button labeled **ON** to turn on Audyssey processing.
 Press the soft button labeled **OFF** to turn off Audyssey processing.
 Press the **MENU** button to save changes and return to the theater tools.

- Press **MENU** to save changes and return to the previous screen.

Source Mode

Source mode is used to select and control sources that are connected to the AMS. A selected source can also be routed to any room or rooms connected to the AMS or a connected AAE.

Select a Source

To select a source:

- Press **SOURCE** to put the AMS in *Source* mode. The last source selected by the selection knob is displayed on the LCD.

Source Mode

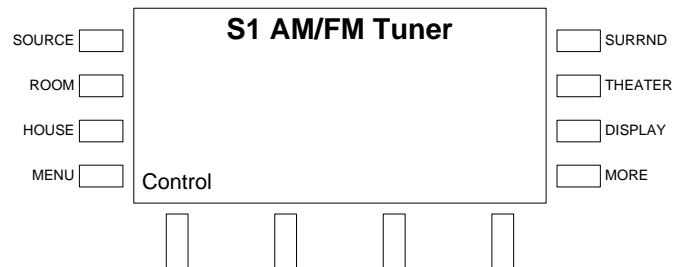

- Turn the selection knob until the desired source is displayed on the LCD. Rooms that are connected to the displayed source are indicated on the room buttons.
- Press the **ENTER** button (or the soft button labeled **Control** if it is a device that can be controlled by the AMS) to select and control the source.

When using the out-of-the-box functionality, the AMS can control tuner cards installed in slots 1 and 2, an iPod connected to a CEN-IDOC, and an AAS (when connected).

Controlling a Tuner

A tuner card installed in either slot one or two can be controlled by the AMS front panel.

The following assumes that a tuner card has been installed in slot one or two (or both) as described in the tuner card's guide.

Find the Tuner Controls

- Place the AMS in the Source mode (refer to “Select a Source” on page 69).
- Turn the selection knob to the desired tuner source (sources 1 and 2 for a tuner card installed in slot one, sources 3 and 4 for a tuner card installed in slot two). The frequency/channel and other information will be displayed.

FM Radio Source

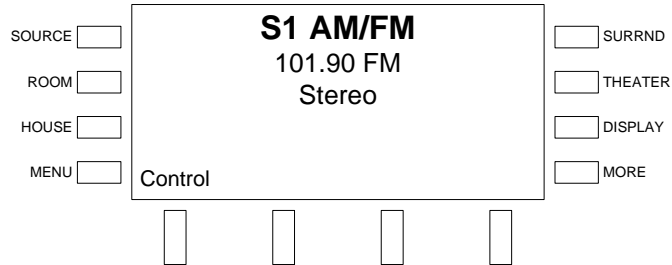

XM Radio Source

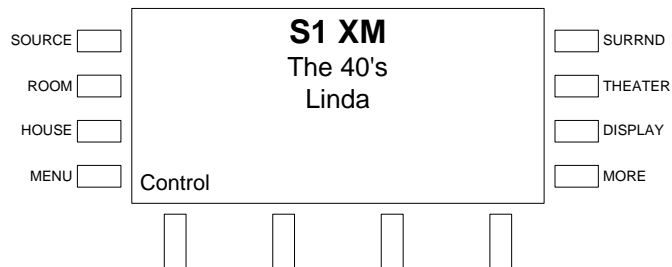

SIRIUS Radio Source

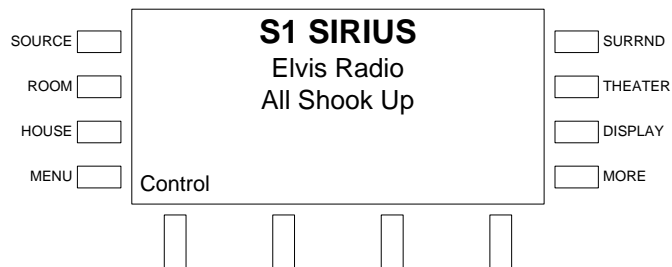

- Press the soft button labeled **Control** or press **ENTER** to open the tuner controls.

Control the AM/FM Tuner

The AM/FM tuner controls allow access to the AM/FM tuner functions. The tuner controls can recall and store presets, tune and scan stations on the frequency band, or change frequency bands (AM or FM).

AM/FM Controls

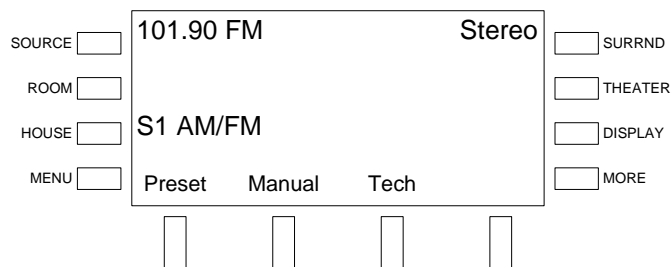

- Presets:
Use presets to recall and store favorite stations.

⇒ To recall a preset:

- ❖ Press the soft button labeled **Preset**.

Preset Controls

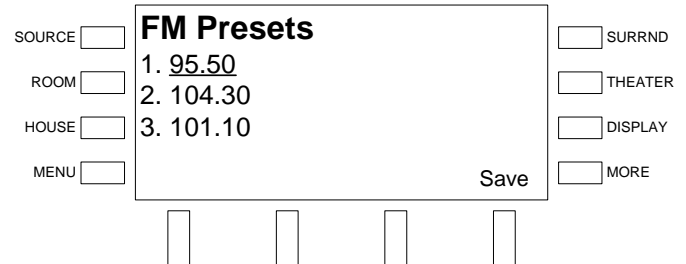

- ❖ Select a preset location with the selection knob and press the **ENTER** button.

⇒ To store a preset:

- ❖ Tune the desired station using the *Manual* tuning mode.
- ❖ Press the soft button labeled **Preset**.

Preset Controls

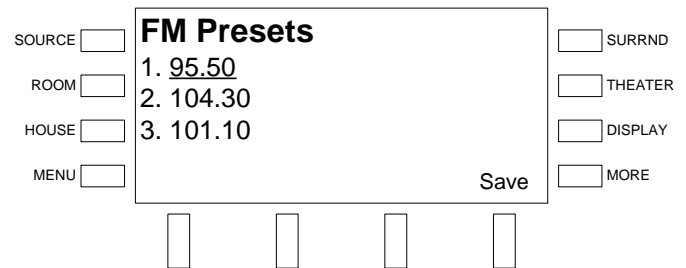

- ❖ Select a preset location with the selection knob and press the soft button labeled **Save**.

Replace Preset Prompt

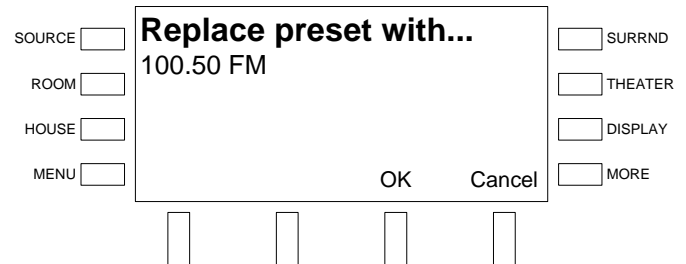

- ❖ Press the soft button labeled **OK** to confirm or the soft button labeled **Cancel** to cancel.

- *Manual Mode:*

Press the soft button labeled **Manual** to operate in the *Manual* mode.

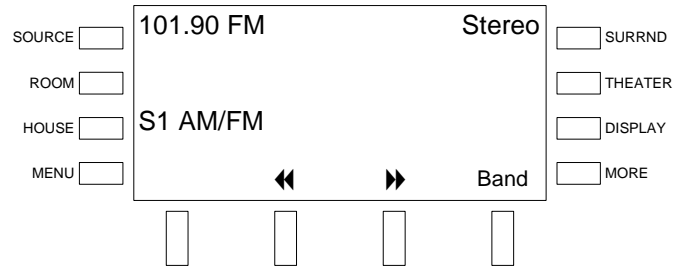
Manual Mode

When operating in *Manual* mode, the tuner can be manually tuned or it can scan each clear frequency for five seconds before seeking the next clear frequency. When in *Manual* mode, the frequency band can also be changed.

⇒ Manual Tuning:

Turn the selection knob clockwise to manually increase the frequency; or turn counterclockwise to manually decrease the frequency.

⇒ Scanning:

- ❖ Press the soft button labeled **▶▶** to start a scan that increases in frequency; or press the soft button labeled **◀◀** to start a scan that decreases in frequency to the next clear frequency.

- ❖ Stop the scan by pressing either of the scan control buttons. The scan automatically stops when the tuner reaches the frequency where the scan originally started.

⇒ Band selection:

To switch between the AM and FM frequency band, press the soft button labeled **Band**.

• Signal Strength:

To view the signal strength of the tuned frequency:

⇒ Press the soft button labeled **Tech** to view the signal strength.

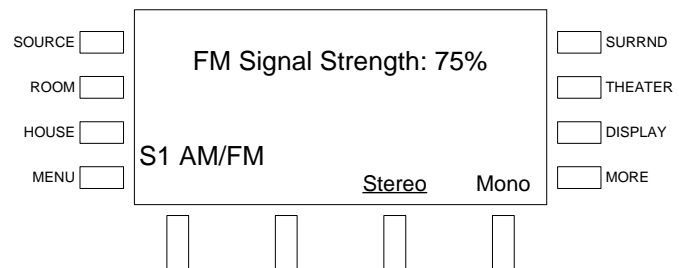
Signal Strength (FM Shown)

⇒ To return to the tuner controls, press the **MENU** button.

Control the XM Tuner

The XM tuner controls allow access to XM tuner functions such as presets, categories, and channels, as well as viewing radio signal strength.

XM Radio Controls



- Presets:
Use presets to quickly recall favorite stations.

⇒ To recall a preset:

- ❖ Press the soft button labeled **Preset**.

Preset Controls

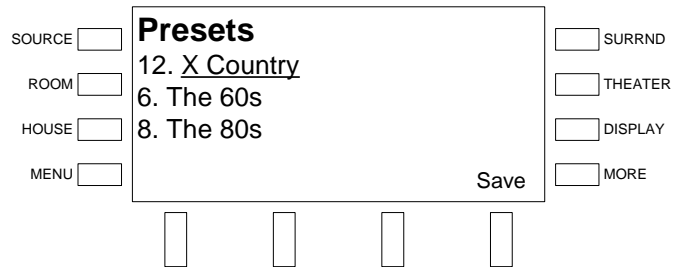

- ❖ Select a preset location with the selection knob and press the **ENTER** button.

⇒ To store a preset:

- ❖ Tune the desired station using the *Category* or *Channel* modes.
- ❖ Press the soft button labeled **Preset**.

Preset Controls

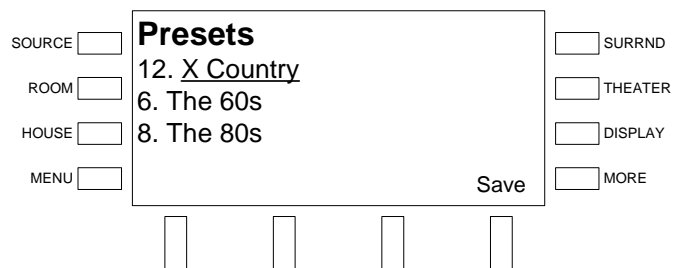

- ❖ Select a preset location with the selection knob and press the soft button labeled **Save**.

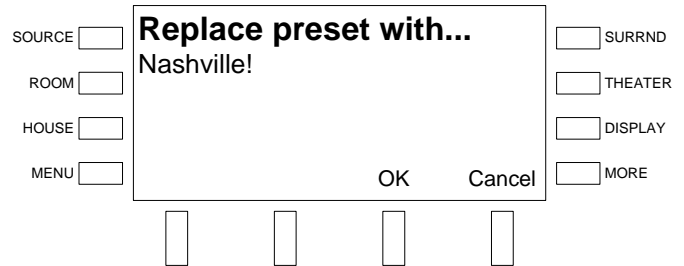
Replace Preset Prompt

- ❖ Press the soft button labeled **OK** to confirm or the soft button labeled **Cancel** to cancel.

- **Category Mode:**

The *Category* mode lets you select a channel based on a category.

- ⇒ Press the soft button labeled **Cat** to view available channel categories:

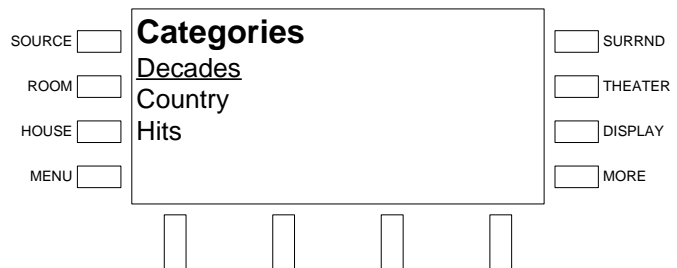
Category Controls

- ⇒ Turn the selection knob to view the list of available categories.
- ⇒ Press the **ENTER** button to select a category.
- ⇒ Turn the selection knob to view the list of channels in the category.
- ⇒ Press the **ENTER** button to select a channel.

- **Channel Mode:**

The *Channel* mode lets you select a channel based on the channel name.

- ⇒ Press the soft button labeled **Chan** to view available channels.

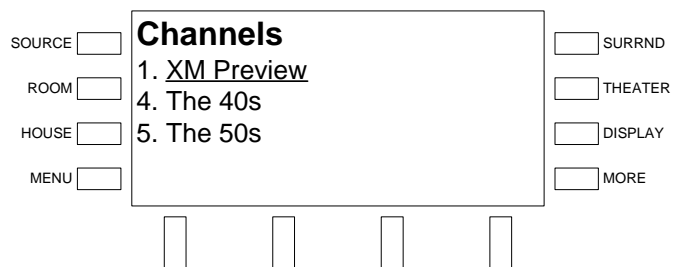
Channel Controls

- ⇒ Turn the selection knob to view the list of available channels.

NOTE: Channel 0 displays the radio ID which is required for subscription to the XM radio service.

⇒ Press the **ENTER** button to select a channel.

- **Technical Section:**

The technical section displays repeater and satellite signal strength in graphic form as well as the radio ID.

⇒ Press the soft button labeled **Tech** to view technical information about the XM receiver. The technical information section also contains controls for viewing XM tuner information and hiding channels from the displayed channel lineup.

Technical Information

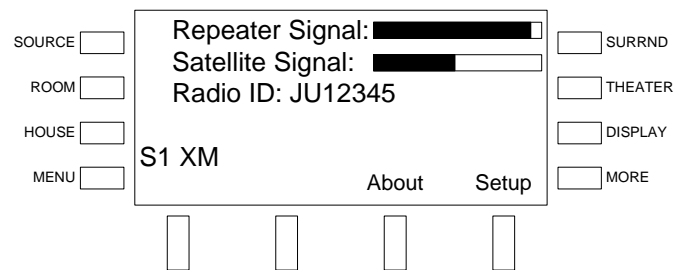

⇒ To view firmware and other information about the tuner card:

- ❖ Press the soft button labeled **About**.

About

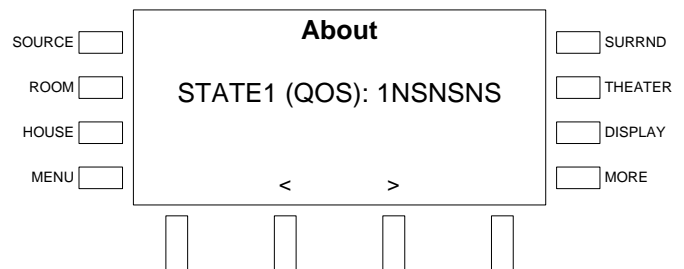

- ❖ Press the soft buttons labeled < or > to scroll through the available information.

- ❖ Press the **MENU** button to return to the XM Technical Information controls.

⇒ To hide or unhide channels from the channel listing:

- ❖ Press the soft button labeled **Setup**. The list of channels will be displayed.

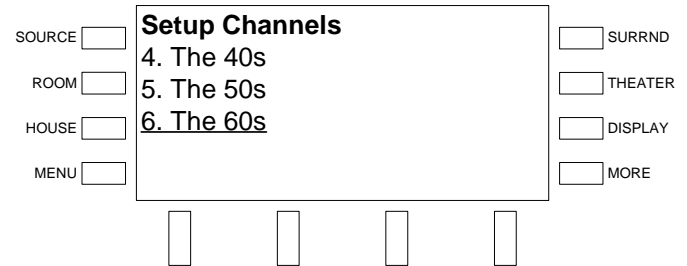
XM Channel Listing

- ❖ Turn the selection knob to highlight the channel that is to be hidden or unhidden and press the **ENTER** button to open the Hide Channel controls.

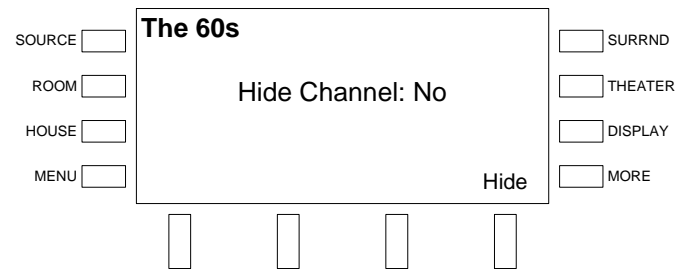
Hide Channel Controls

- ❖ The channel's status will be displayed. To change the status, press the soft button labeled **Hide**.
- ❖ Press the **MENU** button to return to the XM Technical Information controls.

⇒ Press the **MENU** button to return to the XM Radio controls.

Control the SIRIUS Tuner

The SIRIUS tuner controls allow access to SIRIUS tuner functions such as presets, categories, and channels, as well as viewing radio signal strength.

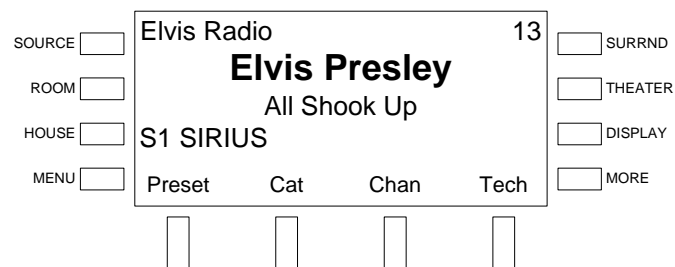
SIRIUS Radio Controls

- Presets:

Use presets to quickly recall favorite stations.

⇒ To recall a preset, press the soft button labeled **Preset**.

Preset Controls

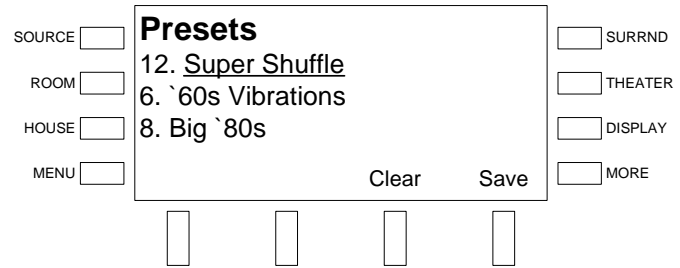

⇒ Select a preset location with the selection knob and press the **ENTER** button. If the channel is locked, you will be prompted to enter a Personal Identification Number (PIN).

Enter PIN

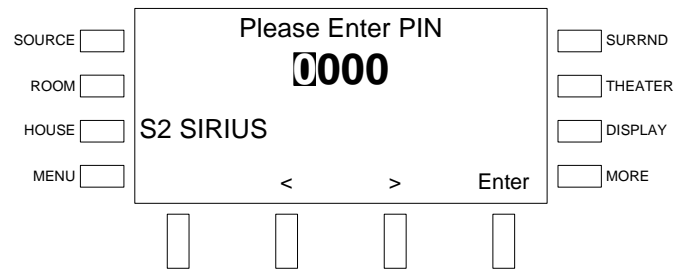

- ❖ Enter the first digit of the PIN (the factory default is 1234) by turning the selection knob clockwise or counterclockwise until the desired digit is displayed.
- ❖ Press the soft buttons labeled < or > to move the cursor to the previous or next digit and enter the rest of the PIN.
- ❖ When the PIN is displayed, press the soft button labeled **ENTER** to unlock the channel.

⇒ To store a preset:

- ❖ Tune the desired station using the *Category* or *Channel* modes.
- ❖ Press the soft button labeled **Preset**.

Preset Controls

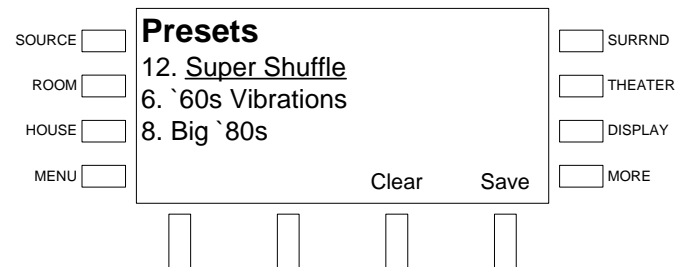

- ❖ Select a preset location with the selection knob and press the soft button labeled **Save**.

Replace Preset Prompt

- ❖ Press the soft button labeled **OK** to confirm or the soft button labeled **Cancel** to cancel.

⇒ To clear a preset location:

- ❖ Select a preset with the selection knob and press the soft button labeled **Clear**.

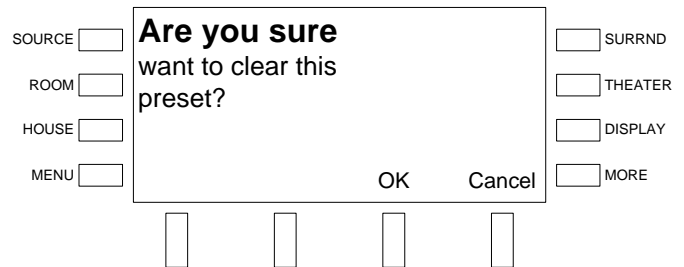
Clear Preset

- ❖ Press the soft button labeled **OK** to clear the preset location or press the soft button labeled **Cancel** to cancel.

- **Category Mode:**

The *Category* mode lets you select a channel based on a category.

⇒ Press the soft button labeled **Cat** to view available channel categories:

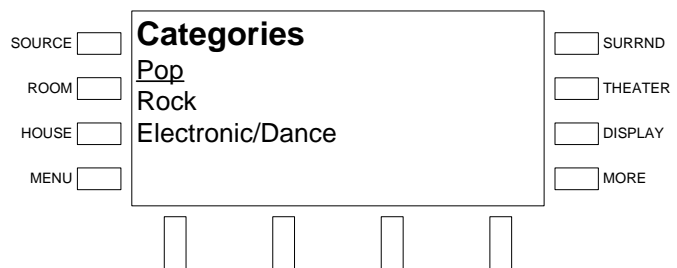
Category Controls

- ⇒ Turn the selection knob to view the list of available categories.
- ⇒ Press the **ENTER** button to select a category.
- ⇒ Turn the selection knob to view the list of channels in the category.

NOTE: Some channels may be locked or hidden from view. To select which channels are locked or hidden from view, refer to “Technical Section” on page 80.

⇒ Press the **ENTER** button to select a channel. If the channel is locked, you will be prompted to enter a Personal Identification Number (PIN).

Enter PIN

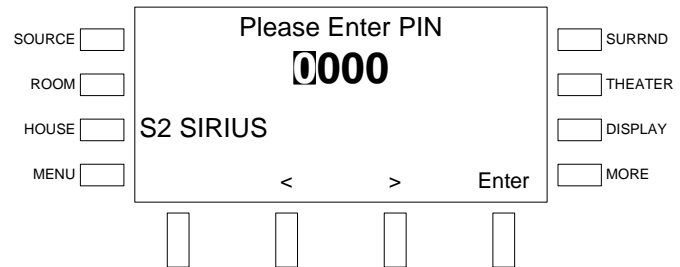

- ❖ Enter the first digit of the PIN (the factory default is 1234) by turning the selection knob clockwise or counterclockwise until the desired digit is displayed.
- ❖ Press the soft buttons labeled < or > to move the cursor to the previous or next digit and enter the rest of the PIN.
- ❖ When the PIN is displayed, press the soft button labeled **ENTER** to unlock the channel.

- **Channel Mode:**

The *Channel* mode lets you select a channel based on the channel name.

⇒ Press the soft button labeled **Chan** to view available channels.

Channel Controls

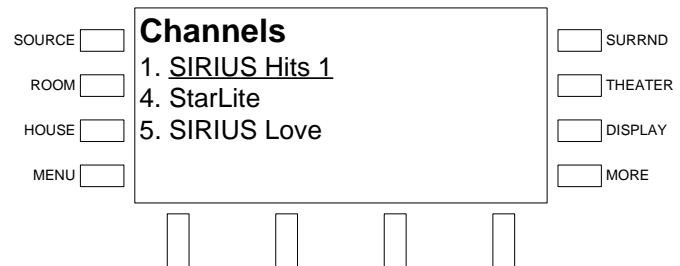

⇒ Turn the selection knob to view the list of available channels.

NOTE: Some channels may be locked or hidden from view. To select which channels are locked or hidden from view, refer to “Technical Section” on page 80.

NOTE: Channel 0 displays the radio ID which is required for subscription to the SIRIUS radio service.

- ⇒ Press the **ENTER** button to select a channel. If the channel is locked, you will be prompted to enter a Personal Identification Number (PIN).

Enter PIN

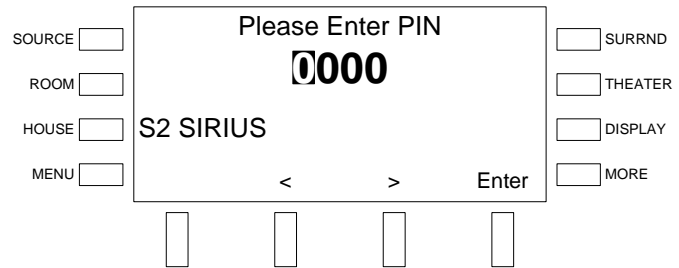

- ❖ Enter the first digit of the PIN (the factory default is 1234) by turning the selection knob clockwise or counterclockwise until the desired digit is displayed.
 - ❖ Press the soft buttons labeled < or > to move the cursor to the previous or next digit and enter the rest of the PIN.
 - ❖ When the PIN is displayed, press the soft button labeled **ENTER** to unlock the channel.
- **Technical Section:**
The technical section displays repeater and satellite signal strength in graphic form as well as the radio ID. The technical information section also contains controls for viewing SIRIUS tuner information, locking channels (accessible by entering a Personal Identification Number), hiding/exposing channels from the channel list (accessible by entering a Personal Identification Number), and resetting the Personal Identification Number (PIN).

- ⇒ Press the soft button labeled **Tech** to view information about the repeater signal strength, satellite signal strength, and the radio ID. Buttons for viewing tuner card information and tuner setup will also be displayed.

Technical Information

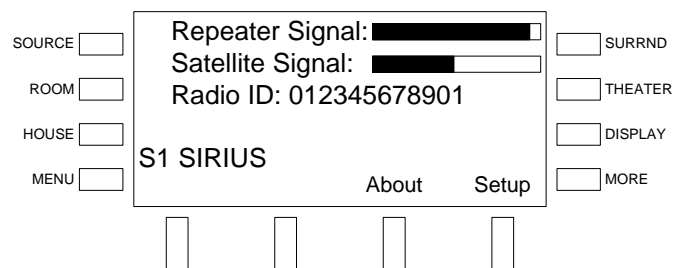

- ⇒ To view firmware and other information about the tuner card:
- ❖ Press the soft button labeled **About**.

About

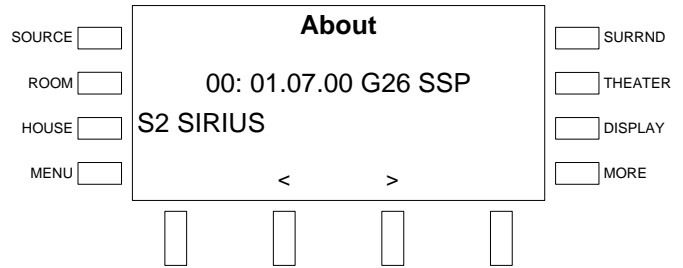

- ❖ Press the soft buttons labeled < or > to scroll through the available information.
- ❖ Press the **MENU** button to return to the SIRIUS Technical Information controls.

⇒ To hide or unhide channels from the channel listing:

- ❖ Press the soft button labeled **Setup**. A prompt to enter a Personal Identification Number (PIN) will be displayed.

Enter PIN

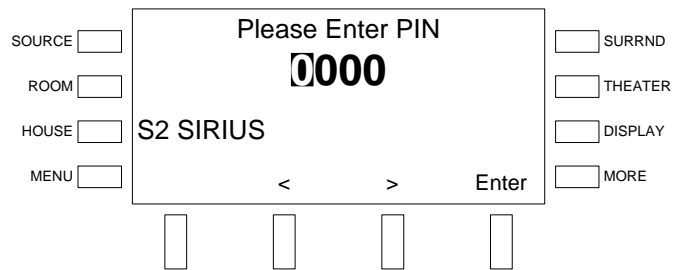

- ❖ Enter the first digit of the PIN (the factory default is 1234) by turning the selection knob clockwise or counterclockwise until the desired digit is displayed.
- ❖ Press the soft buttons labeled < or > to move the cursor to the previous or next digit and enter the rest of the PIN.
- ❖ When the PIN is displayed, press the soft button labeled **ENTER** to open the Setup controls.

Setup Controls

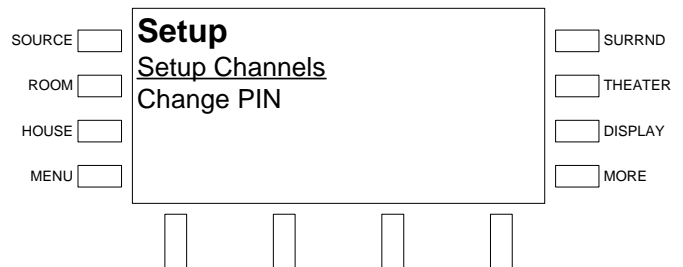

- ❖ Turn the selection knob clockwise or counterclockwise to highlight **Setup Channels** and press the **ENTER** button to display a list of all of the SIRIUS channels.

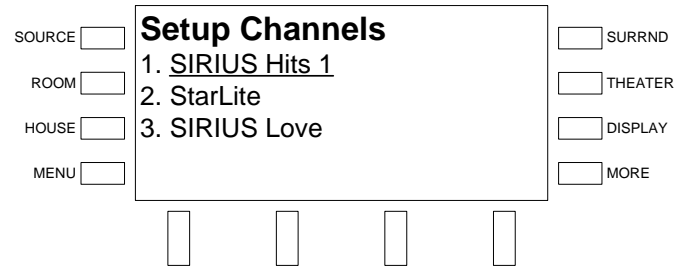
Setup Controls—Channel Listing

- ❖ Turn the selection knob to highlight the channel that is to be hidden or unhidden and press the **ENTER** button to open the Lock/Hide Channel controls.

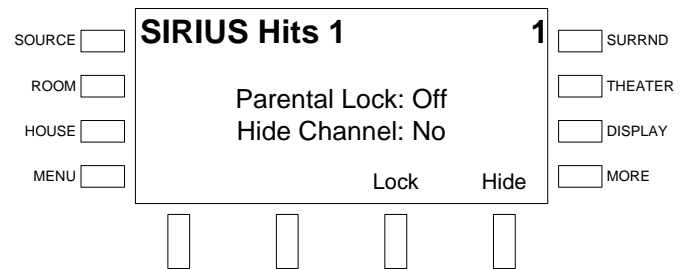
Lock/Hide Channel Controls

- ❖ If a channel is to be hidden, press the soft button labeled **Hide**. If a hidden channel is to be unhidden, press the soft button labeled **Hide**.
- ❖ Press the **MENU** button to return to the SIRIUS Technical Information controls.

⇒ To lock or unlock channels:

- ❖ Press the soft button labeled **Setup**. A prompt to enter a Personal Identification Number (PIN) will be displayed. Enter the PIN as described on page 80 to open the Setup controls.

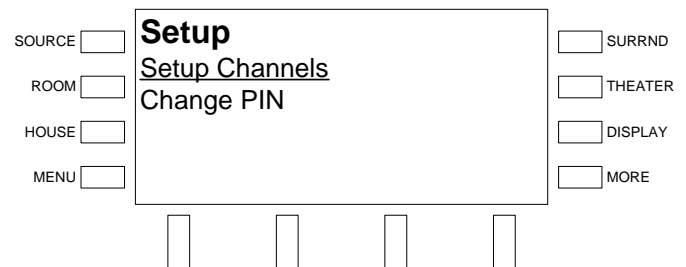
Setup Controls

- ❖ Turn the selection knob clockwise or counterclockwise to highlight **Setup Channels** and press the **ENTER** button to display a list of all of the SIRIUS channels.

Setup Controls—Channel Listing

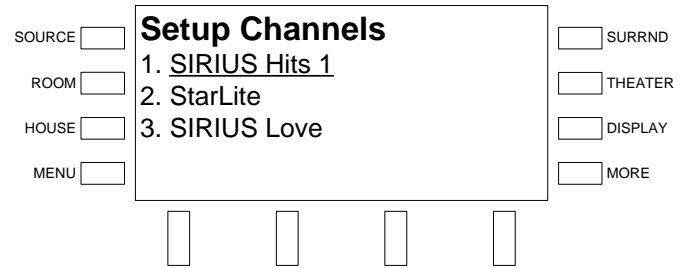

- ❖ Turn the selection knob to highlight the channel that is to be hidden or unhidden and press the **ENTER** button to open the Lock/Hide channel controls.

Lock/Hide Channel Controls

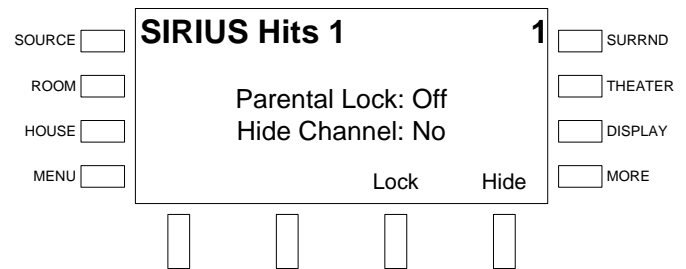

- ❖ If a channel is to be locked, press the soft button labeled **Lock**. If a hidden channel is to be unlocked, press the soft button labeled **Lock**.
- ❖ Press the **MENU** button to return to the SIRIUS Technical Information controls.

⇒ To change the Personal Identification Number (PIN):

- ❖ Press the soft button labeled **Setup**. A prompt to enter a Personal Identification Number (PIN) will be displayed. Enter the PIN as described on page 80 to open the Setup controls.

Setup Controls

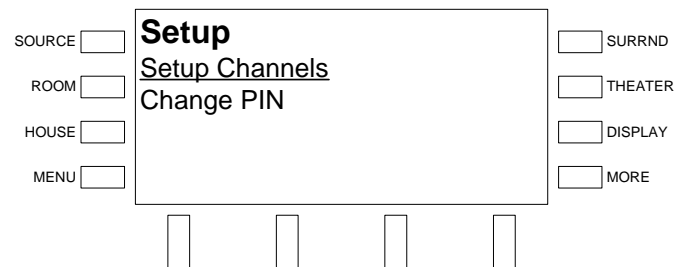

- ❖ Turn the selection knob clockwise or counterclockwise to highlight **Change PIN** and press the **ENTER** button to display the Change PIN controls.

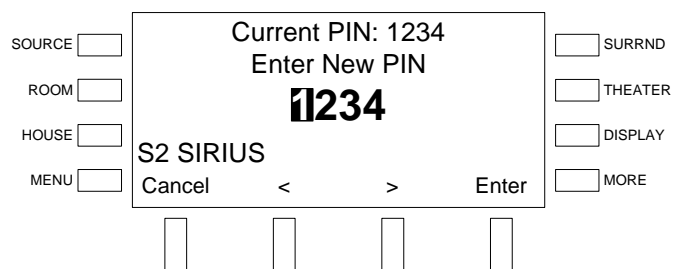
Change PIN Controls

- ❖ Enter the first digit of the PIN by turning the selection knob clockwise or counterclockwise until the desired digit is displayed.
 - ❖ Press the soft buttons labeled < or > to move the cursor to the previous or next digit and enter the rest of the PIN.
 - ❖ When the new PIN is displayed, press the soft button labeled **ENTER** to open the Setup controls. To cancel, press the soft button labeled **Cancel**.
- ⇒ To reset the Personal Identification Number (PIN) to the factory default (1234):
- ❖ Press and hold the left-most and right-most soft buttons. After approximately three seconds, the display will indicate that the PIN has been reset to the factory default.
 - ❖ Press the soft button labeled **OK**.
- ⇒ Press the **MENU** button to return to the SIRIUS Radio controls.

Controlling an iPod or iPhone

An Apple iPod or iPhone can be controlled from the AMS front panel with an optional CEN-IDOC Interface for Apple iPod®.

NOTE: All references to Apple iPod include the Apple iPhone.

The following assumes that the CEN-IDOC has been installed and an iPod has been connected as described in the CEN-IDOC guide.

Find the iPod Controls

- Place the AMS in the *Source* mode (refer to “Select a Source” on page 69).
- Turn the selection knob to the iPod source (source #5). The playback status, current track, and artist playing on the iPod will be displayed.

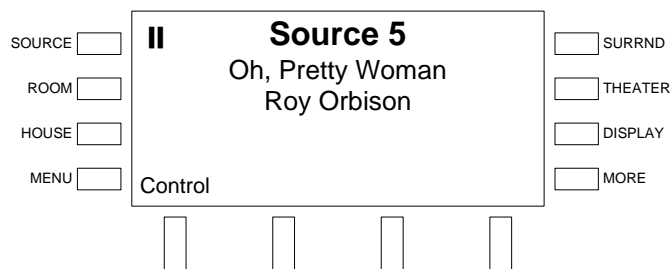
iPod Source

Play iPod Songs with the AMS

- Press the soft button labeled **Control** to open the iPod controls.

Use the AMS front panel to control playback of songs on the iPod.

iPod Playback Controls

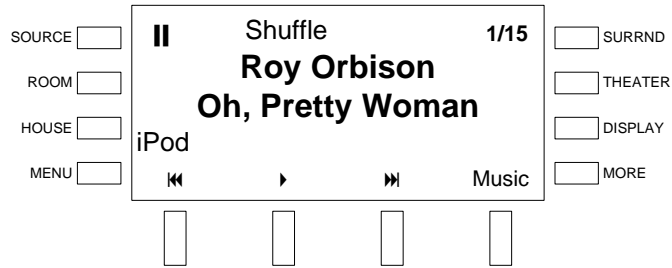

- Press the soft button labeled **⏮** to return to the beginning of the current song or skip to the previous song. If the iPod is paused, press the soft button labeled **▶** to resume playback. If the iPod is currently playing, press the soft button labeled **⏸** to pause playback. Press the soft button labeled **⏭** to skip to the next song. Press the soft button labeled **Music** to open the iPod song menu (for details, refer to “Select Songs with the AMS” on page 86). Press the **DISPLAY** button to toggle between the artist name and the album name. Press the **MORE** button to display soft buttons to change the *Shuffle* and *Repeat* modes. Press the **MORE** button again to return to the playback controls.

iPod Playback Controls, Page 2



- **Shuffle** – Press the soft button labeled **Shuffle** to open the Shuffle control.

Shuffle Control

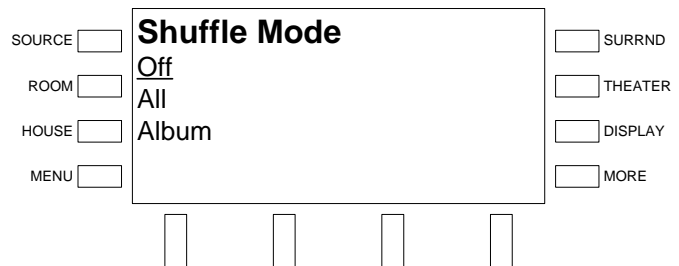

⇒ Turn the selection knob to the desired *Shuffle* mode.

- ❖ **Off** – Plays all items in sequence.
- ❖ **All** – Will shuffle all items in the list.
- ❖ **Album** – Will play the songs on an album in order and then shuffle the order of the albums.

⇒ Press the **ENTER** button to select the highlighted mode.

- **Repeat** – Press the soft button labeled **Repeat** to open the Repeat control.

Repeat Control

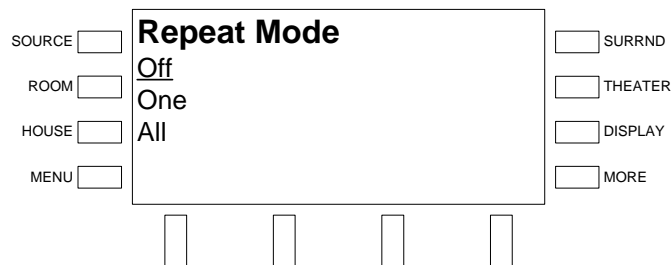

⇒ Turn the selection knob to the desired *Repeat* mode.

- ❖ **Off** – Plays all items in sequence.
- ❖ **One** – Will repeat the current song.
- ❖ **All** – Will repeat all of the songs when they are done playing.

⇒ Press the **ENTER** button to select the highlighted mode.

Select Songs with the AMS

The AMS front panel can be used to select a specific playlist, artist, album, or song on an iPod.

- Press the soft button labeled **Music** to open the iPod Music menu.

Music Menu

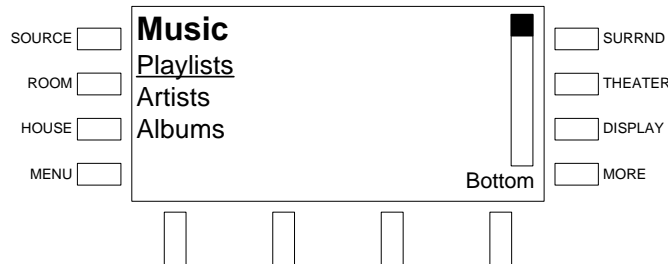

- Turn the selection knob to highlight an item (**Playlists**, **Artists**, **Albums**, etc.) and press the **ENTER** button. The scroll bar indicates the position of the cursor on the displayed list. To jump to the first item in the list, turn the selection knob counterclockwise and press the soft button labeled **Top**. To jump to the last item in the list, turn the selection knob clockwise and press the soft button labeled **Bottom**. If a song name is selected, pressing the **ENTER** button will begin playback.

Playlist Items



- When viewing a list of songs, press the **ENTER** button to play the selected song. To jump to the first item in the list, turn the selection knob counterclockwise and press the soft button labeled **Top**. To jump to the last item in the list, turn the selection knob clockwise and press the soft button labeled **Bottom**. To return to the previous topic (playlist, album, etc.) press the soft button labeled **Back**.

Controlling an Adagio Audio Server (AAS)

An AAS can be controlled from the AMS front panel.

The following assumes that the AAS has been installed and connected as described in the AAS guide.

Find the AAS Controls

- Place the AMS in the *Source* mode (refer to “Select a Source” on page 69).
- Turn the selection knob to an AAS source (source 7 for an AAS-1, sources 7 or 8 for an AAS-2, or sources 7, 8, 9, or 10 for an AAS-4 if using out-of-the-box functionality). The playback status, current track, and artist playing on the AAS source will be displayed.

AAS Source

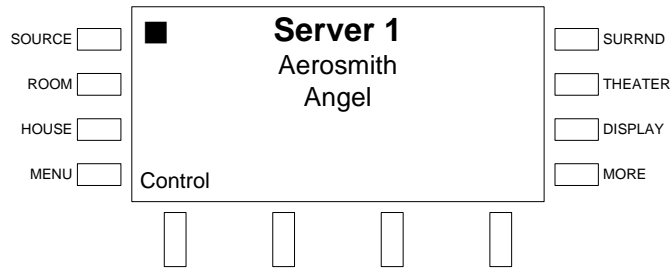

- Press the soft button labeled **Control** to open the AAS controls.

Play AAS Songs with the AMS

Use the AMS front panel to control playback of songs on the AAS.

AAS Playback Controls

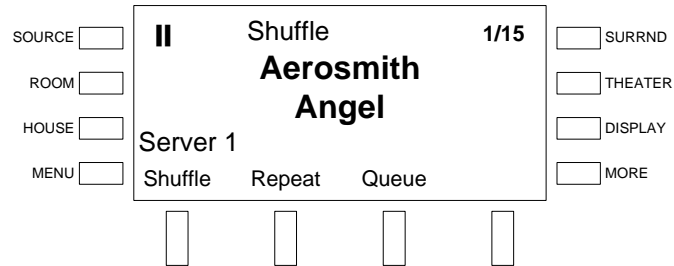

- Press the soft button labeled **⏮** to return to the beginning of the current song or skip to the previous song. If the AAS is paused, press the soft button labeled **▶** to resume playback. If the AAS is currently playing, press the soft button labeled **⏸** to pause playback. Press the soft button labeled **⏭** to skip to the next song. Press the soft button labeled **Music** to open the AAS song menu (for details, refer to “Browse the AAS Library with the AMS” on page 90). Press the **DISPLAY** button to toggle between the artist name and the album name. Press the **MORE** button to display soft buttons to change the *Shuffle* and *Repeat* modes and manage the playback queue. Press the **MORE** button again to return to the playback controls.

AAS Playback Controls, Page 2

- **Shuffle** – The *Shuffle* mode of each of the AAS’ outputs can be controlled independently. Press the soft button labeled **Shuffle** to open the Shuffle control.

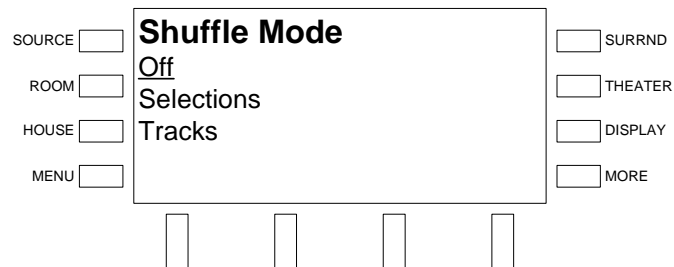
Shuffle Control

⇒ Turn the selection knob to the desired *Shuffle* mode.

- ❖ **Off** – Plays all queued items in sequence.
- ❖ **Selections** – Will randomize all items in the play queue. Group items such as playlists will be played in order. However, the order of group items will be shuffled.
- ❖ **Tracks** – Will shuffle all of the tracks in the play queue.

⇒ Press the **ENTER** button to select the highlighted mode.

- **Repeat** – The *Repeat* mode of each of the AAS’ outputs can be controlled independently. Press the soft button labeled **Repeat** to open the Repeat control.

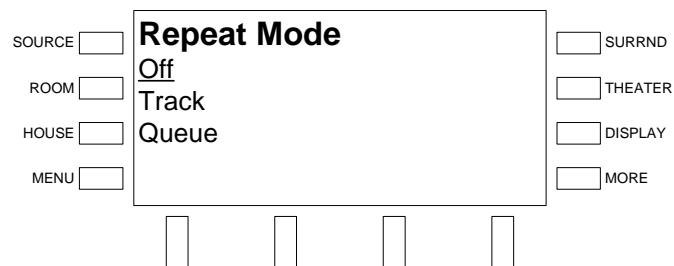
Repeat Control

⇒ Turn the selection knob to the desired *Repeat* mode.

- ❖ **Off** – Plays all queued items once without repeat.
- ❖ **Track** – Will repeat the track that is currently playing.
- ❖ **Queue** – Will repeat all of the tracks in the play queue.

⇒ Press the **ENTER** button to select the highlighted mode.

- **Queue** – The AMS front panel can be used to browse the play queue, save a play queue as a playlist on the AAS, clear a play queue, or manage the play queue. Press the soft button labeled **Queue** to open the Queue control.

Queue Control

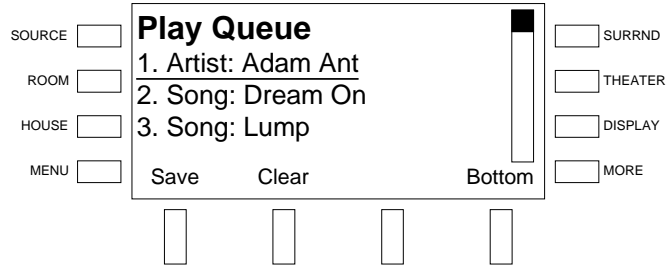

⇒ To browse the songs on a play queue, turn the selection knob clockwise or counterclockwise. To jump to the bottom of the play queue, press the soft button labeled **Bottom**. To jump to the top of the play queue, press the soft button labeled **Top** (replaces **Bottom** when at the bottom of a list).

⇒ To save the play queue as a playlist that can be recalled, press the soft button labeled **Save** which will open the Name Playlist control.

Name Playlist Control



- ❖ Turn the selection knob to the desired letter and press the **ENTER** button to insert the letter in the playlist name.
- ❖ Press the soft button labeled **Back** to erase the previous character and move the cursor back one space.
- ❖ To save the playlist name, press the soft button labeled **Enter**.

⇒ To clear the play queue, press the soft button labeled **Clear**.

Clear Play Queue Confirmation

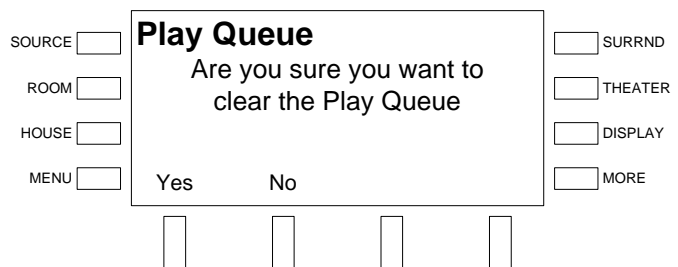

- ❖ To confirm the operation, press the soft button labeled **Yes**.
 - ❖ To cancel the operation, press the soft button labeled **No**.
- ⇒ To manage an item in the play queue, turn the selection knob to highlight an item in the queue and press the **ENTER** button to open the Play Queue Management control.

Play Queue Management Control

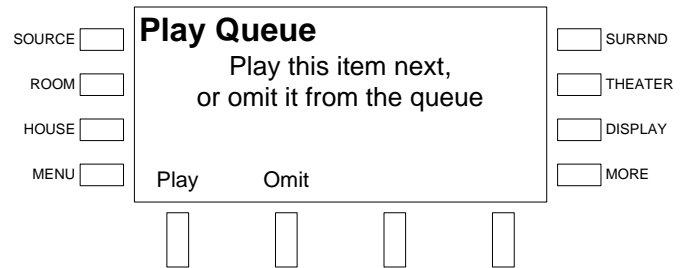

- ❖ To move the item to the top of the queue, press the soft button labeled **Play**.
- ❖ To remove the item from the queue, press the soft button labeled **Omit**.

⇒ Press the **MENU** button to return to the playback controls.

Browse the AAS Library with the AMS

The AMS front panel can be used to select a category (playlist, artist, album, era, etc.) or song in the AAS library. Categories and individual tracks can either be played or added to the play queue.

- Press the soft button labeled **Music** to open the Browse menu.

Browse Menu

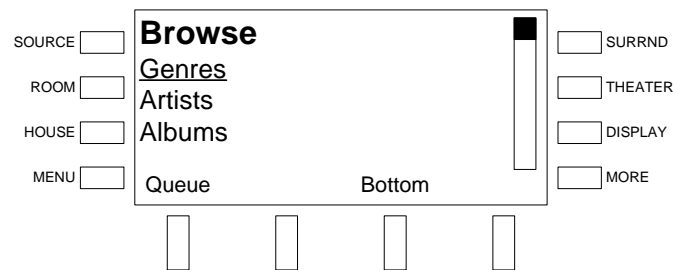

- Turn the selection knob clockwise or counterclockwise to browse the selections. To jump to the bottom of the list, press the soft button labeled **Bottom**. To jump to the top of the list, press the soft button labeled **Top** (replaces **Bottom** when at the bottom of a list).

To select an item (**Genre, Artists, Albums**, etc.), turn the selection knob to highlight the item and press the **ENTER** button.

Press the soft button labeled **Queue** to view items in the play queue. For more information on the play queue, refer to “Queue” on page 89.

For more information on the library structure, refer to the latest version of the AAS guide.

Song List

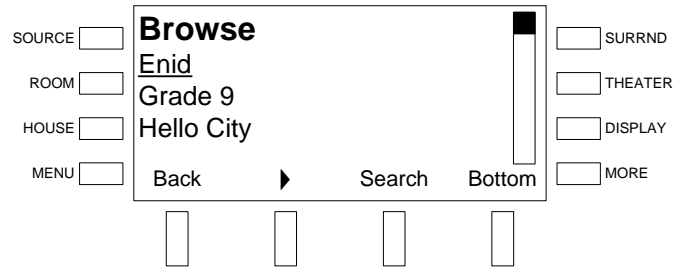

⇒ To go back a level, press the soft button labeled **Back**.

⇒ To play a song, category, artist, or album, highlight the item with the selection knob and press the soft button labeled **▶**.

If a group (**Genre** or **All Songs**) or an individual song is highlighted, press the **ENTER** button to choose between playing the highlighted selection (thereby replacing the queue) or adding the selected item to the current queue.

Play Now or Add to List

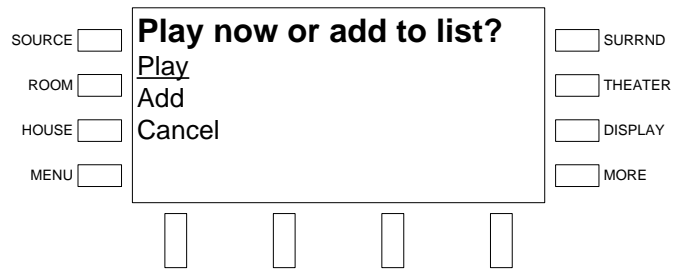

❖ To play the song or collection and delete the current play queue, use the selection knob to highlight **Play** and press the **ENTER** button.

❖ To add the song or collection to the play queue, use the selection knob to highlight **Add** and press the **ENTER** button.

❖ To cancel, use the selection knob to highlight **Cancel** and press the **ENTER** button.

⇒ Press the soft button labeled **Search** to jump to an item in a list. Refer to “Search the AAS Library with the AMS” below for more information.

⇒ To jump to the bottom of the list, press the soft button labeled **Bottom**. To jump to the top of the list, press the soft button labeled **Top** (replaces **Bottom** when at the bottom of a list).

- Press the soft button labeled **Search** to jump to an item in a list.

Search the AAS Library with the AMS

NOTE: Searches are performed within a category. For example, searching for a song title while browsing artists will not yield any results.

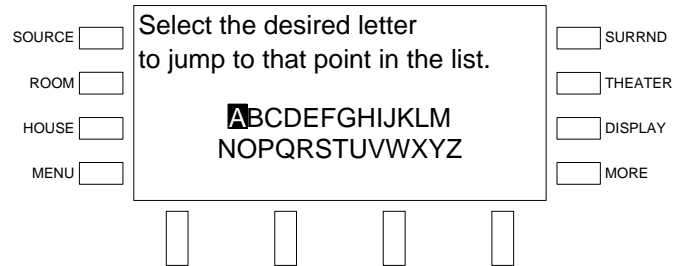
Search

⇒ Select a letter with the selection knob and press the **ENTER** button.

Route a Source

Rooms that are connected to the source are indicated on the room buttons.

- Select a source as described on page 69.
- Press room buttons on the AMS or AAE to route the selected source to a room.

NOTE: Volume adjustment is not available when the AMS is in *Source* mode. When a source is routed to a room that is not already on, the room will be turned on at the startup volume specified on page 60.

Room Mode

Room mode is used to select and control a room that is connected to the AMS. If a room button LED is on, then the room is connected to an audio source. If a room button LED is off, then the room is turned off.

Select a Room

To select a room:

- Press **Room** to put the AMS in the *Room* mode. The current selected room is displayed on the LCD.

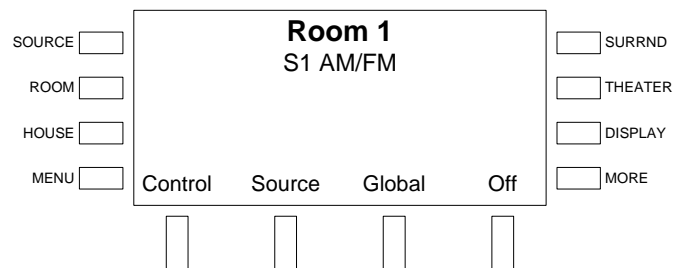
Room Mode

- Turn the selection knob until the desired room is displayed on the LCD. Alternatively, press a room button on the AMS or AAE (if connected).

Control a Room

After a room is selected, a source can be selected, the room can be turned “off”, room and global volume can be adjusted, or the room output can be muted.

- To select a source:
 - ⇒ Press the soft button labeled **Source**.

- ⇒ Turn the selection knob until the desired source is displayed on the LCD and press the **ENTER** button to select the source.
- ⇒ To control the source, press the soft button labeled **Control** (if available).
- ⇒ To view options for adjusting audio parameters (bass, treble, balance, and loudness), press the **MORE** button.
- To turn on the room, press the soft button labeled **On**.
- To turn off the room, press the soft button labeled **Off**.
- To adjust the room's volume, turn the volume knob. The volume level will be displayed on the LCD.
- To adjust the volume in all of the rooms that are on:
 - ⇒ Press the soft button labeled **Global**.

Global Volume

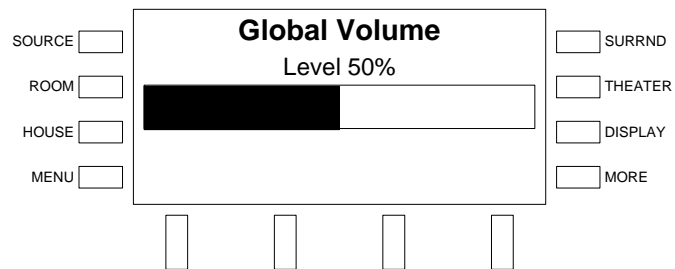

- ⇒ Turn the volume knob to adjust the global volume level. The global volume level will be displayed on the LCD.

The global volume adjusts the volume in every room that is currently turned on. The volumes are adjusted proportionately so the room volume levels do not jump to the same level when the global volume control is used.

- ⇒ Press **MENU** to return to the room menu.
- To mute the room output, press the **MUTE** button (the **MUTE** LED will light). To unmute the room, press the **MUTE** button again.

Adjust the Bass

The bass level of each room can be adjusted independently.

- While in *Room* mode, press the **MORE** button.
- Press the soft button labeled **Tools**.
- Press the soft button labeled **Bass** to open the Bass control.

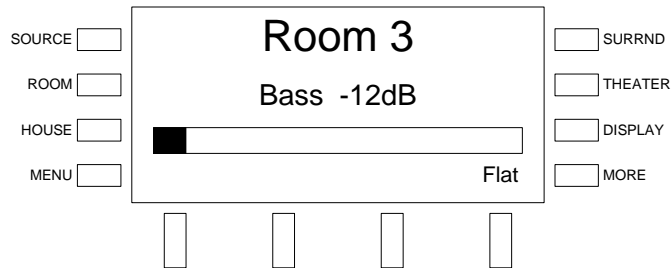
Bass Control

- Adjust the bass level with the selection knob. Turn clockwise to raise the bass level or counterclockwise to lower the bass level. Press the soft button labeled **Flat** to set the bass level to 0dB.

NOTE: Other rooms can be adjusted by pressing a different room button.

- Press **MENU** to save changes and return to the previous screen.

Adjust the Treble

The treble levels of each room can be adjusted independently.

- While in *Room* mode, press the **MORE** button.
- Press the soft button labeled **Tools**.
- Press the soft button labeled **Treble** to open the Treble control.

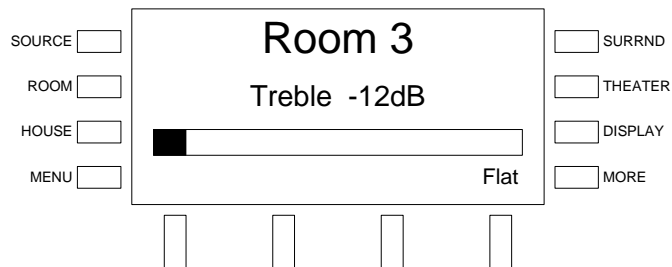
Treble Control

- Adjust the treble level with the selection knob. Turn clockwise to raise the treble level or counterclockwise to lower the treble level. Press the soft button labeled **Flat** to set the treble level to 0dB.

NOTE: Other rooms can be adjusted by pressing a different room button.

- Press the **MENU** button to save changes and return to the previous screen.

Adjust the Balance

The balance of each room can be adjusted independently.

- While in *Room* mode, press the **MORE** button.
- Press the soft button labeled **Tools**.
- Press the soft button labeled **Balance** to open the Balance control.

Balance Control

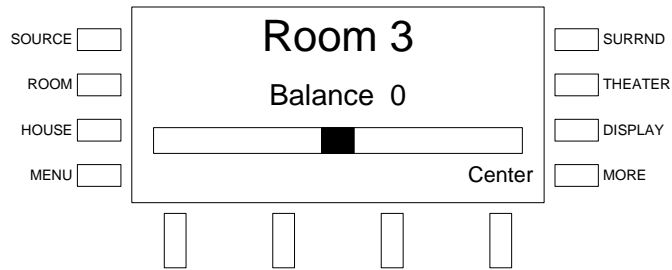

- Adjust the balance with the selection knob. Turn clockwise to set the balance to the right or counterclockwise to set the balance to the left. Press the soft button labeled **Center** to center the balance.

NOTE: Other rooms can be adjusted by pressing a different room button.

- Press **MENU** to save changes and return to the previous screen.

Set Loudness

The loudness settings of each room can be adjusted independently.

- While in *Room* mode, press the **MORE** button.
- Press the soft button labeled **Tools**.
- Press the soft button labeled **Loud** to open the Loudness control.

Loudness Control

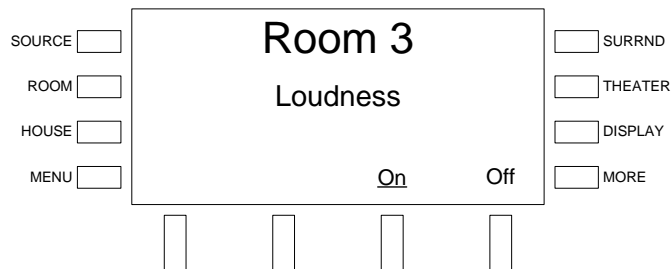

- The current setting is underlined. To turn loudness on, press the soft button labeled **On**. To turn loudness off, press the soft button labeled **Off**.

NOTE: Other rooms can be adjusted by pressing a different room button.

- Press **MENU** to save changes and return to the previous screen.

Party Mode and Other Room Groups

Party mode and other room groups are preset settings used to recall source/room combinations.

Activate the Party Mode

Press the **PARTY MODE** button to activate the *Party* mode.

For instructions on customizing the *Party* mode, refer to “Configure Preset Groups” on page 62.

Recall a Room Group

To recall a room group:

- While in *Room* mode, press the **MORE** button.

- Press the soft button labeled **Groups** to display the list of groups.

Groups Listing

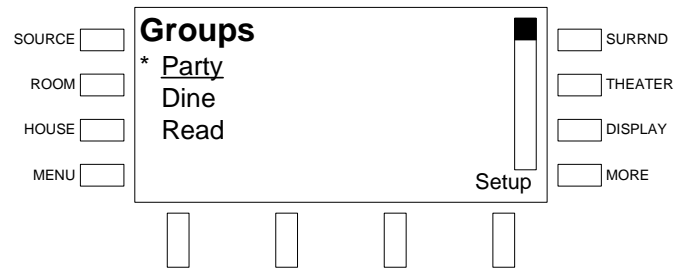

Active groups are indicated with an asterisk (*).

- Turn the selection knob to highlight the desired group and press **ENTER**.

For instructions on customizing a group, refer to “Configure Preset Groups” on page 62.

Lock and Unlock the Front Panel Controls

The front panel controls can be locked by pressing the **MENU** and **DISPLAY** buttons simultaneously for five seconds.

The front panel controls can be unlocked by pressing the **MENU** and **DISPLAY** buttons simultaneously for five seconds.

Turn off the Theater

Press **THEATER OFF** to turn off the theater outputs. The room outputs will stay on.

Turn off the System

Press **All Off** to turn off all of the rooms and the theater.

Programming Software

Refer to this section only if a custom program for the AMS is to be created.

A built-in program containing the out-of-the-box functionality resides in a protected area of the AMS' flash memory. The program cannot be erased and can be recalled at any time by holding the software reset button during a hardware reset.

The built-in-program cannot be modified using the tools described in this section.

Have a question or comment about Crestron software?

Answers to frequently asked questions (FAQs) can be viewed in the Online Help section of the Crestron website. To post a question or view questions you have submitted to Crestron's True Blue Support, log in at <http://support.crestron.com>. First-time users will need to establish a user account.

Earliest Version Software Requirements for the PC

NOTE: Crestron recommends that you use the latest software to take advantage of the most recently released features. The latest software is available from the Crestron website.

NOTE: Crestron software and any files on the website are for authorized Crestron dealers and Crestron Authorized Independent Programmers (CAIP) only. New users may be required to register to obtain access to certain areas of the site (including the FTP site).

Crestron has developed an assortment of Windows®-based software tools to develop a Cresnet system. You can create a program to control the AMS system using the Crestron programming tools Adagio Composer, SystemBuilder or SIMPL Windows. For the minimum recommended software versions, visit the Version Tracker page of the Crestron website (www.crestron.com/versiontracker).

Programming with Adagio Composer

To add additional Crestron sources, third-party sources, and interfaces use Adagio Composer. Adagio Composer is part of the Crestron SystemBuilder application which can be downloaded from the Crestron website.

Adagio Composer provides a quick method of configuring a custom audio distribution system without prior programming knowledge. For additional details, download Adagio Composer from the Crestron website and examine the extensive help file.

To create more advanced systems that include non-audio distribution devices such as lighting and HVAC, use Crestron SystemBuilder or SIMPL Windows.

Programming with Crestron SystemBuilder

The easiest method of programming a Crestron system. For additional details, download SystemBuilder from the Crestron website and examine the extensive help file.

Any program created for the AMS with SystemBuilder will include the out-of-the-box functionality in addition to any additional programming created with SystemBuilder.

Programming with SIMPL Windows

NOTE: While SIMPL Windows can be used to program the AMS, it is recommended to use Adagio Composer, SystemBuilder, and Pro Sound Tools for configuring a system.

SIMPL Windows is Crestron's premier software for programming Crestron control systems. It is organized into two separate, but equally important "Managers".

NOTE: When programming an AMS in SIMPL Windows, always begin with the example program and modify as required. To find example programs, refer to "Example Program" on page 99. Also visit Crestron's True Blue Support on the web for more programming tips.

Configuration Manager

Configuration Manager is the view where programmers "build" a Crestron control system by selecting hardware from the *Device Library*.

- To incorporate the AMS into the system, drag the AMS from the Control Systems folder of the *Device Library* and drop it in the *System Views*.

Locating the AMS in the Device Library

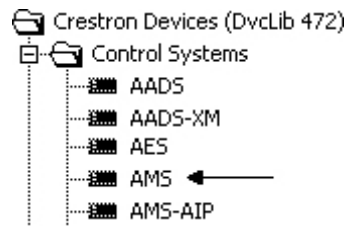

Program Manager

Program Manager is the view where programmers "program" a Crestron control system by assigning signals to symbols.

The symbol can be viewed by double clicking on the icon or dragging it into *Detail View*. Each signal in the symbol is described in the SIMPL Windows help file (**F1**).

Programming with VisionTools Pro-e

VisionTools Pro-e (VT Pro-e) is used to design pages for the front panel that can be triggered from the **HOUSE** button, and page flips.

For more information, refer to the VT Pro-e help file (**F1**).

Configuring the AMS

Use Pro Sound Tools software to configure the rooms and theater connected to the AMS. For more information, refer to the Pro Sound Tools help file.

Switching Programs

If a custom program is loaded into the AMS, the AMS will run the custom program when it boots up. To switch to the out-of-the-box program:

1. Press and release **HW-R**.
2. Press and hold **SW-R** until "Bypassing Custom Program, Running OOTBF" is displayed on the LCD.
3. To return to the custom program simply press **HW-R** or cycle power.

Saving Settings

Settings such as tone/volume levels (out-of-the-box and custom programs) and input/output names (out-of-the-box programs) are stored in an xml and text file that can be recalled should a AMS program need to be updated.

To save settings for later use, use the Crestron Toolbox File Manager utility to retrieve the **.xml* (where * can be "ootbf" for settings made when running the out-of-the-box functionality program or "custom" for settings made when running a custom program) and *System Configuration.txt* files from the NVRAM Disk directory. After the new out-of-the-box functionality program or custom program has been loaded, use Windows Explorer and Crestron Toolbox' File Manager utility to place the appropriate **.xml* and *System Configuration.txt* files in the NVRAM Disk directory and reboot the processor. For instructions on using Crestron Toolbox' File Manager utility, refer to the Crestron Toolbox help file.

NOTE: If switching to a different type of program (i.e. from out-of-the-box functionality to custom or vice-versa), the retrieved xml file can be renamed (*ootbf.xml* becomes *custom.xml* and *custom.xml* becomes *ootbf.xml*). The running program will import any relevant settings. Verify that all of the required settings are correct.

Example Program

An example program for the AMS is available from the Crestron website (<http://www.crestron.com/exampleprograms>).

Uploading and Upgrading

Crestron recommends using the latest programming software and that each device contains the latest firmware to take advantage of the most recently released features. However, before attempting to upload or upgrade it is necessary to establish communication. Once communication has been established, files (for example, programs or firmware) can be transferred to the control system (and/or device). Finally, program checks can be performed (such as changing the device ID or creating an IP table) to ensure proper functioning.

While the next section provides an overview for communication, refer to “Establishing Communications with the Control System” in the Crestron 2-Series Control Systems Reference Guide (Doc. 6256) for connection details. If communications cannot be established, refer to “Troubleshooting Communications” in the same guide.

Establishing Communication

Use Crestron Toolbox for communicating with the AMS; refer to the Crestron Toolbox help file for details. There are three methods of communication.

Direct Serial

NOTE: Serial Communication or USB communication (see below) must be used for initial setup of Ethernet parameters when the out-of-the-box functionality is not used.

Direct Serial Communication

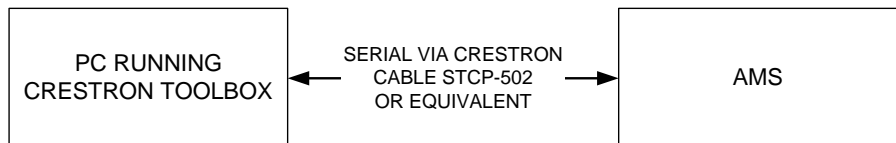



- The **COMPUTER** port on the AMS connects to the serial port on the PC via the included serial cable (Crestron STCP-502PC or equivalent).
- Use the Address Book in Crestron Toolbox to create an entry using the expected serial communication protocol (RS232, auto-detect baud rate, no parity, 8 data bits, 1 stop bit, XON/XOFF disabled, RTS/CTS enabled).
- Display the AMS’ “System Info” window (click the  icon); communications are confirmed when the device information is displayed.

USB

NOTE: USB Communication or Serial communication (shown above) must be used for initial setup of Ethernet parameters when the out-of-the-box functionality is not used.

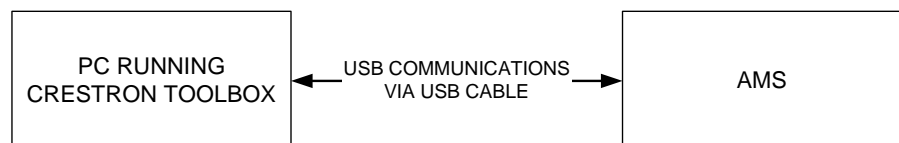
USB Communication



- The **USB** port on the AMS connects to the USB port on the PC via the included USB cable.
- Use the Address Book in Crestron Toolbox to create an entry using the expected communication protocol (USB). When multiple USB devices are connected, identify the AMS by entering “AMS” in the *Model* textbox, the unit’s serial number in the *Serial* textbox or the unit’s hostname in the *Hostname* textbox. The hostname can be found in the “System Info” window in the section marked *Ethernet* however, communications must be established in order to see this information in the “System Info” window.
- Display the AMS’ “System Info” window (click the  icon); communications are confirmed when the device information is displayed.

TCP/IP

NOTE: A connection to an Ethernet network is required for operation with a CEN-IDOC, AAS, or any other TCP/IP enabled device.

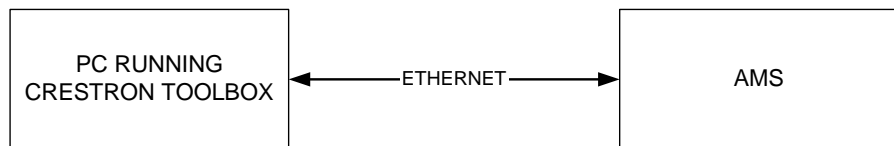
Ethernet Communication

- Establish serial or USB communication between AMS and PC.
- Enter the IP address, IP mask, and default router of the AMS via Crestron Toolbox (**Functions | Ethernet Addressing**); otherwise enable DHCP.

NOTE: When taken out of the box, the AMS is configured for DHCP operation. If a DHCP server is available and the AMS is connected to the network, the IP address can be obtained from the *About* screen as described on page 57.

- Confirm Ethernet connections between AMS and PC. If connecting through a hub, use CAT5 straight through cables with 8-pin RJ-45 connectors. Alternatively, Use a CAT5 crossover cable to connect the two **LAN** ports directly, without using a hub.
- Use the Address Book in Crestron Toolbox to create an entry for the AMS with the AMS’ TCP/IP communication parameters.
- Display the “System Info” window (click the  icon) and select the AMS entry. Communications are confirmed when the device information is displayed.

Programs and Firmware

Program or firmware files may be distributed from programmers to installers or from Crestron to dealers. Firmware upgrades are available from the Crestron website as new features are developed after product releases. One has the option to upload programs via the programming software or to upload and upgrade via the Crestron Toolbox. For details on uploading and upgrading, refer to the SIMPL Windows help file or the Crestron Toolbox help file.

SIMPL Windows

If a SIMPL Windows program is provided, it can be uploaded to the control system using SIMPL Windows or Crestron Toolbox.

Firmware

Check the Crestron website to find the latest firmware. (New users may be required to register to obtain access to certain areas of the site, including the FTP site.)

Upgrade AMS firmware via Crestron Toolbox.

- Establish serial, USB, or TCP/IP communications with the AMS and display the “System Info” window.
- Select **Functions | Firmware...** to upgrade the AMS firmware.

For details on uploading and upgrading, refer to the SIMPL Windows help file or the Crestron Toolbox help file.

Problem Solving

Troubleshooting

The following table provides corrective action for possible trouble situations. If further assistance is required, please contact a Crestron customer service representative.

AMS Troubleshooting

TROUBLE	POSSIBLE CAUSE(S)	CORRECTIVE ACTION
AMS does not function.	AMS is not receiving power.	Use the provided power cord. Verify connection.
C2N-DBF12 or APAD does not function.	AMS is not communicating with C2N-DBF12 or APAD devices.	Verify that C2N-DBF12 and APAD devices are properly connected to the AMS and are identified by the AMS as described on page 55.
AMS only allows six rooms (maximum) when using the out-of-the-box functionality.	A AE is not properly connected to the AMS.	Verify that the AAE is properly connected to the AMS.
	A AE is not registered with AMS.	Open Installer Tools and select "Identify Keypads". Identify all keypads in the system.
		Use Crestron Toolbox to manually set the AAEs Net ID to 31.
Buttons on AAE do not light or do anything	A AE is not properly connected to the AMS.	Verify that the AAE is properly connected to the AMS.
	A AE is not registered with AMS.	Open Installer Tools and select "Identify Keypads". Identify all keypads in the system.
		Use Crestron Toolbox to manually set AAE Net ID to 31.
Tuner cards are not listed on the LCD or APAD as available sources.	Tuner card is not properly installed.	Refer to the tuner card's guide for installation instructions.
CEN-IDOC or AAS devices not listed on the LCD or APAD as available sources.	CEN-IDOC or AAS are not receiving power.	Verify that each device is receiving power.
	CEN-IDOC or AAS are not communicating with AMS over Ethernet.	Verify each device's TCP/IP settings.

(Continued on following page)

AMS Troubleshooting (Continued)

TROUBLE	POSSIBLE CAUSE(S)	CORRECTIVE ACTION
Sound is not heard.	Theater and rooms are not configured correctly.	Verify theater and room configuration.
	Room is muted or turned off.	Turn off mute function or route a source to the room.
	Volume is turned down.	Raise volume to an audible level.
	Speakers are not properly connected.	Verify speaker connections.
	Source is not selected/properly connected.	Verify that source is selected and properly connected.

Check Network Wiring

Use the Right Wire

In order to ensure optimum performance over the full range of your installation topology, Crestron Certified Wire, and only Crestron Certified Wire, may be used. Failure to do so may incur additional charges if support is required to identify performance deficiencies because of using improper wire.

Calculate Power

CAUTION: Use only Crestron power supplies for Crestron equipment. Failure to do so could cause equipment damage or void the Crestron warranty.

CAUTION: Provide sufficient power to the system. Insufficient power can lead to unpredictable results or damage to the equipment. Please use the Crestron Power Calculator to help calculate how much power is needed for the system (<http://www.crestron.com/calculators>).

When calculating the length of wire for a particular Cresnet run, the wire gauge and the Cresnet power usage of each network unit to be connected must be taken into consideration. Use Crestron Certified Wire only. If Cresnet units are to be daisy-chained on the run, the Cresnet power usage of each network unit to be daisy-chained must be added together to determine the Cresnet power usage of the entire chain. If the unit is home-run from a Crestron system power supply network port, the Cresnet power usage of that unit is the Cresnet power usage of the entire run. The wire gauge and the Cresnet power usage of the run should be used in the following equation to calculate the cable length value on the equation's left side.

Cable Length Equation

$$L < \frac{40,000}{R \times P}$$

Where: L = Length of run (or chain) in feet
 R = 6 Ohms (Crestron Certified Wire: 18 AWG (0.75 MM²))
 or 1.6 Ohms (Cresnet HP: 12 AWG (4 MM²))
 P = Cresnet power usage of entire run (or chain)

Make sure the cable length value is less than the value calculated on the right side of the equation. For example, a Cresnet run using 18 AWG Crestron Certified Wire and drawing 20 watts should not have a length of run more than 333 feet. If Cresnet HP is used for the same run, its length could extend to 1250 feet.

NOTE: All Crestron certified Cresnet wiring must consist of two twisted pairs. One twisted pair is the +24V conductor and the GND conductor and the other twisted pair is the Y conductor and the Z conductor.

Strip and Tin Wire

When daisy-chaining Cresnet units, strip the ends of the wires carefully to avoid nicking the conductors. Twist together the ends of the wires that share a pin on the

network connector, and tin the twisted connection. Apply solder only to the ends of the twisted wires. Avoid tinning too far up the wires or the end becomes brittle. Insert the tinned connection into the Cresnet connector and tighten the retaining screw. Repeat the procedure for the other three conductors.

Add Hubs

For larger networks (i.e., greater than 28 network devices), it may become necessary to add a Cresnet Hub/Repeater (CNXHUB) to maintain signal quality throughout the network. Also, for networks with lengthy cable runs, it may be necessary to add a Hub/Repeater after only 20 devices.

Reference Documents

The latest version of all documents mentioned within the guide can be obtained from the Crestron website (<http://www.crestron.com/manuals>). This link will provide a list of product manuals arranged in alphabetical order by model number.

List of Related Reference Documents

DOCUMENT TITLE
2-Series Control Systems Reference Guide
AAE Audio Expander
AAS Audio Server
AMS QuickStart Guide
APAD Wall Mount LCD Controller
ATC-AMFM2 Dual AM/FM Tuner Card
ATC-AMFMSR AM/FM/SIRIUS Tuner Card
ATC-AMFMXM AM/FM/XM Tuner Card
C2N-DBF12 Decorator Wall Panels
CEN-IDOC Interface for Apple iPod®
Crestron e-Control Reference Guide
Crestron Professional Surround Sound Tuning Kit
Crestron Safety Instructions
User Interface Device Out-Of-The-Box Functionality Guide

Further Inquiries

If you cannot locate specific information or have questions after reviewing this guide, please take advantage of Crestron's award winning customer service team by calling Crestron at 1-888-CRESTRON [1-888-273-7876].

You can also log onto the online help section of the Crestron website (<http://www.crestron.com/onlinehelp>) to ask questions about Crestron products. First-time users will need to establish a user account to fully benefit from all available features.

Future Updates

As Crestron improves functions, adds new features, and extends the capabilities of the AMS, additional information may be made available as manual updates. These updates are solely electronic and serve as intermediary supplements prior to the release of a complete technical documentation revision.

Check the Crestron website periodically for manual update availability and its relevance. Updates are identified as an "Addendum" in the Download column.

Software License Agreement

This License Agreement (“Agreement”) is a legal contract between you (either an individual or a single business entity) and Crestron Electronics, Inc. (“Crestron”) for software referenced in this guide, which includes computer software and as applicable, associated media, printed materials and “online” or electronic documentation (the “Software”).

BY INSTALLING, COPYING OR OTHERWISE USING THE SOFTWARE, YOU REPRESENT THAT YOU ARE AN AUTHORIZED DEALER OF CRESTRON PRODUCTS OR A CRESTRON AUTHORIZED INDEPENDENT PROGRAMMER AND YOU AGREE TO BE BOUND BY THE TERMS OF THIS AGREEMENT. IF YOU DO NOT AGREE TO THE TERMS OF THIS AGREEMENT, DO NOT INSTALL OR USE THE SOFTWARE.

IF YOU HAVE PAID A FEE FOR THIS LICENSE AND DO NOT ACCEPT THE TERMS OF THIS AGREEMENT, CRESTRON WILL REFUND THE FEE TO YOU PROVIDED YOU (1) CLICK THE DO NOT ACCEPT BUTTON, (2) DO NOT INSTALL THE SOFTWARE AND (3) RETURN ALL SOFTWARE, MEDIA AND OTHER DOCUMENTATION AND MATERIALS PROVIDED WITH THE SOFTWARE TO CRESTRON AT: CRESTRON ELECTRONICS, INC., 15 VOLVO DRIVE, ROCKLEIGH, NEW JERSEY 07647, WITHIN 30 DAYS OF PAYMENT.

LICENSE TERMS

Crestron hereby grants You and You accept a nonexclusive, nontransferable license to use the Software (a) in machine readable object code together with the related explanatory written materials provided by Crestron (b) on a central processing unit (“CPU”) owned or leased or otherwise controlled exclusively by You and (c) only as authorized in this Agreement and the related explanatory files and written materials provided by Crestron.

If this software requires payment for a license, you may make one backup copy of the Software, provided Your backup copy is not installed or used on any CPU. You may not transfer the rights of this Agreement to a backup copy unless the installed copy of the Software is destroyed or otherwise inoperable and You transfer all rights in the Software.

You may not transfer the license granted pursuant to this Agreement or assign this Agreement without the express written consent of Crestron.

If this software requires payment for a license, the total number of CPU’s on which all versions of the Software are installed may not exceed one per license fee (1) and no concurrent, server or network use of the Software (including any permitted back-up copies) is permitted, including but not limited to using the Software (a) either directly or through commands, data or instructions from or to another computer (b) for local, campus or wide area network, internet or web hosting services or (c) pursuant to any rental, sharing or “service bureau” arrangement.

The Software is designed as a software development and customization tool. As such Crestron cannot and does not guarantee any results of use of the Software or that the Software will operate error free and You acknowledge that any development that You perform using the Software or Host Application is done entirely at Your own risk.

The Software is licensed and not sold. Crestron retains ownership of the Software and all copies of the Software and reserves all rights not expressly granted in writing.

OTHER LIMITATIONS

You must be an Authorized Dealer of Crestron products or a Crestron Authorized Independent Programmer to install or use the Software. If Your status as a Crestron Authorized Dealer or Crestron Authorized Independent Programmer is terminated, Your license is also terminated.

You may not rent, lease, lend, sublicense, distribute or otherwise transfer or assign any interest in or to the Software.

You may not reverse engineer, decompile or disassemble the Software.

You agree that the Software will not be shipped, transferred or exported into any country or used in any manner prohibited by the United States Export Administration Act or any other export laws, restrictions or regulations (“Export Laws”). By downloading or installing the Software You (a) are certifying that You are not a national of Cuba, Iran, Iraq, Libya, North Korea, Sudan, Syria or any country to which the United States embargoes goods (b) are certifying that You are not otherwise prohibited from receiving the Software and (c) You agree to comply with the Export Laws.

If any part of this Agreement is found void and unenforceable, it will not affect the validity of the balance of the Agreement, which shall remain valid and enforceable according to its terms. This Agreement may only be modified by a writing signed by an authorized officer of Crestron. Updates may be licensed to You by Crestron with additional or different terms. This is the entire agreement between Crestron and You relating to the Software and it supersedes any prior representations, discussions, undertakings, communications or advertising relating to the Software. The failure of either party to enforce any right or take any action in the event of a breach hereunder shall constitute a waiver unless expressly acknowledged and set forth in writing by the party alleged to have provided such waiver.

If You are a business or organization, You agree that upon request from Crestron or its authorized agent, You will within thirty (30) days fully document and certify that use of any and all Software at the time of the request is in conformity with Your valid licenses from Crestron or its authorized agent.

Without prejudice to any other rights, Crestron may terminate this Agreement immediately upon notice if you fail to comply with the terms and conditions of this Agreement. In such event, you must destroy all copies of the Software and all of its component parts.

PROPRIETARY RIGHTS

Copyright. All title and copyrights in and to the Software (including, without limitation, any images, photographs, animations, video, audio, music, text and “applets” incorporated into the Software), the accompanying media and printed materials and any copies of the Software are owned by Crestron or its suppliers. The Software is protected by copyright laws and international treaty provisions. Therefore, you must treat the Software like any other copyrighted material, subject to the provisions of this Agreement.

Submissions. Should you decide to transmit to Crestron’s website by any means or by any media any materials or other information (including, without limitation, ideas, concepts or techniques for new or improved services and products), whether as information, feedback, data, questions, comments, suggestions or the like, you agree such submissions are unrestricted and shall be deemed non-confidential and you automatically grant Crestron and its assigns a non-exclusive, royalty-free, worldwide, perpetual, irrevocable license, with the right to sublicense, to use, copy, transmit, distribute, create derivative works of, display and perform the same.

Trademarks. CRESTRON and the Swirl Logo are registered trademarks of Crestron Electronics, Inc. You shall not remove or conceal any trademark or proprietary notice of Crestron from the Software including any back-up copy.

GOVERNING LAW

This Agreement shall be governed by the laws of the State of New Jersey, without regard to conflicts of laws principles. Any disputes between the parties to the Agreement shall be brought in the state courts in Bergen County, New Jersey or the federal courts located in the District of New Jersey. The United Nations Convention on Contracts for the International Sale of Goods shall not apply to this Agreement.

CRESTRON LIMITED WARRANTY

CRESTRON warrants that: (a) the Software will perform substantially in accordance with the published specifications for a period of ninety (90) days from the date of receipt and (b) that any hardware accompanying the Software will be subject to its own limited warranty as stated in its accompanying written material. Crestron shall, at its option, repair or replace or refund the license fee for any Software found defective by Crestron if notified by you within the warranty period. The foregoing remedy shall be your exclusive remedy for any claim or loss arising from the Software.

CRESTRON shall not be liable to honor warranty terms if the product has been used in any application other than that for which it was intended or if it as been subjected to misuse, accidental damage, modification or improper installation procedures. Furthermore, this warranty does not cover any product that has had the serial number or license code altered, defaced, improperly obtained or removed.

Notwithstanding any agreement to maintain or correct errors or defects, Crestron shall have no obligation to service or correct any error or defect that is not reproducible by Crestron or is deemed in Crestron’s reasonable discretion to have resulted from (1) accident; unusual stress; neglect; misuse; failure of electric power, operation of the Software with other media not meeting or not maintained in accordance with the manufacturer’s specifications or causes other than ordinary use; (2) improper installation by anyone other than Crestron or its authorized agents of the Software that deviates from any operating procedures established by Crestron in the material and files provided to You by Crestron or its authorized agent; (3) use of the Software on unauthorized hardware or (4) modification of, alteration of or additions to the Software undertaken by persons other than Crestron or Crestron’s authorized agents.

ANY LIABILITY OF CRESTRON FOR A DEFECTIVE COPY OF THE SOFTWARE WILL BE LIMITED EXCLUSIVELY TO REPAIR OR REPLACEMENT OF YOUR COPY OF THE SOFTWARE WITH ANOTHER COPY OR REFUND OF THE INITIAL LICENSE FEE CRESTRON RECEIVED FROM YOU FOR THE DEFECTIVE COPY OF THE PRODUCT. THIS WARRANTY SHALL BE THE SOLE AND EXCLUSIVE REMEDY TO YOU. IN NO EVENT SHALL CRESTRON BE LIABLE FOR INCIDENTAL, CONSEQUENTIAL, SPECIAL OR PUNITIVE DAMAGES OF ANY KIND (PROPERTY OR ECONOMIC DAMAGES INCLUSIVE), EVEN IF A CRESTRON REPRESENTATIVE HAS BEEN ADVISED OF THE POSSIBILITY OF SUCH DAMAGES OR OF ANY CLAIM BY ANY THIRD PARTY. CRESTRON MAKES NO WARRANTIES, EXPRESS OR IMPLIED, AS TO TITLE OR INFRINGEMENT OF THIRD-PARTY RIGHTS, MERCHANTABILITY OR FITNESS FOR ANY PARTICULAR PURPOSE, OR ANY OTHER WARRANTIES, NOR AUTHORIZES ANY OTHER PARTY TO OFFER ANY WARRANTIES, INCLUDING WARRANTIES OF MERCHANTABILITY FOR THIS PRODUCT. THIS WARRANTY STATEMENT SUPERSEDES ALL PREVIOUS WARRANTIES.

Return and Warranty Policies

Merchandise Returns / Repair Service

1. No merchandise may be returned for credit, exchange, or service without prior authorization from CRESTRON. To obtain warranty service for CRESTRON products, contact an authorized CRESTRON dealer. Only authorized CRESTRON dealers may contact the factory and request an RMA (Return Merchandise Authorization) number. Enclose a note specifying the nature of the problem, name and phone number of contact person, RMA number, and return address.
2. Products may be returned for credit, exchange, or service with a CRESTRON Return Merchandise Authorization (RMA) number. Authorized returns must be shipped freight prepaid to CRESTRON, 6 Volvo Drive, Rockleigh, N.J. or its authorized subsidiaries, with RMA number clearly marked on the outside of all cartons. Shipments arriving freight collect or without an RMA number shall be subject to refusal. CRESTRON reserves the right in its sole and absolute discretion to charge a 15% restocking fee, plus shipping costs, on any products returned with an RMA.
3. Return freight charges following repair of items under warranty shall be paid by CRESTRON, shipping by standard ground carrier. In the event repairs are found to be non-warranty, return freight costs shall be paid by the purchaser.

CRESTRON Limited Warranty

CRESTRON ELECTRONICS, Inc. warrants its products to be free from manufacturing defects in materials and workmanship under normal use for a period of three (3) years from the date of purchase from CRESTRON, with the following exceptions: disk drives and any other moving or rotating mechanical parts, pan/tilt heads and power supplies are covered for a period of one (1) year; touchscreen display and overlay components are covered for 90 days; batteries and incandescent lamps are not covered.

This warranty extends to products purchased directly from CRESTRON or an authorized CRESTRON dealer. Purchasers should inquire of the dealer regarding the nature and extent of the dealer's warranty, if any.

CRESTRON shall not be liable to honor the terms of this warranty if the product has been used in any application other than that for which it was intended, or if it has been subjected to misuse, accidental damage, modification, or improper installation procedures. Furthermore, this warranty does not cover any product that has had the serial number altered, defaced, or removed.

This warranty shall be the sole and exclusive remedy to the original purchaser. In no event shall CRESTRON be liable for incidental or consequential damages of any kind (property or economic damages inclusive) arising from the sale or use of this equipment. CRESTRON is not liable for any claim made by a third party or made by the purchaser for a third party.

CRESTRON shall, at its option, repair or replace any product found defective, without charge for parts or labor. Repaired or replaced equipment and parts supplied under this warranty shall be covered only by the unexpired portion of the warranty.

Except as expressly set forth in this warranty, CRESTRON makes no other warranties, expressed or implied, nor authorizes any other party to offer any warranty, including any implied warranties of merchantability or fitness for a particular purpose. Any implied warranties that may be imposed by law are limited to the terms of this limited warranty. This warranty statement supersedes all previous warranties.

Trademark Information

All brand names, product names, and trademarks are the sole property of their respective owners.

Windows

Windows is a registered trademark of Microsoft Corporation. Windows95/98/Me/XP/Vista and WindowsNT/2000 are trademarks of Microsoft Corporation.

XM

The XM name and XM Ready are registered trademarks of XM Satellite Radio Inc.

SIRIUS

“SIRIUS” and the SIRIUS dog logo are registered trademarks of SIRIUS Satellite Radio Inc.

iPod

iPod is a trademark of Apple Computer, Inc., registered in the U.S. and other countries.

HDMI

HDMI, the HDMI logo and High-Definition Multimedia Interface are trademarks or registered trademarks of HDMI Licensing LLC.

Dolby

Dolby, Pro Logic, Surround EX, MLP Lossless and the double-D symbol are trademarks or registered trademarks of Dolby Laboratories.

DTS

Manufactured under license under U.S. Patent #'s: 5,451,942; 5,956,674; 5,974,380; 5,978,762; 6,226,616; 6,487,535; 7,003,467 & other U.S. and worldwide patents issued & pending. DTS, DTS Digital Surround, ES, and Neo:6 are registered trademarks and the DTS logos, Symbol and DTS 96/24 are trademarks of DTS, Inc. © 1996-2007 DTS, Inc. All Rights Reserved.

Audyssey

Audyssey MultEQ XT is a trademark of Audyssey Laboratories.



Crestron Electronics, Inc.
15 Volvo Drive Rockleigh, NJ 07647
Tel: 888.CRESTRON
Fax: 201.767.7576
www.crestron.com

Operations Guide – DOC. 6509B
(2015963)
05.08
Specifications subject to
change without notice.