



# Restaurants Title 24-2016 Solutions

Design Guide  
Crestron Electronics, Inc.

# Contents

<b>About Title 24-2016</b>	<b>1</b>
<b>Design Guide Information</b>	<b>1</b>
<b>Title 24-2016 Code Standards</b>	<b>2</b>
<b>Dining Room</b>	<b>4</b>
Zūm.....	4
GLPAC.....	5
<b>Kitchen</b>	<b>6</b>
Zūm.....	6
<b>Small Back of House / Storage</b>	<b>7</b>
Zūm.....	7
GLPP.....	8
<b>Public Restroom</b>	<b>9</b>
Zūm.....	9
GLPP.....	10

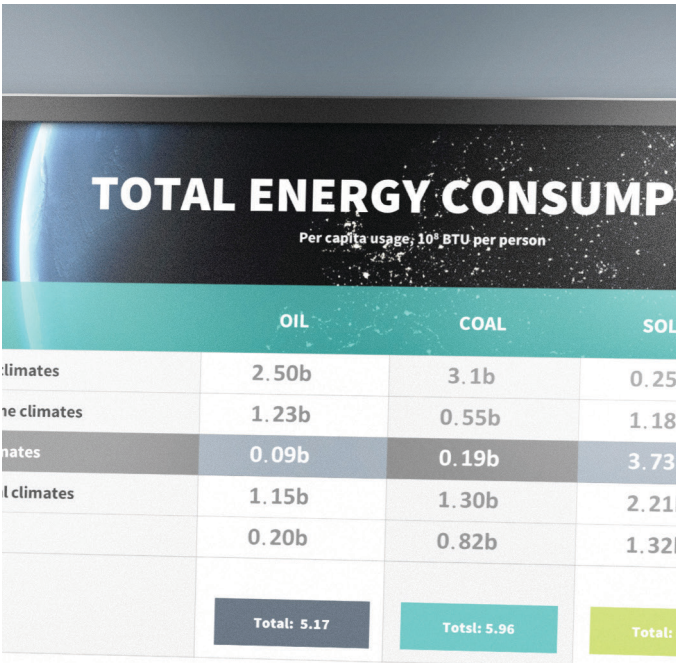

	OIL	COAL	SOLAR
All climates	2.50b	3.1b	0.25
Hot climates	1.23b	0.55b	1.18
Temperate climates	0.09b	0.19b	3.73
Cold climates	1.15b	1.30b	2.21
	0.20b	0.82b	1.32
	<b>Total: 5.17</b>	<b>Total: 5.96</b>	<b>Total: 1.32</b>



## About Title 24-2016

Title 24-2016 is a residential and commercial building energy code that is designed to reduce energy consumption. The goal of this code is to reduce energy consumption by providing design and construction requirements for lighting controls.

Lighting controls such as occupancy status sensors, multi-level controls, and demand response provisions allow you to synchronize indoor light levels with daylight levels in accordance with Title 24-2016.

## Design Guide Information

Crestron offers this Design Guide for Restaurants - Title 24-2016 solutions to use as a reference for typical layouts. Use it as guidance to make code compliance quick and easy. The Crestron team is also available to support with detailed design, submittal, and installation requirements. For additional information, please contact your Crestron representative at [CLCDesign@crestron.com](mailto:CLCDesign@crestron.com) or (888) 330-1502.

# Title 24-2016 Code Standards

## Summary

### Title 24-2016 Code Standards

	Code Provision	Minimum Control Requirement	Code Description
ON/OFF CONTROLS	130.1(a)	Local Manual Switch <sup>1</sup>	Luminaires must be controlled with accessible manual on/off local control. Each space and area enclosed by ceiling-height partitions must be independently controlled.
	130.1(b)	Multi-Level Control	Lighting of any enclosed area 100 square feet or larger with more than one luminaire and a load >0.5 W per square foot should provide multi-level lighting control that meets uniformity requirements in accordance with Title24 Table 130.1-A. Lighting control can not override local on/off or any other control requirements.
	130.1(c)	Shut-Off <sup>2</sup>	Lighting must be controlled by either 1) an occupant sensing control, 2) automatic time-switch control with 2 hour maximum override and holiday scheduling, or 3) other control capable of automatically shutting off lighting. Indoor shut-off zones must be separated using ceiling high partitions and can be no larger than one floor with a maximum of 5,000 square feet.
	130.1(c)5/6/7	Sensor Shut-Off	Occupant Sensing Controls are required to shut off all lighting. Full or partial off to at least 50% via occupant sensing controls is required.
LIGHT LEVEL CONTROL	130.1(d)	Daylight Zones <sup>3</sup>	Automatic daylighting controls should be installed and configured in all daylit zones as defined by 130.1(d). Lighting controls should have multilevel functionality to at least the number of control steps defined in Title 24 Table 130.1-A.
	130.1(e)	Demand Response Ready <sup>4</sup>	Buildings >10,000 square feet with a lighting power density ≥0.5 W per square foot are required to receive a standards-based messaging protocol, which automatically reduces lighting power by at least 15% and remains consistent with uniform illumination requirements defined in Title 24 Table 130.1-A.
PLUG LOAD CONTROL	130.5(d)	Controlled Receptacles	50% of receptacles are required to automatically turn off based on occupancy or after a vacancy of 20 minutes or less. Each uncontrolled receptacle must have at least one controlled receptacle within 6 feet.

#### Primary Solutions

Zūm™ Wireless Light Control

GLPP

GLPAC

- General lighting must be separately controlled from all other lighting systems in an area. Floor and wall display, window display, case display, track, ornamental, and special effects lighting should be separately controlled and placed on circuits that are 20 amps or less.
- Countdown timer switches should not be used to comply with the automatic shut-off control requirements in Section 130.1(c)1, except in single-stall bathrooms and closets that are <70 square feet where the lights must shut off within ten minutes, or in a server aisle/room where the lights must shut off within 30 minutes.
- The photosensor should be readily accessible to authorized personnel for calibration adjustments. To prevent unauthorized access, the photosensor may be mounted inside a case that is secured with a locking mechanism.
- Add a networked Crestron control system for demand response (130.5(d)) control. For networked Zūm applications, add a ZUM-FLOOR-HUB and ZUMNET-GATEWAY for demand response.

Space Type				
Small Back of House / Storage ≤250 square feet	Restroom	Restaurant Dining		Kitchen
✓	✓	✓		✓
✓	✓	✓		✓
✓	✓	✓		✓
✓				
✓	✓	✓		✓
✓	✓	✓		✓
✓				✓
✓	✓	✓		✓
✓	✓			
		✓		

# Dining Room

Zūm™

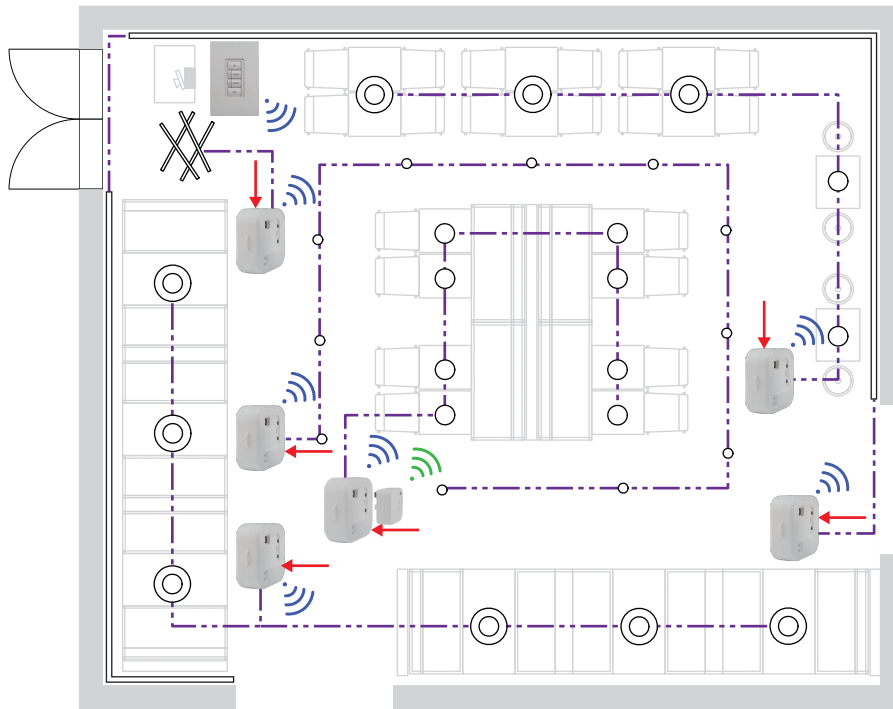

- ▶ Daylight zones (130.1(d)) may be required if windows are present.
- ▶ Restaurants do not require automatic time-switch control with an automatic holiday shut-off feature.



## Title 24-2016 Code Compliance:

- ▶ Local Manual Switch (130.1(a))
- ▶ Multi-Level Control (130.1(b))
- ▶ Shut-Off (130.1(c))
- ▶ Demand Response Ready (130.1(e))

## Local Control:



## GLZUM-6JBOX\_LV5A-1CKP\_BATT-NET

Symbol	Qty.	Product	Description
	6	ZUMMESH-JBOX-5A-LV	Zūm™ Junction Box Zone Controller, 0-10 V Dimming, 5 A
	1	ZUMMESH-NETBRIDGE	Zūm™ Network Bridge
	1	ZUMMESH-KP10CBATT	6-Button Battery-Powered Keypad

# Dining Room

## GLPAC

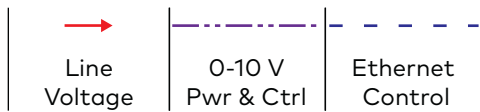
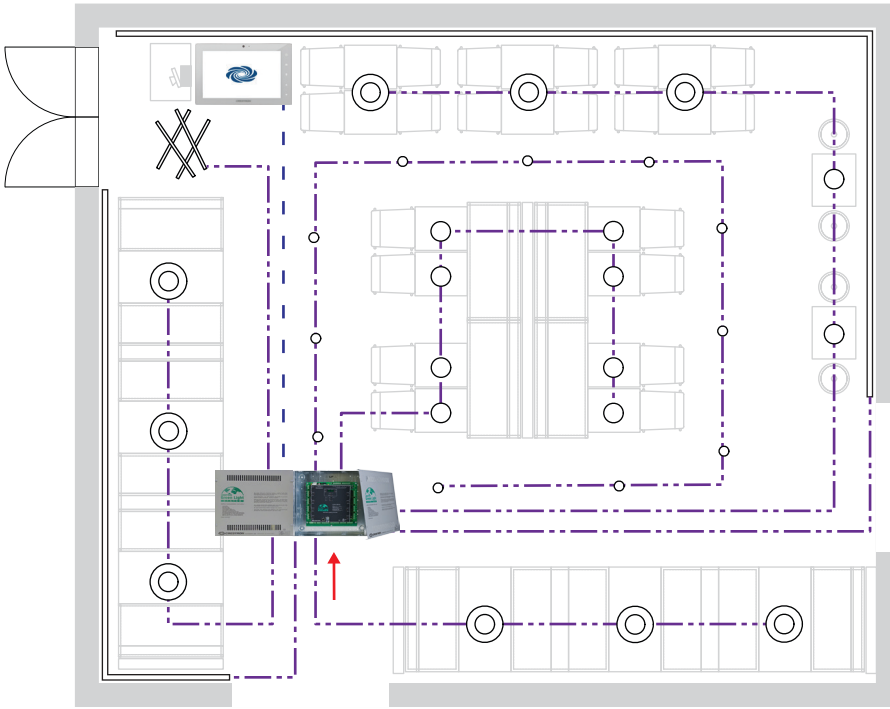

- ▶ Daylight zones (130.1(d)) may be required if windows are present.
- ▶ Restaurants do not require automatic time-switch control with an automatic holiday shut-off feature.



### Title 24-2016 Code Compliance:

- ▶ Local Manual Switch (130.1(a))
- ▶ Multi-Level Control (130.1(b))
- ▶ Shut-Off (130.1(c))
- ▶ Demand Response Ready (130.1(e))

### Local Control:



## GLPAC4-TS7-NET

Symbol	Qty.	Product	Description
	1	GLPAC-DIMFLV4	Crestron Green Light® Integrated Lighting System, 4-Channel
	1	TSW-760	7 in. Touch Screen
	1	CLP-HUB-SW-POE-5	Contains a DIN-CENCN-2, a DIN-PWS60, and a CEN-SW-POE-5 in a DIN-EN-2X18 cabinet

# Kitchen

Zūm™

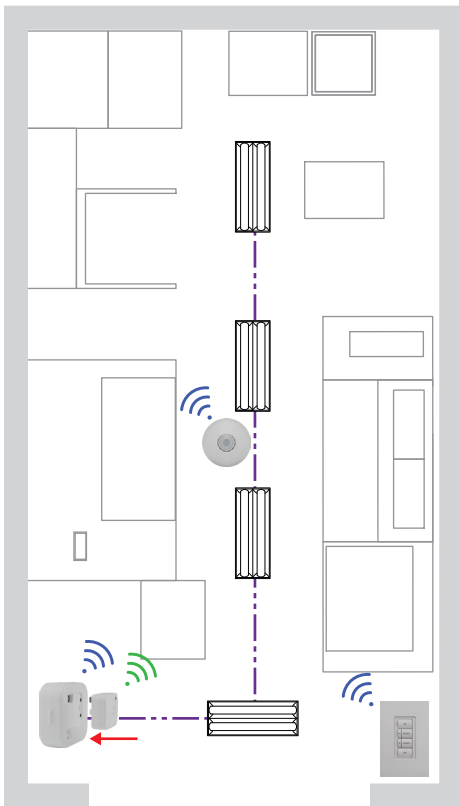

- ▶ Daylight zones (130.1(d)) may be required if windows are present.





## Title 24-2016 Code Compliance:

- ▶ Local Manual Switch (130.1(a))
- ▶ Multi-Level Control (130.1(b))
- ▶ Shut-Off (130.1(c))
- ▶ Demand Response Ready (130.1(e))
- ▶ Controlled Receptacle (130.5(d))

## Local Control:



## GLZUM-1JBOX\_LV5A-1CKP\_BATT-1PIR\_BATT-NET

Symbol	Qty.	Product	Description
	1	ZUMMESH-JBOX-5A-LV	Zūm™ Junction Box Zone Controller, 0-10 V Dimming, 5 A
	1	ZUMMESH-NETBRIDGE	Zūm™ Network Bridge
	1	ZUMMESH-KP10CBATT	6-Button Battery-Powered Keypad
	1	ZUMMESH-PIR-VACANCY-BATT	PIR Vacancy Sensor (AUTO-OFF)



# Small Back of House / Storage

## Zūm

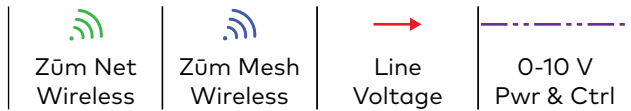
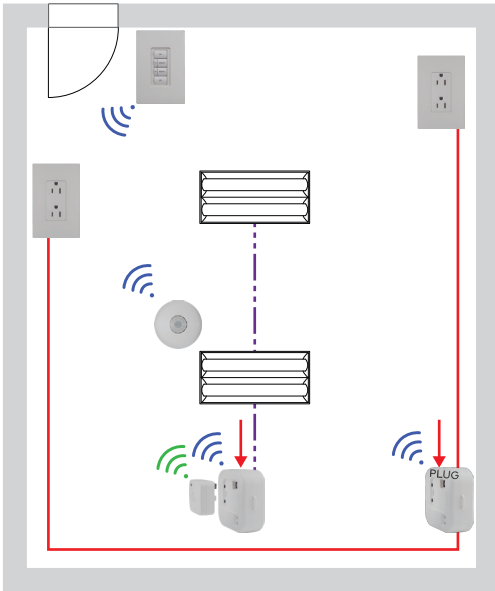

▶ Daylight zones (130.1(d)) may be required if windows are present.





### Title 24-2016 Code Compliance:

- ▶ Local Manual Switch (130.1(a))
- ▶ Multi-Level Control (130.1(b))
- ▶ Shut-Off (130.1(c))
- ▶ Sensor Shut-Off (130.1(c)5/6/7)
- ▶ Demand Response Ready (130.1(e))
- ▶ Controlled Receptacle (130.5(d))

### Local Control:



### GLZUM-1LV-1PL-2CKP\_BATT-1PIR\_BATT-NET

Symbol	Qty.	Product	Description
	1	ZUMMESH-JBOX-5A-LV	Zūm™ Junction Box Zone Controller, 0-10 V Dimming, 5 A
	1	ZUMMESH-JBOX-20A-PLUG	Zūm™ J-Box Load Controller, Plug Load Switch
	1	ZUMMESH-NETBRIDGE	Zūm™ Network Bridge
	1	ZUMMESH-KP10CBATT	6-Button Battery Powered Keypad
	1	ZUMMESH-PIR-VACANCY-BATT	PIR Vacancy Sensor (AUTO-OFF)

# Small Back of House / Storage

## GLPP

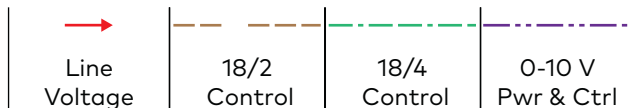
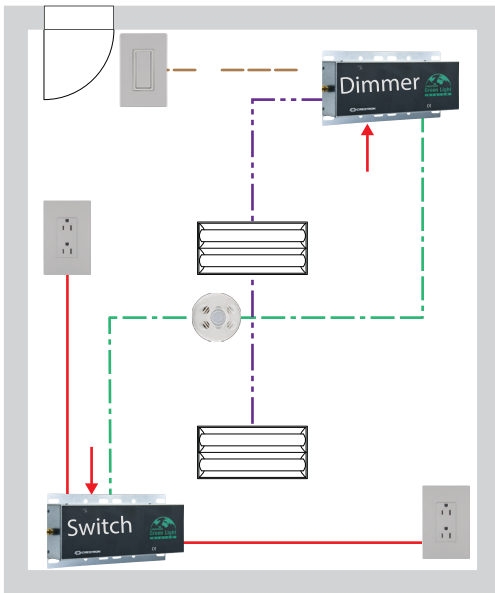

▶ Daylight zones (130.1(d)) may be required if windows are present.

## Title 24-2016 Code Compliance:

- ▶ Local Manual Switch (130.1(a))
- ▶ Multi-Level Control (130.1(b))
- ▶ Shut-Off (130.1(c))
- ▶ Sensor Shut-Off (130.1(c)5/6/7)
- ▶ Demand Response Ready (130.1(e))
- ▶ Controlled Receptacle (130.5(d))

## Local Control:



## GLPP-3DIM-JKP-1OS-LOL-NET-1PL

Symbol	Qty.	Product	Description
	1	GLPP-DIMFLVCN-PM	1-Ch 0-10 V Dimmer with Cresnet® Control
	1	GLPP-SWCN	Cresnet Green Light® Power Pack, 1-Channel Switch with Cresnet® Control
	1	GLPPA-KP	In-Wall Keypad for GLPP
	1	GLS-ODT-C-NS	Dual-Technology Ceiling Mount Occupancy Sensor, 2000 sq ft

# Public Restroom

Zūm™

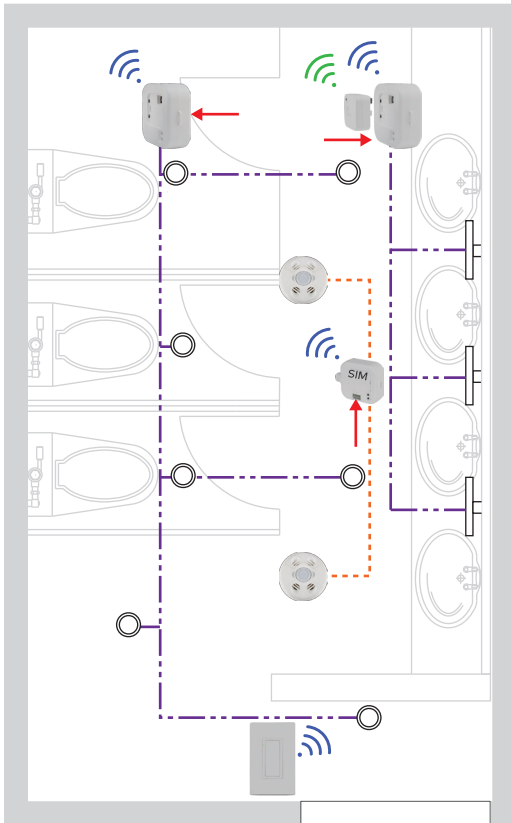

## Title 24-2016 Code Compliance:



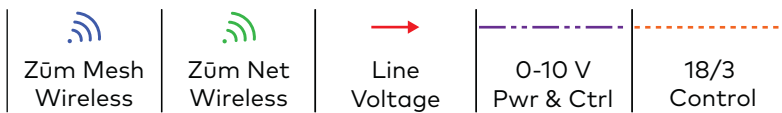

- ▶ Local Manual Switch (130.1(a))
- ▶ Multi-Level Control (130.1(b))
- ▶ Shut-Off (130.1(c))
- ▶ Demand Response Ready (130.1(e))

## Local Control:



- ▶ Public restrooms with two or more stalls may use a manual control not accessible to unauthorized personnel.
- ▶ Daylight zones (130.1(d)) may be required if windows are present.
- ▶ Public restrooms should have at least one control step between 30-70% of full rated power.

## GLZUM-2JBOX\_LV5A-AKP\_BATT-2OS-NET

Symbol	Qty.	Product	Description
	2	ZUMMESH-JBOX-5A-LV	Zūm™ Junction Box Zone Controller, 0-10 V Dimming, 5 A
	1	ZUMMESH-JBOX-SIM	Zūm™ Junction Box Sensor Integration Module
	1	ZUMMESH-NETBRIDGE	Zūm™ Network Bridge
	1	ZUMMESH-KP10ABATT	Rocker-Button Battery Powered Keypad
	2	GLS-ODT-C-NS	Dual-Technology Ceiling Mount Occupancy Sensor

# Public Restroom

## GLPP

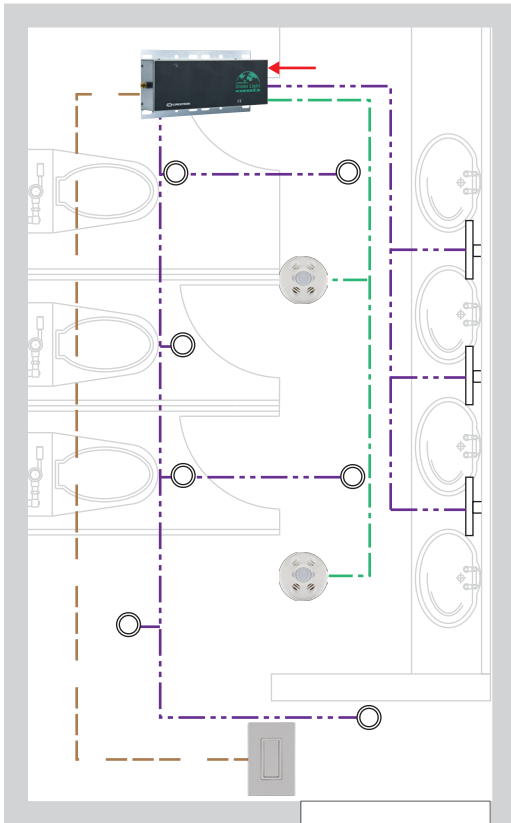

### Title 24-2016 Code Compliance:



- ▶ Local Manual Switch (130.1(a))
- ▶ Multi-Level Control (130.1(b))
- ▶ Shut-Off (130.1(c))
- ▶ Demand Response Ready (130.1(e))

### Local Control:



- ▶ Public restrooms with two or more stalls may use a manual control not accessible to unauthorized personnel.
- ▶ Daylight zones (130.1(d)) may be required if windows are present.
- ▶ Public restrooms should have at least one control step between 30-70% of full rated power.

### GLPP-2DIM-JKP-2OS-NET

Product	Qty.	Product	Description
	1	GLPP-1DIMFLV2CN-PM	2-Ch 0-10 V Dimmer with Cresnet® Control
	1	GLPPA-KP	In-Wall Keypad for GLPP
	2	GLS-ODT-C-NS	Dual-Technology Ceiling Mount Occupancy Sensor

Notes

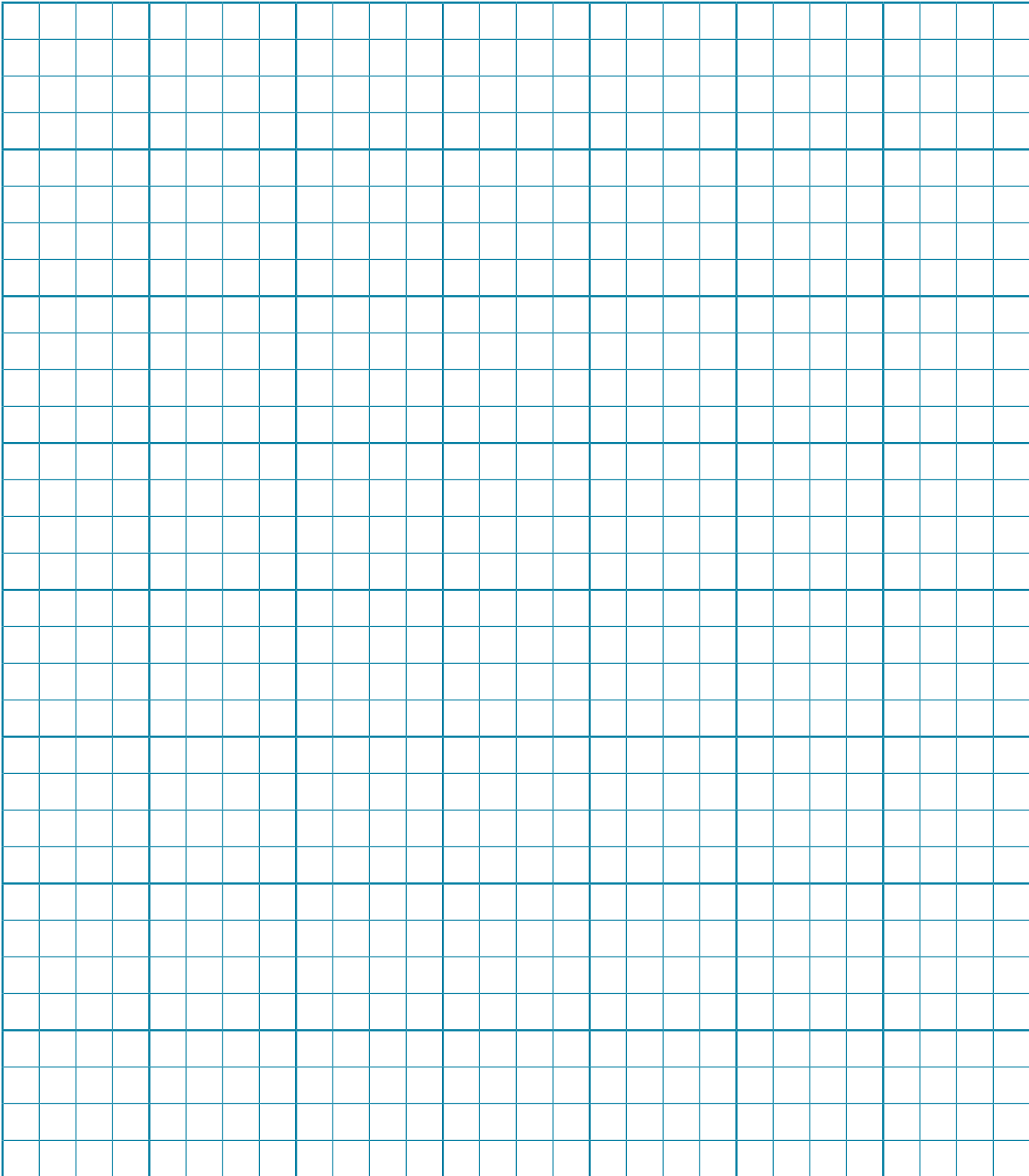

## Notes

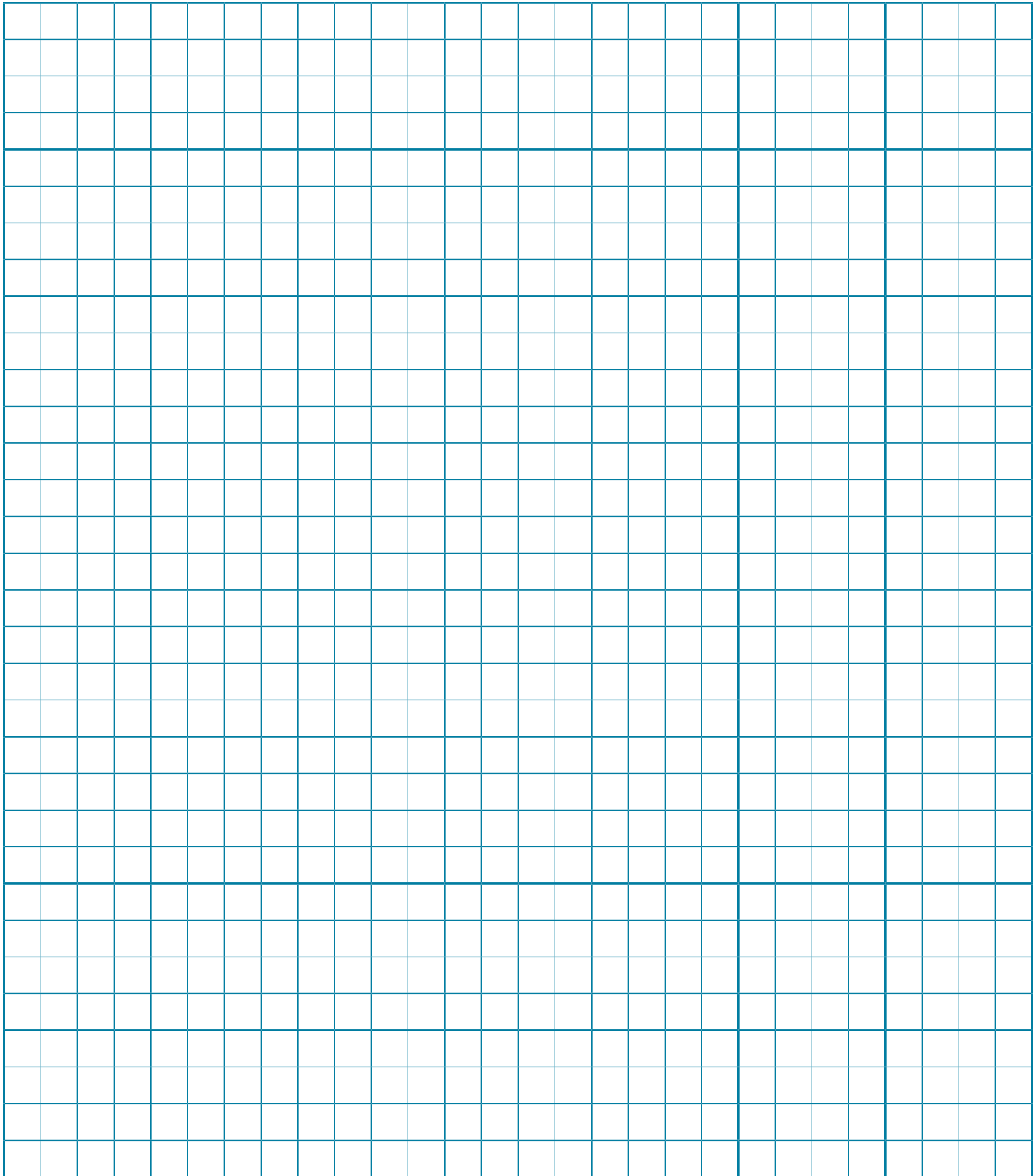

Crestron, the Crestron logo, Cresnet, Crestron Green Light, Cameo, and Züm are either trademarks or registered trademarks of Crestron Electronics, Inc. in the United States and/or other countries. Other trademarks, registered trademarks, and trade names may be used in this document to refer to either the entities claiming the marks and names or their products. Crestron disclaims any proprietary interest in the marks and names of others. Crestron is not responsible for errors in typography or photography.

This document was written by the Technical Publications department at Crestron Electronics, Inc.

©2019 Crestron Electronics, Inc.

