

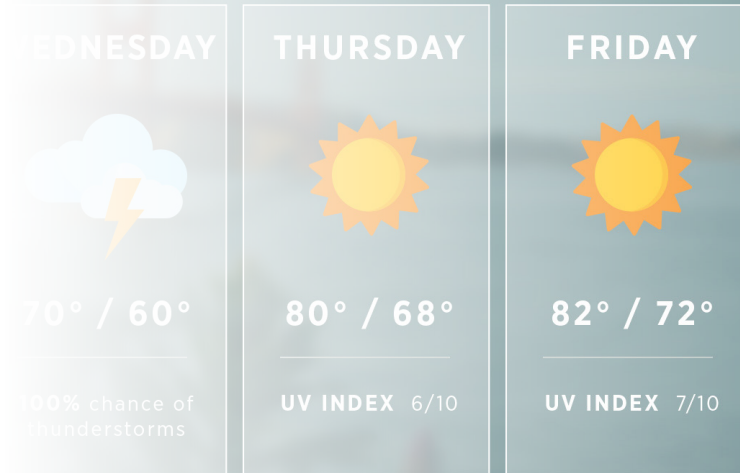

DM NVX[®] AV over IP
Design Guide

YES.

Any network, Any ask.
DM NVX says yes.



world news



DM NVX Endpoints

MULTISOURCE-TO-DISPLAY

Reliable, high-performance AV over IP encoders or decoders that transports 4K60 4:4:4 video over standard Gigabit Ethernet with no perceptible latency or loss of quality. It provides a secure, scalable 4K signal routing solution for enterprise and campus-wide content distribution applications.



KEY BENEFITS

- 4K60, 4:4:4, with HDR video quality
- Ultra-Fast No Glitch Switching
- USB 2.0 Routing
- PoE+
- HDMI Inputs & Outputs w/ 4K60 4:4:4 scaler built in
- OPS (Open Pluggable Specification) Support
- Full surround audio, breakaway audio, built in DSP for Downmix
- Dante & AES67 Support available
- CEC
- Enterprise security



Products

For full product line and more information visit <https://www.crestron.com/Products/Featured-Solutions/DigitalMedia-NVX-Series>

DM NVX ENDPOINTS



DM-NVX-352

DM NVX 4K60 4:4:4 HDR Network AV Encoder/Decoder with Dante® Network Audio & AES67 support

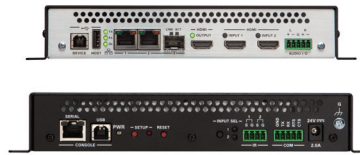

DM-NVX-351

DM NVX 4K60 4:4:4 HDR Network AV Encoder/Decoder with Downmixing



DM-NVX-350

DM NVX 4K60 4:4:4 HDR Network AV Encoder/Decoder

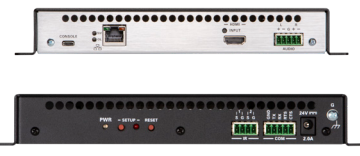

DM-NVX-E30

DM NVX 4K60 4:4:4 HDR Network AV Encoder



DM-NVX-D30

DM NVX 4K60 4:4:4 HDR Network AV Decoder



DM-NVX-D80-IOAV

DM NVX 4K60 4:4:4 HDR Network AV OPS Decoder

NEW!

DM NVX Endpoint Cards

MULTISOURCE-TO-DISPLAY

A reliable, high-performance AV over IP encoder or decoder that transports 4K60 4:4:4 video over standard Gigabit Ethernet with no perceptible latency or loss of quality. Occupies a rack-mountable card frame. Provides a secure, scalable 4K signal routing solution for enterprise and campus-wide content distribution applications.

KEY BENEFITS

- 4K60, 4:4:4, with HDR
- Ultra-Fast No Glitch Switching
- USB 2.0 Routing
- PoE+
- HDMI Inputs & Outputs w/ 4K60 4:4:4 Scaler
- OPS (Open Pluggable Specification) Support
- Full surround audio, breakaway audio, built in DSP for Downmix, Dante & AES67 Support
- CEC
- Enterprise security



Products

For full product line and more information visit <https://www.crestron.com/Products/Featured-Solutions/DigitalMedia-NVX-Series>

DM NVX CARDS



DM-NVX-352C

DM NVX 4K60 4:4:4 HDR Network AV Encoder/Decoder Card with Dante® Network Audio & AES67



DM-NVX-351C

DM NVX 4K60 4:4:4 HDR Network AV Encoder/Decoder Card with Downmixing



DM-NVX-350C

DM NVX 4K60 4:4:4 HDR Network AV Encoder/Decoder Card



DM-NVX-E30C

DM NVX 4K60 4:4:4 HDR Network AV Encoder Card



DM-NVX-D30C

DM NVX 4K60 4:4:4 HDR Network AV Decoder Card



DMF-CI-8

DigitalMedia™ Card Chassis for DM-NVX-C & DMCF, 8 Slots

DM NVX Director™ Switching Appliance

VIRTUAL DM® SWITCHER

DM NVX Director is your mission control. Configure, monitor and manage every NVX endpoint network wide with DM NVX Director. Transport video at the highest quality standard across standard ethernet infrastructure. It's a single, simple, management system.

KEY BENEFITS

- Real-time device monitoring and configuration
- Real-time signal routing
- Real-time control and monitoring of hundreds of endpoints from a single point
- Simple deployment

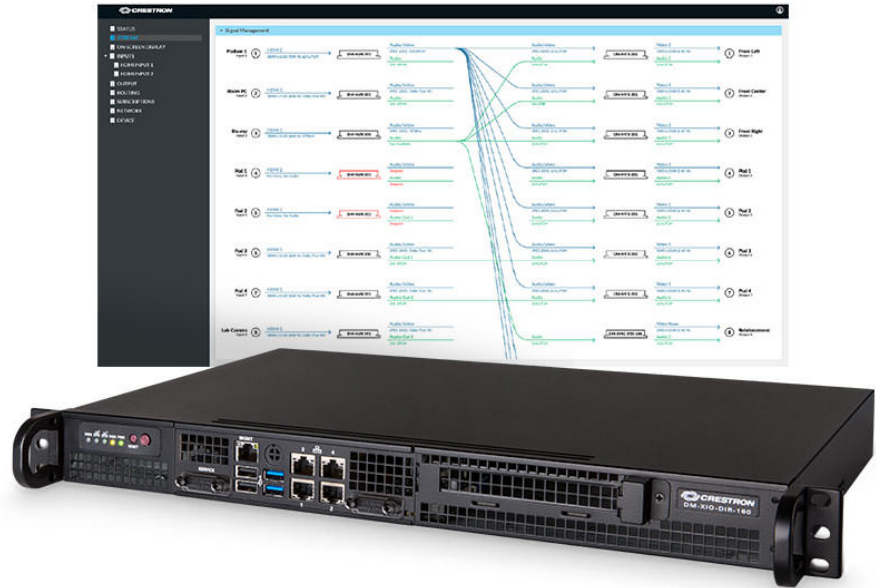

Products

For full product line and more information visit <https://www.crestron.com/Products/Featured-Solutions/DigitalMedia-NVX-Series>

VIRTUAL SWITCHING APPLIANCES



DM-XIO-DIR-80

Virtual Switching Appliance for 80 Endpoints



DM-XIO-DIR-160

Virtual Switching Appliance for 160 Endpoints



DM-XIO-DIR-ENT

Virtual Switching Appliance, Enterprise Version



ENTERPRISE

DM NVX AV over IP provides ultimate flexibility and scalability for AV presentations in meeting rooms, conference rooms and boardrooms using new or existing ethernet infrastructure. Simply add an encoder/decoder to any space to get video onto or off of the network. Use DM NVX Director™ to centrally monitor, manage, and control the entire DM NVX network.

- Meeting Rooms
- Presentation Rooms
- Executive Offices



USE CASE

- Deploy across an entire enterprise for each single office space providing a consistent user experience that is easy to use and manage

BENEFITS

- Lowest total cost of ownership using Crestron DM NVX® endpoints
- Simple end user experience using the commercial grade and purpose built TSW-760
- Display content with Zero latency to the display with DM NVX AV over IP
- Improved "quick switching" - now 500ms/2-3 frames with Crestron DM NVX endpoints
- Wirelessly present using AirMedia® wireless presentation
- Easily source content to the display using the touch screen

CONCLUSION

- Single office space with a simple user experience and content sharing using DM NVX endpoints with integrated form factor RMC3 3-Series® Room Media Controller

BOM EXAMPLE

QNTY	PRODUCT NAME
1	RMC3
1	TSW-760
1	TSW-760
1	AM-200
2	DM-NVX-350

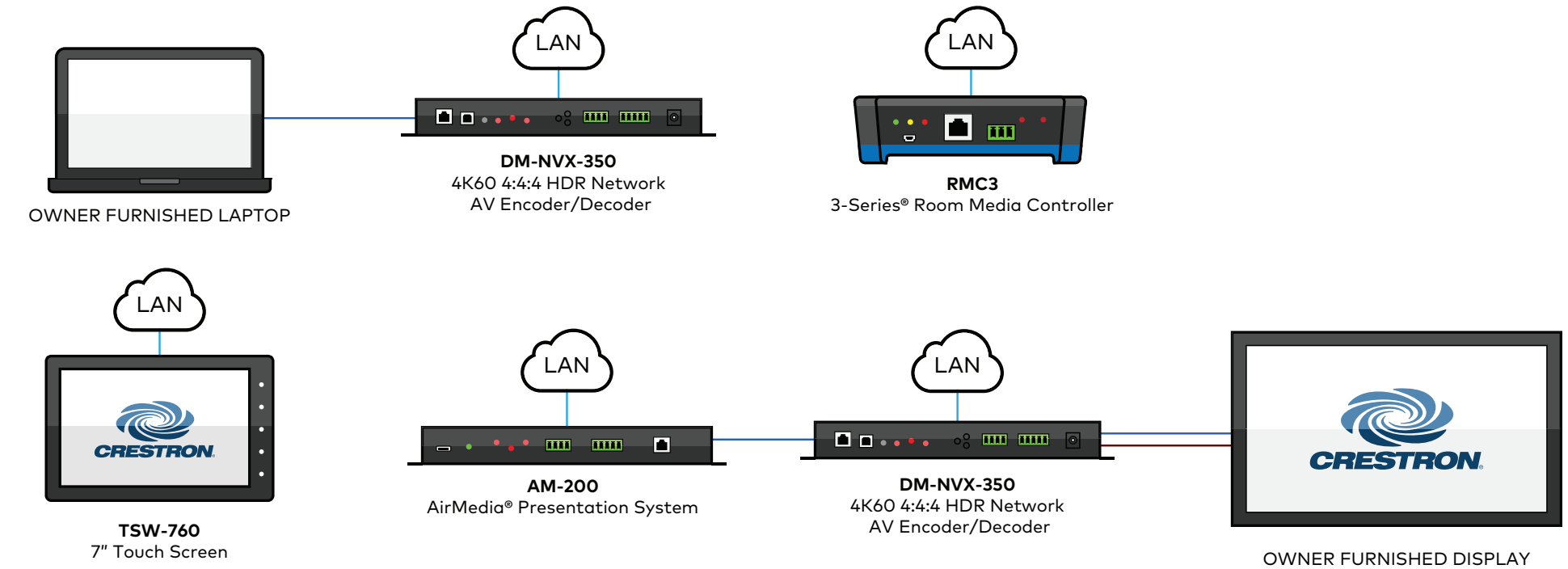

Key: ● Cat5/6 ● HDMI® Cables ● RS-232

USE CASE

- Easily deploy across an enterprise providing a simple and consistent user experience with easy room control in each room

BENEFITS

- Plug and play simplicity using a laptop to display content to the display in the room with the option of displaying content wirelessly using Crestron AirMedia® wireless presentation
- Source content using a commercial grade and purpose built touch screen
- Easily book an ad hoc meeting using the Crestron TSS room scheduling panel outside the room
- Seamlessly integrates with Crestron room scheduling panels with hardware decoupled from software so the user can use any software they would like
- Zero latency to the display utilizing DM NVX endpoints

CONCLUSION

- A small huddle space with a simple and consistent user experience that is scalable across the entire enterprise and easily accessible utilizing Crestron Room scheduling hardware

BOM EXAMPLE

QNTY	PRODUCT NAME
1	RMC3
1	CNTBLOCK
1	PW-2407RU
1	GLS-ODT-C-CN
1	TSW-760
1	TSW-760-TTK
1	TSS-7-B-S-LB KIT
1	AM-200
2	DM-NVX-350

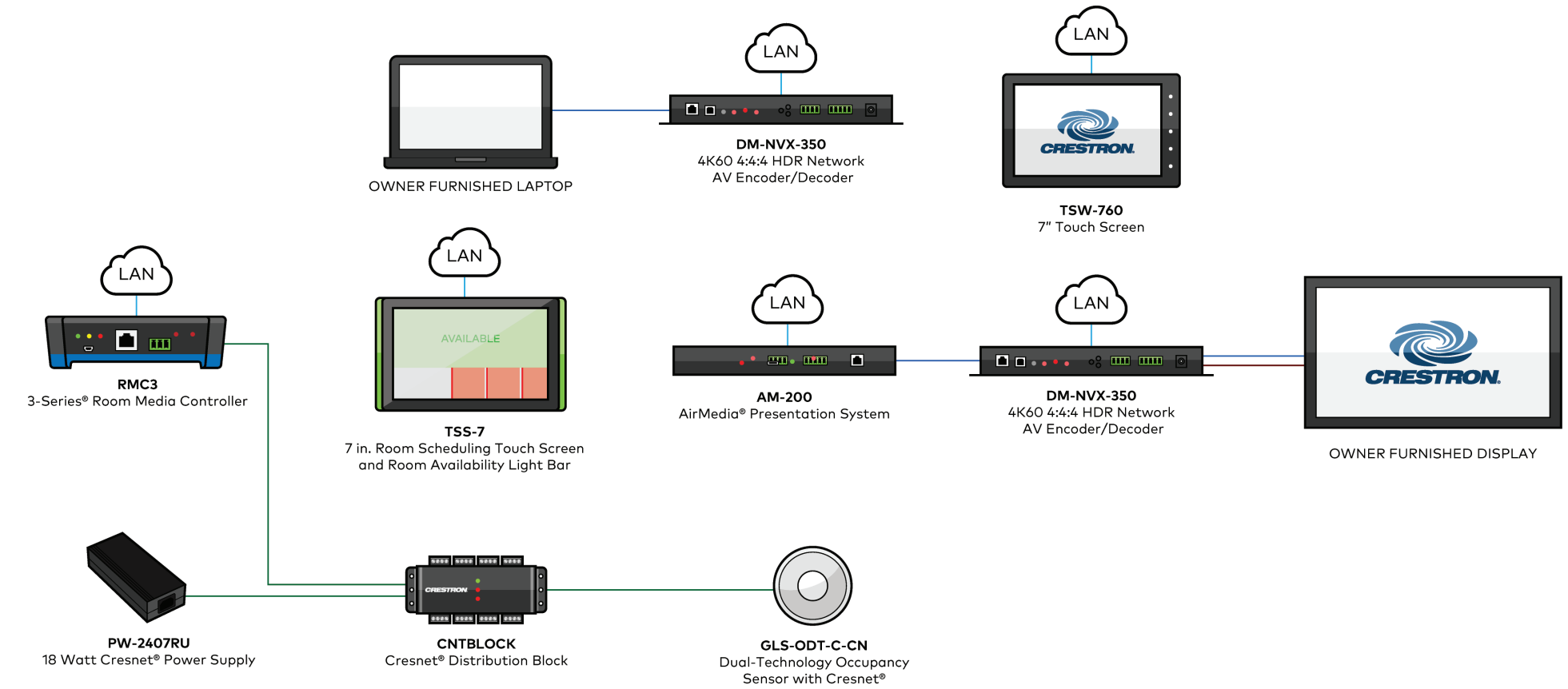

Key: ● Cat5/6 ● HDMI® Cables ● RS-232 ● Cresnet® Wire

USE CASE

- Scale across the enterprise for needs where a simple yet consistent user experience is needed while maintaining enterprise grade security

BENEFITS

- Use BYOD for collaboration using Crestron Mercury® tabletop device or native one touch join using Microsoft Teams® UC software with the UC-B140-T kit
- Native room control integration using Crestron Flex UC equipment
- Wirelessly collaborate using an AM-300
- Seamlessly collaborate with a camera, speaker, and microphone all in a single device using the UC-SB1-CAM-FLEX as part of the UC-B140-T kit
- Simple design with fewer SKUs all on a single platform
- Zero touch provisioning using the Crestron XiO Cloud™ service

CONCLUSION

- Simple and flexible conference room with for easy collaboration and meetings providing a simple user experience

BOM EXAMPLE

QNTY	PRODUCT NAME
1	RMC3
1	AM-300
1	DM-TX-4KZ-302-C
1	DM-NVX-351C
1	DM-NVX-352
1	DMF-CI-8
KIT	UC-B140-T
KIT	CCS-UC-1-AV-PLUS

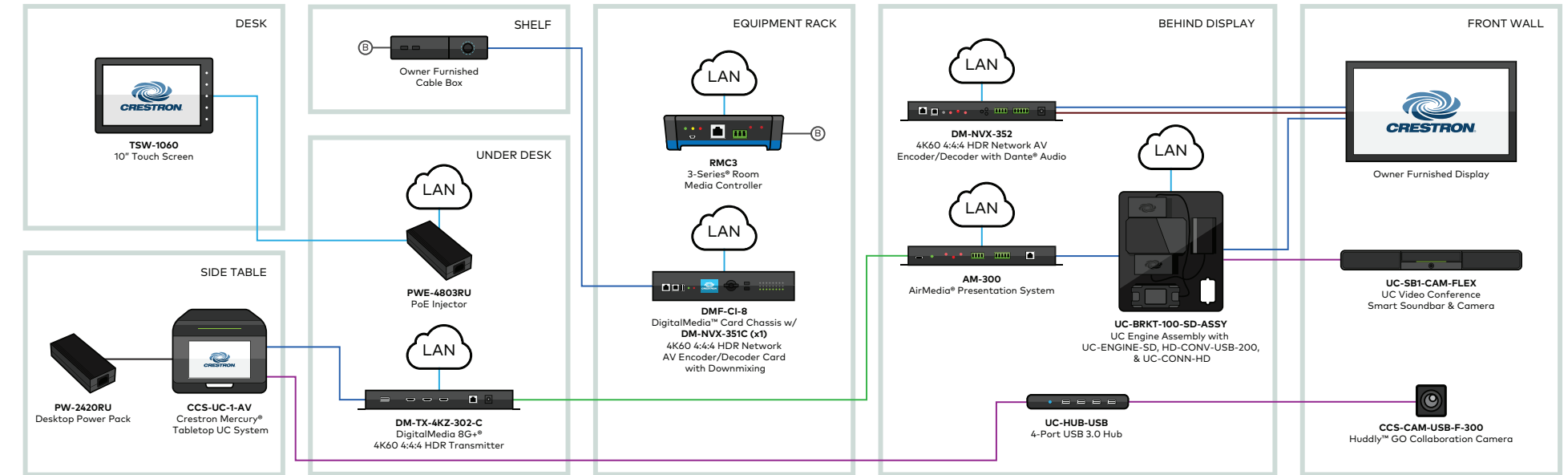

Key: ● Cat5/6 ● HDMI® Cables ● USB ● DM® Cable ● RS-233 ● IR ● Power

USE CASE

- Deploy across the enterprise where an executive boardroom is needed and easily monitor and manage utilizing Crestron XiO Cloud™ service

BENEFITS

- End users can easily plug in any device using the FT2-700-ELEC built into the table
- Route signal content to the display on the wall with DM NVX endpoints
- Improved "quick switching" - now 500ms/2-3 frames with Crestron DM NVX endpoints
- Display content wirelessly using AirMedia® wireless presentation with the AM-200
- Schedule, extend and end meetings using the TSS-10 room scheduling panels and easy room visibility with the room availability lightbar
- Hands free audio with Dante® network audio ceiling mics and Dante DSP-1283
- Seamlessly integrates with native ceiling speakers, AV over IP, DSP, AMP and room scheduling all on a single platform
- Zero touch provisioning using Crestron XiO Cloud™ service

CONCLUSION

- A boardroom displaying up to 4K60 4:4:4 content utilizing Crestron DM NVX endpoints with integrated wireless presentation, room scheduling, audio and video

BOM EXAMPLE

QNTY	PRODUCT NAME
1	CP3N
1	TSW-1060
1	TSW-1060-TTK
2	TSS-10
2	TSW-1060-LB
1	AM-200
1	USB-EXT-2
1	HD-SCALER-VGA-E
1	FT2-700-ELEC
1	FT2A-CBL-PT-4K-HD
1	FT2A-CBL-PT-4K-MDP-HD
1	FT2A-CBL-PT-VGA
1	FT2A-CBLR-GR-4K-USBC-HD
1	FT2A-CHGR-USBA/C
1	FT2A-PWR-US-1
3	DM-NVX-350
3	DM-NVX-350C
1	DMF-CI-8
1	DSP-1283
1	AMP-X300
8	DM-NVX-350

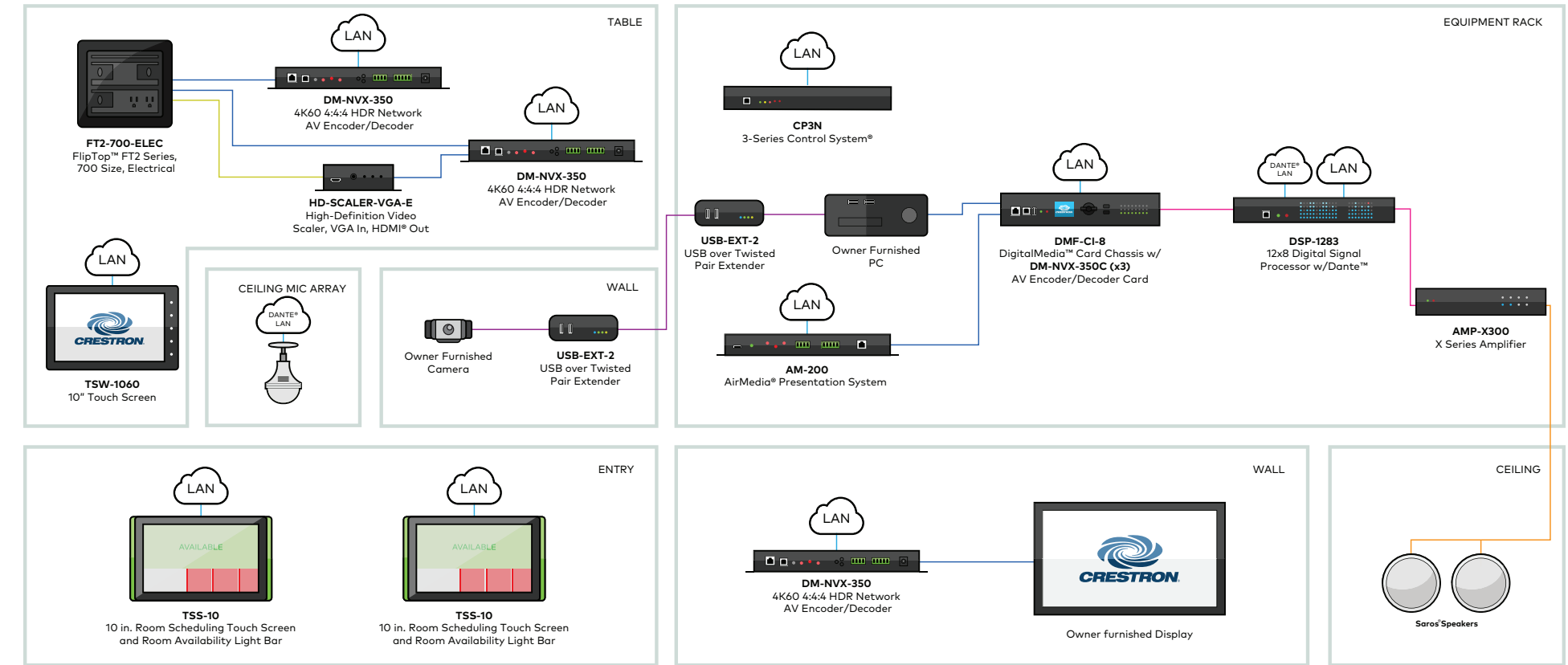

Key: ● Cat5/6 ● HDMI® Cables ● USB ● Speaker ● Audio ● RS-232 ● VGA



EDUCATION

Present stunning 4K60 content with zero latency to audiences in large spaces on multiple displays, so every seat in the house gets an unobstructed view. Also perfect for digital signage and broadcast messaging for events, meetings, menus, or weather warnings across a campus or target specific buildings or floors

- Classrooms
- Auditoriums
- Collaborative Spaces
- Lecture halls



USE CASE

- Deploy across an entire University campus and scale as part of the complete Crestron® EcoSystem providing a standard for all University classrooms

BENEFITS

- Ease of install with simple design with fewer parts, connections and less clutter all while providing a consistent user experience
- Supports standard network security policies that Universities already have in place including 802.1x authentication and Active Directory® Credential Management
- Easily control all devices from touch panel located right at the lectern
- Display different devices such as laptops, PCs and document cameras
- Students can plug their laptops into the HD-TX-201-C-E under each table displaying up to 4K60 content via DM NVX endpoints
- Source any device to any display utilizing DM NVX AV over IP and a TSW

CONCLUSION

- A flexible classroom accommodating multiple device types and simple student and instructor collaboration with easy content routing at the lectern

BOM EXAMPLE

QNTY	PRODUCT NAME
1	CP3N
1	TSW-1060
1	TSW-1060-TTK
1	TSW-560/760/1060-SMK
1	USB-EXT-2
21	DM-NVX-350
9	HD-TX-201-C-2G-E
9	HD-RX-101-C-E
1	AMP-X300
8	SAROS IC8T-W-T-EACH
1	DSP-1280

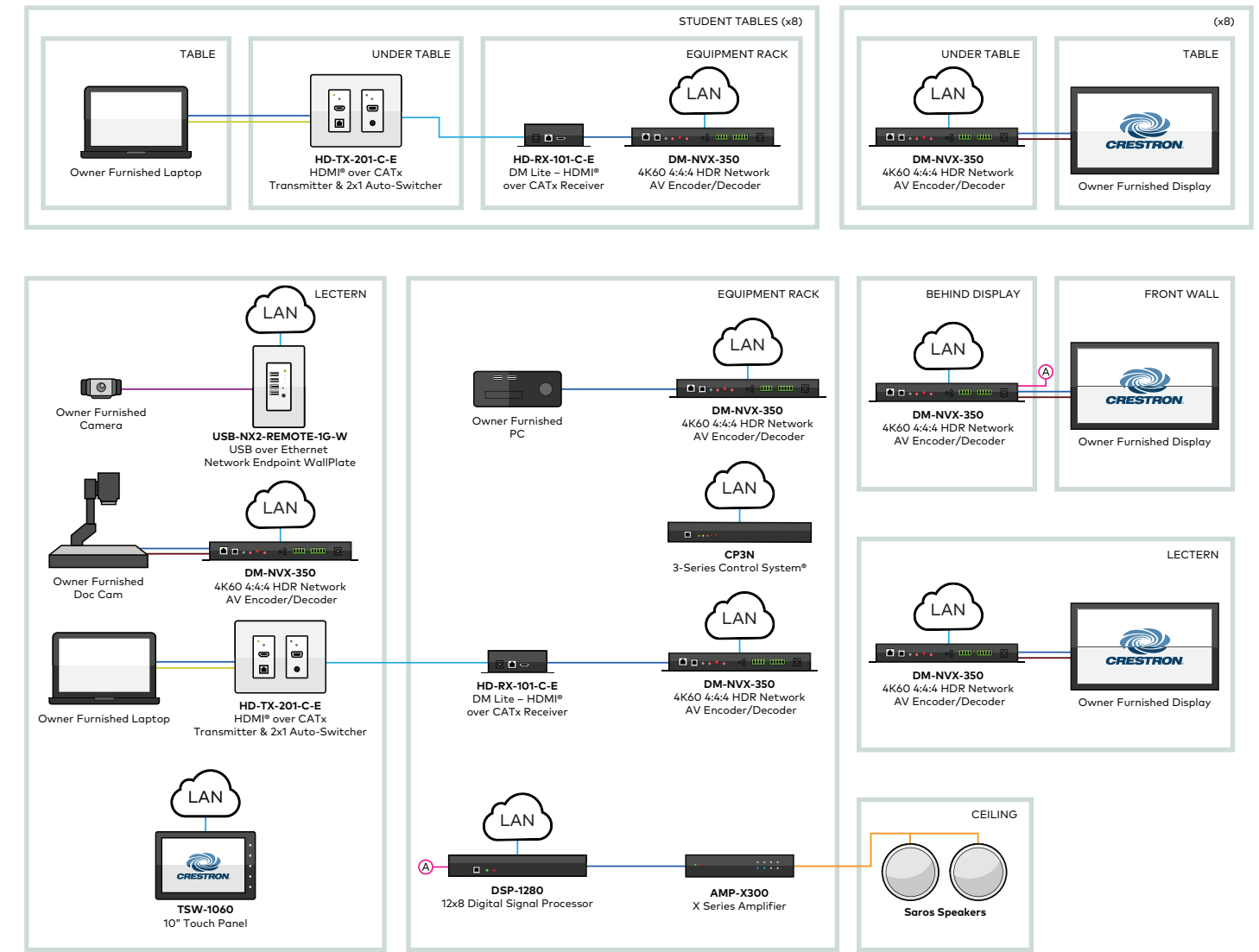

Key: ● Cat5/6 ● HDMI® Cables ● USB ● Speaker ● Audio ● RS-232 ● VGA

USE CASE

- Deploy and scale across campuses in medical buildings and schools of business that require specialized training labs

BENEFITS

- Distribute impeccable 4K60 4:4:4 HDR video throughout the space utilizing DM NVX® AV over IP
- Improved "quick switching" - now 500ms/2-3 frames with Crestron DM NVX endpoints
- Route any source such as owner furnished satellite boxes, digital signage players, and cameras, all with zero latency using DM NVX endpoints
- Instructors can collaborate easily with the students by routing their content to multiple displays from anywhere using a wireless commercial grade touch screen
- Lowest total cost of ownership using DM NVX AV over IP and Crestron XiO Cloud™ service with the ability to expand the system in the future
- Enterprise grade security at the device level such as 802.1x and Active Directory® credential management

CONCLUSION

- Flexible simulation lab with easy collaboration for students and instructors featuring DM NVX endpoints, FlipTop™ tabletop cable management and commercial grade purpose built touch screens

BOM EXAMPLE

QNTY	PRODUCT NAME
1	AV3
1	CEN-GWEXER
2	TS-1542-C
1	TST-902
1	DM-XIO-DIR-80
2	DM-PSU-ULTRA-MIDSPAN
2	DM-TX-4KZ-202-C
7	FT2-700-ELEC
14	FT2A-CBLR-1T-HD
7	FT2A-CBLR-1T-CAT6
7	FT2APWR-US-2
19	DM-NVX-350
16	DM-NVX-350C
5	DM-NVX-351C
3	DMF-CI-8

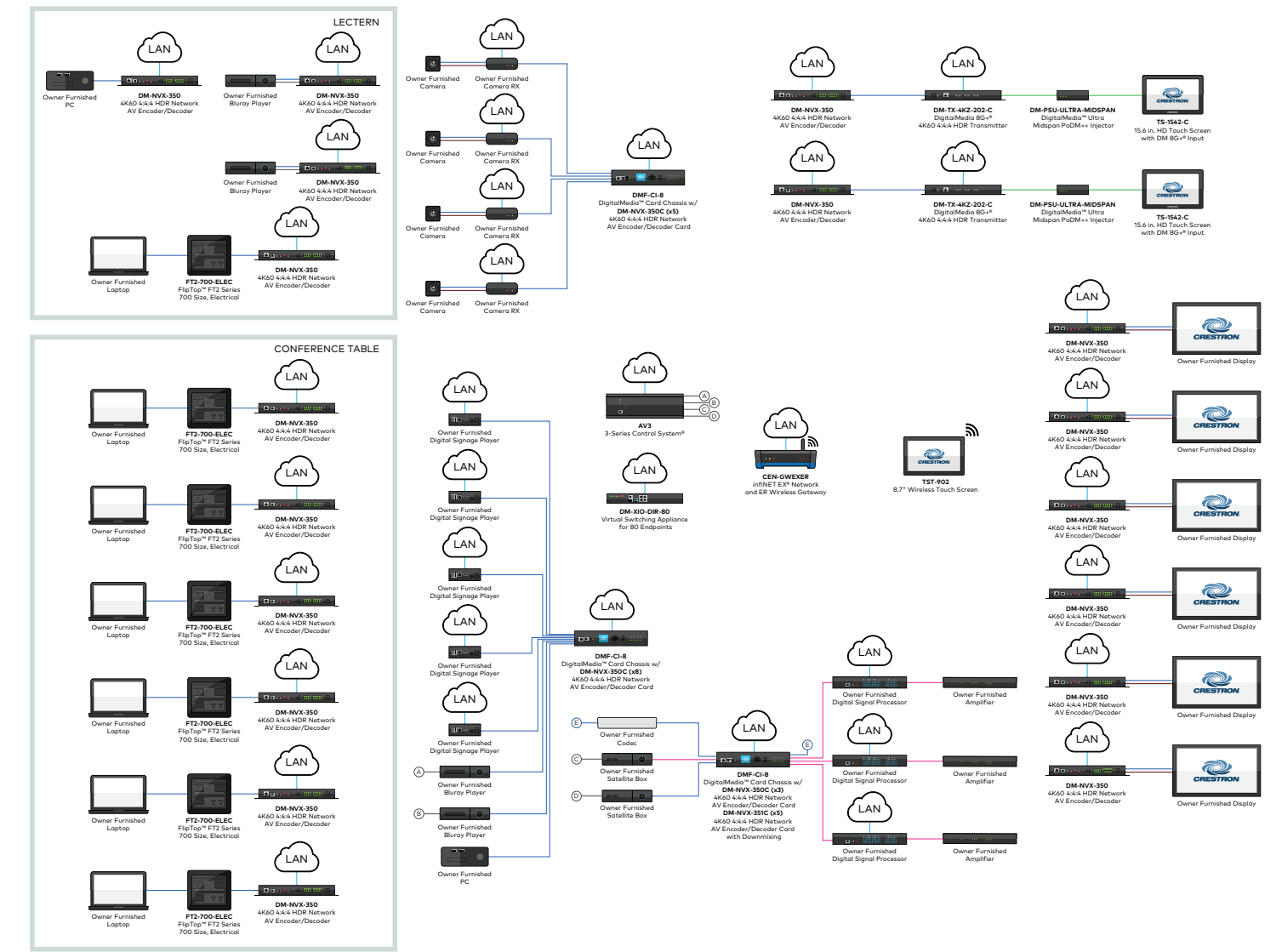

Key: ● Cat5/6 ● HDMI® Cables ● DM® Cable ● Audio ● RS-232 ● IR

Education

USE CASE

- Deploy across campus event spaces designed for specialized gaming rooms providing a simple design with seamless integration into owner furnished equipment

BENEFITS

- Seamlessly integrate with Xbox® consoles, PlayStation® consoles and others for the ultimate gaming experience
- Source and display content using a TSW-1060 10" touch panel
- Make announcements using an owner furnished microphone integrated into the DMPS-4K-250-C unit
- Crucial lag free game play allows for gamers to play without compromise utilizing DM NVX® AV over IP with 4K60 4:4:4 HDR video
- Using a DSP-1283, AMP-8075 and Saros® Speakers, hear gameplay audio distributed loud and clear

CONCLUSION

- A gaming room with zero latency to the displays integrating with multiple gaming consoles with native speakers and AV over IP units to provide the best gaming experience possible

BOM EXAMPLE

QNTY	PRODUCT NAME
1	DMPS3-4K-250-C
1	TSW-1060
1	TSW-1060-TTK
2	HD-DA2-4KZ-E
5	DM-NVX-350
1	DSP-1283
1	AMP-8075
8	SAROS IC6T-W-T-EACH
2	SAROS IC8T-W-T-EACH

Gaming Room

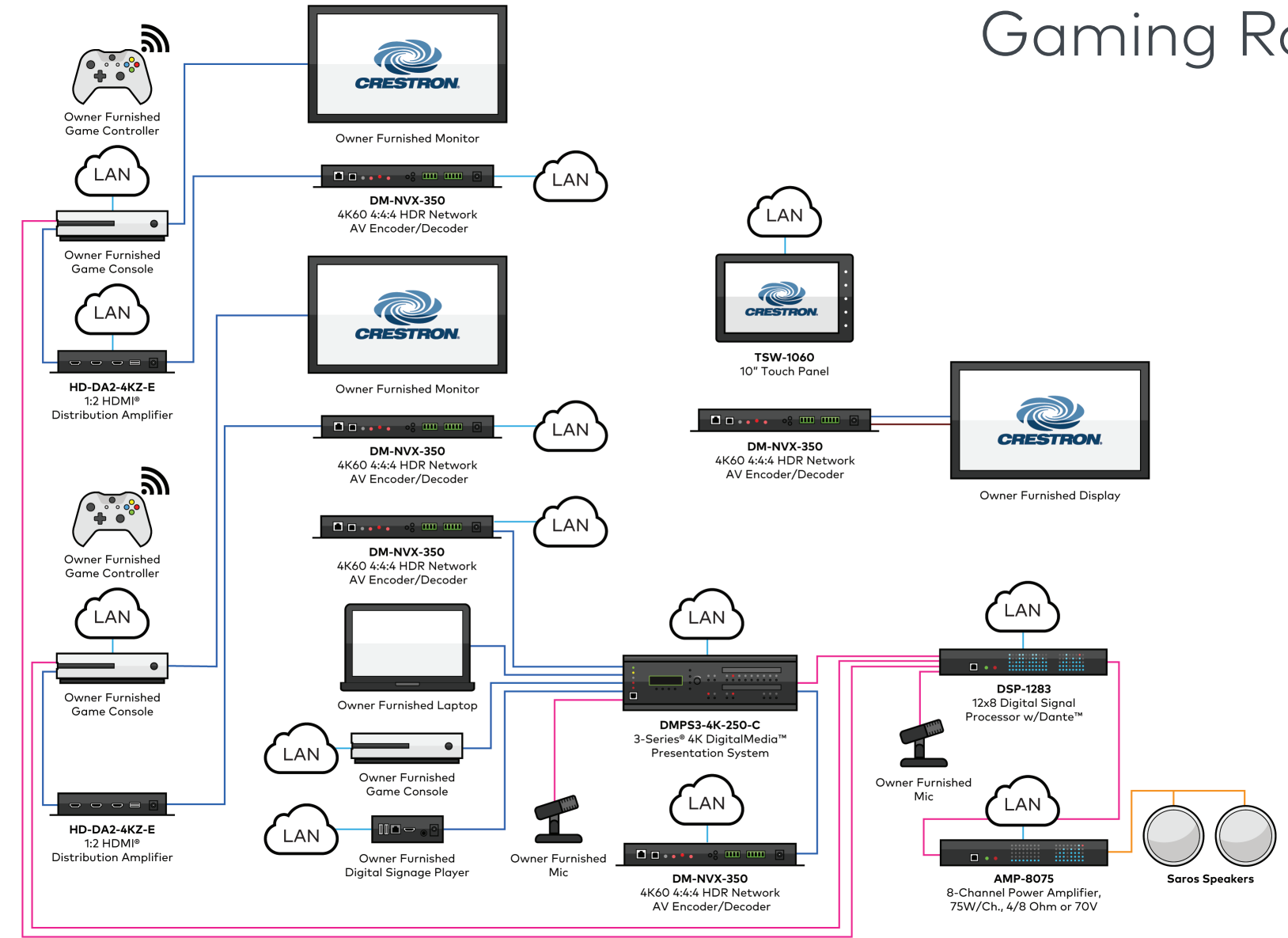

Key: ● Cat5/6 ● HDMI® Cables ● Speaker ● Audio ● RS-232



GOVERNMENT

DM NVX® Series is the first and only AV-over-IP solution to receive JITC certification and FIPS 140-2 validation, the U.S. federal government's two most rigorous security standards. This clears the way for DM NVX to be safely deployed in the most secure information network infrastructures.

- Police Headquarters
- Courtrooms
- Briefing rooms
- Presentation rooms

USE CASE

- Deploy in government secure buildings with DM NVX® endpoints meeting government's highest security standards
- Scale and easily deploy across the entire building with easy monitoring and management

BENEFITS

- Display different key pieces of content in the courtroom such as videos, still images and data to multiple displays in the courtroom for everyone to be able to see
- Route and display content anywhere using DM NVX endpoints and commercial grade and purpose built touch screens
- Hear videos, witness testimonies and more using native brand ceiling speakers
- Flexible and scalable design with zero touch provisioning and management utilizing the Crestron XiO Cloud™ service
- JITC and FIPS 140-2 certified products ensure that all content meets governments most rigorous security standards

CONCLUSION

- Fully functioning courtroom with integrated AV in all areas including the witness stand, defense and prosecution stands, judges table, clerk, lectern and gallery, providing a fully immersive experience with all parties involved.

BOM EXAMPLE

QNTY	PRODUCT NAME
1	CP3N
1	TSW-1060-NC
1	TSW-1060
4	TSW-760-NC
4	TSW-760-TTK
4	TSD-2220
5	DGE-100
1	AM-200
1	HD-DA8-4KZ-E
1	HD-MD4X1-4K-E
3	FT2-700-MECH
5	FT2A-CBLR-GR-4K-HD
3	FT2A-CHGR-USBA-BASIC
6	FT2A-PWR-US-2
16	DM-NVX-350
2	DM-NVX-350C
1	DMF-CI-8
1	DM-NVX-351C
3	DM-NVX-E30
5	DM-NVX-E30C
1	DSP-1283
1	AMP-2210HT
8	SAROS IC8T-W-T-EACH

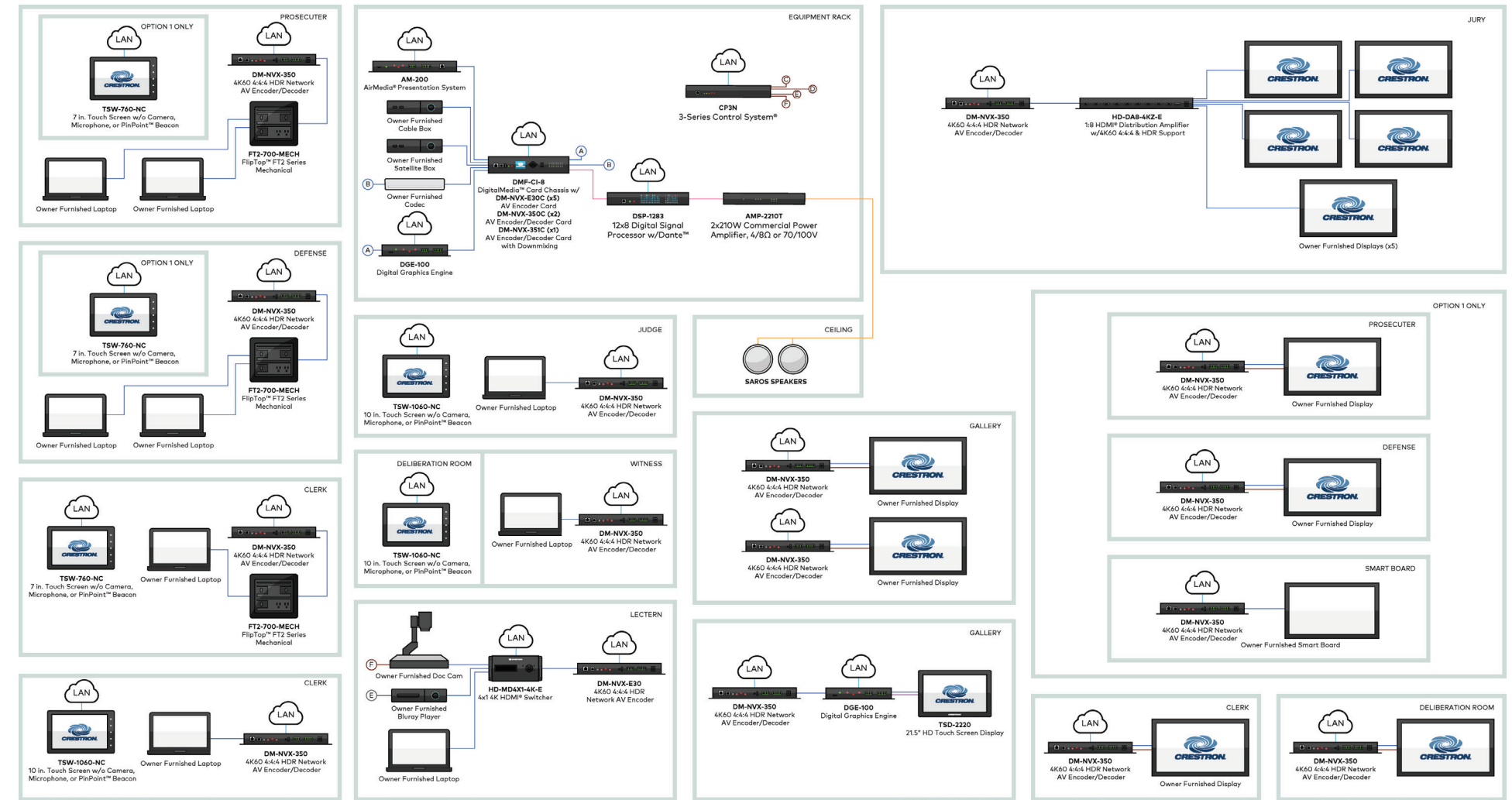

Key: ● Cat5/6 ● HDMI® Cables ● DM Lite™ Cables ● Speaker ● RS-232

USE CASE

- Deploy where a highly secure monitoring center is needed with management from anywhere and scalability across the enterprise

BENEFITS

- Display content to a video wall using DM NVX® endpoints
- Zero latency from the source to the display using DM NVX encoders and decoders so NOC analysts can diagnose problems in real time
- Improved "quick switching" - now 500ms/2-3 frames with Crestron DM NVX endpoints
- Source and display laptop and PC content using a TSW commercial grade touch screen and DM NVX endpoints
- JITC and FIPS 140-2 government certified devices ensure all content is secure
- Simple design with less SKU's

CONCLUSION

- A simple yet secure Network Operations Center providing government grade security down to the device level with an easy to use experience for end users

BOM EXAMPLE

QNTY	PRODUCT NAME
1	CP3N
1	TSW-1060
1	TSW-1060-TTK
1	GLS-ODT-C-CN
14	DM-NVX-350
4	DM-NVX-350C
1	DMF-CI-8
1	DSP-1283
1	AMP-X300
6	SAROS IC6T-W-T-EACH

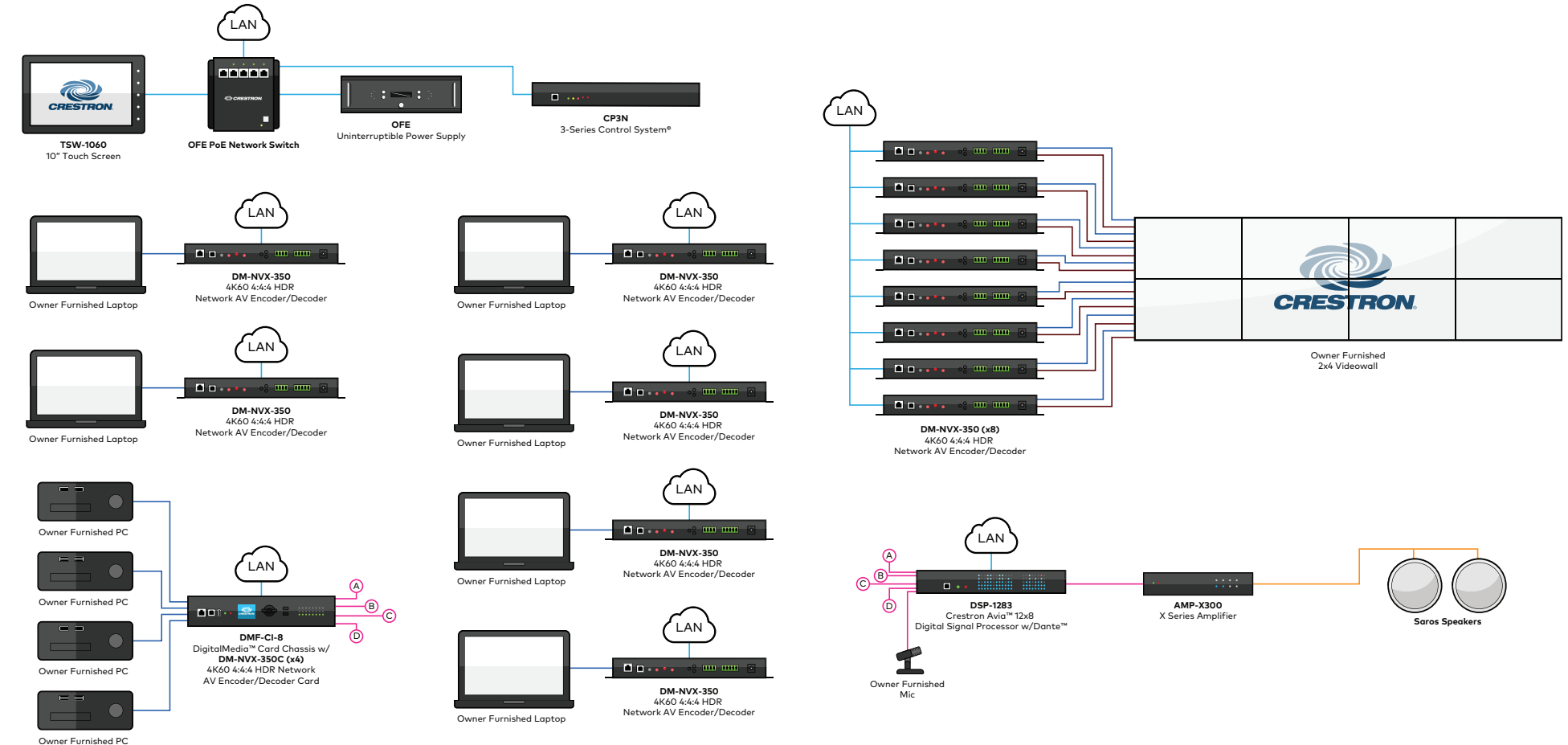

Key: ● Cat5/6 ● HDMI® Cables ● Audio ● Speaker ● RS-232



RETAIL

DM NVX® AV over IP technology brings scalable 4K60 4:4:4 HDR content into the retail space with easy control and content routing to make retailers accross the world part of the Crestron IoT ecosystem

- Retail space
- Directories (Kiosks)
- Break rooms

Retail

USE CASE

- Simple deployment and scalability across entire retail spaces, including luxury shops and common areas with easy monitoring and management

BENEFITS

- Route and source content to any screen such as digital signage players or laptop content utilizing DM NVX® endpoints
- Control content right from a PC with XPanel software transforming any PC into a Crestron® touch screen
- Configure, control and manage DM NVX endpoints using DM NVX Director™ Virtual Switching Appliance
- Improved “quick switching” - now 500ms/2-3 frames with Crestron DM NVX endpoints
- Integrates seamlessly with owner furnished equipment such as displays and digital signage players
- Award winning 24/7 Crestron True Blue support
- Fewer SKUs and low total cost of ownership using DM NVX AV over IP

CONCLUSION

- A simple retail space utilizing DM NVX endpoints for seamless content sharing throughout the space using AV over IP integrating seamlessly into owner furnished displays

BOM EXAMPLE

QNTY	PRODUCT NAME
1	CP3N
2	DMF-CI-8
40	DM-NVX-350
10	DM-NVX-350C
1	DM-XIO-DIR-80

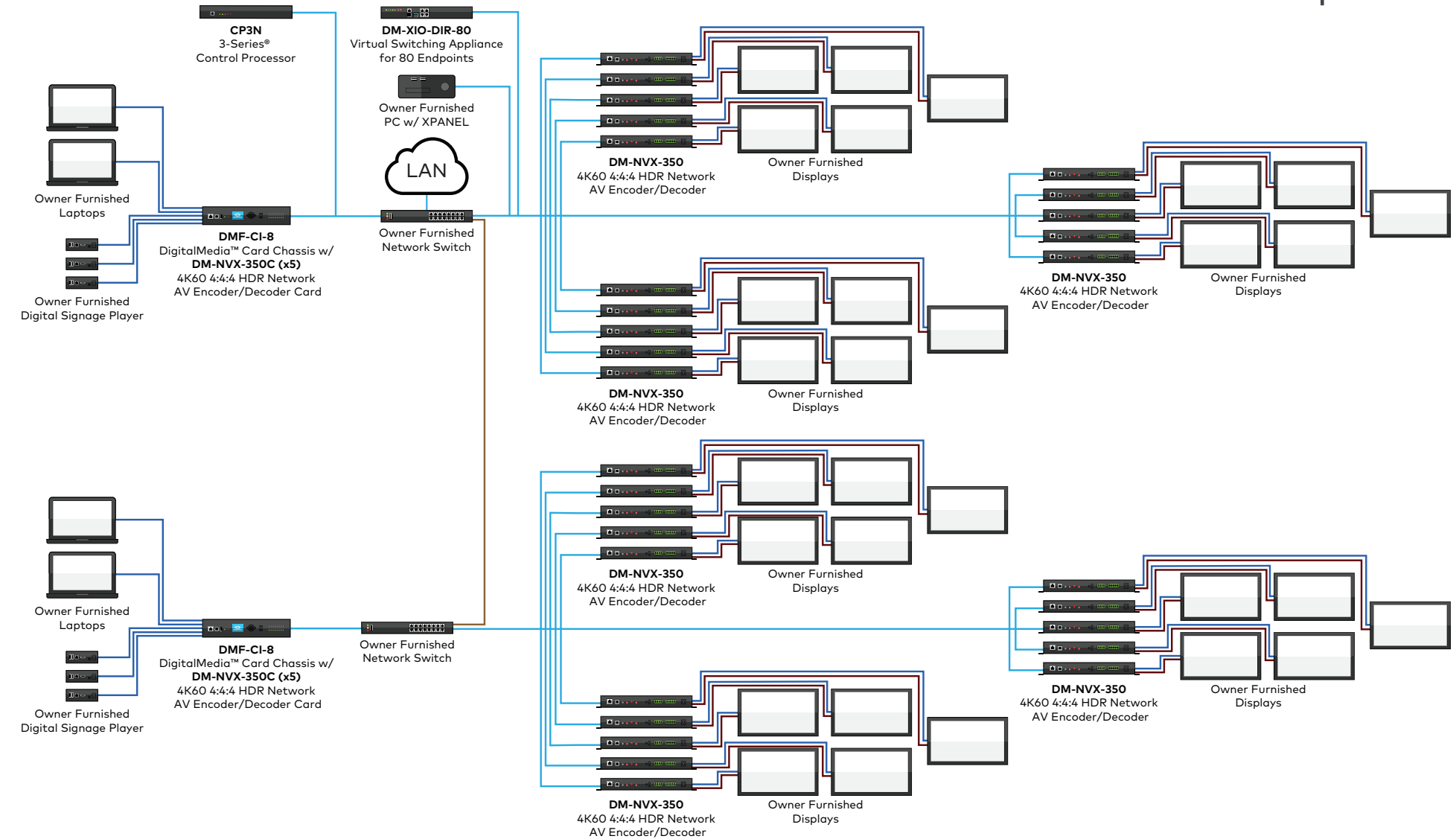

Retail Store Space



HOSPITALITY

Distribute flawless 4K60 4:4:4 HDR video over a 1Gb network throughout different hospitality spaces such as hotels and casinos. Magnificent video walls and displays powered by DM NVX® AV over IP technology with full customization showing different games and events playing simultaneously

- Stadiums
- Arenas
- Airports
- Hotels
- Casinos



USE CASE

- Flexible deployment across a casino building with AV over IP technology for when a video wall distribution is needed along with easy monitoring and management

BENEFITS

- Easily distribute content such as casino information, live sports and more using DM NVX® endpoints
- Display content from DM NVX endpoints to a video wall
- Control content from the reception desk using a commercial grade and purpose built TSW touch screen
- Configure, control and manage DM NVX endpoints using DM NVX Director™ Virtual Switching Appliance
- Fewer SKUs using DM NVX endpoints with a lower total cost of ownership
- Integrates seamlessly with owner furnished equipment such as PCs, digital signage players and cable boxes

CONCLUSION

- A casino featuring enterprise grade security down to the device level with AV over IP distribution with zero latency across the space with flexible content routing to any display

BOM EXAMPLE

QNTY	PRODUCT NAME
1	PRO3
2	TSW-1060
2	TSW-1060-TTK
59	DM-NVX-350
41	DM-NVX-350C
6	DMF-CI-8
1	DM-XIO-DIR-160

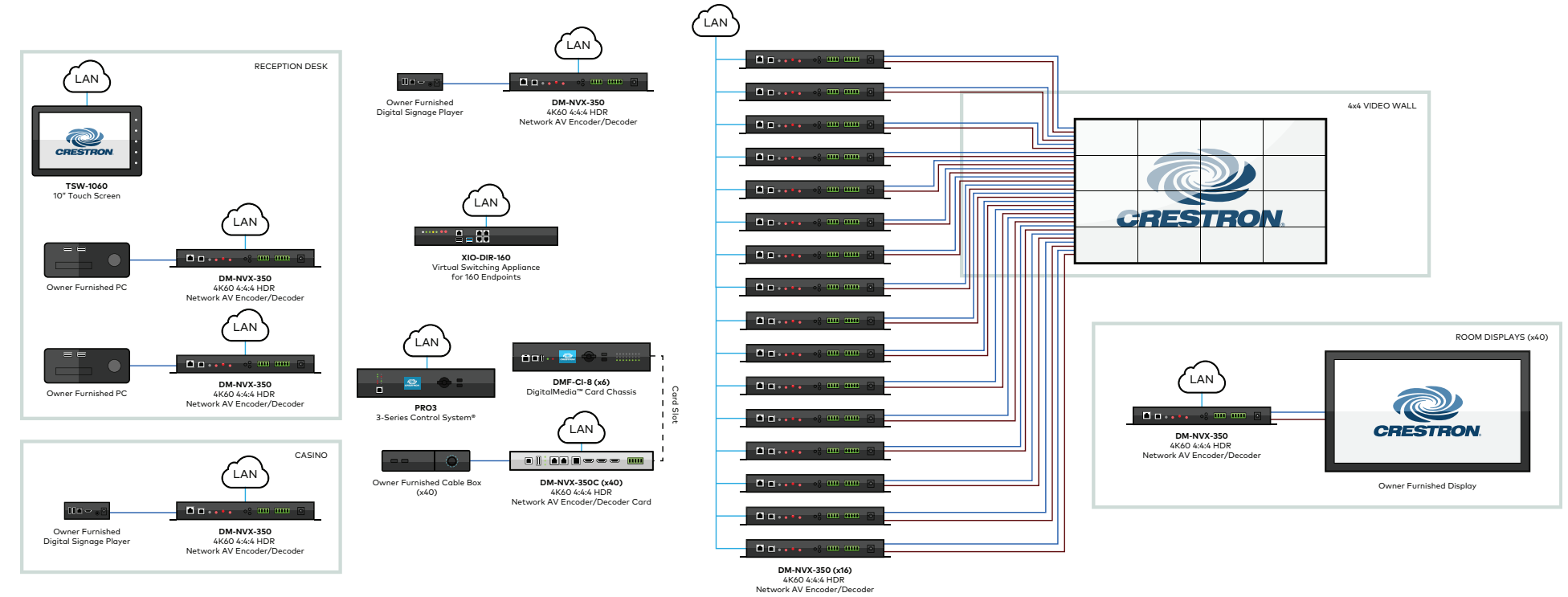

Key: ● Cat5/6 ● HDMI® Cables ● RS-232

Contact us for more information | crestron.com | 855.263.8754

World Headquarters

15 Volvo Drive
Rockleigh, NJ 07647
800.237.2041
201.767.3400
crestron.com

Latin America

Blvd. Manuel Avila Camacho 37-1A
Col. Lomas de Chapultepec
CP 11560
México
+52 (55) 9159.5900
+ (305) 290.4978
crestron.com.mx

Crestron Europe B.V.

Oude Keerbergsebaan 2
B-2820
Rijmenam
Belgium
+32.15.50.99.50
crestron.com

Australia

Level 5
15 Help Street
Chatswood NSW 2067
Australia
+61.1800.555.040
ANZHQ@crestron.com
crestron.com

New Zealand

Unit 18
144-160 Beaumont Street
Westhaven, Auckland 1010
New Zealand
+64.800.273.787
ANZHQ@crestron.com
crestron.com

Israel

14 Hata'as Street
Kfar Saba, 4442514
Israel
+972.9.7685556
crestron.co.il

India

Unit 101 & 102 RMZ Ecoworld
Campus 6B Sarjapur Marathalli
Outer Ring Road
Bangalore 560103
1.800.3005.8822
INDIAsalessupport@crestron.com
crestron.com

NE Asia

Suite 3101-02, 31/F Oxford House,
Taikoo Place 979 Kings Road
Hong Kong
+852 800 969 996
NEAsalessupport@crestron.com
crestron.com

China

487 Tian Lin Road Gems Park
Block 25 Xu Hui District
P.R.C. Shanghai 200233
Toll Free Phone: 400.880.9700

SE Asia

31 Kaki Bukit Road 3
#01-04 & #01-05
Techlink
Singapore 417818
+65.6394.9380
crestron.com

Japan

1736-3 Higashitsuda-Cho
Matsue City 690-0011
Japan
+81.852.60.5185
crestronjapan.com



All brand names, product names, and trademarks are the property of their respective owners. Certain trademarks, registered trademarks, and trade names may be used in this document to refer to either the entities claiming the marks and names or their products. Crestron disclaims any proprietary interest in the marks and names of others. Crestron is not responsible for errors in typography or photography. ©2020 Crestron Electronics, Inc.