

Crestron **TPMC-12L**
Isys[®] 12" Wall Mount Touch Screen

Operations Guide



This document was prepared and written by the Technical Documentation department at:



Crestron Electronics, Inc.
15 Volvo Drive
Rockleigh, NJ 07647
1-888-CRESTRON

Regulatory Compliance

As of the date of manufacture, the TPMC-12L has been tested and found to comply with specifications for CE marking and standards per EMC and Radiocommunications Compliance Labelling.



Federal Communications Commission (FCC) Compliance Statement

This device complies with part 15 of the FCC Rules. Operation is subject to the following conditions:
(1) This device may not cause harmful interference and (2) this device must accept any interference received, including interference that may cause undesired operation.

CAUTION: Changes or modifications not expressly approved by the manufacturer responsible for compliance could void the user's authority to operate the equipment.

NOTE: This equipment has been tested and found to comply with the limits for a Class B digital device, pursuant to part 15 of the FCC Rules. These limits are designed to provide reasonable protection against harmful interference in a residential installation. This equipment generates, uses and can radiate radio frequency energy and, if not installed and used in accordance with the instructions, may cause harmful interference to radio communications. However, there is no guarantee that interference will not occur in a particular installation. If this equipment does cause harmful interference to radio or television reception, which can be determined by turning the equipment off and on, the user is encouraged to try to correct the interference by one or more of the following measures:

- Reorient or relocate the receiving antenna
- Increase the separation between the equipment and receiver
- Connect the equipment into an outlet on a circuit different from that to which the receiver is connected
- Consult the dealer or an experienced radio/TV technician for help

Industry Canada (IC) Compliance Statement

This Class B digital apparatus complies with Canadian ICES-003.

Cet appareil numérique de la classe B est conforme à la norme NMB-003 du Canada.

Crestron, the Crestron logo, CresCAT, Cresnet, Crestron e-Control, Crestron Home, Crestron Toolbox, Crestron VisionTools, Isys, MediaMarker, QuickMedia, SystemBuilder and VT Pro-e are either trademarks or registered trademarks of Crestron Electronics, Inc. in the United States and/or other countries. Adobe, Acrobat and Flash are either trademarks or registered trademarks of Adobe Systems Incorporated in the United States and/or other countries. Java is either a trademark or registered trademark of Oracle America, Inc. in the United States and/or other countries. Microsoft, Excel, Internet Explorer, NetMeeting, PowerPoint, XP, Windows and Windows Media are either trademarks or registered trademarks of Microsoft Corporation in the United States and/or other countries. RealPlayer is either a trademark or registered trademark of RealNetworks, Inc. in the United States and/or other countries. Other trademarks and trade names may be used in this document to refer to either the entities claiming the marks and names or their products. Crestron disclaims any proprietary interest in the marks and names of others. All brand names, product names and trademarks are the property of their respective owners.

©2011 Crestron Electronics, Inc.

Contents

Isys[®] 12" Wall Mount Touch Screen: TPMC-12L	1
Introduction	1
Features and Functions	1
Specifications	4
Physical Description	7
Setup	13
Network Wiring	13
CAT5 Wiring	13
QuickMedia Wiring	13
Identity Code	15
Configuring the Touch Screen	15
Mounting Options	39
Hardware Hookup	41
Recommended Cleaning	43
Programming Software	44
Earliest Version Software Requirements for the PC	44
Programming with Crestron SystemBuilder	44
Programming with SIMPL Windows	44
Programming with VisionTools	47
Embedded Applications	51
Defaults for Embedded Windows Applications	52
Programming Embedded Windows Applications	53
Uploading and Upgrading	55
Establishing Communication	55
Programs, Projects and Firmware	56
Program Checks	56
Restore	56
Operation	57
MediaMarker	57
Security Infrastructure	57
Problem Solving	59
Troubleshooting	59
Check Network Wiring	60
Reference Documents	61
Further Inquiries	62
Future Updates	62
Return and Warranty Policies	63
Merchandise Returns / Repair Service	63
Crestron Limited Warranty	63
Microsoft [®] Windows XP [®] Embedded End User License Agreement	64

Isys[®] 12" Wall Mount Touch Screen: TPMC-12L

Introduction

The Crestron[®] TPMC-12L delivers a stylish and powerful touch screen control solution, featuring blazingly fast performance and native capabilities for browsing the Internet, streaming multimedia, intercom and more. A brilliant 12" active matrix SVGA display, 24-bit color depth and 8-bit alpha channel transparency combine to produce stunning 3D graphics using DNav dynamic menu objects, dynamic graphics and text, animations, multimode objects, full motion or streaming video, all with astonishing speed.

Features and Functions

- 12" active matrix touch screen display
- 24-bit touch screen graphics | 800 x 600 resolution
- DNav dynamic menu objects
- Full motion video with gamma correction
- Interactive annotation capability
- Windows[®] XP Embedded operating system
- Onboard PC applications for Web browsing, streaming media, conferencing, VoIP and remote computer access
- Multi-format streaming video and audio
- Direct screen-to-screen intercom over IP
- WAV file audio feedback
- Built-in amplified speaker system and microphone
- QuickMedia[®]* and Crestron Home[®] CAT5 connectivity
- High speed Ethernet and Cresnet[®] communications
- Rear panel USB ports and memory card slot
- Backlit "hard key" push buttons
- Wall, lectern and rack mounting options
- Available in black or white

* QuickMedia[®] implementation in this product supports standard definition video only; does not support HDTV or high resolution RGB.

Touch Screen Control

Crestron touch screens offer an ideal user interface for multimedia presentation, home automation and much more, providing a wide open canvas for the creation of custom control screens tailored to the needs of the end user. Touch screens do away with piles of remote controls, cryptic control panels and cluttered wall switches, simultaneously expanding and simplifying control over a broad range of complex devices and systems.

Embedded PC

The power of Isys i/O is in its embedded PC engine, combining rock solid touch screen performance with built-in Windows Media[®] Player and RealPlayer[®], Internet Explorer[®], Adobe[®] Acrobat[®] Reader and Microsoft[®] Word, Excel[®] and PowerPoint[®] document viewers. While simultaneously controlling your home, boardroom or lecture hall, the TPMC-12L provides everything needed for enjoying online music and movies, viewing Web pages and accessing most types of digital media without necessitating a separate computer.

VNC Viewer support delivers enhanced cross-platform interaction with remote computers over the network or Internet, allowing access and control of desktop applications with live presentation capability.

Built on the Windows[®] XP Embedded operating system, the TPMC-12L delivers a powerful and secure platform for touch screen control with integrated PC capabilities. Programmatic control erases the lines between control system and PC, allowing programmers to customize each application's behavior within the touch screen environment to create a truly powerful and user-friendly interface.

Integrated Video

For presentation preview, surveillance or pure entertainment, the TPMC-12L provides multiple ways to view video signals from security cameras, movies and other sources right on the touch screen. Video images can be displayed full screen as well as in a fully scalable window. High quality, full motion video is supported via a direct wire connection from an external AV source. Streaming video is also supported in a variety of formats over the LAN connection, enabling access to everything from online streaming videos to personal media servers to live Web cameras and servers like the Crestron CEN-NVS100 (sold separately).

Interactive Annotation

Built-in annotation capability allows presenters to write or draw over video images right on the touch screen using a finger or stylus. Remote annotation capability allows multiple touch screen users to draw over the same image, supporting interactive annotation between several participants in a courtroom, classroom or similar environment.

High Quality Audio

Built-in amplified speakers provide clear audio for external AV sources, streaming media and internal PC applications and enable two-way intercom and VoIP communications in combination with the integrated microphone. New Crestron IP intercom capability facilitates direct screen-to-screen intercom and monitoring right over the LAN without requiring additional AV wiring. Customized WAV files can be loaded on the touch screen to add dimension to the touch screen graphics with personalized sounds, button feedback and voice prompts.

Crestron Home[®] CAT5 AV

Connecting audio and video sources to the TPMC-12L is facilitated using inexpensive CAT5 wire, enabling direct connection to Crestron's popular CAT5 balanced audio and video distribution switchers. A single video input port accepts signals from composite, S-video and standard definition component sources over wiring distances of up to 750 feet (229 meters). A bidirectional audio port receives stereo program audio and intercom signals and outputs audio from the internal PC and microphone. To facilitate the connection of conventional video and audio devices, an external interface module (TPMC-CH-IMC) is included.

QuickMedia^{®*}

The TPMC-12L is also equipped with a single QuickMedia input port. Through QuickMedia (QM), the TPMC-12L interfaces directly with Crestron's QM-based MediaManager products using a single CAT5e type cable. Over wiring distances of up to 450 feet (137 meters), the QM input port accepts video signals from composite, S-video and standard definition component sources along with discrete audio signals from one stereo program source and up to two microphones.

High Speed Connectivity

Both Cresnet[®] and high speed Ethernet are standard on the TPMC-12L, providing for easy network integration and seamless communications with Crestron control systems, media servers and computers. Two USB 2.0 ports are also included on the rear panel to support a mouse and keyboard and external storage devices.

Versatile Flush Mount Design

The TPMC-12L is designed for easy flush mount installation in a wall, lectern or similar flat surface. A variety of mounting accessories is offered including optional back box and 19" rack mount kit. Four backlit push buttons are also provided, allowing for quick access to commonly used functions.

* QuickMedia implementation in this product supports standard definition video only; does not support HDTV or high resolution RGB.

Specifications

Specifications for the TPMC-12L are listed in the following table.

TPMC-12L Specifications

SPECIFICATION	DETAILS
Touch Screen Display	
Display Type	TFT active matrix color LCD
Size	12 inch (30.5 cm) diagonal
Aspect Ratio	4:3 SVGA
Resolution	800 x 600 pixels
Brightness	400 nits
Contrast	600:1
Color Depth	18-bit, 256k colors
Illumination	Backlit fluorescent
Viewing Angle	±80° horizontal, +80°/-60° vertical
Touch Screen	Resistive membrane
Memory	
SRDAM	512 MB
Flash	2 GB
Memory Card	Expandable up to 4 GB using MMC compatible card (not included)
Maximum Project Size	120 MB using external flash
Operating System	Microsoft Windows XP Embedded
Graphic Engine	24 bit non-palette graphics + 8 bit alpha channel translucency, 16.7 million colors, multi-mode objects, DNav dynamic menu objects, dynamic graphics ¹ , PNG translucency, full-motion (60 fps) animation, transition effects, color key video windowing, remote annotation.
Embedded Software Applications ²	Microsoft Internet Explorer with Adobe Flash [®] plug-in, Windows Media Player, RealPlayer, Crestron MJPEG Viewer, Crestron IP Intercom, NetMeeting [®] , Remote Desktop, VNC Viewer ³ , Java™ Runtime, Crestron MediaMarker™ Notebook, Crestron Keyboard, Adobe Acrobat Reader, WordPad, MS Word Viewer 2007, Excel Viewer 2007, PowerPoint Viewer 2007.
Ethernet	10BASE-T/100BASE-TX/1000BASE-T, auto-switching, auto-negotiating, autodiscovery, full/half duplex TCP/IP, UDP/IP, CIP, DHCP Unit ships with DHCP enabled

(Continued on following page)

TPMC-12L Specifications (Continued)

SPECIFICATION	DETAILS
Video	
Signal Types	Auto-detecting composite, S-video or component
Formats	NTSC 480i or PAL 576i
Color Depth	24-bit, 16.7M colors
Features	Single window scalable to full screen, input switching between QM and VIDEO inputs, gamma correction, line doubling
Streaming/File Formats	MPEG4 and MJPEG via Crestron MJPEG Viewer, plus all formats supported by the embedded media player applications ²
Audio	
Hardware Features	Built-in microphone and amplified speakers, internal volume control and audio mixer
Streaming/File formats	All formats supported by the embedded media player application ²
Audio Feedback (WAV)	8 and 16-bit PCM, mono and stereo, 8 - 44.1 kHz sampling rates
D-A Conversion (QM only)	24-bit, 48 kHz
Amplification	Mono, 5 Watts x 2
Power Requirements	
Cresnet Power Usage	37 Watts (1.54 Amps @ 24 Volts DC)
Default Net ID ⁴	03
Minimum 2-Series Control System Update File ^{5,6}	Version 4.001.1012 or later
Environmental	
Temperature	41° to 113° F (5° to 45° C)
Humidity	10% to 90% RH (non-condensing)
Heat Dissipation	126 BTU/Hr
Enclosure	
Construction	Metal, flush mountable, 8U 19" rack mountable (all mounting kits sold separately)
Front Bezel	Injection molded plastic; black with silver or white with gray accent
Dimensions	
Height	11.80 in (300 mm)
Width	13.61 in (346 mm)
Depth	3.81 in (97 mm)
Weight	8.5 lbs (3.9 kg)
Available Models	
TPMC-12LB	Isys 12" Wall Mount Touch Screen, Black
TPMC-12LW	Isys 12" Wall Mount Touch Screen, White

(Continued on following page)

TPMC-12L Specifications (Continued)

SPECIFICATION	DETAILS
Included Accessories TPMC-CH-IMC	CAT5 Balanced AV Interface Module + 15 ft triamese cable Refer to the latest revision of the TPMC-CH-IMC Operations Guide (Doc. 6345) for more information
Available Accessories BB-12L CEN-NVS100 CresCAT®D CresCAT-IM CresCAT-QM MMK-12L PMK-12L QM-TX RMK-12L TMK-12L TPMC-CH-IMW TPS/TPMC-CBL-T WMKM-12L WMKT-12L	Pre-Construction Wall Mount Back Box Network Video Streamer Crestron Home® CAT5 Balanced AV Cable iMedia cable QuickMedia Cable Mud Ring Pre-Construction Wall Mount Kit QuickMedia Transmitter Rack Mount Kit Trim Ring CAT5 Balanced AV Interface Wall Plate Triamese Interface Cables Post-Construction Wall Mount Kit with Mud Ring Lectern or Post-Construction Wall Mount Kit with Trim Ring

1. By design, the touch screen will not load dynamic graphics if they are located on a password protected FTP or HTTP server.
2. Contact Crestron for a current list of compatible devices and embedded applications. To ensure reliable performance, new device drivers and applications are available only from Crestron through firmware updates.
3. The supported VNC viewer is UltraVNC version 1.0.2. Other VNC viewers may work but are not guaranteed.
4. Refer to "Identity Code" on page 15 for details.
5. The latest software versions can be obtained from the Crestron Web site. Refer to the NOTE following these footnotes.
6. Crestron 2-Series control systems include the AV2 and PRO2. Consult the latest Crestron Product Catalog for a complete list of 2-Series control systems.

NOTE: Crestron software and any files on the Web site are for authorized Crestron dealers and Crestron Authorized Independent Programmers (CAIP) only. New users may be required to register to obtain access to certain areas of the site (including the FTP site).

Physical Description

This section provides information on the connections, controls and indicators available on your TPMC-12L.

TPMC-12L Physical View



TPMC-12L Overall Dimensions (Front, Side and Bottom Views)

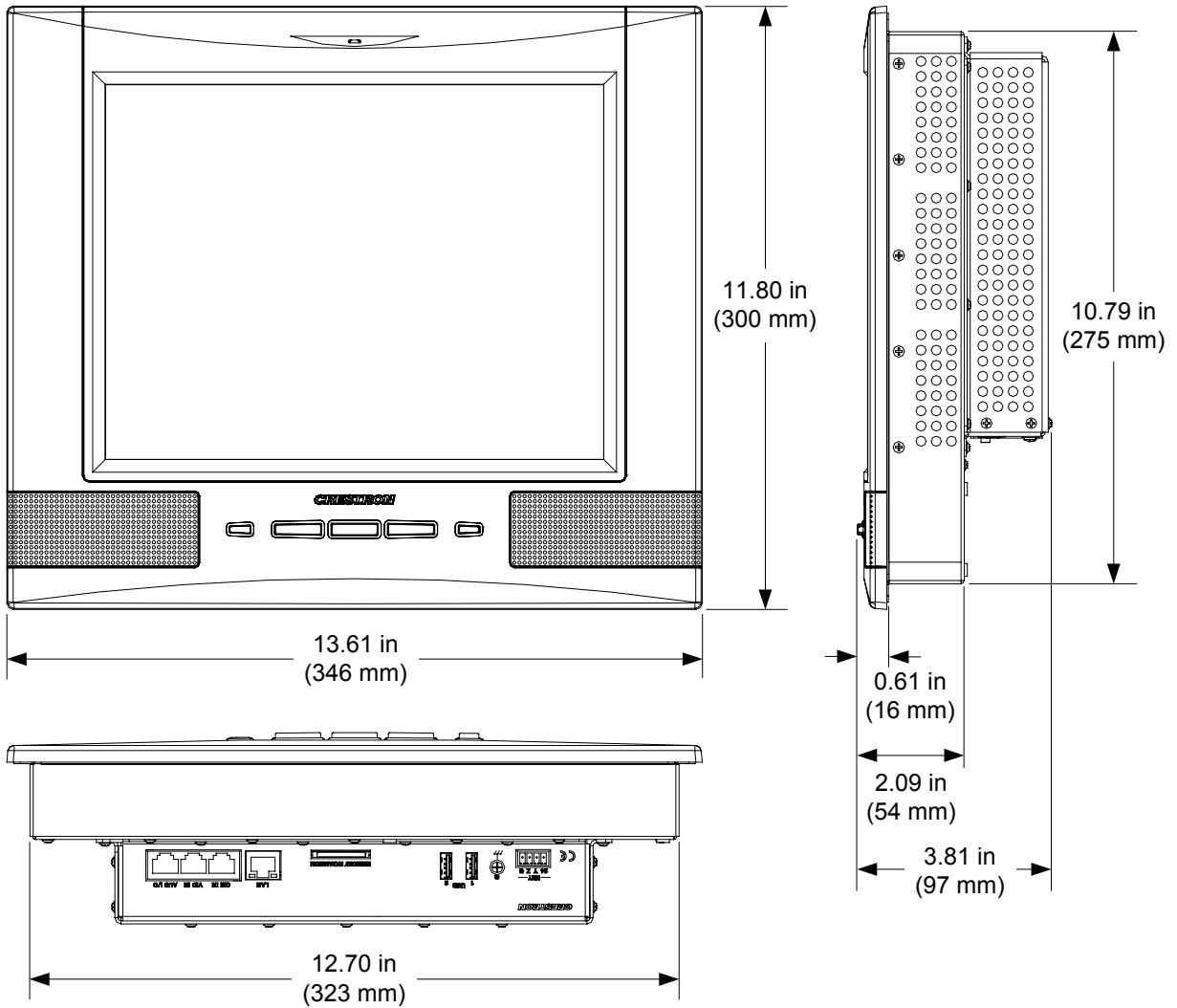

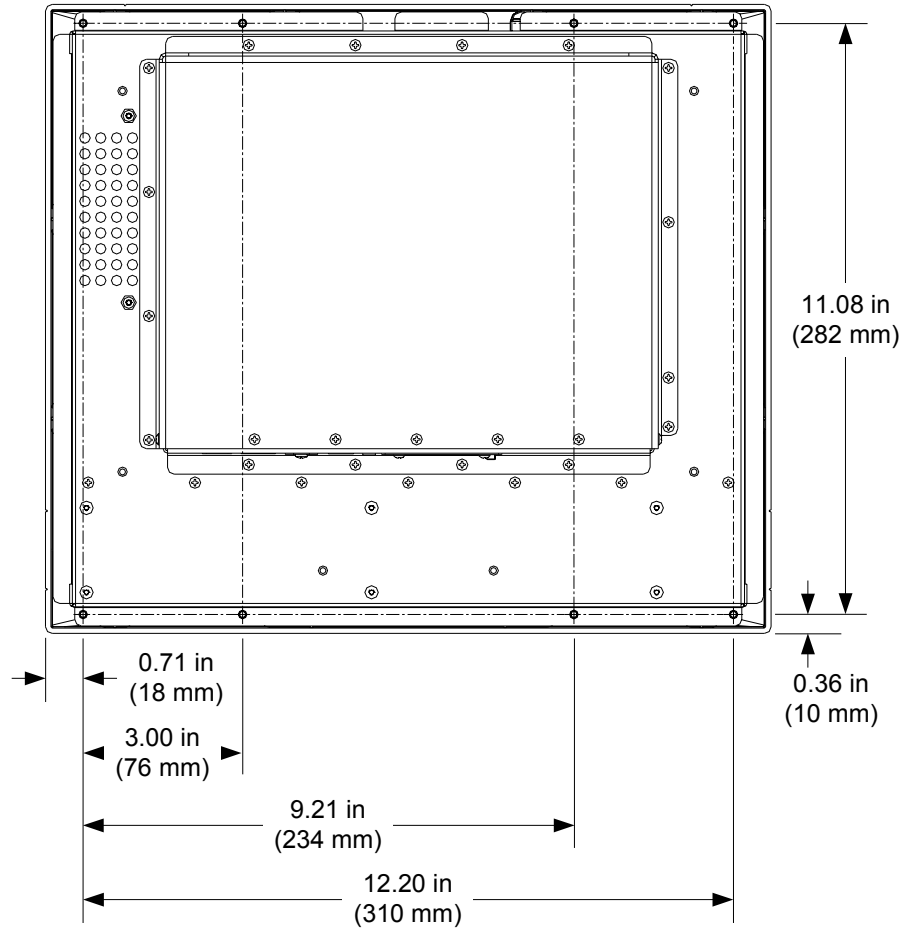

TPMC-12L Overall Dimensions (Rear View)

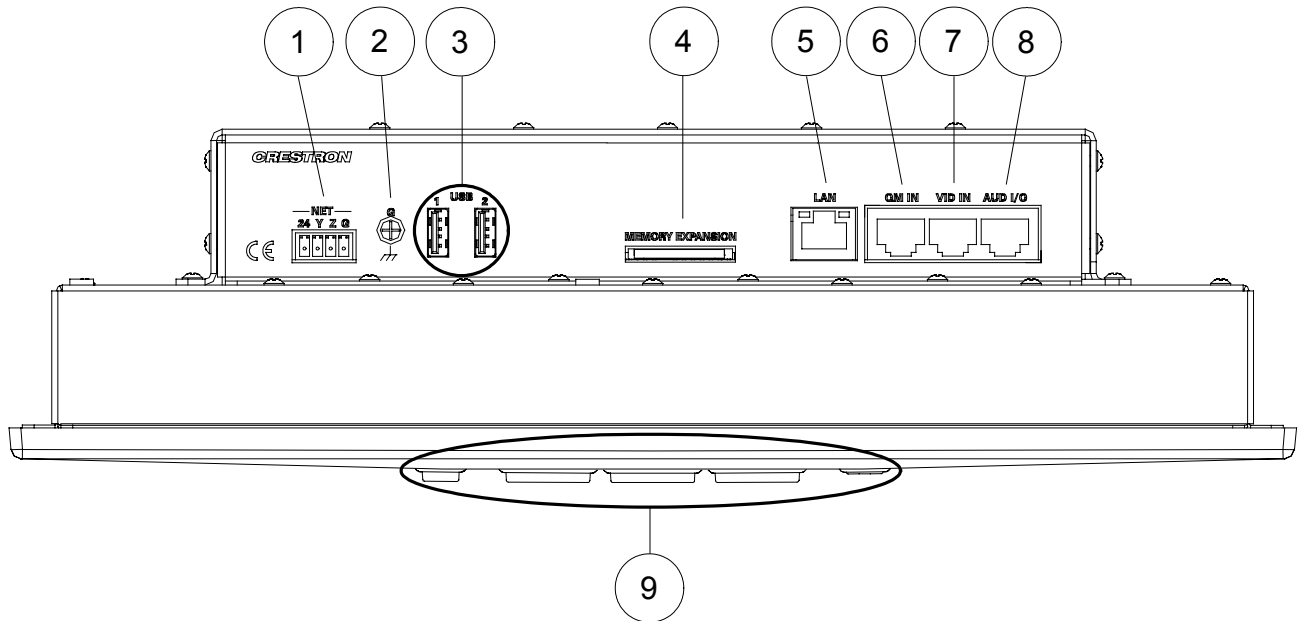

TPMC-12L Connectors



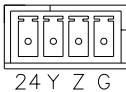

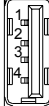
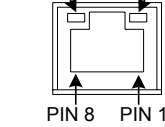
Connectors, Controls & Indicators

#	CONNECTORS ¹ , CONTROLS & INDICATORS	DESCRIPTION																				
1	<p>NET</p> 	<p>(1) 4-pin 3.5 mm detachable terminal block Connects to Cresnet control network or TPMC-CH-IMC interface module (included) via 15 foot (4.6 meter) "triamese" cable provided</p> <p>24: Power (24 Volts DC) Y: Data Z: Data G: Ground</p>																				
2	<p>GROUND</p> 	<p>(1) 6-32 screw, chassis ground lug</p>																				
3	<p>USB</p> 	<p>(2) USB Type A female USB 2.0 ports for USB keyboard, mouse and storage devices²</p>																				
4	<p>MEMORY EXPANSION</p>	<p>(1) MMC compatible card slot Accepts Multimedia Memory Cards (MMC) up to 4 GB for memory expansion²</p>																				
5	<p>LAN</p> <p>YELLOW/ GREEN LED GREEN LED</p> 	<p>(1) 8-wire RJ-45 with two LED indicators 10BASE-T/100BASE-TX/1000BASE-T Ethernet port</p> <p>Left yellow LED indicates 10 Mbps link status Left green LED indicates 100 Mbps link status Right green LED indicates 1000 Mbps link status</p> <p>For all LEDs, blinking = active, on = no activity, off = no link</p> <table border="1"> <thead> <tr> <th>PIN</th> <th>SIGNAL</th> <th>PIN</th> <th>SIGNAL</th> </tr> </thead> <tbody> <tr> <td>1</td> <td>A +</td> <td>5</td> <td>C -</td> </tr> <tr> <td>2</td> <td>A -</td> <td>6</td> <td>B -</td> </tr> <tr> <td>3</td> <td>B +</td> <td>7</td> <td>D +</td> </tr> <tr> <td>4</td> <td>C +</td> <td>8</td> <td>D -</td> </tr> </tbody> </table>	PIN	SIGNAL	PIN	SIGNAL	1	A +	5	C -	2	A -	6	B -	3	B +	7	D +	4	C +	8	D -
PIN	SIGNAL	PIN	SIGNAL																			
1	A +	5	C -																			
2	A -	6	B -																			
3	B +	7	D +																			
4	C +	8	D -																			

(Continued on following page)

Connectors, Controls & Indicators (Continued)

#	CONNECTORS ¹ , CONTROLS & INDICATORS	DESCRIPTION
6	QM IN ^{3,4} 	(1) 8-wire RJ-45 female, QuickMedia input port Signal types: Auto-detecting component (YPbPr), S-video (Y/C) or composite video with stereo program audio and (2) mic channels Video formats: NTSC 480i or PAL 576i; Connects to QM output port of a QM-TX or other QuickMedia device via CresCAT-QM or CresCAT-IM cable Maximum cable length: 450 feet (137 meters) (aggregate distance from QM origination)
7	VIDEO IN ^{5,6} 	(1) 8-wire RJ-45 female, CAT5 balanced video input port Signal types: Auto-detecting component (YPbPr), S-video (Y/C) or composite Video formats: NTSC 480i or PAL 576i; Input impedance: 100 Ω balanced Connects to any Crestron CAT5 balanced video source via CresCAT-D cable or TPMC-CH-IMC interface module (included) via 15 foot (4.6 meter) "triamese" cable provided Maximum cable length: 500 feet (152 meters) for component, 750 feet (229 meters) for composite/S-video
8	AUDIO I/O ^{5,7} 	(1) 8-wire RJ-45 female, bidirectional CAT5 balanced audio port Signal type: receives (1) balanced stereo audio signal and transmits (1) balanced stereo audio signal from internal microphone Maximum input level: 4 V _{rms} Maximum output level: 2 V _{rms} Input/output impedance: 600 Ω Connects to any other Crestron CAT5 balanced audio port via CresCAT-D cable or TPMC-CH-IMC interface module (included) via 15 foot (4.6 meter) "triamese" cable provided Maximum cable length: 1000 feet (305 meters)
9	BUTTONS ⁸	(4) Backlit "hard key" buttons, programmable (1) Backlit hard reset button, reboots the touch screen

1. An interface connector for the **NET** port is provided with the unit.
2. Contact Crestron for a current list of compatible devices and embedded applications. To ensure reliable performance, new device drivers and applications are available only from Crestron through firmware updates.
3. QuickMedia implementation in this product supports standard definition video only; does not support HDTV or high resolution RGB.

- The eight-pin RJ-45 QuickMedia transport port accepts CAT5E/CAT6 carrying audio, video and microphone signals. The QM input port conforms to the 568B wiring standard. Refer to the following table for connector pinouts.

RJ-45 PIN NUMBER	WIRE COLORS (EIA 568B)	QM ASSIGNMENT: COMPOSITE, S-VIDEO, COMPONENT AND AUDIO
1	WHITE/ORANGE	- CHROMINANCE (- P _r)
2	ORANGE	+ CHROMINANCE (+ P _r)
3	WHITE/GREEN	- LUMINANCE (- Y)
4	BLUE	+ DIGITAL AUDIO
5	WHITE/BLUE	- DIGITAL AUDIO
6	GREEN	+ LUMINANCE (+ Y)
7	WHITE/BROWN	- COMPOSITE (- P _b)
8	BROWN	+ COMPOSITE (+ P _b)

- Use only the TPMC-CH-IMC Interface Module when connecting this port. Use of other “IMC” products could damage the touch screen.
- This eight-pin RJ-45 port provides connectivity to the CNX-PVID or the TPMC-CH-IMC Interface Module. This port provides component, composite or S-video balanced input to the touch screen over CAT5 wiring. Refer to the following table for connector pinouts.

PIN	WIRE COLORS (568B)	COMPOSITE	S-VIDEO	COMPONENT
1	WHITE/ORANGE	+ Composite	+ Luminance	+ Y
2	ORANGE	- Composite	- Luminance	- Y
3	WHITE/GREEN	N/A	+ Chrominance	+ P _b
4	BLUE	N/A	N/A	+ P _r
5	WHITE/BLUE	N/A	N/A	- P _r
6	GREEN	N/A	- Chrominance	- P _b
7	WHITE/BROWN	N/A	N/A	N/A
8	BROWN	N/A	N/A	N/A

- This eight-pin RJ-45 port provides connectivity to the CNX-BIPAD or the TPMC-CH-IMC Interface Module. This port uses CAT5 wiring and provides audio input to the touch screen and output from the touch screen’s built-in microphone. Refer to the following table for connector pinouts.

PIN	WIRE COLORS (568B)	AUDIO I/O
1	WHITE/ORANGE	+ Mic Left Out
2	ORANGE	- Mic Left Out
3	WHITE/GREEN	+ Mic Right Out
4	BLUE	+ Audio Left In
5	WHITE/BLUE	- Audio Left In
6	GREEN	- Mic Right Out
7	WHITE/BROWN	+ Audio Right In
8	BROWN	- Audio Right In

- Refer to “Push Button Programming” on page 50 for details.

Setup

Network Wiring

When wiring the Cresnet network, consider the following:

- Use Crestron Certified Wire.
- Use Crestron power supplies for Crestron equipment.
- Provide sufficient power to the system.

CAUTION: Insufficient power can lead to unpredictable results or damage to the equipment. Please use the Crestron Power Calculator to help calculate how much power is needed for the system (www.crestron.com/calculators).

For larger networks, use a Cresnet Hub/Repeater (CNXHUB) to maintain signal quality.

For more details, refer to “Check Network Wiring” which starts on page 60.

The TPMC-12L can also use high-speed Ethernet for communications between the device and a control system, computer, media server and other IP-based devices.

For information on connecting Ethernet devices in a Crestron system, refer to the latest version of the Crestron e-Control® Reference Guide (Doc. 6052), which is available from the Crestron Web site (www.crestron.com/manuals).

CAT5 Wiring

Category 5 (CAT5) wiring is a twisted pair cable designed for Ethernet networks. These networks operate at speeds of up to 100 Megabits per second (Mbps) using the 100BASE-T standard. Crestron takes advantage of this specification for a variety of audio and video applications.

When using a Crestron wiring solution, the CresCAT-IM (or D) wire can carry audio and video signals up to 500 feet (152 meters) (observe distance limitations based upon power consumption for the device in use).

For more information, refer to the latest version of the Crestron CAT5 Wiring Reference Guide (Doc. 6137), which is available from the Crestron Web site.

QuickMedia Wiring

The Crestron QuickMedia (QM) cable (sold under the name “CresCAT-QM”) contains one CAT5E cable and one Cresnet cable in Siamese jackets. Installation of any QM device is as simple as installing CresCAT-QM wires from the output of one device to the input of another. Installations are flexible, affordable and fast. For more information, refer to the latest revision of the Crestron MediaManager Applications Guide (Doc. 6244), which is available from the Crestron Web site.

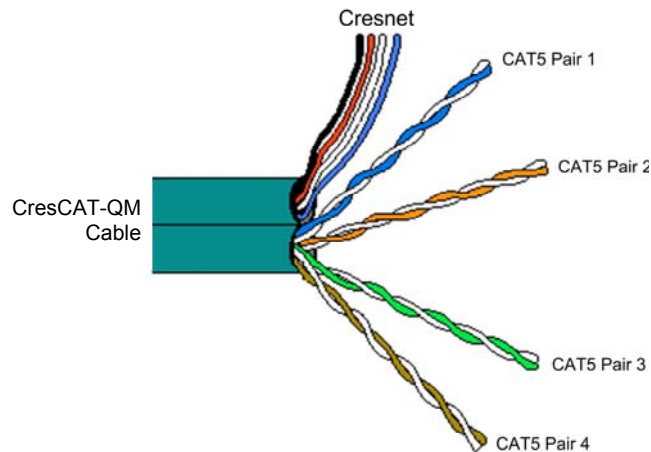
CresCAT-QM Cable

NOTE: Do not untwist the two wires in a single pair for more than 1/3-1/2" (8-12 mm) when making a connection. The twists are critical to canceling out interference between the wires.

The aggregate cable length of a signal path originating at a QM transmitter and terminating at a TPMC-12L must not exceed 450 feet (137 meters). Video signals may experience a loss of quality over very long lengths of cable. This phenomenon is due to the added resistance and capacitance of longer cable lengths and is not peculiar to either Crestron and/or QuickMedia systems. To ensure sufficient bandwidth, the maximum aggregate cable length should not exceed 450 feet. The use of lower-resolution signals may allow increased cable length but must be tested by the installer with the sources to be used. The QM pin assignment is based on the EIA/TIA 568B RJ-45 Jack standard.

NOTE: When transmitting S-video, luminance uses the green video pathway and chrominance uses the red video pathway. When transmitting composite video, the signal is carried on the blue video pathway.

NOTE: When using CresCAT-QM wiring, four additional wires are included for making Cresnet connections.

When connecting multiple QM devices, the route between a QM origination point (transmitter) and a QM endpoint (receiver) cannot have more than two midpoints (e.g. QM-MD7x2 or other QM switchers). Refer to the following diagram when configuring a QM network.

NOTE: The aggregate length from transmitter to receiver cannot have a delay skew of more than 22 ns.

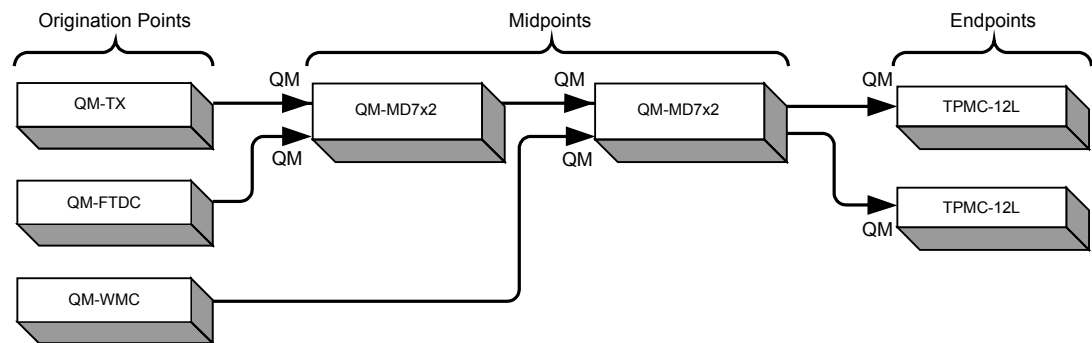
QM Network Topology**Identity Code****Net ID**

The Net ID of the TPMC-12L has been factory set to **03**. The Net IDs of multiple TPMC-12L devices in the same system must be unique. The Net ID is set using the internal setup menu (refer to “Cresnet” which starts on page 20). Net ID may also be set from a personal computer (PC) via Crestron Toolbox™ (refer to “Establishing Communication” on page 55).

When setting the Net ID, consider the following:

- The Net ID of each unit must match an ID code specified in the SIMPL Windows program.
- Each network device must have a unique Net ID.

For more details, refer to the Crestron Toolbox help file.

IP ID

The IP ID is set within the TPMC-12L’s table using Crestron Toolbox. For information on setting an IP table, refer to the Crestron Toolbox help file. The IP IDs of multiple TPMC-12L devices in the same system must be unique.

When setting the IP ID, consider the following:

- The IP ID of each unit must match an IP ID specified in the SIMPL Windows program.
- Each device using IP to communicate with a control system must have a unique IP ID.

Configuring the Touch Screen

NOTE: The only connection required to configure the touch screen is power (supplied via Cresnet). Refer to “Hardware Hookup” which starts on page 41 for details.

NOTE: When booting the TPMC-12L, the only USB devices supported are a keyboard or mouse. Having a USB drive or hub connected will interfere with proper booting of the touch screen.

The TPMC-12L is configured from the setup menu.

NOTE: If no project has been loaded or if an invalid project has been loaded, the touch screen defaults to the setup menu screen.

If a project is running, the setup menu can be accessed using one of two methods: USB keyboard or Crestron Toolbox.

Via USB Keyboard

1. Attach a USB keyboard (refer to “Hardware Hookup” which starts on page 41 for details).
2. Open the “Validate User Account Info” window (shown on the following page) by pressing **Ctrl+Alt+Shift** on the keyboard.

“Validate User Account Info” Window

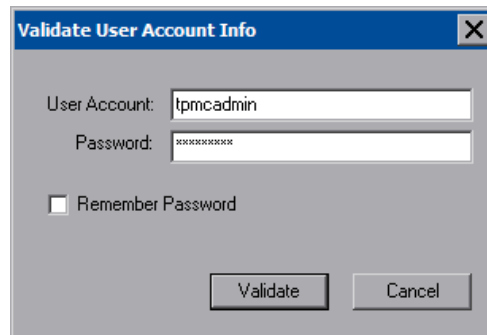

3. Enter the user account *tpmadmin*, and the password *tpmadmin* and touch **Validate**.

NOTE: The password is case sensitive. After logging in, the password can be changed from the “Security” window. Refer to “Security” which starts on page 18 for more information.

4. When the “Crestron Debug Output” window appears (shown in the following diagram), select **Project | Enter Setup Mode** to enter the setup menu (refer to “Setup Menu Details” on page 18).

“Crestron Debug Output” Window

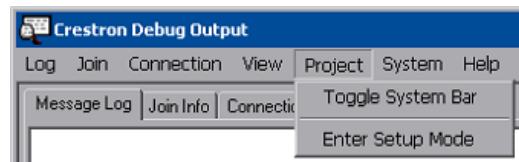

Via Crestron Toolbox

1. Establish communication with the touch screen (refer to “Establishing Communication” on page 55 for details).
2. From the Network Device Tree, right-click on the device, then select **Functions | Setup Mode....**

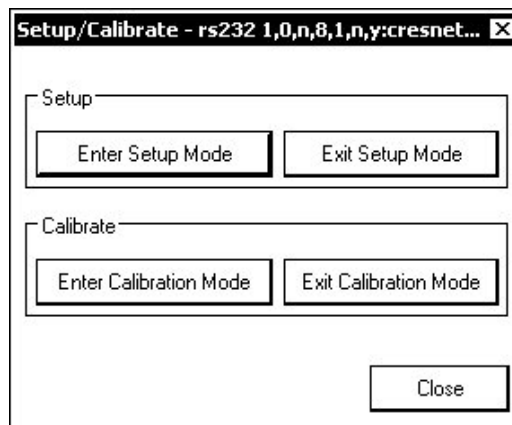
“Setup/Calibrate” Window

3. Select **Enter Setup Mode**. The setup menu will be displayed as shown in the illustration below.

NOTE: Select **Exit Setup Mode** to exit the setup menu.

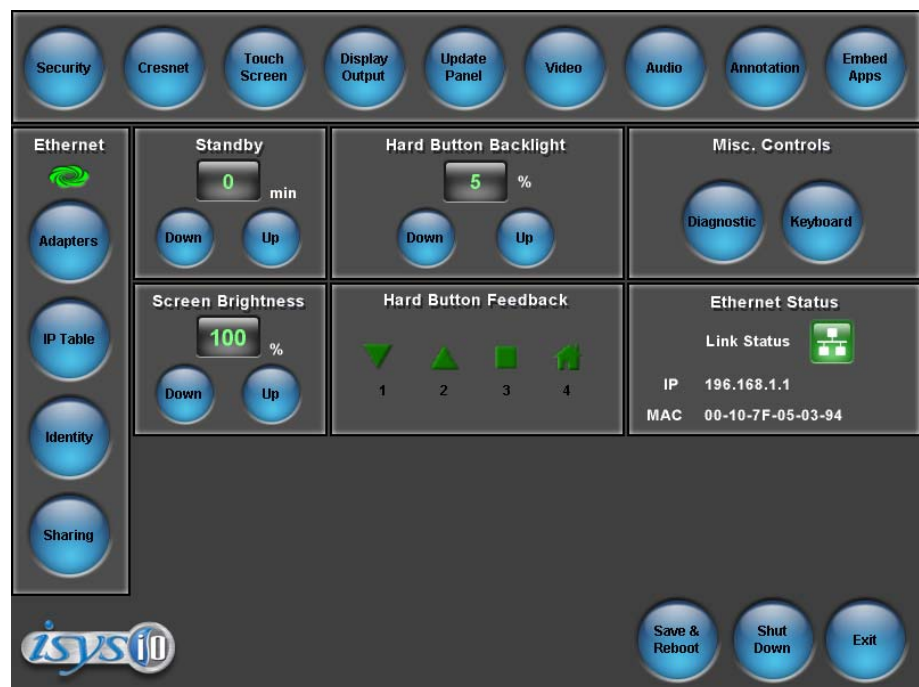
TPMC-12L Setup Menu

NOTE: Another way to enter the setup menu (after a project has been loaded) is to touch the screen during boot up when you see the “Preparing to Load Project” message. Maintain touch until after the countdown, when the message will change to “Loading Setup Screen”.

The setup menu provides access to all basic functions and parameters. It is divided into a top row of setup buttons and *Ethernet*, *Standby*, *Hard Button Backlight*, *Misc. Controls*, *Screen Brightness*, *Hard Button Feedback*, and *Ethernet Status* sections. There are also buttons for **Save & Reboot**, **Shut Down** and **Exit**.

NOTE: To allow the touch screen to upload projects, standby is disabled until approximately five minutes after the project is loaded.

To exit the setup menu and return to the program, touch **Exit**, located at the bottom of the setup menu. To save any changes and reboot the touch screen, touch **Save & Reboot**, located at the bottom of the setup menu. Use the **Shut Down** button to turn off the touch screen.

Setup Menu Details

The setup menu allows configuration of the touch screen's settings for security, Cresnet ID, touch screen calibration, display, runtime project, video, audio, annotation, embedded applications, diagnostics and hard button programming. The setup menu also has a button that will toggle the on-screen keyboard on and off.

NOTE: When in *Annotation* mode, the setup menu will still be available but all setup windows will be disabled (i.e. you will not be able to bring up any setup window via a digital join). For more information about *Annotation* mode, refer to "About Annotation Mode" in the Crestron VisionTools® (VT Pro-e®) Help file.

Security

The **Security** button opens the "Security Setup" window, which allows the user to change the username and password of the system account, setup and close network connections, setup a proxy server, close network connections and clear Internet browser temporary files, history and cookies.

NOTE: To use the on-screen keyboard for security settings, touch **Keyboard** on the startup menu before touching **Security**.

"Security Setup" Window

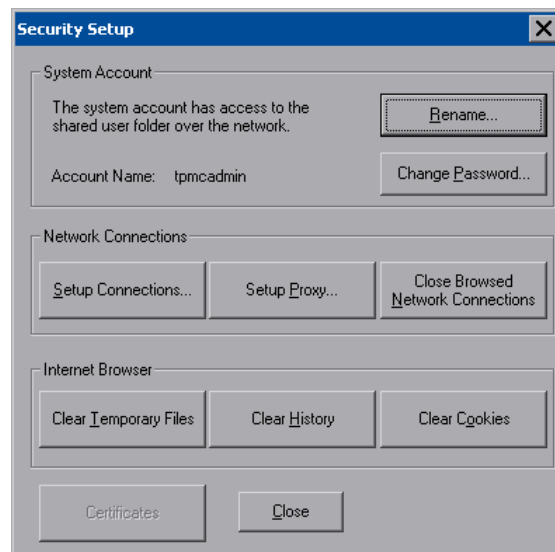

Touch **Setup Connections...** to open the "Network Connections" window. This window is used to map to a network drive. A mapped network drive permits easy access to embedded application files (Word, Excel, PowerPoint, MediaMarker, etc.)

and provides a location to save files. To further customize the installation, network drives containing compiled touch screen project files can also be mapped.

“Network Connections” Window

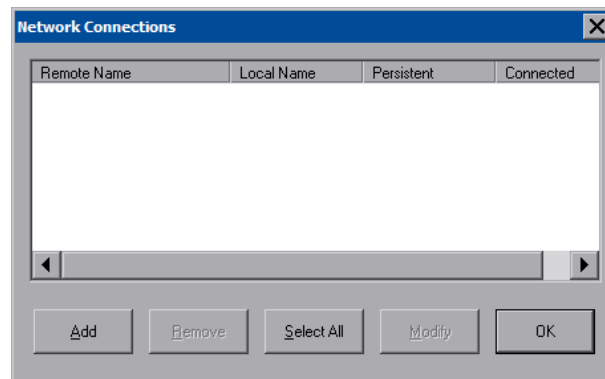

To add a new network connection, touch **Add...**

“Configure Network Connection” Window

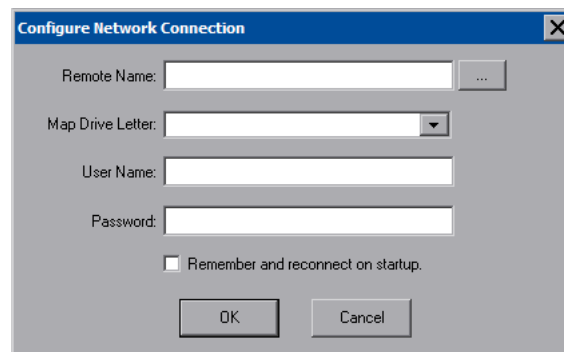

To add a network drive, perform the following procedure:

1. Touch to browse for the new network connection. If the remote shareable folder name does not appear on the list, it can be entered manually in the *Remote Name* field, using the following format:

```
\\Remote host name\Shareable folder name
```
2. Map this connection by selecting a drive letter from the *Map Drive Letter* drop box.
3. Enter a user name and password.
4. Touch the *Remember and reconnect on startup* checkbox if so desired.
5. Touch **OK** to enable the new network connection and return to the “Network Connections” window.

Once all changes to network connections have been completed, touch **OK** to return to the “Security Setup” window.

Touch **Setup Proxy...** to open the “Setup Proxy” window. This window is used to point to a proxy server for Internet access. A proxy server acts as an intermediary between your internal network (intranet) and the Internet, retrieving files from remote Web servers.

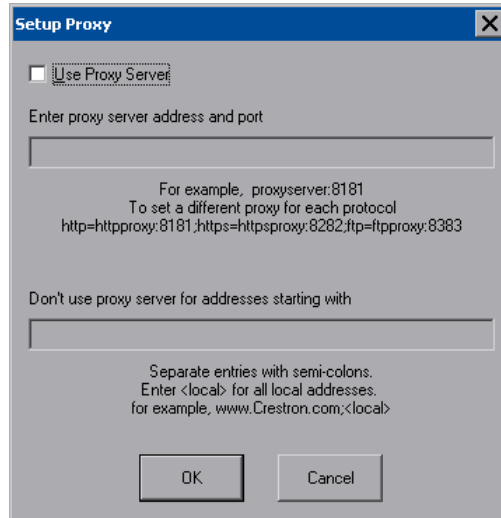
“Setup Proxy” Window

To setup a proxy server, select *Use Proxy Server*.

1. Enter the IP address or name of the proxy server.
2. If desired, specify addresses that should not use the proxy server (i.e. intranet addresses).

Touch **OK** to enable the proxy server connection and return to the “Security Setup” window. Then touch **Close** to return to the setup menu.

Cresnet

The **Cresnet** button opens the “Cresnet Setup” window, which allows you to enable or disable Cresnet and permits changing the Cresnet ID.

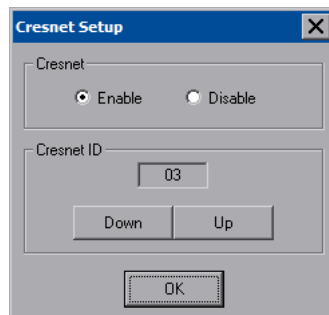
“Cresnet Setup” Window

Select **Enable** for normal Cresnet communication mode and **Disable** when the touch screen is connected to a control system via Ethernet. Communication mode is factory set to **Enable**.

The Cresnet network identity number (*Cresnet ID*) is displayed in the “Cresnet Setup” window. Cresnet ID is a two-digit hexadecimal number. The hexadecimal number can range from 03 to FE and must correspond to the Net ID set in the SIMPL Windows program of the Cresnet system. Matching IDs between touch screen and SIMPL Windows program is required if data is to be successfully transferred. The Net ID for the TPMC-12L is factory set to 03. No two devices in the same system can have the same Net ID.

Two buttons below the hexadecimal display, **Down** and **Up**, decrease and increase the Cresnet ID by one, respectively.

Select **OK** to accept the changes and return to the setup menu.

Touch Screen

The **Touch Screen** button opens the “Touch Screen Settings” window, which provides access to touch screen calibration when you touch **Calibrate Touch Screen...**

“Touch Screen Settings” Window

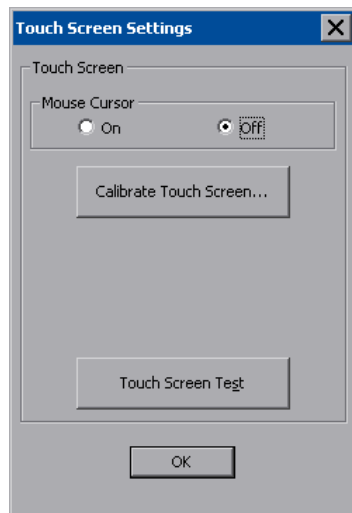

To view the mouse cursor on the touch screen, select **On** in the *Mouse Cursor* section of the window. The mouse cursor will only be displayed if a mouse is connected to the touch screen.

When **Calibrate Touch Screen...** is touched, the calibration screen will be displayed. Touch the screen to begin the calibration process. If the screen is not touched within sixty seconds, the calibration sequence will stop and the screen will return to the “Touch Screen Settings” window.

If the screen is touched before the sixty second timeout, the screen instructs you to touch the center of each target as it appears. There will be a series of crosshairs on the screen, starting near the upper left corner. Touch the center of the first crosshair to initiate calibration. As each new crosshair is touched, the next will appear. After the upper left, crosshairs will appear in the upper center, upper right, middle left, screen center, middle right, lower left, lower center and finally lower right. Touch the center of the crosshair in the lower right of the screen to conclude calibration and return to the “Touch Screen Settings” window. Touch **OK** to accept the changes and return to the setup menu.

NOTE: When touching the screen during calibration, be as accurate as possible. Use the tip of a capped pen or the eraser end of a pencil. To cancel calibration and return to the “Touch Screen Settings” window without saving calibration data, create a calibration error by touching the screen in the same spot for each calibration point.

NOTE: The touch screen’s calibration routine can also be accessed through Crestron Toolbox if the touch screen is connected to a control system via Cresnet and/or TCP/IP by selecting the device from the Network Device Tree and right-clicking the

device to select **Functions | Setup Mode....** Select **Enter Calibration Mode** to begin calibration.

When **Touch Screen Test** is touched, the test screen will be displayed (refer to illustration below). This screen allows the user to test the touch screen response at 17 points on the screen. Each button on the screen will light when touched. Touch **Return** to exit the test screen.

Touch Screen Test Window

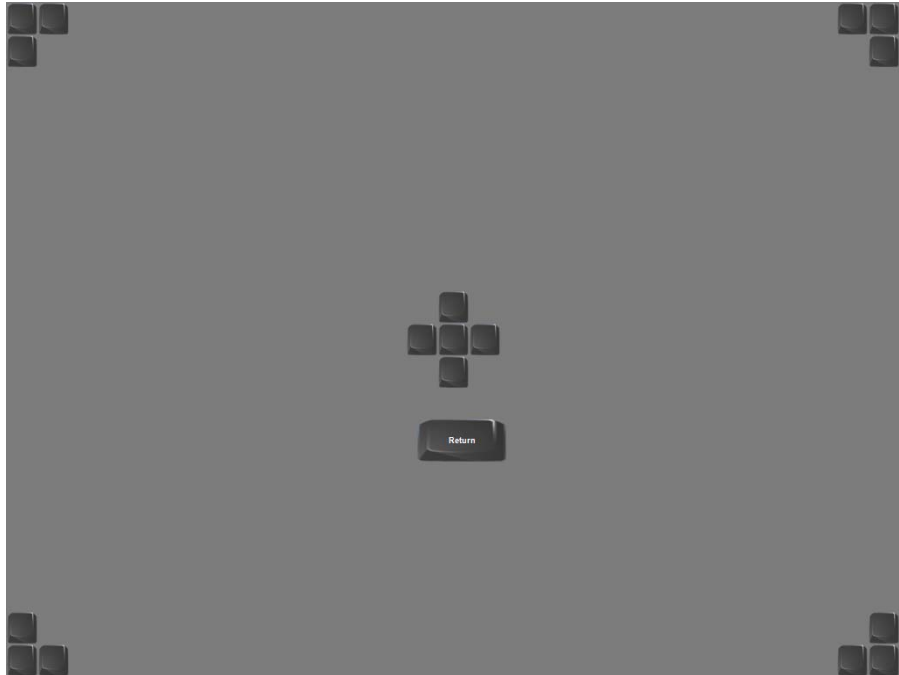

Display Output

Touching **Display Output** shows the display resolution of the touch screen and provides test charts for adjusting skew, peak and boost settings on a remote display.

“Display Output” Window

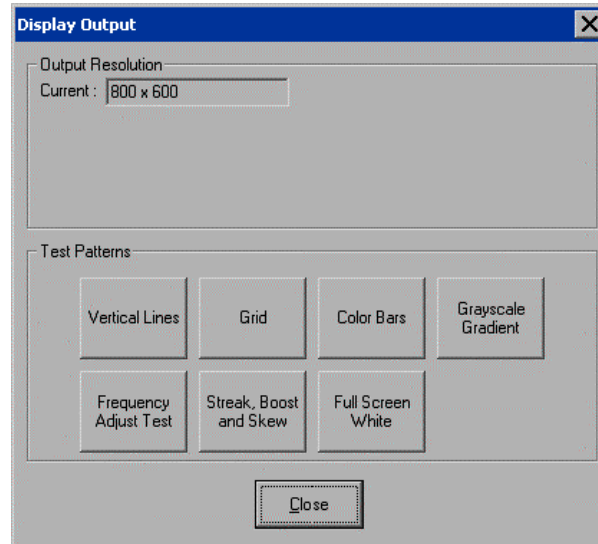

Select the following *Test Patterns*, in the following order and adjust the display as necessary.

1. **Vertical Lines**
2. **Grid**
3. **Color Bars**
4. **Grayscale Gradient**
5. **Frequency Adjust Test**
6. **Streak, Boost and Skew**
7. **Full Screen White**

Update Panel

The **Update Panel** button permits the selection of the touch screen program, a .vtz file. It is also used to upgrade firmware.

The *Project* tab of the “Project and Firmware” window is divided into two sections: *Current Loaded Project* and *Load New Project*.

Current Loaded Project displays the name and creation time of the current project.

In the *Load New Project* section, touch **Browse** and select the compiled project (i.e. the .vtz file) to be loaded from a network drive, USB device or flash drive, then touch **Open** to show the source file in the “Project and Firmware” window. Touch **Load** to uncompress the project file, place it in the destination selected in *Target Location to Load the Project to* and display it on the touch screen.

In the *Target Location to Load the Project to* area of the *Load New Project* section, you can choose the location where your uncompressed project files will be stored. The default file location is the internal flash.

NOTE: If there is a mapped network drive on the touch screen, the first time you select **Browse**, it may take some time for the “Open” window to appear.

NOTE: When selecting **Browse**, the contents of the “Recent” folder will not be available.

NOTE: Projects can also be loaded via Crestron Toolbox.

NOTE: If **External** is checked, the display list cannot be viewed via Crestron Toolbox.

NOTE: When loading a project to an external storage device (e.g. MMC card or flash drive), a subdirectory (not the root) must be used as the working path. Otherwise, the upload may fail.

“Project and Firmware” Window – Project Tab

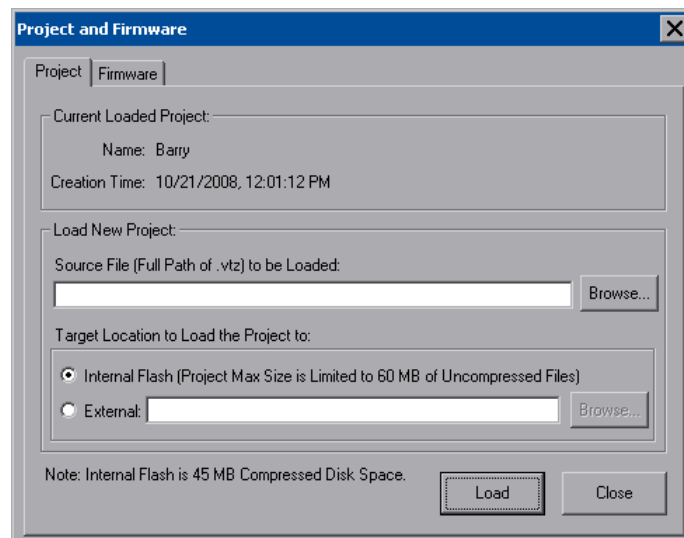

The *Firmware* tab of the “Project and Firmware” window (refer to illustration below) displays the *Current Loaded Firmware* and also has a *Load New Firmware* section.

“Project and Firmware” Window – Firmware Tab

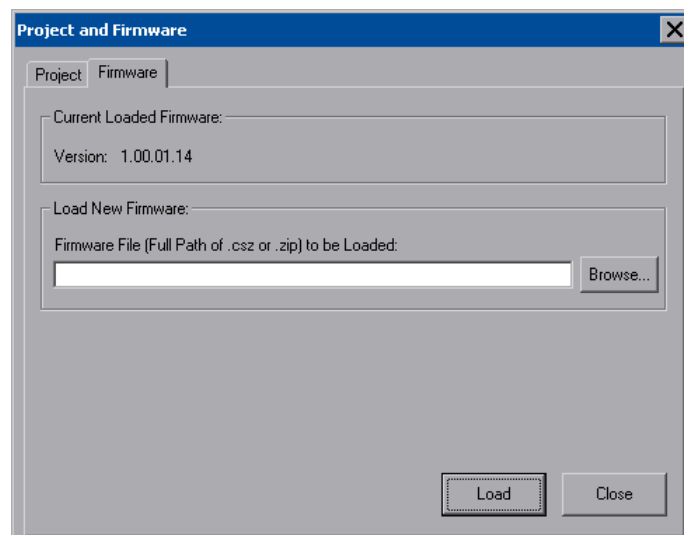

Current Loaded Firmware displays the version of the current firmware.

In the *Load New Firmware* section, touch **Browse** and select the firmware file (i.e. the .csz or .zip file) to be loaded from a network drive, USB device or flash drive. Touch **Load** to load the new firmware.

Video

Each one of the video inputs is selected and adjusted from this window. Touch an input tab and adjust the settings for the selected input.

Video Setup

The setup screen for each video source contains the settings as displayed in the following illustration. Changes are made in real time.

“Video Setup” Window - Video (QM) Tab

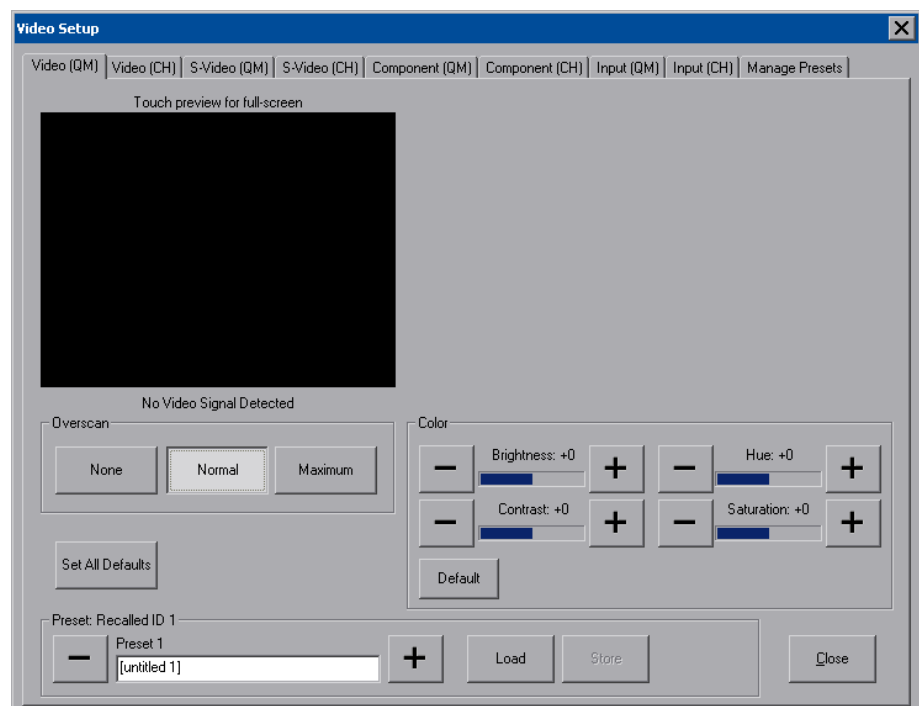

Video is setup using the *Overscan* and *Color* controls. The following test patterns are recommended for adjustment.

Overscan

Overscan is the active image area in a video picture that is outside the edges of the display device. Overscan adjustment first came about because of noise and other artifacts at the beginning and end of the scan lines. To reliably eliminate the noise and fill the screen with a picture, the outside edge of the active picture area was pushed out past the edge of the display area. The average or targeted over-scan loss is about 5 to 10% of the image on each edge. Digital images have nearly eliminated the noise and other artifacts at the edge of the picture, so more of the video image can be safely shown. The **Normal** setting is usually the correct choice for most video inputs.

Presets

Up to 30 presets may be stored for future retrieval.

Input

The *Input (QM)* tab of the “Video Setup” window has controls for adjusting *Peak*, *Boost*, *Skew* and presets for each of the inputs as shown in the following illustration. Changes are made in real time.

“Video Setup” Window - *Input (QM)* Tab

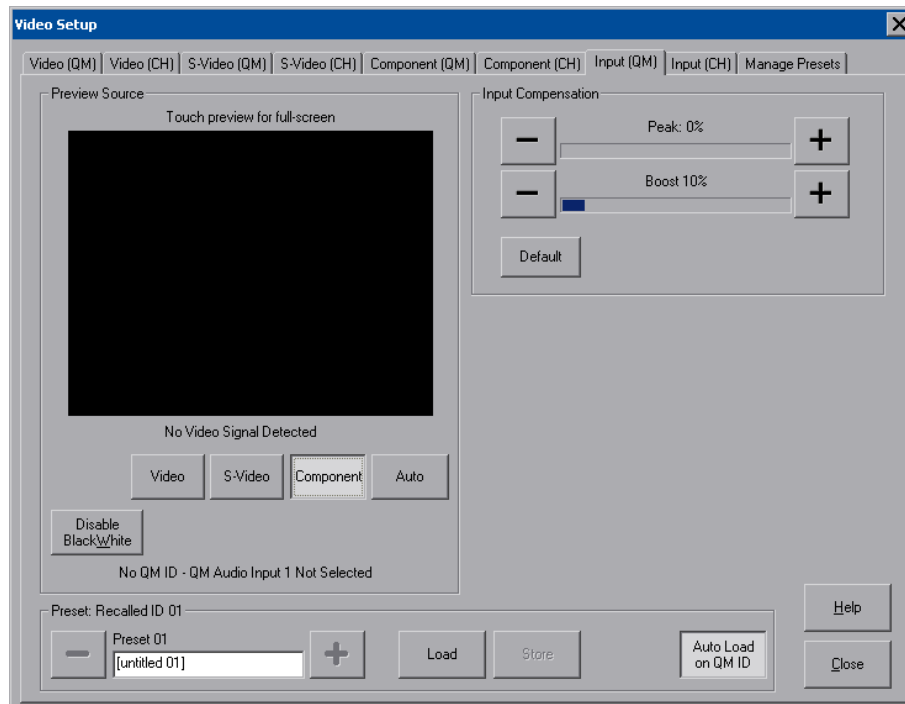

The **Auto** button can be used to auto detect video when a single video source (per input) is connected.

Adjust *Peak* and *Boost* to compensate for white or black streaking.

Up to 255 preset locations are available to store settings for peak and boost. In QM systems using auto compensation, the touch screen can be set to automatically recall preset values upon receipt of a QM ID by selecting **Auto Load on QM ID**.

In order to manually load preset values, make sure **Auto Load on QM ID** is not selected.

For more information on peak and boost settings, refer to the latest revision of the Crestron MediaManager Applications Guide (Doc. 6244).

NOTE: The *Input (CH)* tab of the “Video Setup” window does not have adjustments for *Peak*, *Boost* and *Preset*.

Manage Presets

Use the *Manage Presets* tab to copy presets for position, size and color for one source to other sources.

“Video Setup” Window – Manage Presets Tab

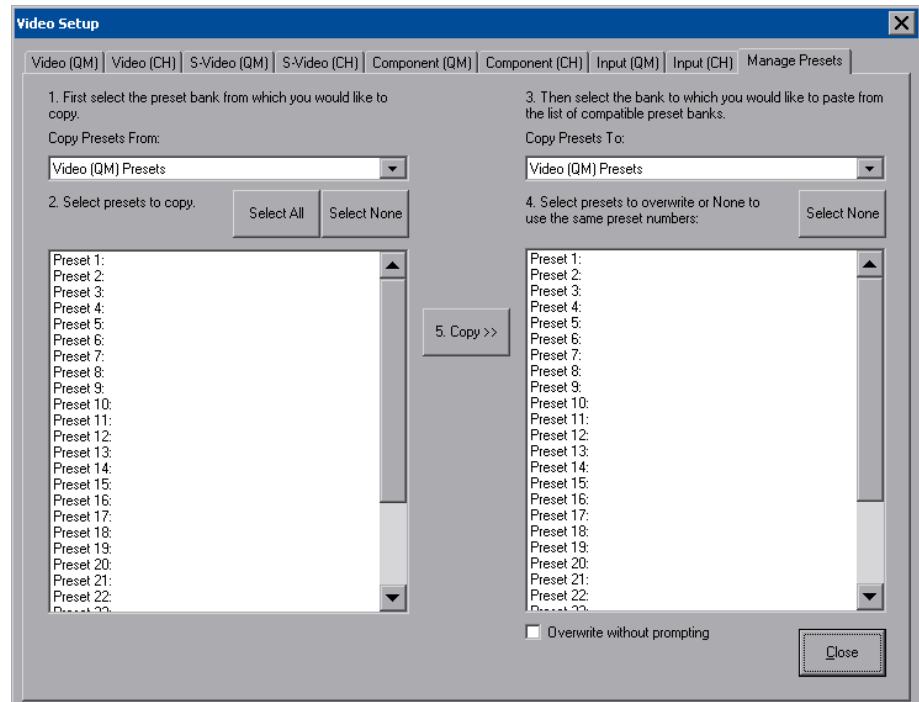

Audio

Touch **Audio** to open the “Audio Setup” window. The *General* tab of the “Audio Setup” window is shown in the illustration on the following page.

In addition to the overall *Speakers* volume and mute controls, volume, balance and mute controls are available for the *Local Audio* outputs. The key click sound has its own volume and mute controls. *Microphone* volume and mute controls are also provided. Defaults are 75 for volume on *Speakers* 25 for volume on *Local Audio* and *Microphone* and zero for *Local Audio* balance. *Key Clicks* default volume is 100.

NOTE: *Microphone* volume and mute controls are for IP Intercom control. These will not affect the analog output.

Touching **Play Test Sound** plays a short internal audio file.

Changes to audio settings are made in real time.

“Audio Setup” Window - General Tab

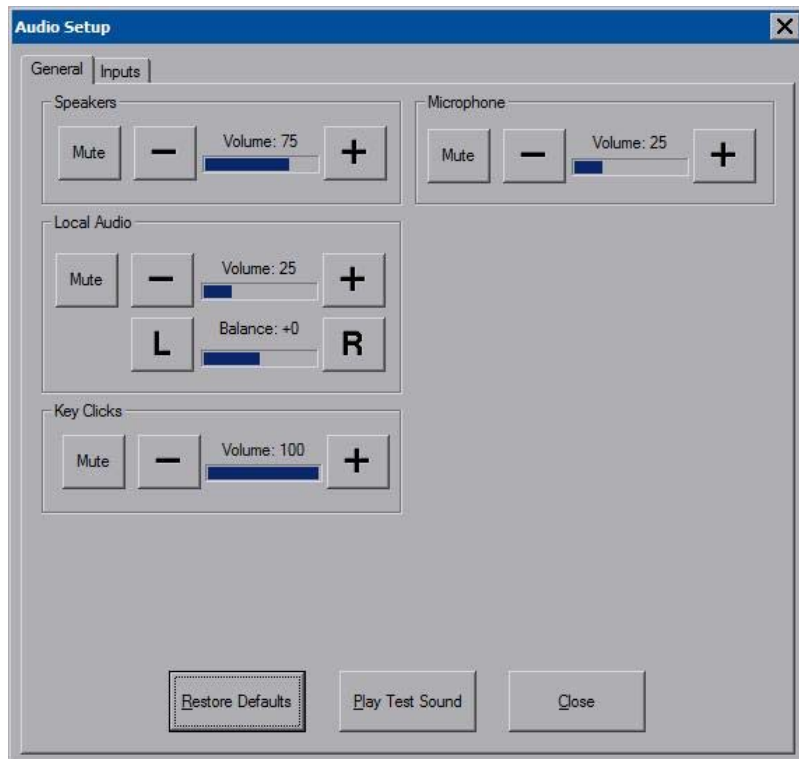

The *Inputs* tab of the “Audio Setup” window is shown in the illustration below.

“Audio Setup” Window - Inputs Tab

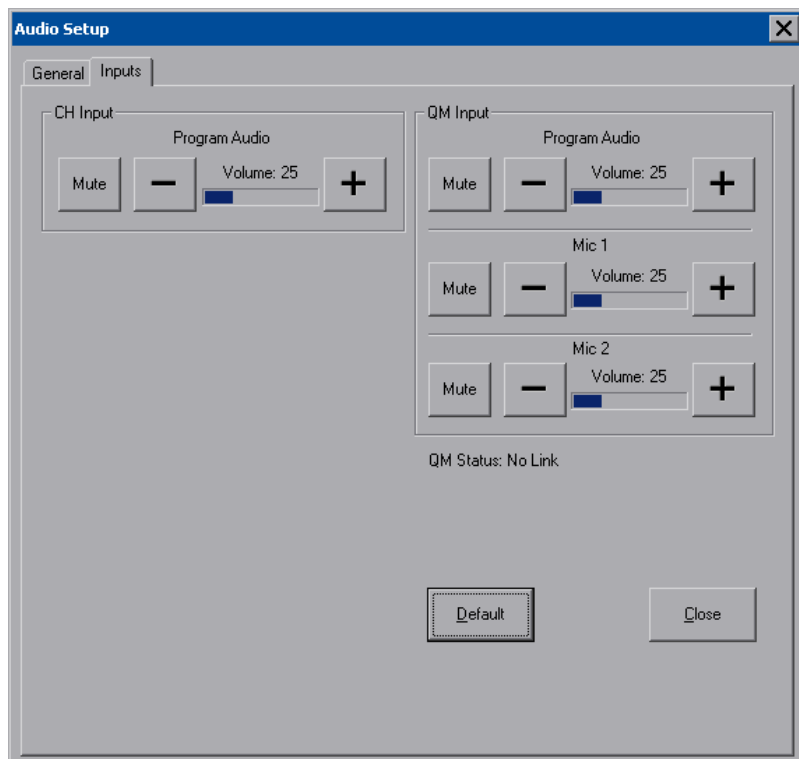

The *CH Input* section of this window contains volume and mute controls for *Program Audio*. The *QM Input* section contains volume and mute controls for *Program Audio, Mic 1* and *Mic 2*.

Annotation

The **Annotation** button displays the “MediaMarker Session Information” window.

“MediaMarker Session Information” Window

The “MediaMarker Session Information” window allows the date, time, author name, session title and session notes to be stored for the current frame. The *Author* dropdown list box contains all the authors available on the system. Authors can be added and removed from the **Edit | Preferences | Authors** menu within MediaMarker, or by touching .

The *Session Folder* browse button permits searching other folders. You may select a flash memory card, a network drive or a USB drive.

The *Default Frame Template* browse button permits you to search for templates. For Crestron provided templates, choose from the pulldown list.

Frames created during the annotation session will use a default annotation template file, frame prefix and frame output file type.

Each new frame title will contain the frame prefix followed by a sequential frame number.

The frame template serves as a starting point for each new frame. Crestron supplies some ready-made templates or you can use one of your own.

Screen captures can automatically save the contents of the current annotation frame to an image file. The file will be saved as the *Default File Type* (.html, .jpg, .bmp, .png or .tif) as specified in the session folder.

For additional information, refer to “MediaMarker” on page 57 and the help file included with the MediaMarker software.

Embed Apps (Embedded Applications)

Touch **Embed Apps** to open the “Embedded Apps” window, which permits you to set Internet security to different levels for different types of Internet sites.

“Embedded Apps” Window

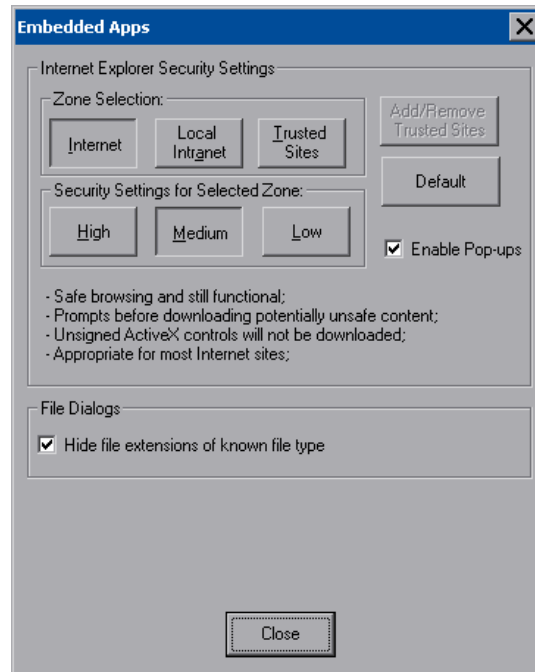

For each of the three zones (**Internet**, **Local Intranet**, and **Trusted Sites**), one of three security levels (**High**, **Medium** or **Low**) can be selected. The security levels are defined as:

- **High:** The safest way to browse but also the least functional. Less secure features are disabled. Appropriate for sites that may have harmful content.
- **Medium:** Safe browsing and still functional. Prompts before downloading potentially unsafe content. Unsigned ActiveX controls will not be downloaded. Appropriate for most Internet sites.
- **Low:** Minimal safeguards and warning prompts are provided. Most content is downloaded and run without prompts. All active content can run. Appropriate for sites you absolutely trust.

Touch **Default** to restore the default security settings. By default, security is set to **Medium** for **Internet** and **Local Intranet** and **Low** for **Trusted Sites**.

The “Embedded Apps” window also permits you to enable the popup windows (child windows) that open when you are in Internet Explorer (not the popup windows of the embedded applications).

NOTE: Refer to the Crestron Web site (www.crestron.com), online help Answer ID 4190, for information on the latest versions of the software.

Touch **Close** after all changes have been made. The touch screen must be rebooted for changes to take effect. Touch **Save & Reboot**, located in the shutdown section of the setup menu.

A list of trusted sites can be created and edited by touching **Add/Remove Trusted Sites**. Touching this button will open the “Trusted Sites” window. From here, trusted sites can be added and edited. Sites are listed by domain name or IP address. Once all sites have been entered, touch **Close**.

“Trusted Sites” Window

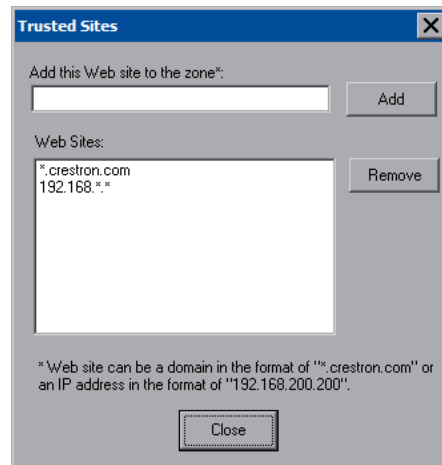

NOTE: Save & Reboot on the setup menu must be selected for Embedded Apps changes to take effect.

NOTE: While browsing the Internet with the TPMC-12L, clicking on a link may cause a message box titled “Restrictions” to appear that contains the text “This operation has been cancelled due to restrictions in effect on this computer. Please contact your system administrator.” If this message appears, checking *Enable Pop-ups* in the “Embedded Apps” window may correct this error. Other restrictions may also cause this error, so this may not prevent all occurrences.

NOTE: The TPMC-12L supports automatic connection to the VNC server when the VNC View application is opened. For automatic connection without having to enter the server location and password every time the VNC viewer is opened, launch the application and using a USB mouse, right-click on the VNC viewer window, then select **Save configuration info as...**

NOTE: Refer to the Crestron Web site, online help Answer ID 4627, for information on how to set up the VNC viewer. Refer to Answer ID 3345 for information on how to program the MJPEG viewer. Refer to Answer ID 4640 for information about the default paths for embedded applications and dynamic graphics.

NOTE: When using the embedded applications, only one document window can be open at a time. Opening a second document window will cause the first document window to close.

NOTE: For NetMeeting to work properly, the *Enable full-duplex audio so I can speak while receiving audio* option needs to be de-selected (i.e. unchecked) in the *Audio* tab of the “Options” dialog. The dialog can be accessed by selecting **Tools | Options**. This will need to be done for NetMeeting each time the touch screen is rebooted.

ETHERNET Details

The Ethernet portion of the setup menu allows configuration of the touch screen settings for Ethernet communications.

The Crestron Swirl logo  at the top of the Ethernet portion of the setup menu illuminates to indicate the status of your connection to the control system(s):

- Green Connected
- Yellow Network trouble
- Orange Connected to some but not all of the control systems (listed in IP table)
- Red Not connected to any control system (listed in the IP table)

NOTE: After configuring Ethernet settings (e.g. changing IP address, etc.), wait at least five seconds after seeing the change in the *Ethernet Status* section of the main setup menu before initiating a **Save & Reboot** to save the new settings.

Adapters

Touch the **Adapters** button to access the “Ethernet Setup” window. Changes are made in real time and there is typically no need to reboot. The Ethernet address and mask are displayed on this screen.

“Ethernet Setup” Window

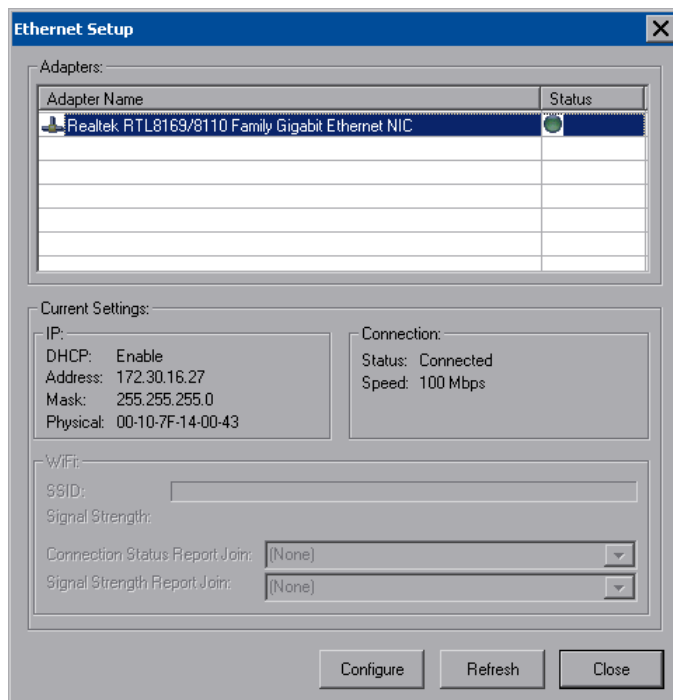

To configure the Ethernet adapter, touch its name once to select it in the *Adapter Name* list. Then, touch **Configure** to open the “Local Area Connection Properties” window. This window displays the connection and related required items.

NOTE: When configuring an adapter, only one item can be modified at a time. For example, to modify an IP address and also change authentication, touch **Configure**

and modify the IP address, then touch **OK** (you must return to the “Ethernet Setup” window). Touch **Configure** again, change authentication, then touch **OK**. The order in which modifications are performed does not matter.

“Local Area Connection” Window

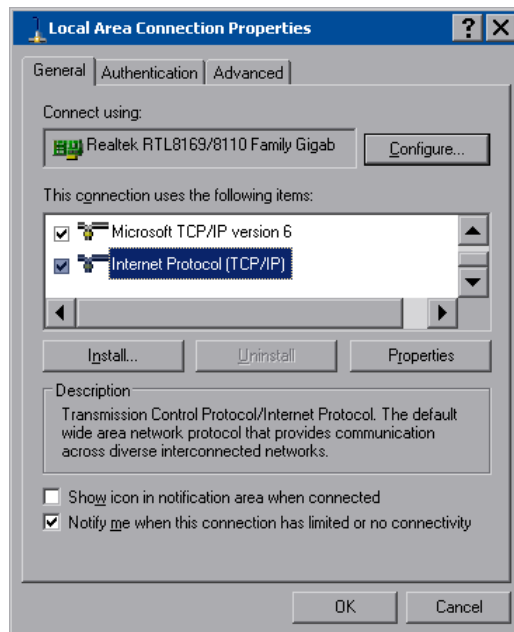

To establish dynamic or static processing, select **Internet Protocol (TCP/IP)** and touch **Properties**.

“Internet Protocol (TCP/IP) Properties” Window

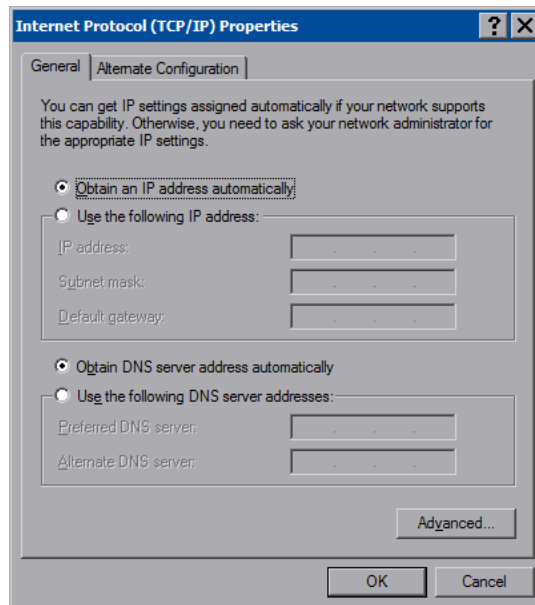

Transmission Control Protocol/Internet Protocol (TCP/IP) is a set of protocols that defines how to transfer data between two computers. TCP monitors and ensures correct transfer of data. IP receives the data from TCP, breaks it up into packets and

ships it off to a network. The IP address is a unique number consisting of four parts (called “octets”) separated by dots, e.g., 165.113.245.2.

Dynamic Host Configuration Protocol (DHCP) is a protocol for assigning dynamic IP addresses to devices on a network. With dynamic addressing, a device can have a different IP address every time it connects to the network. In some systems, the IP address of the device can even change while it is still connected. DHCP also supports a mix of static and dynamic IP addresses.

Dynamic addressing simplifies network administration because the software keeps track of IP addresses rather than requiring an administrator to manage the task. New computers can be added to a network without manually assigning each one a unique IP address.

NOTE: The TPMC-12L ships with DHCP enabled.

Static IP addresses on a dedicated AV/control system allow the integrator to have a fixed/controllable network. This helps maintain communication stability between Ethernet devices.

IP Table

Touch **IP Table** on the setup menu to open the “IP Table Setup” window.

Edit, remove or enter a control system’s IP address in the IP table to enable communication between the touch screen and a control system. The touch screen can communicate with multiple control systems.

For more information on IP tables, refer to the latest version of the Crestron 2-Series Control Systems Reference Guide (Doc. 6256).

“IP Table Setup” Window

IP ID	Type	Address	Dev ID	Port

IP Settings

IP ID: Type: IP Address or Hostname: Dev ID (JNR)*: Port (41794)*:

* Entries are optional and if not specified, the default will be used.

Autodiscovery

The IP ID is the ID number that is used to identify the touch screen in the control system’s IP table. The IP ID should match the IP ID set in the SIMPL Windows program.

Identity

Touch **Identity** to open the “Network ID” window. The “Network ID” window displays the hostname and workgroup that identify the touch screen on the network. The hostname may be used when transferring a program over Ethernet using Crestron Toolbox. This window permits editing of the hostname and workgroup.

“Network ID” Window

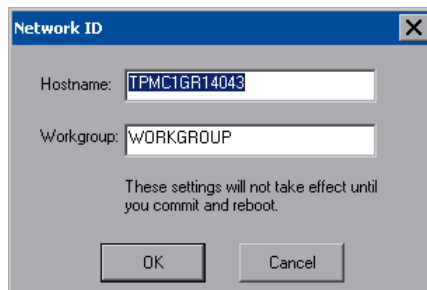

NOTE: The hostname is required for Ethernet communication.

Sharing

Touch **Sharing** to open the “Configure Shared Folders” window. This window is used to set up shared folders. Sharing enables remote computers to view and/or modify files stored on the touch screen.

“Configure Shared Folders” Window

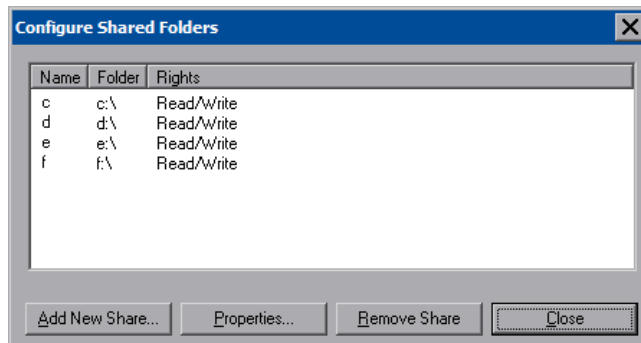

Touch **Add New Share...** to browse and add directories with permission to read-only or read/write. Touch **Close** after adding all folders to be shared.

NOTE: For security reasons, there is no persistence of the shared drive(s) after the touch screen is rebooted.

Standby Details

The *Standby* function turns off the backlight when the touch screen is inactive for a specified time. Use the **Up** and **Down** buttons to set the *Standby* from 0 through 120 minutes, where 0 disables the timeout. Touch the screen to reactivate the touch screen from standby mode. When the touch screen is reactivated, the last screen to be displayed reappears.

NOTE: The hard buttons will still function when the touch screen is in standby mode but will not cause it to awaken from standby. You must touch the screen to reactivate the touch screen.

Hard Button Backlight Details

The *Hard Button Backlight* can be varied from 0 to 100. To increase the brightness, touch **Up**. To decrease the brightness, touch **Down**.

Misc. Controls Details

The *Misc. Controls* section of the setup menu contains the **Diagnostics** and **Keyboard** buttons.

Diagnostics

Touch **Diagnostic** to display the firmware version number, see *Installed Packs* and to reset the end user license from the “Diagnostics” window.

“Diagnostics” Window

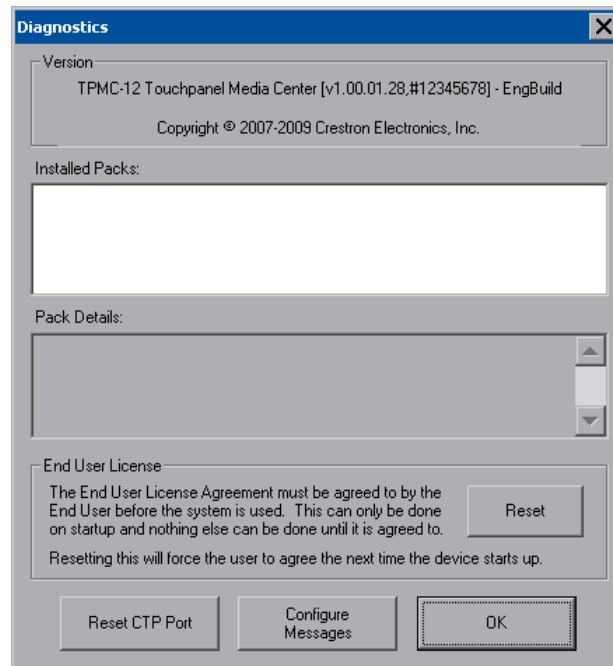

Reset CTP Port resets the default value of the CTP port to 41795, for terminal connection using Crestron Toolbox.

To configure the appearance of popup messages, touch **Configure Messages**. The “Message Popup Configuration” window will open.

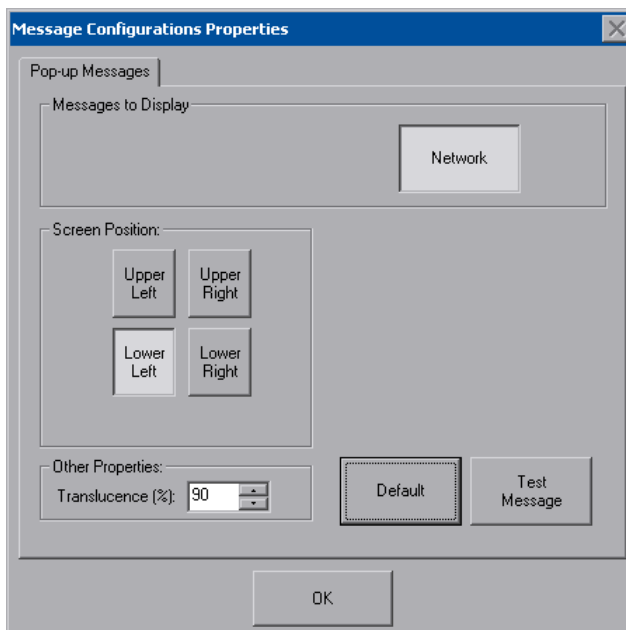
“Message Popup Configuration” Window

There are three types of **Network** popup messages. Following are definitions of each message type:

- **Connected:** A green popup message appears when the touch screen is connected to the control system.
- **Checking Connection:** A yellow popup message appears when the touch screen is experiencing network issues.
- **Disconnected, Trying to Reconnect...:** A red popup message appears when the touch screen loses connection with the control system.

A control for popup message *Translucence* is also provided. Translucence ranges from 25% to 100%, with a default value of 90%.

The **Default** button restores the original *Screen Position* and *Translucence* settings, as well as enabling display of *Network* messages. A **Test Message** button lets you see the changes to popup message position and translucence. Touch **Close** to close the popup window.

NOTE: The default value for *Screen Position* is *Lower Left*.

Show Keyboard

Touch the **Keyboard** button to display the on-screen keyboard.

The on-screen keyboard can be used in an identical manner to a physically connected keyboard. It can be used in any of the embedded applications, for example, to enter a web address or to enter data into a spreadsheet, etc.

The on-screen keyboard also has a few special keys:



Volume down



Volume up



Right click: simulates right-click of mouse



Size: toggles on-screen keyboard size (small, medium, large)



Keyboard transluence down: decreases keyboard transluence



Keyboard transluence up: increases keyboard transluence

On-Screen Keyboard

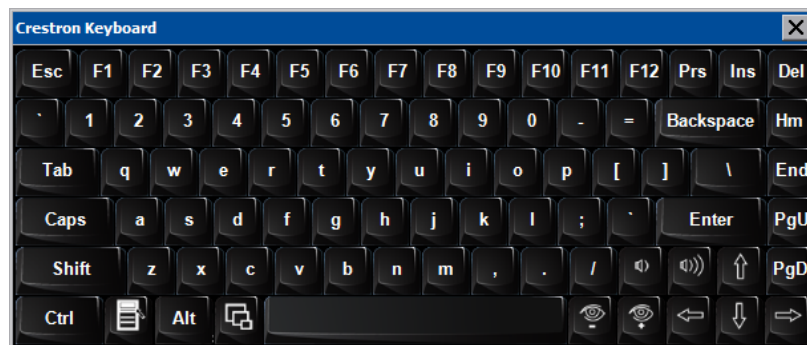

The initial position of the on-screen keyboard is determined by the VT Pro-e program or SIMPL Windows settings. The on-screen keyboard will default to its largest size.

In use, when the on-screen keyboard is moved and/or resized and then closed, it will re-open in the same position it was in and at the same size it was when closed. This position and size will remain in memory until the touch screen is re-booted or it is re-set by the SIMPL Windows program. After reboot, the position of the on-screen keyboard will revert to the defaults set in the VT Pro-e or SIMPL Windows program. The size will revert to the largest as determined by the firmware installed in the touch screen.

Exit the on-screen keyboard by selecting by touching the “X” close button in the upper right corner of the keyboard window. If the **Keyboard** button on the start menu is still visible, you can also touch it to exit the keyboard.

Screen Brightness Details

The *Screen Brightness* can be varied from 0 to 100. To increase the brightness, touch **Up**. To decrease the brightness, touch **Down**.

Hard Button Feedback Details

The *Hard Button Feedback* section of the setup menu provides visual feedback for all hard button presses. Pressing any of the hard buttons (except Reset) will result in its corresponding icon on the screen illuminating in bright green

Ethernet Status Details

The *Ethernet Status* section of the setup menu provides a *Link Status* light to indicate an Ethernet connection and displays the current IP and MAC addresses.

Save & Reboot and Shutdown Details

To save any changes and reboot the touch screen, touch **Save & Reboot**, located in the lower right section of the setup menu.

To turn off the touch screen, touch **Shut Down**, located in lower right section of the setup menu. This is the recommended method for shutting down the touch screen. After the touch screen has shut down, the power supply can be safely removed from the touch screen.

Exit Details

Touch **Exit** to leave the setup menu and return to the project. If no project has been loaded, the touch screen will display an error message and return to the setup menu.

Mounting Options

The TPMC-12L touch screen installs simply and cleanly into existing or newly constructed walls with an assortment of pre- and post-construction mounting options. All mounting options are provided separately from the actual touch screen. Refer to the following table for a complete list of mounting options and respective Installation Guides for this touch screen.

TPMC-12 Mounting Options

PRE-CONSTRUCTION OPTION	POST-CONSTRUCTION OPTION	MODEL NUMBER	DOCUMENT NUMBER
Back Box Kit	-	BB-12L	6357
Pre-Construction Mount Kit	-	PMK-12L	6358
Mud Mount Kit (Accessory)	-	MMK-12L	6359
Trim Mount Kit (Accessory)	-	TMK-12L	6360
-	Wall Mount Kit - Mud	WMKM-12L	6359
-	Wall Mount Kit - Trim	WMKT-12L	6360

NOTE: Pre-construction refers to framed walls prior to hanging drywall. Post-construction refers to framed walls with drywall hung.

NOTE: There is also a rack mount kit (RMK-12) available for the TPMC-12L touch screen. Refer to the latest version of the RMK-12L Installation Guide (Doc. 6361).

Touch Screen Mounting

Tools Required: #2 Phillips tip screwdriver

1. If the cover plate is attached, use a #2 Phillips screwdriver to loosen and remove the four screws and plate.
2. Connect all required cables to the touch screen. Refer to “Hardware Hookup” which starts on page 41 for details.
3. Insert the touch screen (without its bezel) into the mounting option and align the eight screw holes.

4. Insert and tighten the eight supplied screws (finger tight and then using a #2 Phillips screwdriver, tighten an additional 1/8-turn).
5. Cover the mounted unit with the bezel. Refer to the illustration following this step.

Exploded View of Mounting the TPMC-12L in the Optional BB-12L Back Box

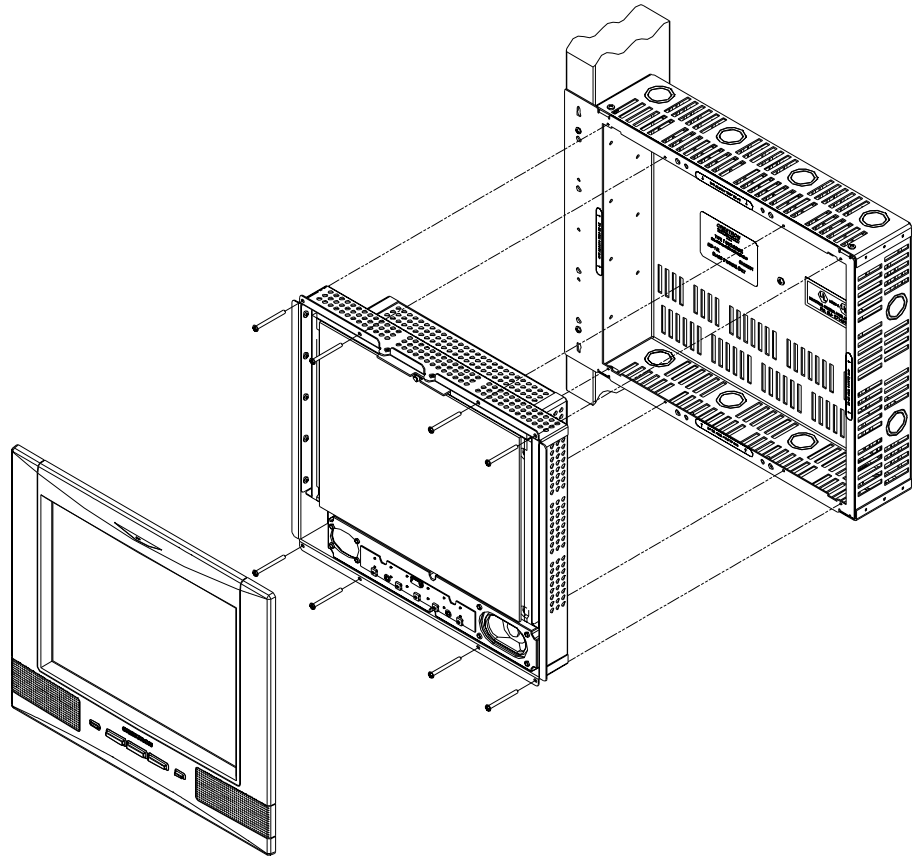

Touch Screen Removal

If it is necessary to remove the touch screen after it has been installed into a mounting surface, complete the following steps in the order provided to remove the touch screen. The only tool required is a #2 Phillips tip screwdriver.

1. Lift the bezel off the touch screen. Do not apply excessive pressure to the touch screen.
2. Loosen and remove the screws that secure touch screen to the mounting option in use.
3. Using equal pressure, carefully remove the touch screen from the opening.
4. If necessary, secure and label the attached cables before disconnecting them from the back of the touch screen.

Hardware Hookup

Ventilation

The TPMC-12L should be used in a well-ventilated area. The venting holes should not be obstructed under any circumstances. If the TPMC-12L is hot to the touch, consider used forced air ventilation.

To prevent overheating, do not operate this product in an area that exceeds the environmental temperature range listed in the table of specifications. Consideration must be given if installed in a closed or multi-unit rack assembly since the operating ambient temperature of the environment may be greater than the room ambient temperature. Contact with thermal insulating materials should be avoided on all sides of the unit.

Connect the Device

Make the necessary connections as called out in the illustration that follows this paragraph. Refer to “Network Wiring”, “CAT5 Wiring” and “QuickMedia Wiring” on page 13 before applying power. If the TPMC-CH-IMC is to be used for connecting CAT5 audio and CAT5 video, refer to the latest revision of the TPMC-CH-IMC Operations Guide (Doc. 6345) for more information.

Hardware Connections for the TPMC-12L

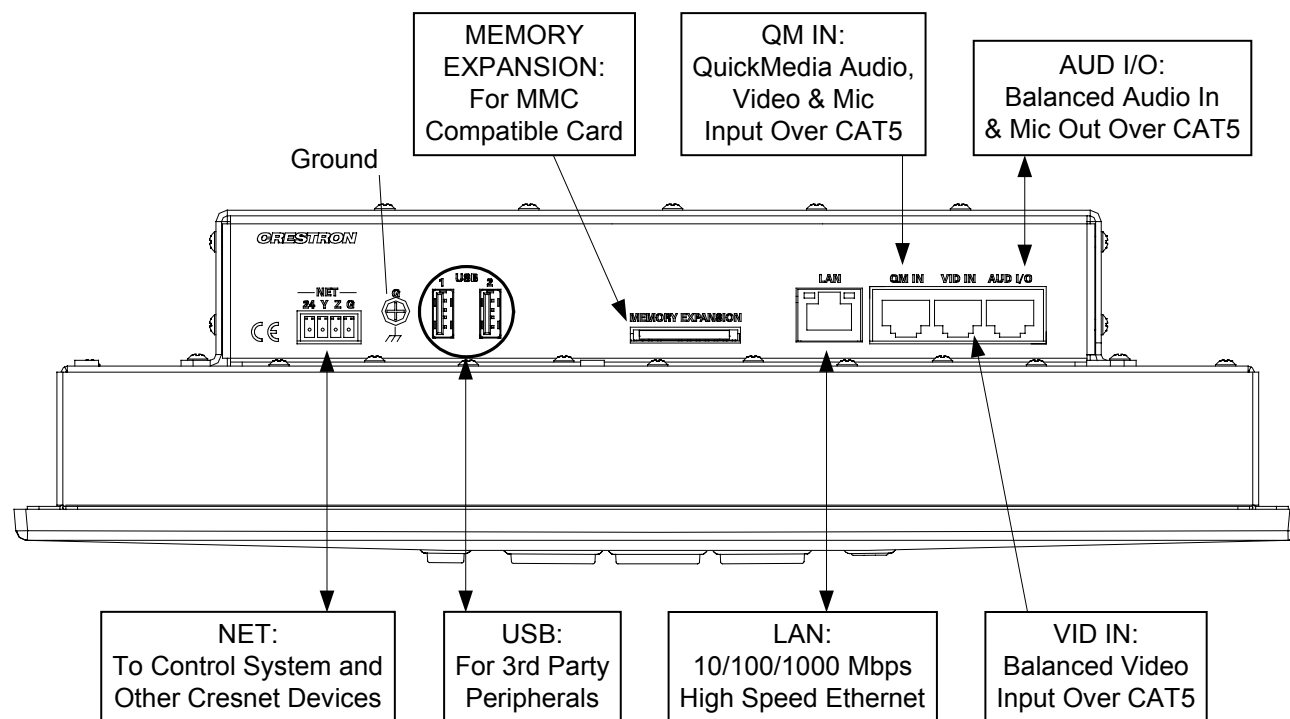

CAUTION: Do not apply excessive pressure to the touch screen display during handling. Doing so can crack the screen and damage the touch screen.

CAUTION: Use only the TPMC-CH-IMC Interface Module when connecting to the **VID IN** port. Use of the older “IMC” products, such as those with a 10-pin RJ-45 based interface, could damage the touch screen.

NOTE: Ensure the unit is properly grounded by connecting the chassis ground lug to an earth ground (building steel).

NOTE: The TPMC-12L can only be powered by the 4-position terminal block connector labeled **NET**. Power cannot be supplied from network devices that are connected to the mini-terminal block connectors.

NOTE: The Y and Z Cresnet data lines from the network are connected to the **NET** connector, which is internally wired to the 4-position mini-terminal block connector at each QM connector. (Does not necessarily apply to all QM products.)

NOTE: The maximum continuous current from equipment under any external load conditions shall not exceed a current limit that is suitable for the minimum wire gauge used in interconnecting cables. The ratings on the connecting unit's supply input should be considered to prevent overloading the wiring.

NOTE: Be sure to set Cresnet to *Disable* when using Ethernet. Refer to “Cresnet” which starts on page 20 for details.

NOTE: For optimum performance, Crestron strongly recommends using CresCAT-QM cable, available from Crestron. Other high-quality/low skew CAT5e/CAT6 wiring may also be used with varying performance.

NOTE: For CAT5 and QuickMedia connections, use Crestron Certified Wire.

NOTE: A QuickMedia transmitter such as the QM-TX is required in order to connect conventional video and audio sources to the **QM IN** port. The QM port is not connected through any “IMC” interface.

NOTE: TPMC-12L touch screens include a TPMC-CH-IMC Interface Module for system connection. The TPMC-CH-IMC serves as an interface between the touch screen, external A/V system, microphone output and the Cresnet system. Refer to the TPMC-CH-IMC Operations Guide (Doc. 6345) for hardware hookup using this interface.

NOTE: U3 type smart drives are not supported by the TPMC-12L.

NOTE: When booting the TPMC-12L, the only USB devices supported are a keyboard or mouse. Having a USB drive or hub connected will interfere with proper booting of the touch screen.

NOTE: After inserting a USB device or MMC card, a “Found New Hardware” window may appear. If this window appears, click “Yes” to close the window.

TPMC-CH-IMC Interface Module

For networks without CAT5 audio and video, the TPMC-CH-IMC Interface Module (as well as a 15 foot “triamese” interface cable) is included to convert unbalanced video sent over coax cable and balanced/unbalanced audio sent over shielded, twisted-pair wiring to Crestron Certified Wire for connection to the touch screen.

NOTE: The TPMC-CH-IMC is not for use with QuickMedia.

NOTE: Audio and video wiring between the touch screen and module may be as long as 500 feet (152 meters) for component video or 750 feet (229 meters) for composite and S-video. However, the length of Cresnet cable must account for limits based upon the touch screen power requirements. Refer to the latest version of the TPMC-CH-IMC Interface Module Operations Guide (Doc. 6345) and “Network Wiring” on page 13.

QM-TX QuickMedia Transmitter

The QM-TX QuickMedia Transmitter (sold separately) can be used to connect a video or audio source to a QuickMedia network without a locally available QM transmitter (such as the QM-WMC).

The QM-TX accepts composite video, S-video, component video and audio signals. These signals are converted to the QuickMedia standard and fed over a CAT5E or CAT6 cable to a QM receiver (such as the TPMC-12L). All signal routing occurs automatically under the command of the control system.

For more information, refer to the latest version of the QuickMedia Transmitter: QM-TX Operations Guide (Doc. 6334).

Recommended Cleaning

Keep the surface of the touch screen free of dirt, dust or other materials that could degrade optical properties. Long-term contact with abrasive materials can scratch the surface, which may detrimentally affect image quality.

For best cleaning results use a clean, damp, non-abrasive cloth with any commercially available non-ammonia glass cleaner. Bezels may not provide a complete watertight seal. Therefore, apply cleaning solution to the cloth rather than the surface of the touch screen. Wipe touch screen clean and avoid getting moisture beneath the bezels.

Programming Software

Have a question or comment about Crestron software?

Answers to frequently asked questions (FAQs) can be viewed in the Online Help section of the Crestron Web site. To post a question or view questions you have submitted to Crestron's True Blue Support, log in at <http://support.crestron.com>. First-time users will need to establish a user account.

Earliest Version Software Requirements for the PC

NOTE: Crestron recommends that you use the latest software to take advantage of the most recently released features. The latest software is available from the Crestron Web site (www.crestron.com/software).

Crestron provides an assortment of Windows-based software tools to develop a customized system. Use SystemBuilder™ or SIMPL Windows to create a program to control the TPMC-12L.

Programming with Crestron SystemBuilder

SystemBuilder is a comprehensive programming environment. Appropriate for most systems, it can quickly and easily generate a complete working program including both control processor logic and touch screen graphics.

Programming with SIMPL Windows

NOTE: While SIMPL Windows can be used to program the TPMC-12L, it is recommended to use SystemBuilder for configuring a system.

SIMPL Windows is Crestron's premier software for programming Crestron control systems. It is organized into two separate but equally important "Managers": Configuration and Program.

Configuration Manager

Configuration Manager is the view where programmers "build" a Crestron control system by selecting hardware from the *Device Library*.

1. The TPMC-12L must first be incorporated into the system.
 - a. To incorporate the TPMC-12L (Cresnet) into the system, drag the TPMC-12 from the Touchpanels | Touchpanels (Cresnet) folder of the *Device Library* and drop it in the *System Views*.

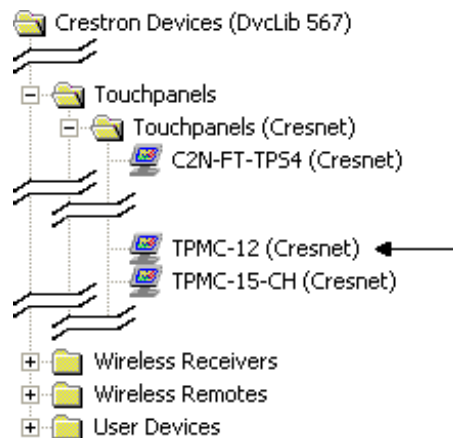
Locating the TPMC-12 (Cresnet) in the Device Library

- b. To incorporate the TPMC-12L (Ethernet) into the system, drag the TPMC-12 from the Touchpanels | Touchpanels (Ethernet) folder of the Device Library and drop it in the System Views.

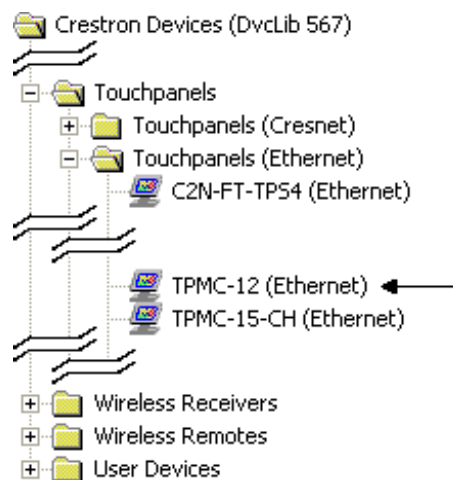
Locating the TPMC-12 (Ethernet) in the Device Library

The system tree of the control system displays the device in the appropriate slot with a default Net ID or IP ID as shown in the following illustration.

NOTE: In the following illustration, there is both an Ethernet device in Slot 8 and a Cresnet device in Slot 9. It is possible to have both types of device attached to a control system as long as the control system has either a built-in or expansion Ethernet interface. If Cresnet operation is desired, the IP table for the TPMC-12L must be empty.

C2ENET-2 and C2Net Devices, Slot 8 and 9

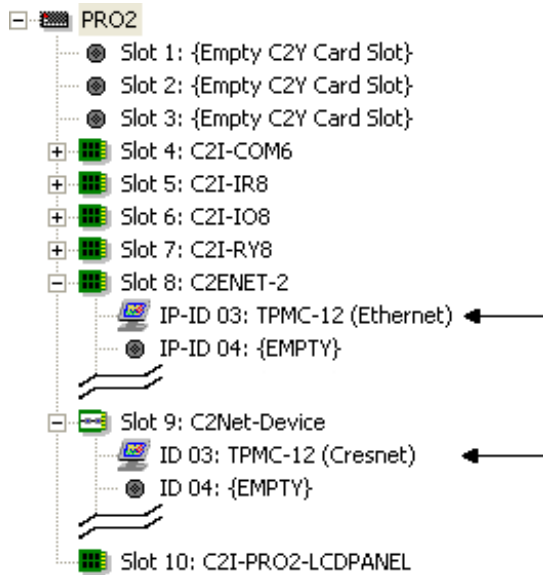

2. If additional TPMC-12L devices are to be added, repeat step 1 for each device. Each TPMC-12L device is assigned a different Net ID or IP ID number as it is added.
3. If necessary, double click a device to open the “Device Settings” window and change the Net ID or IP ID, as shown in the following figures.

“Device Settings: Crestron TPMC-12 (Cresnet)” Window

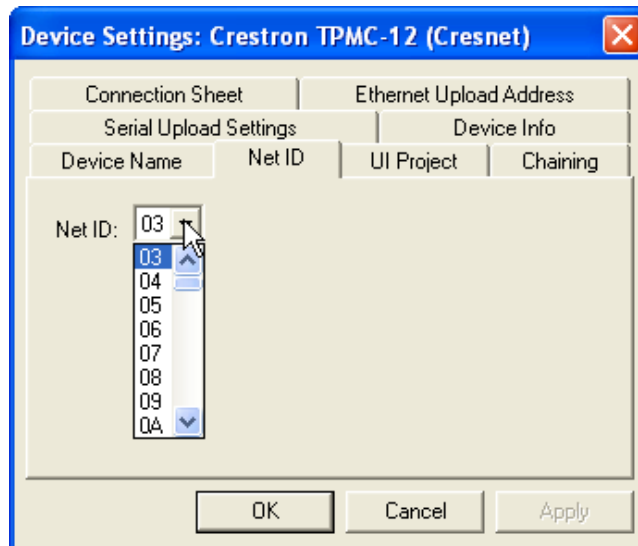

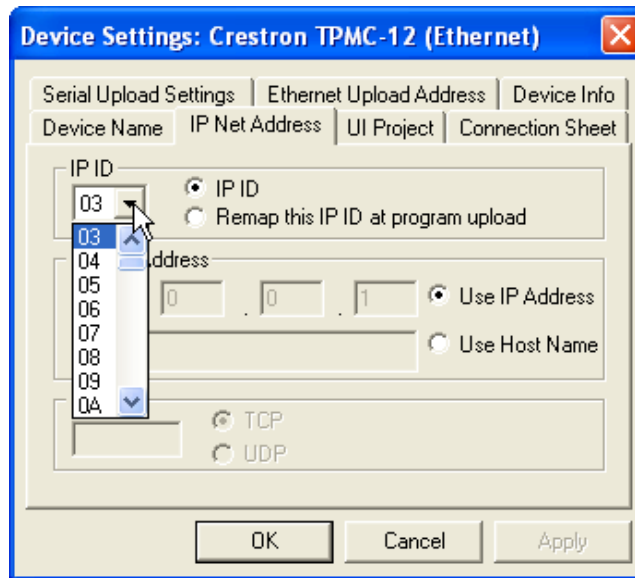
“Device Settings: Crestron TPMC-12 (Ethernet)” Window

NOTE: The ID code specified in the SIMPL Windows program must match the Net ID or IP ID of each unit. Refer to “Identity Code” on page 15.

Program Manager

Program Manager is the view where programmers “program” a Crestron control system by assigning signals to symbols.

The symbol can be viewed by double clicking on the icon or dragging it into *Detail View*. Each signal in the symbol is described in the SIMPL Windows help file (**F1**).

Programming with VisionTools

Touch screen pages should be created in Crestron VisionTools (VT Pro-e) to allow accessing the embedded applications, switching of source signals to desired outputs as well as selection of the system mode. There are no special programming requirements to use the functions of the TPMC-12L in a room control system.

Multi-Mode Objects

Multi-mode objects offer high-performance programming!

The single most advanced VT Pro-e high performance programming technique involving the TPMC-12L is the concept of multi-mode objects. A multi-mode object (i.e. button, legend, etc.) is an object drawn on a VT Pro-e page that can have one or more active and inactive visible settings (*modes*).

For examples, refer to www.crestron.com/exampleprograms and search for multi-mode object examples. This file contains the VT Pro-e touch screen files and SIMPL Windows files that illustrate the high-performance capabilities of multi-mode objects.

WAV File Audio Messages

The TPMC-12L touch screens are capable of playing audio messages as system prompts and responses. These files are recorded as WAV files on a PC using an audio utility such as Sound Recorder that is packaged with Microsoft Windows. Files from other sources may also be converted to an acceptable format by using this or a similar utility. Many other audio utilities are available commercially or as shareware. The TPMC-12L touch screens only accept the following WAV file format: **PCM, 8**

and 16 bit, 8 – 44.1kHz, mono and stereo. For more information about how to use Sound Recorder, refer to its User's Guide and extensive help information provided with the software. Also refer to the help file in VT Pro-e to learn how to use its audio tool, Sound Manager, to attach WAV files to a touch screen project.

Pre-recorded WAV files for voice prompts and responses are available from Crestron. These files can be stored into and programmed for use in the touch screen directly or may be edited with the Sound Recorder. For example, the individual files can be combined to create custom messages.

NOTE: Touch screen WAV files can be obtained from the Wave LC Library of the Crestron FTP site.

Bit Depth and File Size

A balance of performance and quality can be achieved by using VT Pro-e to configure the size of graphics in a project. Read this section to learn about bit depth and how to maximize the quality and performance of a TPMC-12L project.

Bit depth refers to the number of memory bits used to store color data for each pixel in a raster image. A touch screen raster image consists of a rectangular grid of picture elements (pixels). Each pixel uses the same amount of memory to store its color data. The amount of memory is called the bit depth of the image.

Greater bit depths are required to represent finer gradations of color. Increasing bit depth necessarily increases file size. A black and white drawing requires only one bit per pixel to store all the available color information. Using a 32-bit per pixel bit depth for a black and white image increases the file size 32 times without adding anything to the black and white image quality.

In an 8-bit per pixel system, the associated 8-bits of video memory for every screen pixel contain a value referring to a location in an 8-bit color table. In this way any one of the specific 256 color table locations is assigned to a pixel.

A 16-bit highcolor system is considered sufficient to provide life-like colors. It is encoded using 5-bits to represent red, 5-bits to represent blue and (since the human eye is more sensitive to the color green) 6-bits to represent 64 levels of green. These can therefore be combined to provide 65,536 mixed colors ($32 \times 32 \times 64 = 65,536$).

In a 24-bit graphics display, the video memory allocates 24 bits for each pixel on the screen enabling each pixel to take on any one of a possible 16.7 million colors. Each 24-bit value is composed of 8-bits for red, 8-bits for green and 8-bits for blue. These triplets of 8-bit values are also referred to as the red, green and blue color planes. A 24-bit image is actually composed of three component images which combine to create the truecolor picture. The reason this is called truecolor is that this is near the maximum number of colors the human eye is able to detect.

Truecolor images are sometimes represented by a 32-bit value. The extra 8-bits do not enhance the precision of the color representation but act as an alpha channel that represents pixel translucence. The 32-bit truecolor has become popular on the computer desktop to provide effects such as translucent windows, fading menus and shadows.

In graphics intensive applications such as touch screens, raising or lowering the color depth of the displayed graphics can achieve a balance of performance and quality. Lower color depths do not require as much frame buffer memory or display bandwidth, allowing them to be generated and displayed more quickly. Increasing color depth results in higher color quality at the expense of display speed and responsiveness. By using mostly 8-bit or 16-bit graphics and holding 32-bit graphics to a minimum (e.g. for a family photo, etc.), you can create a sophisticated project

that will fit in the memory space provided and have the touch screen remain very responsive.

Relationship of Bits to Colors

NUMBER OF BITS	NUMBER OF COLORS
1 bit	Black and White
2 bits	4 Colors
4 bits	16 Colors
8 bits	256 Colors
16 bits	65,536 Colors (Highcolor)
24 bits	16.7 million Colors (Truecolor)
32 bits	16.7 million Colors plus Transparency

When creating a VT Pro-e project you can elect to compress and reduce the image size in the “Page Properties” window for the entire page and/or perform the same function of reducing the image size using the “Image Properties” window. A reduction in image size will save a considerable amount of memory space for your project.

In VT Pro-e, the **Compress** checkbox permits the image to be compressed when compiling. The **16 Bits** checkbox converts a 24-bit or 32-bit image to 16 bits. This conversion to a 16-bit image may cause the loss of some subtle shading. To compensate for this, use the dithering to simulate the original shading. Check your image with each of the available dithering types to determine which will deliver the best quality image.

Dithering type selection can be accessed from the “Page Properties” or “Image Properties” windows in VT-Pro-e. Refer to the following illustrations.

VT Pro-e “Page Properties” Window – Bit Depth Selection

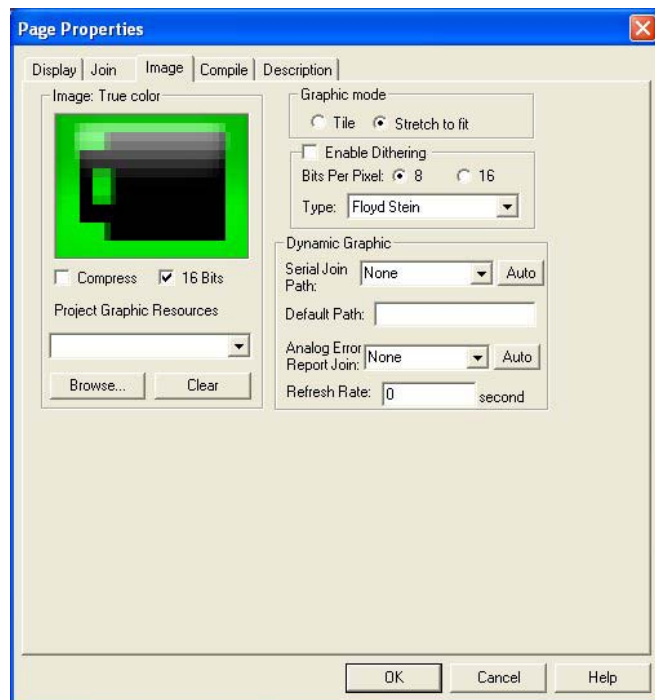

VT Pro-e “Image Properties” Window – Bit Depth Selection

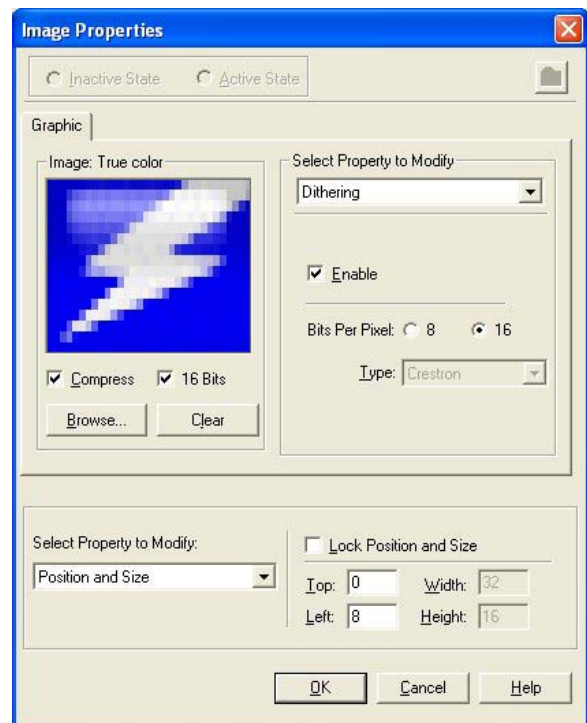

Push Button Programming

Four of the buttons can be programmed to access any frequently used command. Each button has a permanently fixed digital join number. The sequence of digital join numbers is (left to right) 1 through 4. Refer to the following illustration for their assigned join numbers. A description for each button signal is described in the SIMPL Windows help file (F1).

Push Button Layout and Join Number Assignment

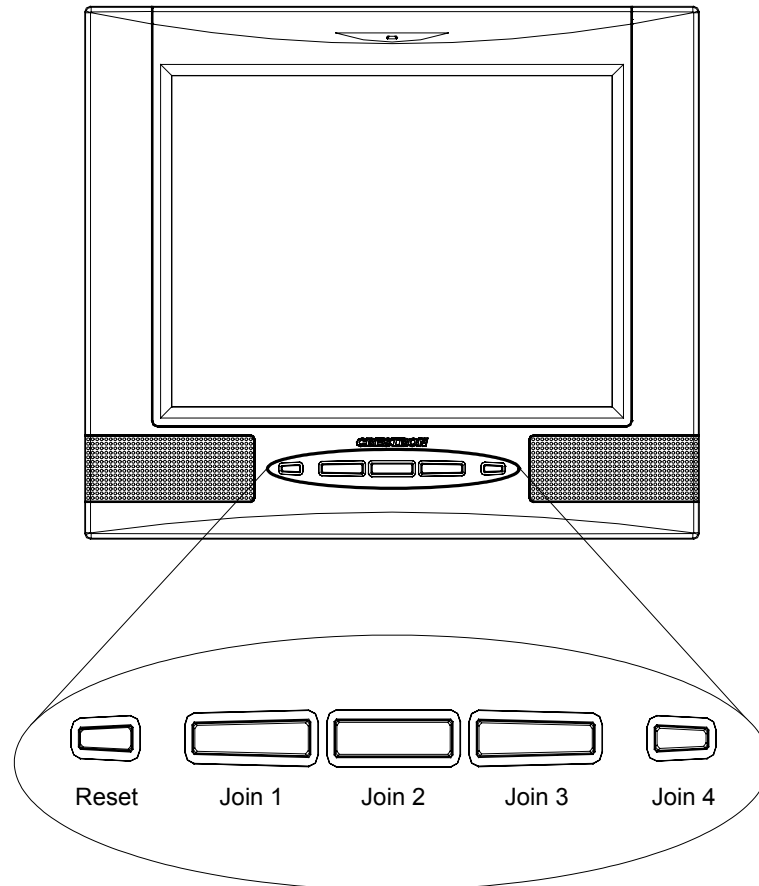

MultiByte International Characters

Most languages use a single byte of eight bits to represent a character, e.g. English, French, German, Hebrew, Russian, Thai, etc.

Multibyte character fonts require more than the usual eight bits to specify a character. This occurs when a language has more than 256 characters (2^8) in a font. For example, Chinese fonts contain several thousand characters. Other multibyte languages include Japanese and Korean.

There are two separate applications with multibyte characters – static text on buttons and indirect text on buttons. No Isys touch screen firmware changes are required in either case.

Indirect text on a button is entered in VT Pro-e and the actual string to be displayed is entered in SIMPL Windows. As of this publication date only completely single byte or completely multibyte strings may be entered or they will not be compiled correctly in SIMPL Windows. In other words, you cannot enter Chinese characters interspersed with numbers. You can enter Chinese characters or numbers in separate

strings or you can pad each number with “\x00” to make it multibyte and then combine it with Chinese characters in the same string.

Of course you can always use the workaround of showing a graphic that displays the string but it is not dynamic. To compile and use multibyte characters it is essential that the operating system understand the language. Some versions of Windows are available in many international languages and add-on software is available for other versions.

Embedded Applications

NOTE: Installations and downloads from within embedded applications are not supported by the TPMC-12L.

A number of third-party or in-house applications are embedded in a VT Pro-e TPMC-12L project. (Refer to illustration on the following page.)

- Adobe Reader
- Microsoft Excel Viewer
- Microsoft Internet Explorer
- Microsoft Word Viewer
- MJPEG Viewer
- NetMeeting
- PowerPoint Viewer
- Real Player
- Remote Desktop
- VNC Viewer
- Windows Media Player
- WordPad

The embedded applications have the following features:

- All embedded applications listed in the VT Pro-e *ProjectView* workspace are created by default for a new TPMC-12L project.
- All applications are created at project-level – one instance per project.
- The static position and size of each application can be viewed from any page.
- Four analog joins can be assigned to each application to dynamically change position and size.
- One digital feedback join or one analog join can be assigned to dynamically show/hide an application.

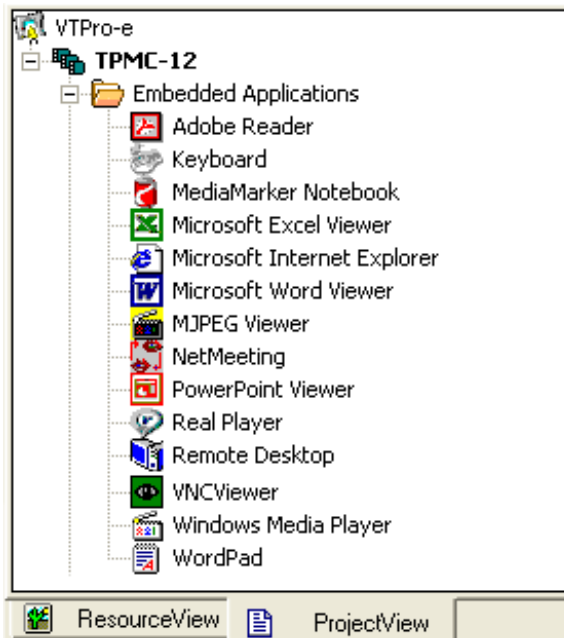
Embedded Applications in ProjectView

Right-click on any of the applications in the *Project View* and select **Properties** to open the “Embedded Application Property” window (refer to the illustration on the following page). This window permits a choice of positions on the screen, assignment of an analog touch join type and number and a show/hide join number.

Defaults for Embedded Windows Applications

Use the *Default Path* text box in the “Embedded Applications Properties” window to enter the default document for the application.

Edit the *Default Position and Size* in the “Embedded Application Properties” window to point to your new location.

Sample of an "Embedded Application Properties" Window

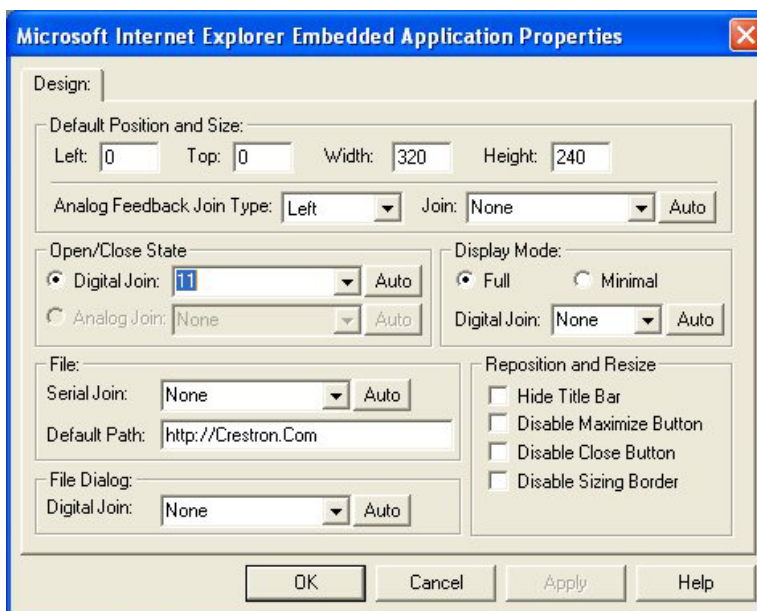

Programming Embedded Windows Applications

The following diagram is an example of a basic SIMPL program that enables you to open/close an embedded application. The example program is discussed following the diagram.

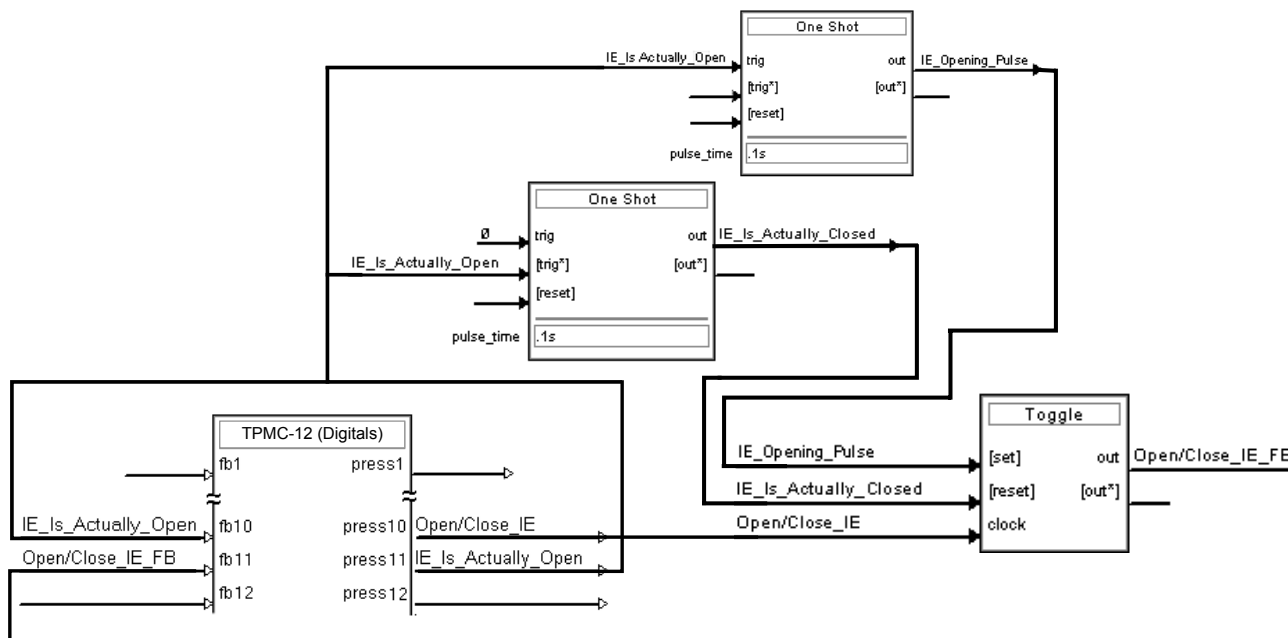

The example has Join #10 assigned to a button that is used to toggle the state of Internet Explorer. Press10 is routed to the clock line of a Toggle symbol. The output of the toggle is routed to fb11. Join #11 is referred to as the "Open/Close State Digital Join." The feedback signal of the Open/Close State Digital Join is used to Open/Close the application. In this example, when fb11 goes high, Internet Explorer opens, and when fb11 goes low, Internet Explorer closes. However, since the

application can also be closed by pressing the "X" in the upper right hand corner of Internet Explorer, we must keep the logic synchronized. If we do not, the toggle will get out of sync. Similarly, using the reserved join to launch the embedded application would result in the application being open, but the state of the toggle remaining low, so a one-shot is used to set the state of the toggle if the embedded application is opened in this way.

For example, the user presses button #10 and the output of the toggle (<Open/Close_IE_FB>) is high. If the user presses the "X" on IE, IE closes. The next time they touch button #10, <Open/Close_IE_FB> will go low, which tries to close the application. However, the application is already closed. We need to reset the state of the toggle to keep in sync with the actual state of the application.

The "Press" signal of the Open Close State Digital Join can be used to know the true state of the application. When Press11 goes high, in this example, IE is open. When Press11 goes low, IE is closed. Here, we use the falling edge of Press11 through a One-Shot to reset the state of the Toggle symbol. Now the toggle is properly synchronized if the user closes the application from the touch screen itself.

Uploading and Upgrading

Crestron recommends using the latest programming software and that each device contains the latest firmware to take advantage of the most recently released features. However, before attempting to upload or upgrade it is necessary to establish communication. Once communication has been established, files (for example, programs, projects or firmware) can be transferred to the control system (and/or device). Finally, program checks can be performed (such as changing the device ID or creating an IP table) to ensure proper functioning.

Establishing Communication

Use Crestron Toolbox for communicating with the TPMC-12L; refer to the Crestron Toolbox help file for details. There is a single method of communication: TCP/IP communication.

Ethernet Communication

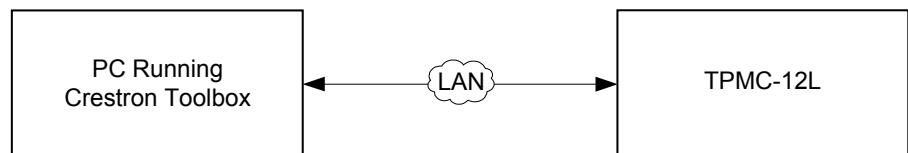

The TPMC-12L connects to PC via Ethernet:

1. Establish serial communication between TPMC-12L and PC.
2. Enter the IP address, IP mask and default router of the TPMC-12L via the Crestron Toolbox (**Functions | Ethernet Addressing**); otherwise leave DHCP enabled. (The unit ships with DHCP enabled.)
3. Confirm Ethernet connections between TPMC-12L and PC. If connecting through a hub or router, use CAT5 straight through cables with 8-pin RJ-45 connectors. Alternatively, use a CAT5 crossover cable to connect the two **LAN** ports directly without using a hub or router.
4. Use the Address Book in Crestron Toolbox to create an entry for the TPMC-12L with the TPMC-12L's TCP/IP communication parameters.
5. Display the "System Info" window (click the **i** icon) and select the TPMC-12L entry.

Programs, Projects and Firmware

Program, project or firmware files may be distributed from programmers to installers or from Crestron to dealers. Firmware upgrades are available from the Crestron Web site as new features are developed after product releases. One has the option to upload programs and projects via the programming software or to upload and upgrade via the Crestron Toolbox. For details on uploading and upgrading, refer to the SIMPL Windows help file, VT Pro-e help file or the Crestron Toolbox help file.

SIMPL Windows

If a SIMPL Windows program is provided, it can be uploaded to the control system using SIMPL Windows or Crestron Toolbox.

VT Pro-e

Upload the VT Pro-e file to the touch screen using VT Pro-e or Crestron Toolbox.

Firmware

Check the Crestron Web site to find the latest firmware. (New users may be required to register to obtain access to certain areas of the site, including the FTP site.)

Upgrade TPMC-12L firmware via Crestron Toolbox.

1. Establish communication with the TPMC-12L and display the “System Info” window.
2. Select **Functions | Firmware...** to upgrade the TPMC-12L firmware.

NOTE: Use an Ethernet connection for loading programs, projects or firmware.

Program Checks

Actions that can be performed on the TPMC-12L vary depending on whether it is connected via Cresnet or Ethernet.

Cresnet Connections

For Cresnet connections, using Crestron Toolbox, display the network device tree (**Tools | Network Device Tree View**) to show all network devices connected to the control system. Right-click on the TPMC-12L to display actions that can be performed on the TPMC-12L.

Ethernet Connections

For Ethernet connections, display the “System Info window (click the  icon) and select the **Functions** menu to display actions that can be performed on the TPMC-12L.

Be sure to use Crestron Toolbox to create the TPMC-12L IP table.

1. Select **Functions | IP Table Setup**.
2. Add, modify or delete entries in the IP table. The TPMC-12L can have only one IP table entry.
3. A defined IP table can be saved to a file or sent to the device.

Edit the control system’s IP table to include an entry for the TPMC-12L. The entry should list the TPMC-12L’s IP ID (specified on the TPMC-12L’s IP table) and the internal gateway IP address 127.0.0.1.

Restore

The `restore` console command will restore the TPMC-12L to its original factory default settings and will also restore the original version of the firmware.

NOTE: Use of the `restore` console command will require all service packs to be re-installed as well.

Operation

MediaMarker

Crestron's MediaMarker software is used to create, organize and save presentations. A presenter can devise an entire lecture or demonstration and save it to the notebook. At the presenter's discretion, the audience may view the presentation complete with annotation in real-time.

MediaMarker can be used with the TPMC-12L or on a personal computer.

In addition to containing the tools required for object creation, MediaMarker can import graphics and text from many other applications. Importable objects include: html, jpg, bmp, png and tif.

MediaMarker projects can be saved to and retrieved from a disk or a "notebook" (Export and Import functions in the **File** menu).

File | Export Project – Archives the project into one file.

File | Import Project – Opens and extracts all files from a previously exported project into an active folder.

NOTE: When saving a project, the background images are stored as external graphic files. The graphic file type (html, jpg, bmp, png and tif) can be set within **Edit | Preferences | Application Settings**.

Additional information is available in the MediaMarker help file.

Security Infrastructure

Since the TPMC-12L does not use a traditional hard drive but rather an image that is restored every time the touch screen is rebooted, any virus infection is cleared immediately after a reboot. However, using the currently available tools and techniques, Crestron has provided an infrastructure that protects against possible virus infections.

1. Executables/Scripts brought in on external media
The implementation of the TPMC-12L series has restrictions on starting any application or script. The only applications that can be started are those allowed by Crestron and these can only be started from the Crestron project.
2. Downloaded Program/Script
The browser is customized in such a way that files cannot be downloaded. The only files the browser can open are the files it has plug-ins for, such as PDF, etc. The user cannot change the options, as this dialog box has been disabled.
3. Browser Hijack and Browser vulnerability
Crestron has patched all currently known hijacks and vulnerabilities. Future updates can be downloaded from the Crestron Web site.
4. Email Viruses
There is no e-mail client installed on the TPMC-12L, so email-based viruses cannot be executed.
5. Viruses that attack web/FTP servers
The TPMC-12L does not run a web or FTP server and is therefore not listening

to port 21 or 80. The only ports the system listens to are the ports registered to Crestron.

6. Virus from other machines on the network
Since drives on the TPMC-12L can be shared on the network, it is possible that a virus can write itself to files/folders on these shares. Our recommendation therefore is to share as "Read-Only", so that viruses cannot attach themselves to files on the TPMC-12L.
7. ActiveX and Java
The TPMC-12L has ActiveX disabled and has no Java Virtual Machine installed. These applets cannot run on the TPMC-12L.

NOTE: While browsing the Internet with the TPMC-12L, clicking on a link may cause a message box titled "Restrictions" to appear that contains the text "This operation has been cancelled due to restrictions in effect on this computer. Please contact your system administrator." If this message appears, checking *Enable Pop-ups* in the "Embedded Apps" window (refer to "Embed Apps (Embedded Applications)" which starts on page 30) may correct this error. Other restrictions may also cause this error, so this may not prevent all occurrences.

Problem Solving

Troubleshooting

The following table provides corrective action for possible trouble situations. If further assistance is required, please contact a Crestron customer service representative.

TPMC-12L Troubleshooting

TROUBLE	POSSIBLE CAUSE(S)	CORRECTIVE ACTION
Touch screen does not function.	Touch screen is not communicating with the network.	Use Crestron Toolbox (via SIMPL Windows or VT Pro-e) to poll the network. Verify network connection to the touch screen.
	Touch screen is incorrectly calibrated.	Enter the setup menu or use Crestron Toolbox to initiate the calibration sequence and recalibrate. (Refer to "Touch Screen" which starts on page 21.)
Touch screen is not responding.	Incorrect network wiring.	Touch the screen to remove any message and verify correct wiring to all connectors.
	Touch screen Cresnet ID is not set to match the Net ID in the SIMPL program.	Use Crestron Toolbox to poll the network. Verify that the Cresnet ID for the touch screen is properly set to match the Net ID in the SIMPL program.
	Touch screen Cresnet ID is not unique; two or more units share the same ID.	Use Crestron Toolbox to poll the network and verify that each ID is used only once.
Touch screen display is dark.	Standby timeout has elapsed.	Touch the screen to reactivate.
	Screen brightness is improperly set.	Adjust screen brightness from the setup menu. (Refer to "Setup Menu Details" which starts on page 18.)
Unexpected response from the touch screen.	Touch screen is incorrectly calibrated.	Enter the setup menu or use Crestron Toolbox to initiate the calibration sequence and recalibrate. (Refer to "Touch Screen" which starts on page 21.)

(Continued on following page)

TPMC-12L Troubleshooting (Continued)

TROUBLE	POSSIBLE CAUSE(S)	CORRECTIVE ACTION
Video window touch screen has no display.	Improper video connection.	Verify proper connections on the touch screen.
	Incorrect video cable used.	Verify that the correct video cable is being used.
	Incorrect video format selection.	Select the proper video input configuration in the touch screen configuration setup menu. (Refer to "Video" which starts on page 25.)
	Incorrect VT Pro-e project file loaded.	Make sure that video window object resides in project, re-compile and reload.
Communications via the LAN port is not functioning.	Improper Ethernet connection (IEC).	Verify proper connection at touch screen LAN port.
	Incorrect touch screen selected in SIMPL Windows.	Select "Touchpanel (Ethernet)" instead of "Touchpanel (Cresnet)".
	Another device set to the same IP address.	Obtain new touch screen static IP address.
	Possible bad port on the hub.	Use crossover cable to connect directly to the Ethernet port on a PC and ping the IP address of the touch screen to confirm communication. If it is good, confirm hub port by testing with another Ethernet device.

Check Network Wiring

Use the Right Wire

In order to ensure optimum performance over the full range of your installation topology, use Crestron Certified Wire only. Failure to do so may incur additional charges if support is required to identify performance deficiencies because of using improper wire.

Calculate Power

CAUTION: Use only Crestron power supplies for Crestron equipment. Failure to do so could cause equipment damage or void the Crestron warranty.

CAUTION: Provide sufficient power to the system. Insufficient power can lead to unpredictable results or damage to the equipment. Please use the Crestron Power Calculator to help calculate how much power is needed for the system (www.crestron.com/calculators).

When calculating the length of wire for a particular Cresnet run, the wire gauge and the Cresnet power usage of each network unit to be connected must be taken into consideration. Use Crestron Certified Wire only. If Cresnet units are to be daisy-chained on the run, the Cresnet power usage of each network unit to be daisy-chained must be added together to determine the Cresnet power usage of the entire chain. If the unit is home-run from a Crestron system power supply network port, the Cresnet power usage of that unit is the Cresnet power usage of the entire run. The wire gauge and the Cresnet power usage of the run should be used in the following equation to calculate the cable length value on the equation's left side.

Cable Length Equation

$$L < \frac{40,000}{R \times P}$$

Where: L = Length of run (or chain) in feet
 R = 6 Ohms (Crestron Certified Wire: 18 AWG (0.75 mm²))
 or 1.6 Ohms (Cresnet HP: 12 AWG (4 mm²))
 P = Cresnet power usage of entire run (or chain)

Make sure the cable length value is less than the value calculated on the right side of the equation. For example, a Cresnet run using 18 AWG Crestron Certified Wire and drawing 20 watts should not have a length of run more than 333 feet (101 meters). If Cresnet HP is used for the same run, its length could extend to 1250 feet (381 meters).

NOTE: All Crestron certified Cresnet wiring must consist of two twisted pairs. One twisted pair is the +24V conductor and the GND conductor and the other twisted pair is the Y conductor and the Z conductor.

Strip and Tin Wire

When daisy-chaining Cresnet units, strip the ends of the wires carefully to avoid nicking the conductors. Twist together the ends of the wires that share a pin on the network connector and tin the twisted connection. Apply solder only to the ends of the twisted wires. Avoid tinning too far up the wires or the end becomes brittle. Insert the tinned connection into the Cresnet connector and tighten the retaining screw. Repeat the procedure for the other three conductors.

Add Hubs

Use of a Cresnet Hub/Repeater (CNXHUB) is advised whenever the number of Cresnet devices on a network exceeds 20 or when the combined total length of Cresnet cable exceeds 3000 feet (914 meters).

Reference Documents

The latest version of all documents mentioned within the guide can be obtained from the Crestron Web site (www.crestron.com/manuals).

List of Related Reference Documents

DOCUMENT TITLE
2-Series Control Systems Reference Guide
BB-12L Back Box Kit
CAT5 Wiring Reference Guide
Crestron e-Control Reference Guide
MediaManager Applications Guide
MMK-12L and WMKM-12L Mud Ring Mount Kit
PMK-12L Pre-Construction Mount Kit
QM-TX QuickMedia Transmitter
RMK-12L Rack Mount Kit
TMK-12L and WMKT-12L Trim Ring Mount Kit
TPMC-CH-IMC Interface Module

Further Inquiries

If you cannot locate specific information or have questions after reviewing this guide, please take advantage of Crestron's award winning customer service team by calling Crestron at 1-888-CRESTRON [1-888-273-7876]. For assistance in your region, please refer to the Crestron Web site (www.crestron.com/offices) for a listing of Crestron worldwide offices.

You can also log onto the online help section of the Crestron Web site (www.crestron.com/onlinehelp) to ask questions about Crestron products. First-time users will need to establish a user account to fully benefit from all available features.

Future Updates

As Crestron improves functions, adds new features and extends the capabilities of the TPMC-12L, additional information may be made available as manual updates. These updates are solely electronic and serve as intermediary supplements prior to the release of a complete technical documentation revision.

Check the Crestron Web site periodically for manual update availability and its relevance. Updates are identified as an "Addendum" in the Download column.

Return and Warranty Policies

Merchandise Returns / Repair Service

1. No merchandise may be returned for credit, exchange or service without prior authorization from Crestron. To obtain warranty service for Crestron products, contact an authorized Crestron dealer. Only authorized Crestron dealers may contact the factory and request an RMA (Return Merchandise Authorization) number. Enclose a note specifying the nature of the problem, name and phone number of contact person, RMA number and return address.
2. Products may be returned for credit, exchange or service with a Crestron Return Merchandise Authorization (RMA) number. Authorized returns must be shipped freight prepaid to Crestron, 6 Volvo Drive, Rockleigh, N.J. or its authorized subsidiaries, with RMA number clearly marked on the outside of all cartons. Shipments arriving freight collect or without an RMA number shall be subject to refusal. Crestron reserves the right in its sole and absolute discretion to charge a 15% restocking fee plus shipping costs on any products returned with an RMA.
3. Return freight charges following repair of items under warranty shall be paid by Crestron, shipping by standard ground carrier. In the event repairs are found to be non-warranty, return freight costs shall be paid by the purchaser.

Crestron Limited Warranty

Crestron Electronics, Inc. warrants its products to be free from manufacturing defects in materials and workmanship under normal use for a period of three (3) years from the date of purchase from Crestron, with the following exceptions: disk drives and any other moving or rotating mechanical parts, pan/tilt heads and power supplies are covered for a period of one (1) year; touch screen display and overlay components are covered for 90 days; batteries and incandescent lamps are not covered.

This warranty extends to products purchased directly from Crestron or an authorized Crestron dealer. Purchasers should inquire of the dealer regarding the nature and extent of the dealer's warranty, if any.

Crestron shall not be liable to honor the terms of this warranty if the product has been used in any application other than that for which it was intended or if it has been subjected to misuse, accidental damage, modification or improper installation procedures. Furthermore, this warranty does not cover any product that has had the serial number altered, defaced or removed.

This warranty shall be the sole and exclusive remedy to the original purchaser. In no event shall Crestron be liable for incidental or consequential damages of any kind (property or economic damages inclusive) arising from the sale or use of this equipment. Crestron is not liable for any claim made by a third party or made by the purchaser for a third party.

Crestron shall, at its option, repair or replace any product found defective, without charge for parts or labor. Repaired or replaced equipment and parts supplied under this warranty shall be covered only by the unexpired portion of the warranty.

Except as expressly set forth in this warranty, Crestron makes no other warranties, expressed or implied, nor authorizes any other party to offer any warranty, including any implied warranties of merchantability or fitness for a particular purpose. Any implied warranties that may be imposed by law are limited to the terms of this limited warranty. This warranty statement supersedes all previous warranties.

Crestron software, including without limitation, product development software and product operating system software is licensed to Crestron dealers and Crestron Authorized Independent Programmers (CAIPs) under a limited non-exclusive, non-transferable license pursuant to a separate end-user license agreement. The terms of this end user license agreement can be found on the Crestron Web site at www.crestron.com/legal/software_license_agreement.

Microsoft[®] Windows XP[®] Embedded End User License Agreement

- You have acquired a device (“DEVICE”) that includes software licensed by Crestron Electronics from Microsoft Licensing Inc. or its affiliates (“MS”). Those installed software products of MS origin, as well as associated media, printed materials, and “online” or electronic documentation (“SOFTWARE”), are protected by international intellectual property laws and treaties. The SOFTWARE is licensed, not sold. All rights reserved.
- IF YOU DO NOT AGREE TO THIS END USER LICENSE AGREEMENT (“EULA”), DO NOT USE THE DEVICE OR COPY THE SOFTWARE. INSTEAD, PROMPTLY CONTACT CRESTRON ELECTRONICS FOR INSTRUCTIONS ON RETURN OF THE UNUSED DEVICE(S) FOR A REFUND. **ANY USE OF THE SOFTWARE, INCLUDING BUT NOT LIMITED TO USE ON THE DEVICE, WILL CONSTITUTE YOUR AGREEMENT TO THIS EULA (OR RATIFICATION OF ANY PREVIOUS CONSENT).**
- **GRANT OF SOFTWARE LICENSE.** This EULA grants you the following license:
 - You may use the SOFTWARE only on the DEVICE.
 - **NOT FAULT TOLERANT.** THE SOFTWARE IS NOT FAULT TOLERANT. CRESTRON ELECTRONICS HAS INDEPENDENTLY DETERMINED HOW TO USE THE SOFTWARE IN THE DEVICE, AND MS HAS RELIED UPON CRESTRON ELECTRONICS TO CONDUCT SUFFICIENT TESTING TO DETERMINE THAT THE SOFTWARE IS SUITABLE FOR SUCH USE.
 - NO WARRANTIES FOR THE SOFTWARE. **THE SOFTWARE IS PROVIDED “AS IS” AND WITH ALL FAULTS. THE ENTIRE RISK AS TO SATISFACTORY QUALITY, PERFORMANCE, ACCURACY, AND EFFORT (INCLUDING LACK OF NEGLIGENCE) IS WITH YOU. ALSO, THERE IS NO WARRANTY AGAINST INTERFERENCE WITH YOUR ENJOYMENT OF THE SOFTWARE OR AGAINST INFRINGEMENT.** IF YOU HAVE RECEIVED ANY WARRANTIES REGARDING THE DEVICE OR THE SOFTWARE, THOSE WARRANTIES DO NOT ORIGINATE FROM, AND ARE NOT BINDING ON, MS.
 - No Liability for Certain Damages. **EXCEPT AS PROHIBITED BY LAW, MS SHALL HAVE NO LIABILITY FOR ANY INDIRECT, SPECIAL, CONSEQUENTIAL OR INCIDENTAL DAMAGES ARISING FROM OR IN CONNECTION WITH THE USE OR PERFORMANCE OF THE SOFTWARE. THIS LIMITATION SHALL APPLY EVEN IF ANY REMEDY FAILS OF ITS ESSENTIAL PURPOSE. IN NO EVEN SHALL MS BE LIABLE FOR ANY AMOUNT IN EXCESS OF U.S. TWO HUNDRED FIFTY DOLLARS (U.S. \$250.00).**
 - **Limitations on Reverse Engineering, Decompilation, and Disassembly.** You may not reverse engineer, decompile, or disassemble the SOFTWARE, except and only to the extent that such activity is expressly permitted by applicable law notwithstanding this limitation.
 - **SOFTWARE TRANSFER ALLOWED BUT WITH RESTRICTIONS.** You may permanently transfer rights under this EULA only as part of a permanent sale or transfer of the Device, and only if the recipient agrees to this EULA. If the SOFTWARE is an upgrade, any transfer must also include all prior versions of the SOFTWARE.
 - **EXPORT RESTRICTIONS.** You acknowledge that SOFTWARE is subject to U.S. export jurisdiction. You agree to comply with all applicable international and national laws that apply to the SOFTWARE, including the U.S. Export Administration Regulations, as well as end-user, end-use and destination restrictions issued by U.S. and other governments. For additional information, see www.microsoft.com/exporting.
- **Limited Use of Particular SOFTWARE Services.** Provided that the DEVICE continues to comply with the terms of the “Restricted Functionality” paragraph below, without limiting the number of computers or other electronic devices that might connect to the DEVICE to access or utilize other software or SOFTWARE services on the DEVICE, you may permit a maximum of ten (10) computers or other electronic devices to connect to the DEVICE to utilize the services of the SOFTWARE for (a) file and print services, (b) Internet information services, and/or (c) remote access (including connection sharing). The ten (10) connections maximum includes any indirect connections made through “multiplexing” or other software or hardware which pools or aggregates connections.
- If you use the DEVICE to access or utilize the services or functionality of Microsoft Windows Server products (such as Microsoft Windows NT Server 4.0 (all editions) or Microsoft Windows 2000 Server (all editions)), or use the DEVICE to permit workstation or computing devices to access or utilize the services or functionality of Microsoft Windows Server products, you may be required to obtain a Client Access License for the DEVICE and/or each such workstation or computing device. Please refer to the End-User License Agreement for your Microsoft Windows Server product for additional information.
- **Restricted Deployment.** The SOFTWARE is not designed or intended for use or resale in hazardous environments requiring fail-safe performance, such as in the operation of nuclear facilities, aircraft navigation or communication systems, air traffic control, or other devices or systems in which a malfunction of the SOFTWARE would result in foreseeable risk of injury or death to the operator of the device or system, or to others.
- **Restricted Functionality.** You are licensed to use the SOFTWARE to provide only the limited functionality (specific tasks or processes) for which the DEVICE has been designed and marketed by Crestron. This license specifically prohibits any other use of the SOFTWARE, or inclusion of additional software programs or functions, on the DEVICE. Subject to the terms of the “Limited Use of Particular Services” paragraph above, you may use the SOFTWARE on the DEVICE to interact with other computers or electronic devices.
- **Maximum Number of Processors.** The SOFTWARE may not be used by more than two (2) processors at any one time on the DEVICE.

- **Remote Boot Feature.** Your DEVICE may be enabled with a Remote Boot feature which includes Remote Boot Installation Services tool. You may use the Remote Boot Installation Services tool only to deploy the SOFTWARE to one or more DEVICES on which you are licensed to run the SOFTWARE (i.e. DEVICES to which the appropriate Certificate of Authenticity is affixed). Please refer to the DEVICE documentation, if provided with your DEVICE, or contact Crestron for additional information.
- **Security Updates.** Content providers are using the digital rights management technology (“Microsoft DRM”) contained in this SOFTWARE to protect the integrity of their content (“Secure Content”) so that their intellectual property, including copyright, in such content is not misappropriated. Owners of such Secure Content (“Secure Content Owners”) may, from time to time, request MS, Microsoft Corporation, or their subsidiaries to provide security related updates to the Microsoft DRM components of the SOFTWARE (“Security Updates”) that may affect your ability to copy, display, and/or play Secure Content through Microsoft software or third-party applications that utilize Microsoft DRM. You therefore agree that, if you elect to download a license from the Internet, which enables our use of Secure Content, MS, Microsoft Corporation, or their subsidiaries may, in conjunction with such license, also download onto your DEVICE such Security Updates that a Secure Content Owner has requested that MS, Microsoft Corporation, or their subsidiaries distribute. MS, Microsoft Corporation, or their subsidiaries will not retrieve any personally identifiable information, or any other information, from your DEVICE by downloading such Security Updates.
- **NetMeeting/Remote Assistance/Remote Desktop Features.** The SOFTWARE may contain NetMeeting, Remote Assistance, and Remote Desktop technologies that enable the SOFTWARE or other applications installed on the Device to be used remotely between two or more computing devices, even if the SOFTWARE or application is installed on only one Device. You may use NetMeeting, Remote Assistance, and Remote Desktop with all Microsoft products; provided, however, use of these technologies with certain Microsoft products may require an additional license. For both Microsoft products and non-Microsoft products, you should consult the license agreement accompanying the applicable product or contact the applicable licensor to determine whether use of NetMeeting, Remote Assistance, or Remote Desktop is permitted without an additional license.
- **Consent to Use of Data.** You agree that MS, Microsoft Corporation, and their affiliates may collect and use technical information gathered in any manner as part of product support services related to the SOFTWARE. MS, Microsoft Corporation, and their affiliates may use this information solely to improve their products or to provide customized services or technologies to you. MS, Microsoft Corporation, and their affiliates may disclose this information to others, but not in a form that personally identifies you.
- **Internet Gaming/Update Features.** If the SOFTWARE provides, and you choose to utilize, the Internet gaming or update features within the SOFTWARE, it is necessary to use certain computer system, hardware, and software information to implement the features. By using these features, you explicitly authorize MS, Microsoft Corporation, and/or their designated agent to use this information solely to improve their products or to provide customized services or technologies to you. MS or Microsoft Corporation may disclose this information to others, but not in a form that personally identifies you.
- **Internet –Based Services Components.** The SOFTWARE may contain components that enable and facilitate the use of certain Internet-based services. You acknowledge and agree that MS, Microsoft Corporation, or their affiliates may automatically check the version of the SOFTWARE and/or its components that you are utilizing and may provide upgrades or supplements to the SOFTWARE that may be automatically downloaded to your Device.
- **Links to Third-Party Sites.** The SOFTWARE may provide you with the ability to link to third-party sites through the use of the SOFTWARE. The third-party sites are not under the control of MS, Microsoft Corporation, or their affiliates. Neither MS nor Microsoft Corporation nor their affiliates are responsible for (i) the contents of any third-party sites, any links contained in third-party sites, or any changes or updates to third-party sites, or (ii) webcasting or any other form of transmission received from any third-party sites. If the SOFTWARE provides links to third-party sites, those links are provided to you only as a convenience, and the inclusion of any link does not imply an endorsement of the third-party site by MS, Microsoft Corporation, or their affiliates.
- **Additional Software/Services.** The SOFTWARE may permit Crestron, MS, Microsoft Corporation, or their affiliates to provide or make available to you SOFTWARE updates, supplements, add-on components, or Internet-based services components of the SOFTWARE after the date you obtain your initial copy of the SOFTWARE (“Supplemental Components”).
 - If Crestron provides or makes available to you Supplemental Components and no other EULA terms are provided along with the Supplemental Components, then the terms of this EULA shall apply.
 - If MS, Microsoft Corporation, or their affiliates make available Supplemental Components, and no other EULA terms are provided, then the terms of this EULA shall apply, except that the MS, Microsoft Corporation, or affiliate entity providing the Supplemental Component(s) shall be the licensor of the Supplemental Component(s).

Crestron, MS, Microsoft Corporation, and their affiliates reserve the right to discontinue any Internet-based services provided to you or made available to you through the use of the SOFTWARE.

This EULA does not grant you any rights to use the Windows Media Format Software Development Kit (“WMFSDK”) components contained in the SOFTWARE to develop a software application that uses Windows Media technology. If you wish to use the WMFSDK to develop such an application, visit <http://msdn.Microsoft.com/workshop/imedia/windowsmedia/sdk/wmsdk.asp>, accept a separate license for the WMFSDK, download the appropriate WMFSDK, and install it on your system.



Crestron Electronics, Inc.
15 Volvo Drive Rockleigh, NJ 07647
Tel: 888.CRESTRON
Fax: 201.767.7576
www.crestron.com

Operations Guide – DOC. 6686C
(2020821)
12.11
Specifications subject to
change without notice.