

TEST REPORT

This laboratory is accredited by Voluntary Control Council for Interference and National Voluntary Laboratory Accreditation Program.

The tests reported herein have been performed in accordance with its terms of accreditation.

Test Report No. : LR500171707E
Issue Date : July 14, 2017
Applied Standard : VCCI RULES AND REGULATIONS OF CLASS A
(V-3 / 2015.04 Normative ANNEX 1:Technical Requirements)
Applicant Name : Crestron Electronics. Inc.
Product Name : Cameo® Keypad, Standard Mount
Model Name : C2N-CBD-P
Brand : -
Serial Number : -

This test result only responds to the tested sample. It is not allowed to copy this report even partly without the allowance of the test laboratory. The report must not be used by the client to claim product certification, approval, or endorsement by NVLAP, NIST, or any agency of the Federal Government.



NVLAP LAB CODE 200723-0

TABLE OF CONTENTS

★ ★ ★ ★ ★ ★ ★ ★ ★ ★ ★ ★ ★ ★ ★ ★

<u>Text</u>	<u>Page</u>
Contents -----	2
LTA Certification -----	3
General Information -----	5
Brief Information -----	6
Test site description -----	9
Test Procedure -----	11
List of test equipment used for the test -----	14
Radiated disturbance measurement ----- Result & Graph	15
Conducted disturbance measurement ----- Result & Graph	17
Conclusions -----	21
Photograph of the measurements -----	22
Photograph of the EUT -----	24

★ ★ ★ ★ ★ ★ ★ ★ ★ ★ ★ ★ ★ ★ ★ ★

LTA Certification

Client / Manufacturer

Company name : Crestron Electronics. Inc.
Address : 15 Volvo Drive, Rockleigh, NJ 07647, United States
Telephone / Facsimile : +00-800-237-2041 Ext:12345

Factory

Company name : Crestron Electronics. Inc.
Address : 15 Volvo Drive, Rockleigh, NJ 07647, United States

Equipment Under Test (EUT)

Trade name : -
Product name : Cameo® Keypad, Standard Mount
Model name : C2N-CBD-P
Variant model name : C2N-CBD-P-A-S, C2N-CBD-P-AT, C2N-CBD-P-B-S, C2N-CBD-P-B-T,
C2N-CBD-PBRN-S, C2N-CBD-P-DA-S, C2N-CBD-P-DSKT,
C2N-CBD-P-GRY-S, C2N-CBD-P-IVR-S, C2N-CBD-P-LAT-T,
C2N-CBD-P-W-S, C2N-CBD-P-W-T
Serial number : -
Intended environment : Residential area
Date of receipt : June 21, 2017
EUT condition : Pre-production, not damaged
Interface Ports : NET
Power Source : DC 24 V
Crystal/Oscillator(s) : -
Firmware version : XXXX

Model Description

- None

Test Performed

Test started & completed : July 11-July 13, 2017
Location : LTA Co., Ltd.

*** To be continued next page ***

Test Specification

Purpose of the test : Compliance test to the following standard
Applied standard : VCCI RULES AND REGULATIONS OF CLASS A
(V-3 / 2015.04 Normative ANNEX 1:Technical Requirements)

Test Results

Measurement	Results*	Test method
Radiated disturbance	Complies	V-3/2015.04
Radiated disturbance at above 1 GHz	Not Applicable	V-3/2015.04
Conducted disturbance	Complies	V-3/2015.04
Conducted disturbances at telecommunication ports	Not Applicable	V-3/2015.04

* : The compliance statement is based on nominal value only.

Laboratory's Certificate

Report number : LR500171707E
Issue date : July 14, 2017

This test report is issued under the authority of:



Yong-Cheol, Wang, Manager

The test was supervised by:



Min gi Kang, Test Engineer

General information's

Purpose

This document is based on the Electromagnetic Interference (EMI) tests performed on the “C2N-CBD-P”.
 The measurements were performed according to the measurement procedure described in VCCI RULES AND REGULATIONS OF CLASS A V-3 / 2015.04 Normative ANNEX 1:Technical Requirements)

Test Performed

Company name : LTA Co., Ltd.
 Address : 243, Jubug-ri, Yangji-Myeon, Cheoin-gu, Youngin-Si, Kyunggi-Do, Korea. 449-822
 Telephone / Facsimile : +82-31-323-6008 / +82-31-323-6010

Measurement uncertainty

Radiated disturbance	(30 – 1 000 MHz)	:	+4.52 [dB] , -4.43 [dB] (k=2)
Radiated disturbance at above 1 GHz	(1 GHz – 6 GHz)	:	+3.0 [dB] , -3.0 [dB] (k=2)
Conducted disturbance	(0.15 – 30 MHz)	:	+0.11 [dB] , -0.11 [dB] (k=2)
Conducted disturbances at telecommunication ports	(0.15 – 30 MHz)	:	+0.11 [dB] , -0.11 [dB] (k=2)

The coverage factor k=2 yields approx. a 95% level of confidence for near-normal distribution typical of most measurement results.

Accredited agencies

LTA Co., Ltd. Is approved to perform EMC testing by the following agencies:

Agency	Country	Accreditation No.	Validity	Reference
NVLAP	U.S.A	200723-0	2017-09-30	ECT accredited Lab.
RRA	KOREA	KR0049	-	EMC accredited Lab.
FCC	U.S.A	649054	2019-04-13	FCC CAB
VCCI	JAPAN	R-2133(10 m), C-2307	2017-06-21	VCCI registration
VCCI	JAPAN	T-2009	2017-12-23	VCCI registration
VCCI	JAPAN	G-847	2018-12-13	VCCI registration
IC	CANADA	5799A-1	2019-11-07	IC filing

Brief Information

1-1 Test Summary

Parameter	Applied Standard	Status (note 1)
I. Emission		
Radiated disturbance	V-3/2015.04	C
Radiated disturbance at above 1 GHz	V-3/2015.04	NA
Conducted disturbance	V-3/2015.04	C
Conducted disturbances at telecommunication ports	V-3/2015.04	NA
Note 1: C=Complies NC=Not Complies NT=Not Tested NA=Not Applicable		
* The data in this test report are traceable to the national or international standards.		

Frequency range to be scanned:

0.15 MHz - 30 MHz as conducted measurement

30 MHz – 1 000 MHz (1 GHz) as radiated measurement

Bandwidth:

Measured by the CISPR quasi-peak function Bandwidth is 10 kHz in the frequency 0.15 MHz to 30 MHz, 120 kHz in the frequency 30 MHz to 1,000 MHz.

A sample calculation:

COR. F (correction factor)= Antenna factor + Cable loss- Amp.gain- Distance correction

Emission Level= meter reading + COR.F

1-2 Operating Mode of the EUT

The tests have been conducted with the following operational mode(s) of the EUT.

Name of mode in the report	Description
----------------------------	-------------

Operating mode	: -
----------------	-----

1-3 Modification

- None

1-4 List of EUT and accessory

EUT				
Category	Model Name	Serial No.	Manufacturer	Remarks
Cameo® Keypad, Standard Mount	C2N-CBD-P	N/A	Crestron Electronics. Inc.	-
ACCESSORY				
Category	Model Name	Serial No.	Manufacturer	Remarks
Dual-Technology Occupancy Sensor with Cresnet®	GLS-ODT-C-CN	N/A	Crestron Electronics. Inc.	-
DIN Rail Cresnet® Distribution Hub	DIN-HUB	N/A	Crestron Electronics. Inc.	-
DIN Rail 60 Watt Cresnet® Power Supply	DIN-PWS60	N/A	Crestron Electronics. Inc.	-

1-5 Cable List

Cable List				
Cable Type	Length (m)	Shielding (Cable/backshell)	Remarks	
			From	to
DIN Rail Cresnet® Distribution Hub	1.5	NO/NO	NET C	NET
DIN Rail 60 Watt Cresnet® Power Supply	1.0	NO/NO	NET	NET HOST
DIN Rail 60 Watt Cresnet® Power Supply	1.5	NO/NO	NET	INPUT
Dual-Technology Occupancy Sensor with Cresnet®	1.0	NO/NO	NET	NET C
AC Power Source	1.2	NO/NO	3 Pin AC Line	AC IN

1-6 Block diagram of the EUT test / Operating mode

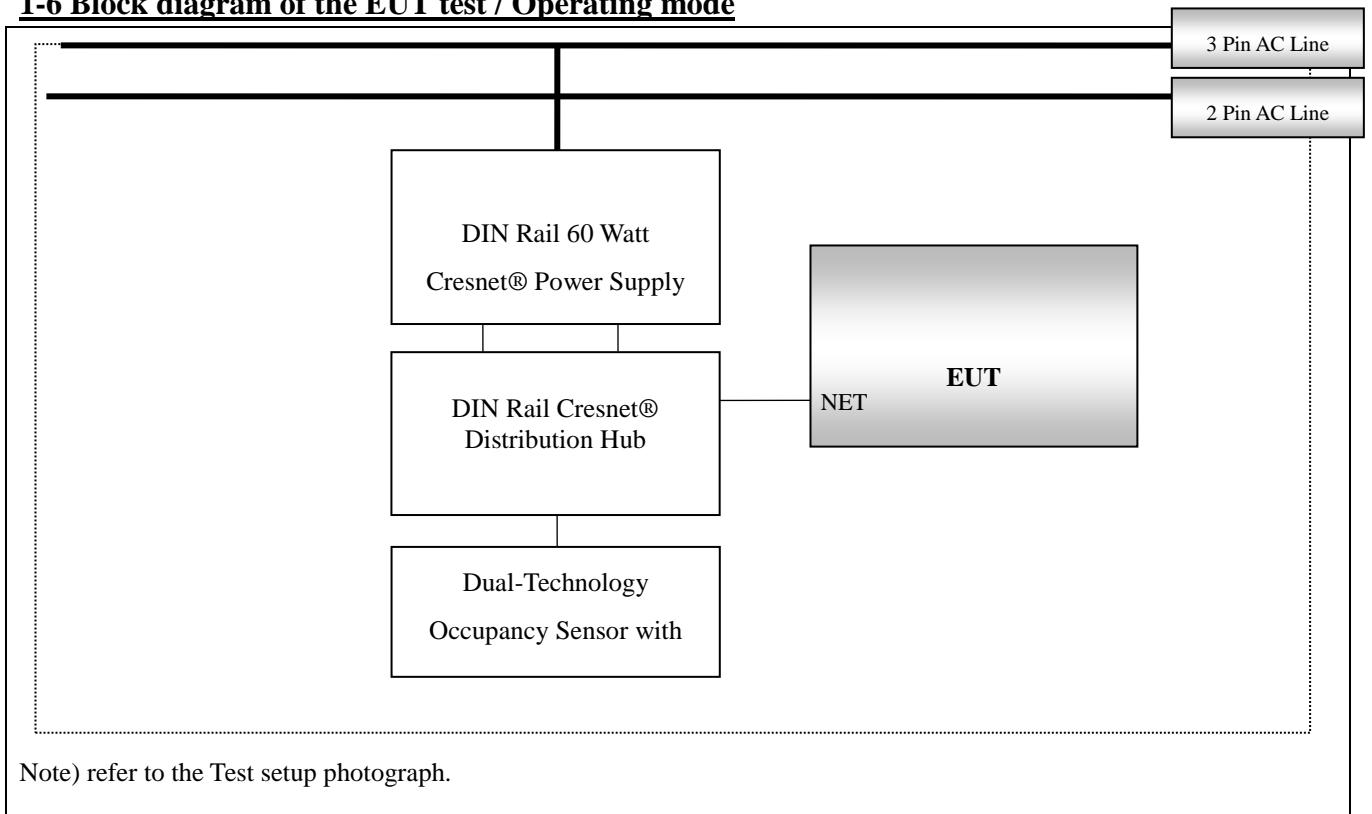

2- Test Site Description

1-Facility

All the testing facilities are periodically serviced as a daily check for equipment and cables systems, an every 6 months facility check for the facilities and a monthly check and annual calibration for testing equipment according to ISO/IEC 17025. All the testing facilities are used as the same specifications shown below. There are descriptions both for radiated disturbance measurement and conducted disturbance measurement conformed by VCCI RULES AND REGULATIONS OF CLASS B (V-3 / 2015.04 Normative ANNEX1:Technical Requirements) telecommunication ports CONDUCTED EMISSIONS TESTING

2-1 Radiated Disturbance Measurement

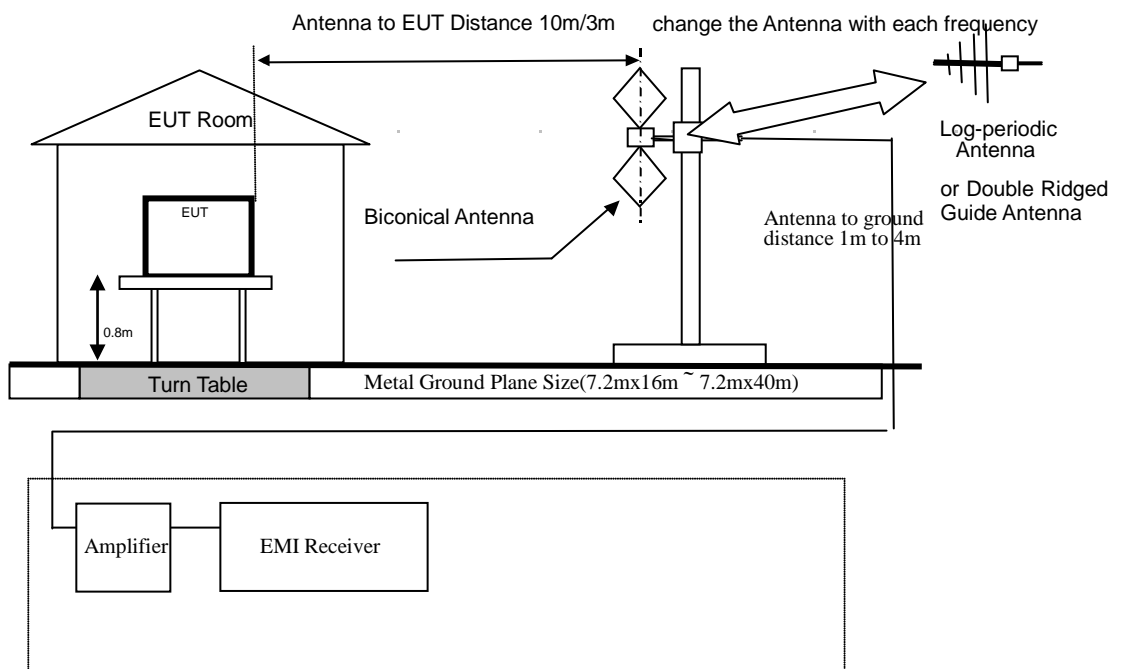

2-2 Conducted Disturbance Measurement

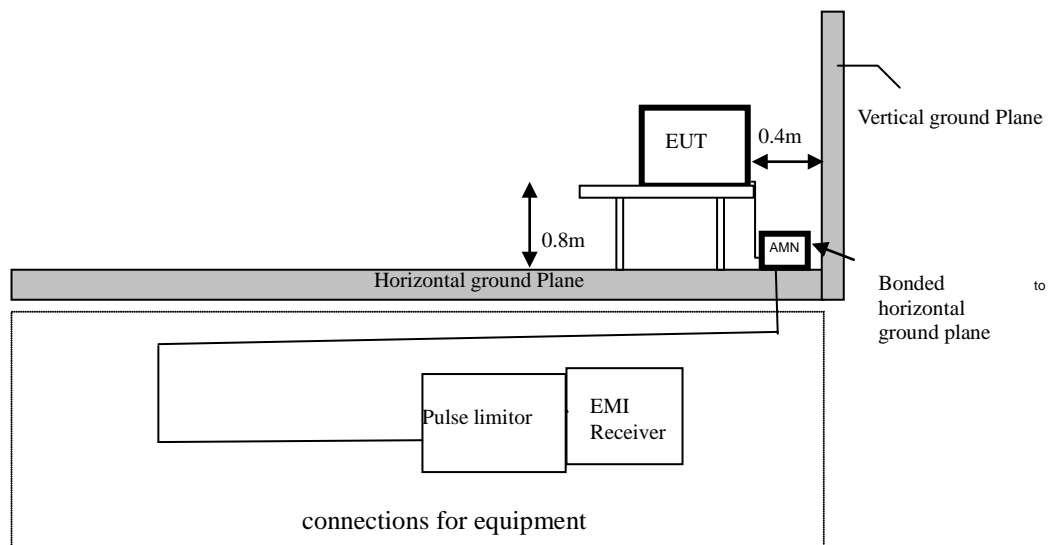

2-3 Conducted Disturbances at telecommunication ports

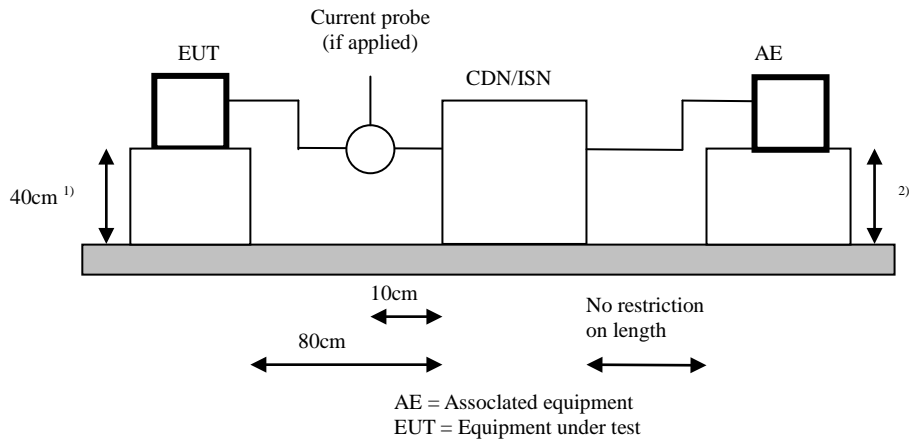
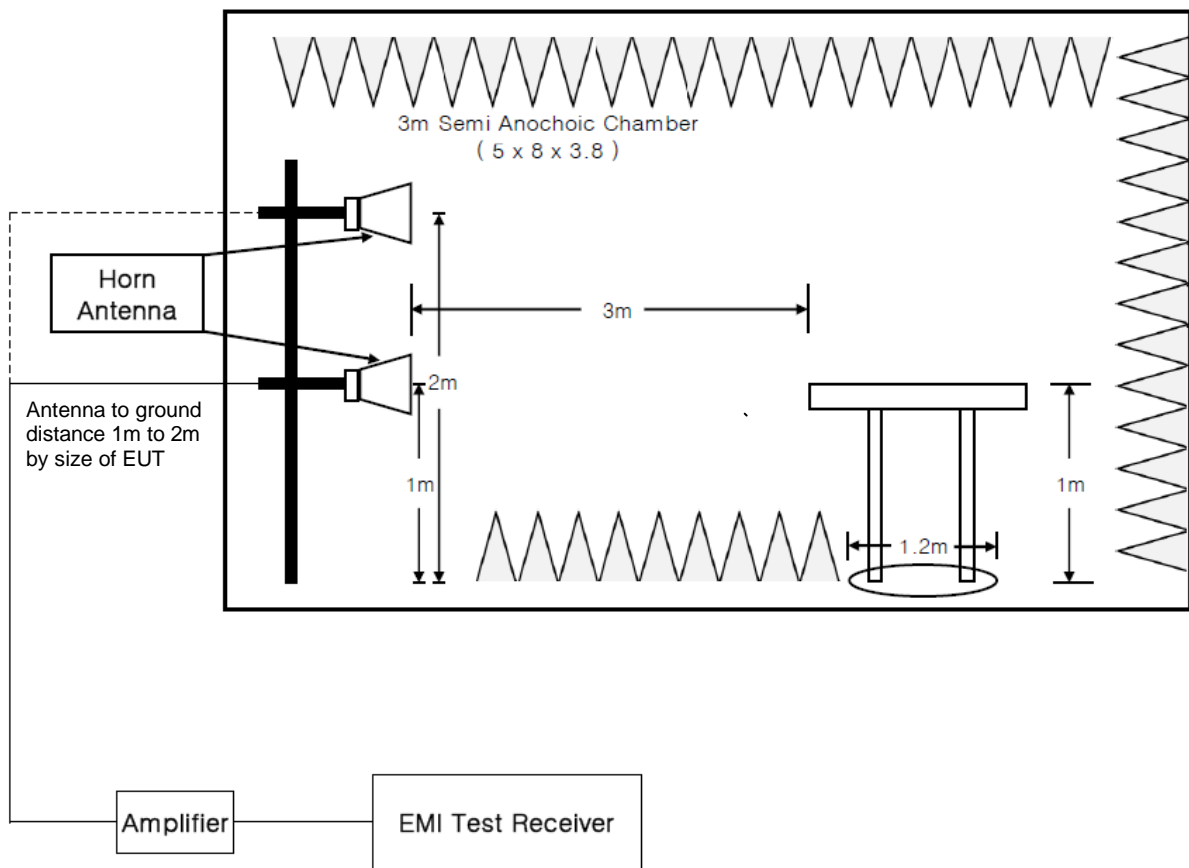

Diagram 3 : Telecom Port Conducted Emissions Test Setup

2-4 Radiated Disturbance at above 1 GHz



3- Test Procedure

3-1 Radiated Disturbance Measurements

- Test site is met the requirements of VCCI RULES AND REGULATIONS OF CLASS A (V-3 / 2015.04 Normative ANNEX1:Technical Requirements) and the distance between the EUT and the antenna is adjusted 3 m or 10m.
- The turntable can be rotated 360 degrees.
- The antenna can be adjusted between 1m and 4m in height above the ground.
- The EUT is placed on the non-conducting table with 0.8m height on the turntable.
- Measurements are carried out using a spectrum analyzer with peak detectors (100kHz bandwidth) and an EMI receiver with quasi-peak detectors(120 kHz bandwidth).
- Refer to the list of test equipment used for the test.
- Biconical antenna and logperiodic antenna are used as wideband antenna.
- The Biconical antenna is used in the frequency range of 30 MHz to 300 MHz and the Logperiodic antenna is used in the frequency range of 300 MHz to 1 GHz.
- A variable attenuator is used for verifying amplifier's linearity.
- Rotating the turntable and adjusting the height of the antenna are carried out by control buttons on the console.
- Refer to "Brief Information"(page 6-9) about details of the EUT and configuration of the cables.

- Measurement is carried out by a LTA operator as manual operation.
 - searching for some of High disturbance frequency points than the other points with the following settings; bandwidth 100 kHz, frequency range 10 MHz between 30 MHz and 300 MHz and frequency range 50 MHz between 300 MHz and 1 GHz.
 - searching the worst direction with the maximum level of the disturbance wave in rotating the turntable 360 degrees at each searched frequency point.
 - setting the height of the antenna with the maximum level of the disturbance wave from 1m to 4 m.
 - reading the disturbance level by the EMI receiver with quasi-peak detectors (120 kHz bandwidth) according to VCCI RULES AND REGULATIONS OF CLASS A (V-3 / 2015.04 Normative ANNEX1:Technical Requirements)
 - measuring to vertical and horizontal polarization.
 - calculating the measurement result with the following formula or equation:
(Measurement result= measured value + antenna factor + antenna cable loss)

3-2 Conducted Disturbance Measurements

- The measurement is carried out on an open site with horizontal and metallic ground plane.
- An AMN(Artificial Mains Network) with a nominal impedance ($50 \Omega/50 \mu\text{H}$) as defined in VCCI RULES AND REGULATIONS OF CLASS A (V-3 / 2015.04 Normative ANNEX1:Technical Requirements). shall be utilized.
- The AMN is grounded on a horizontal metal ground plane.
- Measurement is carried out using a spectrum analyzer with peak detectors (10kHz bandwidth) and an EMI receiver with quasi-peak detectors and average detector. (Refer to the List of test equipment used for the test.)
- The shortest distance between the EUT and the AMN is 0.8 m.
- The EUT is placed on the non-conducting table with 0.8 m height.
- A remote switch is used for changing phases between Line (L) and Neutral (N).
- Refer to "Brief Information"(page 6-9) about details of the EUT and configuration of the cables.

- Measurement is carried out as manual operation.
 - detecting the maximized emission level using the maxhold function after setting the spectrum analyzer bandwidth 1MHz and the frequency range from 150 kHz to 1 MHz , 1 MHz to 5 MHz and 5 MHz to 30 MHz.
 - searching the maximum frequency point of the disturbance wave in each frequency range.
 - reading the disturbance level of quasi-peak, average and Line (L) and Neutral (N) in 10 kHz bandwidth by the EMI receiver.
 - calculating the measurement result with the following formula or equation.
(Result = Reading + Cor.F.)
(Margin = Limit- Result)

3-3 Conducted Disturbances at telecommunication ports Measurements

- In the range of 0.15 MHz to 30 MHz, the conducted disturbance was measured and set-up was made accordance with VCCI V-3/2015.04, CLASS A ITE.
- The EUT is placed on a non-conducting table, which is: 0.8 meters above an earth-grounded floor; 0.4 meters away from a vertical ground plane (i.e. the chamber wall); and 0.8 meter away from all other metal objects. For cables where there is no appropriate CDN / ISN available, measurement was done using a combination of current probe and capacitive voltage probe.
- Measure current with a current probe.
- Measure voltage with a capacitive probe
- Compare the measured voltage with the voltage limit.
- Compare the measured current with the current limit.
- The EUT shall meet both the voltage and current limits.

3-4 Radiated Disturbance at above 1 GHz

- Test site is met the requirements of VCCI V-3/2015.04 and the distance between the EUT and the antenna is adjusted 3 m.
 - The turntable can be rotated 360 degrees.
 - The antenna can be adjusted between 1m in height above the ground.
 - The EUT is placed on the non-conducting table with 1m height on the turntable.
 - Measurements are carried out using a EMI test receiver with peak detectors (1 MHz bandwidth) and an EMI receiver with peak and average detectors(1 MHz bandwidth).
 - Refer to the list of test equipment used for the test.
 - HORN antenna are used as wideband antenna.
 - The HORN antenna is used in the frequency range of 1 GHz to 18 GHz.
 - A variable attenuator is used for verifying amplifier's linearity.
 - Rotating the turntable and adjusting the height of the antenna are carried out by control buttons on the console.
 - Refer to "Brief Information"(page 6-9) about details of the EUT and configuration of the cables.
 - Measurement is carried out by a LTA operator as manual operation.
 - searching the worst direction with the maximum level of the disturbance wave in rotating the turntable 360 degrees at each searched frequency point.
 - setting the height of the antenna with the maximum level of the disturbance wave from 1m
 - reading the disturbance level by the EMI receiver with peak and average detectors (1 MHz bandwidth) according to ANSI C 63.4:2003.
 - measuring to vertical and horizontal polarization.
 - calculating the measurement result with the following formula or equation:
(Measurement result= measured value + antenna factor + antenna cable loss)

4- List of Equipment Used For the Tests

	Description	Model No.	Serial No.	Manufacturer	Interval	LAST Cal.
1	EMI TEST Receiver	ESR	101499	Rohde & Schwarz	1 year	Jul-17
2	Pulse Limiter	ESH3-Z2	100710	Rohde & Schwarz	1 year	Mar-17
3	DIGITAL THERMO HYGROMETER	TH-611	NONE	BODYCOM	1 year	Sep-16
4	DTV Signal Generator	MFG-100	15M2002	MFLO	1 year	Mar-17
5	Color TV Pattern Generator	PM-5518-TX	LO5333	Philips	-	-
6	LISN	ESH3-Z6	100378	Rohde & Schwarz	1 year	Sep-16
7	LISN(main)	ESH3-Z5	893045/017	Rohde & Schwarz	1 year	Mar-17
8	LISN(sub)	ENV216	100408	Rohde & Schwarz	1 year	Sep-16
9	ISN	ISN T800	27109	TESEQ	1 year	Jan-17
10	ISN	ENY81-CA6	101565	Rohde & Schwarz	1 year	Jan-17
11	CURRENT PROBE	EZ-17	100508	Rohde & Schwarz	1 year	Jan-17
12	LISN	ESH3-Z6	100378	Rohde & Schwarz	1 year	Sep-16
13	EMI TEST Receiver	ESCI7	100772	Rohde & Schwarz	1 year	Sep-16
14	Amplifier (25 dB)	8447D	2944A07974	HP	1 year	Sep-16
15	DIGITAL THERMO HYGROMETER	TESTEK-303A	TAEGUANG	-	1 year	Mar-17
16	Log.-Per. Antenna	VULP9118	9118 A 401	SCHWARZBECK	2 year	Apr-17
17	Biconical Antenna	VHA 9103	VHA 9103-2315	SCHWARZBECK	2 year	Apr-17
18	TRILOG Antenna	VULB9160	9160-3237	SCHWARZBECK	2 year	May-17
19	TRILOG Antenna	VULB9160	9160-3242	SCHWARZBECK	2 year	Jul-16
20	Amplifier (25 dB)	8449B	3008A00337	HP	1 year	Mar-17
21	Spectrum Analyzer (~ 26.5 GHz)	E4407B	MY45108946	Agilent	1 year	Mar-17
22	HORN ANTENNA	3115	114105	ETS	2 year	May-16
23	HORN ANTENNA	3115	114105	ETS	2 year	Jul-16
24	TRILOG Antenna	VULB9268	775	SCHWARZBECK	2 year	Mar-17
25	HORN ANTENNA	3115	000550005	ETS	2 year	May-17

5-1 Radiated Disturbance Measurements (Below 1GHz) / V



4, Songjuro 236Beon-gil, yanggi-myeon,
Yongin-si, Gyeonggi-do, Korea
Tel : +82-31-3236008,9
Fax : +82-31-3236010
www.ltalab.com

EUT/Model No. : C2N-CBD-P Temp/Humi: 24 / 49

Test Mode : Operating mode Tested by: KANG M G

Data: 1388 File: C:\Program Files (x86)\e3\1707-1.EM6 (1565)

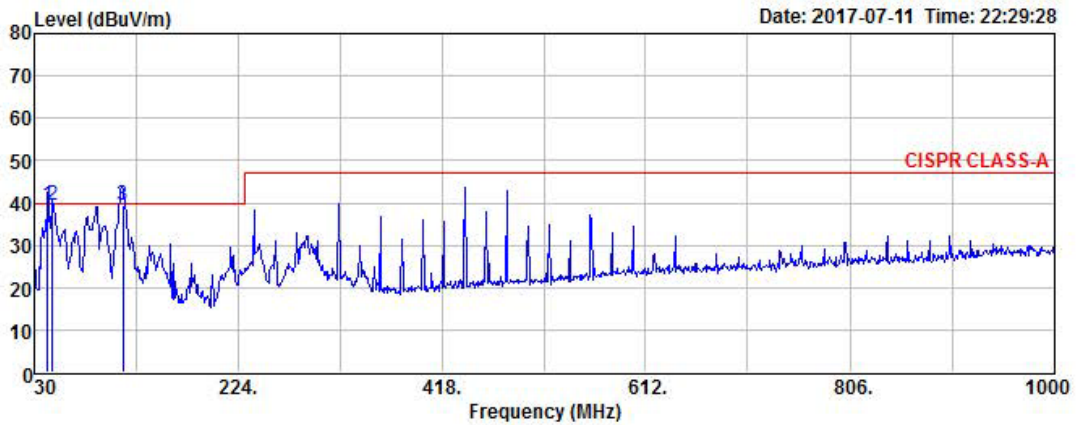

Freq MHz	Reading dBuV	C.F dB	Result QP dBuV/m	Limit dBuV/m	Margin dB	Height cm	Angle deg	Polarity
42.61	53.37	-14.01	39.36	40.00	0.64	155	99	VERTICAL
47.46	53.37	-13.81	39.56	40.00	0.44	125	281	VERTICAL
114.42	53.67	-14.06	39.61	40.00	0.39	119	44	VERTICAL

Remarks: C.F (Correction Factor) = Antenna factor + Cable loss - Preamp gain

**-Continue
(Below 1GHz) / H**



4, Songjuro 236Beon-gil, yanggi-myeon,
Yongin-si, Gyeonggi-do, Korea
Tel : +82-31-3236008,9
Fax : +82-31-3236010
www.ltalab.com

EUT/Model No.: C2N-CBD-P Temp/Humi: 24 / 49

Test Mode : Operating mode Tested by: KANG M G

Data: 1387 File: C:\Program Files (x86)\e3\1707-1.EM6 (1565) Date: 2017-07-11 Time: 22:28:30

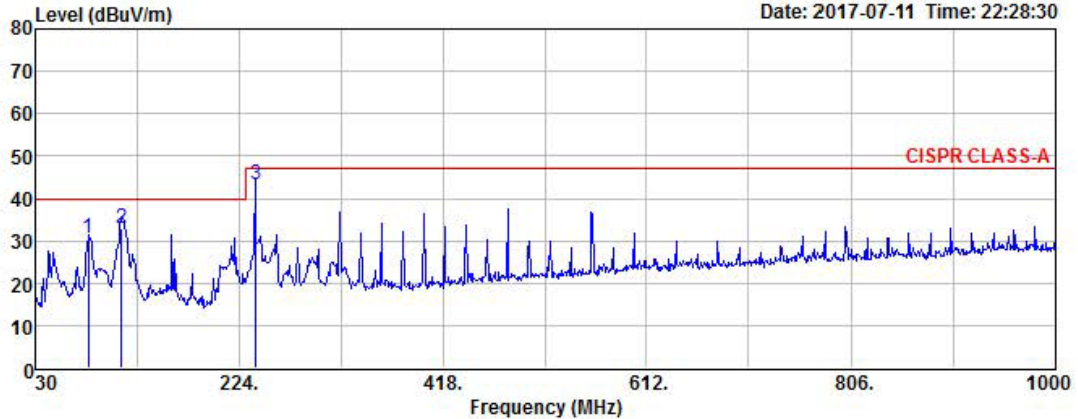

Freq MHz	Reading dBuV	C.F dB	Result QP dBuV/m	Limit dBuV/m	Margin dB	Height cm	Angle deg	Polarity
80.44	48.58	-18.14	30.44	40.00	9.56	332	46	HORIZONTAL
112.45	47.06	-14.27	32.79	40.00	7.21	316	88	HORIZONTAL
240.00	56.16	-12.73	43.43	47.00	3.57	381	101	HORIZONTAL

Remarks: C.F (Correction Factor) = Antenna factor + Cable loss - Preamp gain

5-2 Conducted disturbance Measurements

(LINE) / 50



4, Songjuro 236 Beon-gil, Yangji-myeon
Cheoin-gu, Youngin-si, Gyeonggi-do
449-822 Korea
Tel:+82-31-3236008,9
Fax:+82-31-3236010

EUT / Model No. : C2N-CBD-P Phase : LINE
 Test Mode : Operating mode Test Power : 110 / 50
 Temp. / Humi. : 24 / 55 Test Engineer : KANG M G

Data: 774 File: D:\Conducted Data\2017\LTA_Conduction_2017_07.EM6 (1207)

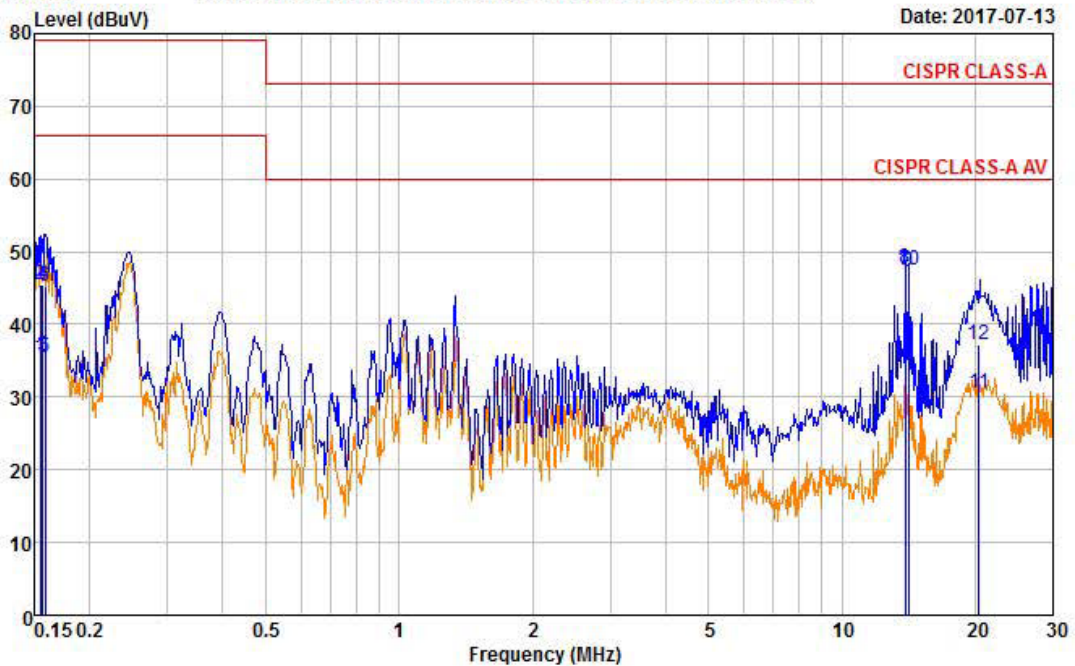

Freq MHz	RD		C.F dB	Result		Limit		Margin	
	QP dBuV	AV dBuV		QP dBuV	AV dBuV	QP dBuV	AV dBuV	QP dB	AV dB
0.155	35.33	25.49	10.03	45.36	35.52	79.00	66.00	33.64	30.48
0.157	35.46	25.55	10.03	45.49	35.58	79.00	66.00	33.51	30.42
0.159	35.16	25.33	10.03	45.19	35.36	79.00	66.00	33.81	30.64
13.885	37.02	36.77	10.68	47.70	47.45	73.00	60.00	25.30	12.55
14.146	36.80	36.63	10.69	47.49	47.32	73.00	60.00	25.51	12.68
20.431	26.07	19.39	11.06	37.13	30.45	73.00	60.00	35.87	29.55

Remarks: C.F (Correction Factor) = Insertion loss + Cable loss + Pulse Limiter

-Continue
(NEUTRAL) / 50



4, Songjuro 236 Beon-gil, Yangji-myeon
Cheoin-gu, Youngin-si, Gyeonggi-do
449-822 Korea
Tel:+82-31-3236008,9
Fax:+82-31-3236010

EUT / Model No. : C2N-CBD-P	Phase : NEUTRAL
Test Mode : Operating mode	Test Power : 110 / 50
Temp. / Humi. : 24 / 55	Test Engineer : KANG M G

Data: 778 File: D:\Conducted Data\2017\LTA_Conduction_2017_07.EM6 (1207) Date: 2017-07-13

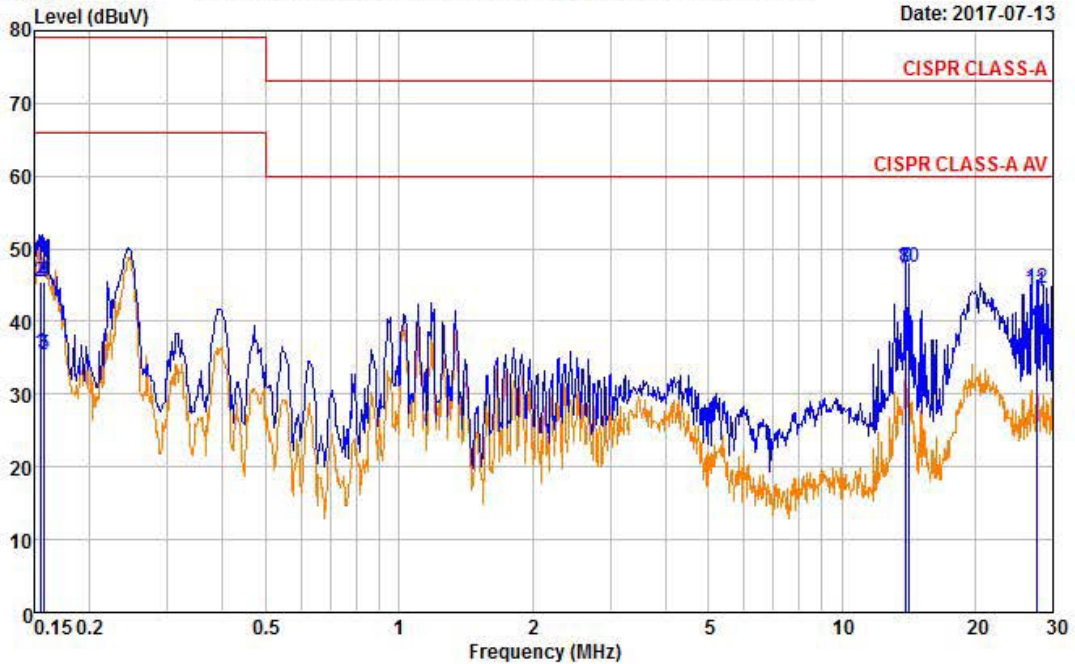

Freq	RD	RD	C.F	Result	Result	Limit	Limit	Margin	Margin
MHz	QP	AV	dB	QP	AV	QP	AV	QP	AV
	dBuV	dBuV		dBuV	dBuV	dBuV	dBuV	dB	dB
0.155	35.38	25.52	10.08	45.46	35.60	79.00	66.00	33.54	30.40
0.157	35.41	25.55	10.08	45.49	35.63	79.00	66.00	33.51	30.37
0.158	35.30	25.43	10.08	45.38	35.51	79.00	66.00	33.62	30.49
13.885	36.84	36.55	10.68	47.52	47.23	73.00	60.00	25.48	12.77
14.147	36.87	36.71	10.70	47.57	47.41	73.00	60.00	25.43	12.59
27.507	33.32	32.93	11.24	44.56	44.17	73.00	60.00	28.44	15.83

Remarks: C.F (Correction Factor) = Insertion loss + Cable loss + Pulse Limiter

5-2 Conducted disturbance Measurements

(LINE) / 60



4, Songjuro 236 Beon-gil, Yangji-myeon
Cheoin-gu, Youngin-si, Gyeonggi-do
449-822 Korea
Tel:+82-31-3236008,9
Fax:+82-31-3236010

EUT / Model No. : C2N-CBD-P Phase : LINE
 Test Mode : Operating mode Test Power : 110 / 60
 Temp. / Humi. : 24 / 55 Test Engineer : KANG M G

Data: 782 File: D:\Conducted Data\2017\LTA_Conduction_2017_07.EM6 (1207)

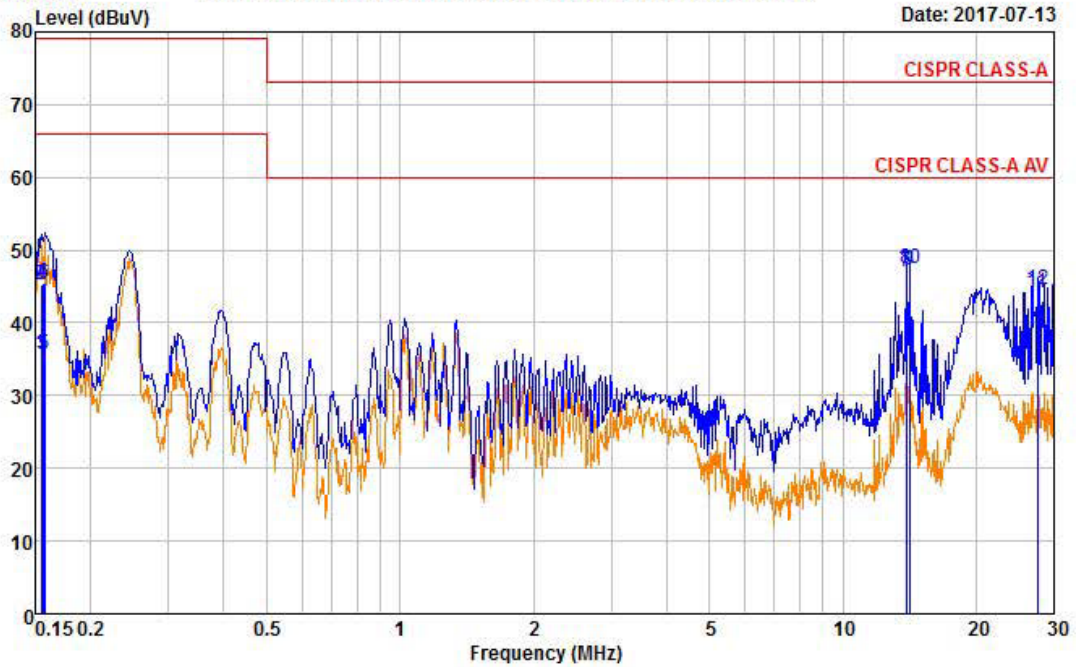

Freq	RD	RD	C.F	Result	Result	Limit	Limit	Margin	Margin
MHz	QP	AV	dB	QP	AV	QP	AV	QP	AV
	dBuV	dBuV		dBuV	dBuV	dBuV	dBuV	dB	dB
0.155	35.29	25.52	10.03	45.32	35.55	79.00	66.00	33.68	30.45
0.156	35.46	25.63	10.03	45.49	35.66	79.00	66.00	33.51	30.34
0.157	35.40	25.59	10.03	45.43	35.62	79.00	66.00	33.57	30.38
13.885	36.74	36.45	10.68	47.42	47.13	73.00	60.00	25.58	12.87
14.147	36.80	36.63	10.69	47.49	47.32	73.00	60.00	25.51	12.68
27.507	33.33	32.95	11.26	44.59	44.21	73.00	60.00	28.41	15.79

Remarks: C.F (Correction Factor) = Insertion loss + Cable loss + Pulse Limiter

-Continue
(NEUTRAL) / 60



4, Songjuro 236 Beon-gil, Yangji-myeon
Cheoin-gu, Youngin-si, Gyeonggi-do
449-822 Korea
Tel:+82-31-3236008,9
Fax:+82-31-3236010

EUT / Model No. : C2N-CBD-P	Phase : NEUTRAL
Test Mode : Operating mode	Test Power : 110 / 60
Temp. / Humi. : 24 / 55	Test Engineer : KANG M G

Data: 786 File: D:\Conducted Data\2017\LTA_Conduction_2017_07.EM6 (1207) Date: 2017-07-13

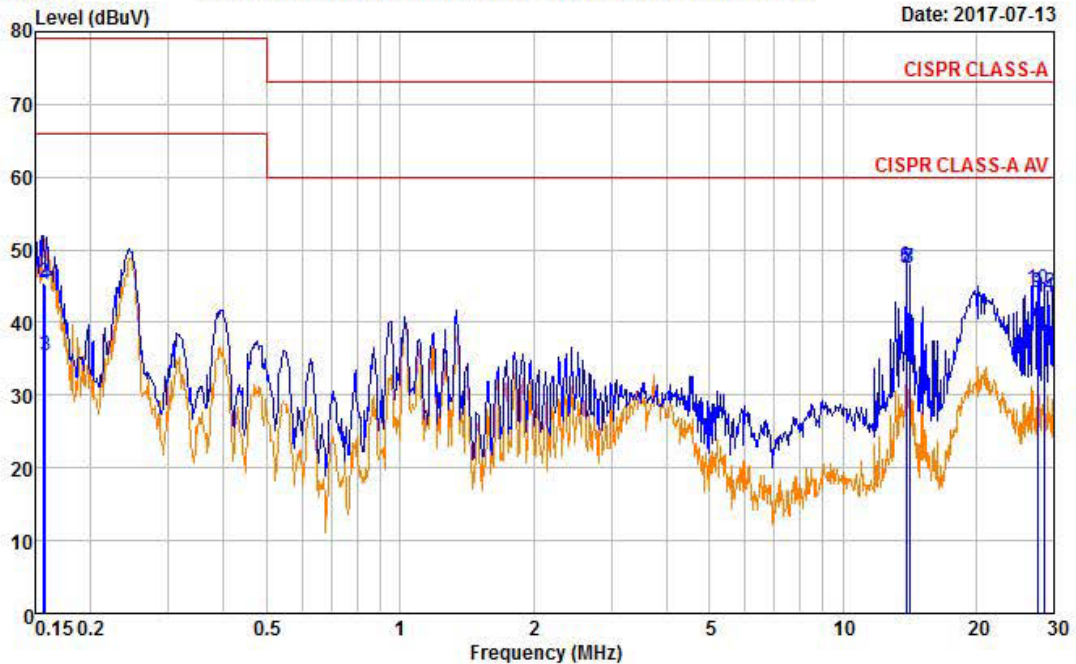

Freq	RD	RD	C.F	Result	Result	Limit	Limit	Margin	Margin
MHz	QP	AV	dB	QP	AV	QP	AV	QP	AV
	dBuV	dBuV		dBuV	dBuV	dBuV	dBuV	dB	dB
0.157	35.43	25.63	10.08	45.51	35.71	79.00	66.00	33.49	30.29
0.158	35.22	25.44	10.08	45.30	35.52	79.00	66.00	33.70	30.48
13.884	36.96	36.71	10.68	47.64	47.39	73.00	60.00	25.36	12.61
14.146	36.87	36.72	10.70	47.57	47.42	73.00	60.00	25.43	12.58
27.507	33.31	32.93	11.24	44.55	44.17	73.00	60.00	28.45	15.83
28.556	32.75	32.18	11.28	44.03	43.46	73.00	60.00	28.97	16.54

Remarks: C.F (Correction Factor) = Insertion loss + Cable loss + Pulse Limiter

Conclusions

Product models " **C2N-CBD-P** " meets all of the CLASS A requirements of the VCCI RULES AND REGULATIONS OF CLASS A (V-3 / 2015.04 Normative ANNEX1:Technical Requirements)

(Limits of radio disturbance characteristics of ITE).

(Refer to Test Specification and Test Results in the "LTA certification", page 4 and 5.)

Photograph of the Radiated Disturbance Measurements (Below 1GHz)

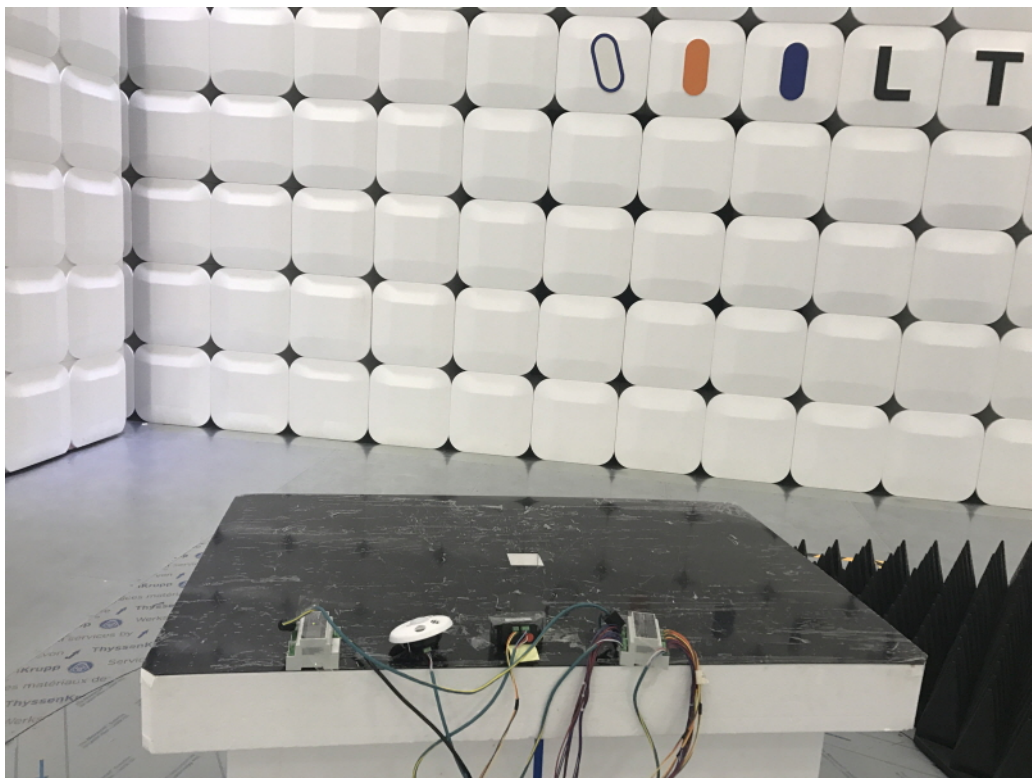
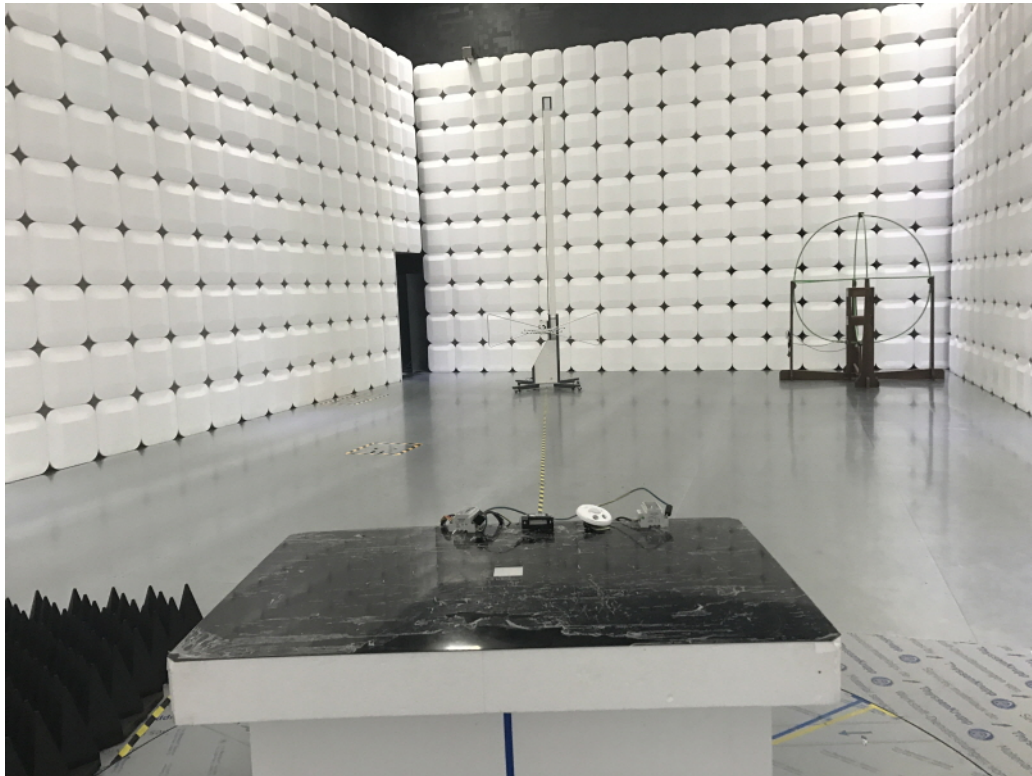

Photograph of the Conducted disturbance Measurements (Maximum emission configuration)



Photograph of the Equipment Under Test

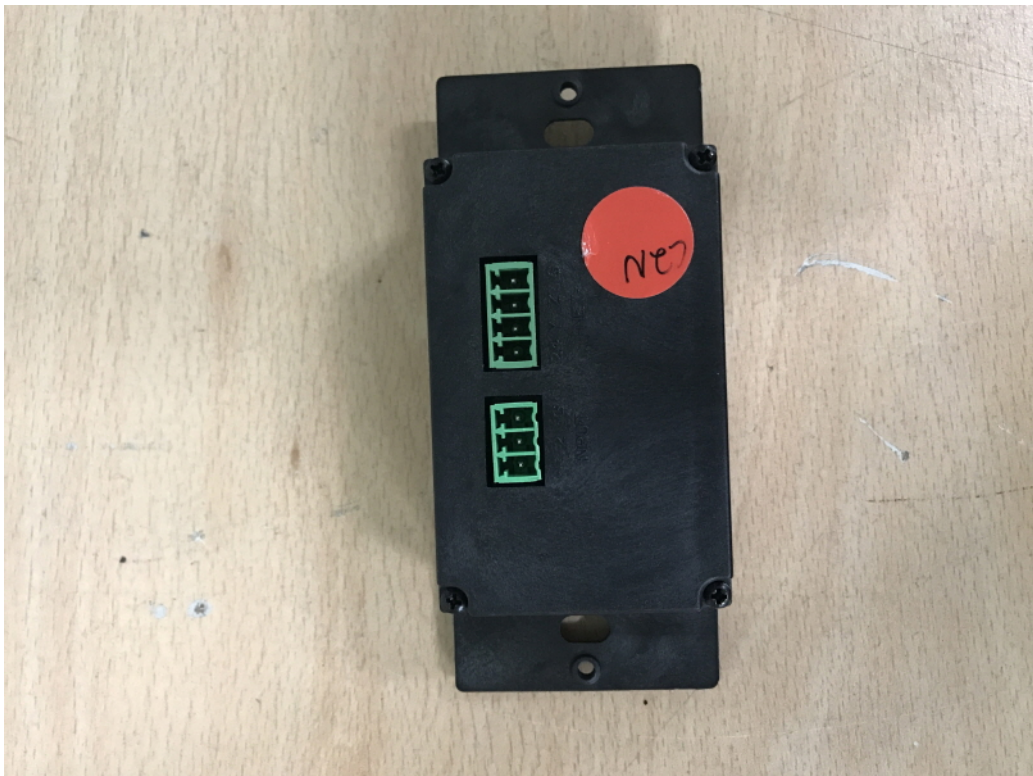

Photograph of the Equipment Under Test



Photograph of the Equipment Under Test



Photograph of the Equipment Under Test

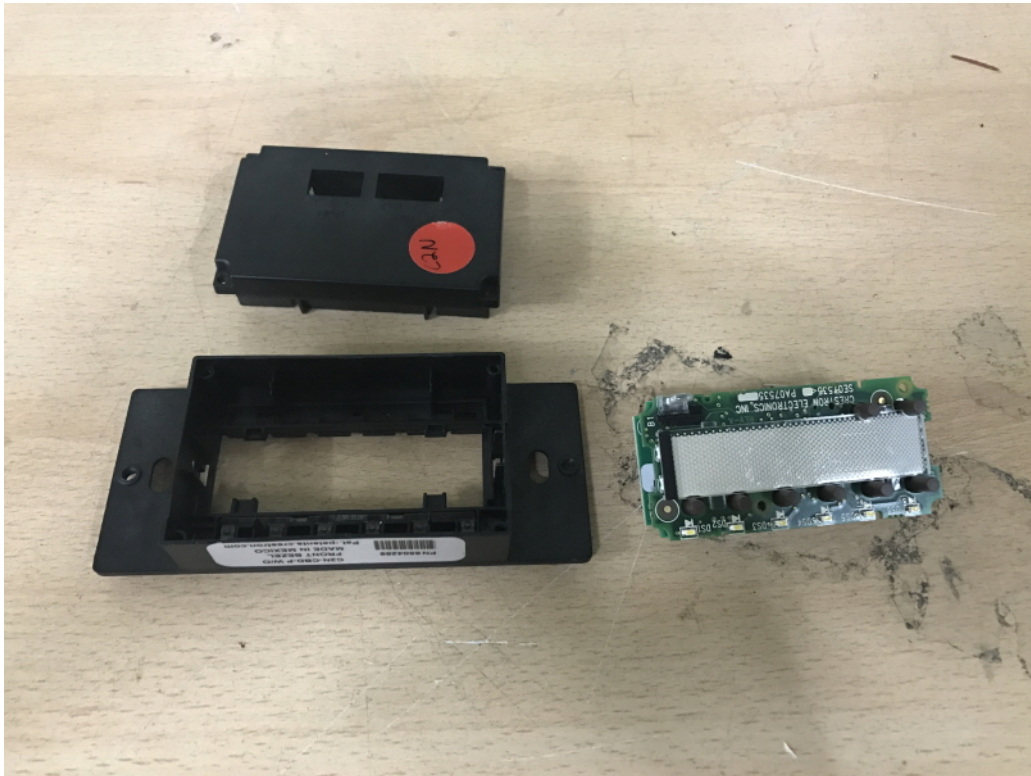

Photograph of the Equipment Under Test

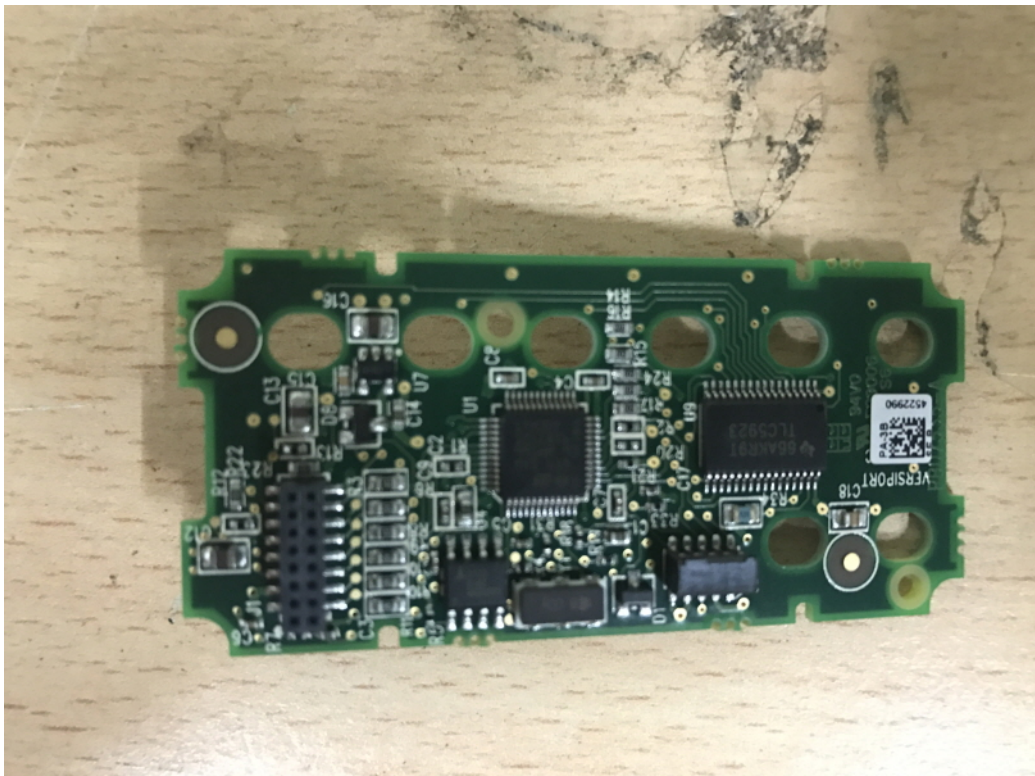
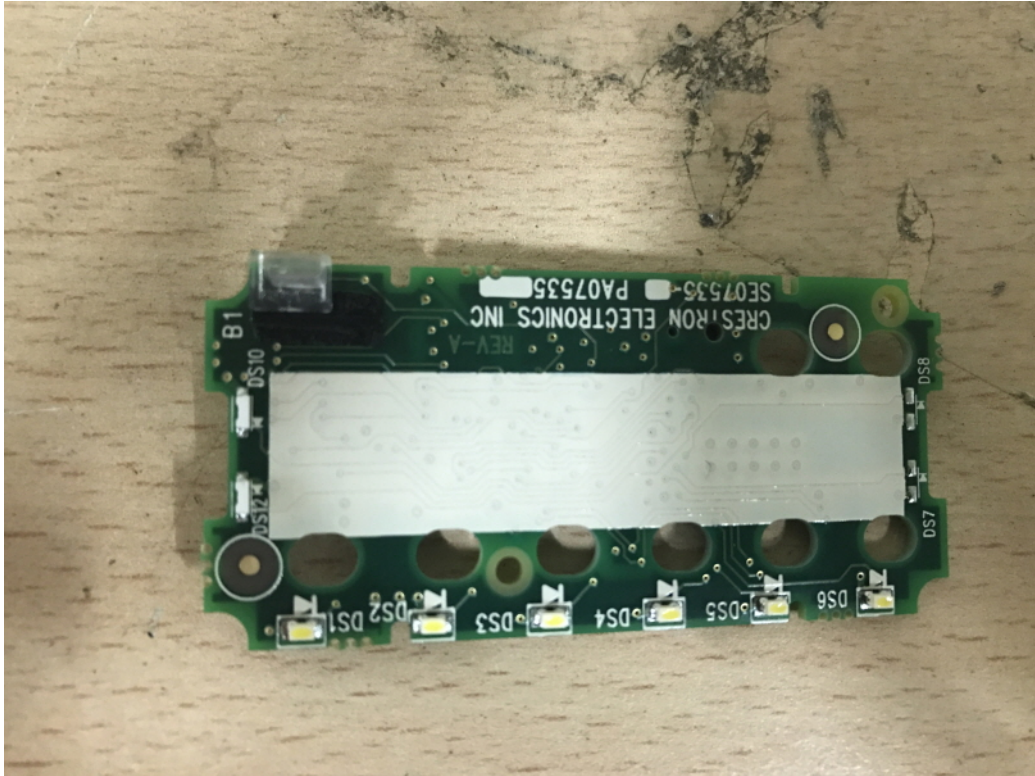

Photograph of the Equipment Under Test

