



# IECC 2018 Zūm<sup>®</sup> Wired Solutions Education Applications

Crestron Electronics, Inc.

**Original Instructions**

The U.S. English version of this document is the original instructions.  
All other languages are a translation of the original instructions.

Crestron product development software is licensed to Crestron dealers and Crestron Service Providers (CSPs) under a limited nonexclusive, nontransferable Software Development Tools License Agreement. Crestron product operating system software is licensed to Crestron dealers, CSPs, and end-users under a separate End-User License Agreement. Both of these Agreements can be found on the Crestron website at [www.crestron.com/legal/software\\_license\\_agreement](http://www.crestron.com/legal/software_license_agreement).

The product warranty can be found at [www.crestron.com/warranty](http://www.crestron.com/warranty).

The specific patents that cover Crestron products are listed at [www.crestron.com/legal/patents](http://www.crestron.com/legal/patents).

Certain Crestron products contain open source software. For specific information, visit [www.crestron.com/opensource](http://www.crestron.com/opensource).

Crestron, the Crestron logo, and Zūm are either trademarks or registered trademarks of Crestron Electronics, Inc. in the United States and/or other countries. DALI is either a trademark or registered trademark of IEEE Industry Standards and Technology Organization, Inc. in the United States and/or other countries. Other trademarks, registered trademarks, and trade names may be used in this document to refer to either the entities claiming the marks and names or their products. Crestron disclaims any proprietary interest in the marks and names of others. Crestron is not responsible for errors in typography or photography.





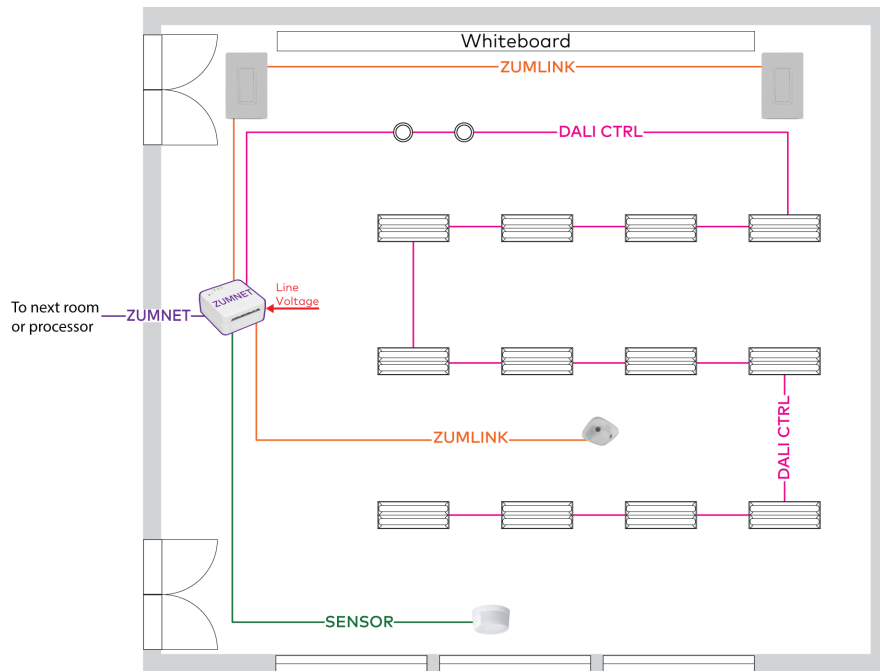

©2021 Crestron Electronics, Inc.



# Zūm® Wired: DALI® Drivers



## Bill of Materials

Item	Product	Qty
	ZUMNET-JBOX-DALI Zūm Net, DALI	1
	ZUMLINK-KP Zūm Link Keypad, Manual Control	2
	ZUMLINK-DT-QUATTRO-DLS Zūm Link Presence Detector/ Closed-Loop Daylight Sensor	1
	GLA-LDL-PC-0-10 Open/Closed Loop Daylight Sensor	1
	CBL-CAT5E-ZUMLINK-P Zūm Link CAT5e, various lengths	TBD
	CBL-CAT5E-ZUMNET-P Zūm Net CAT5e, various lengths	TBD





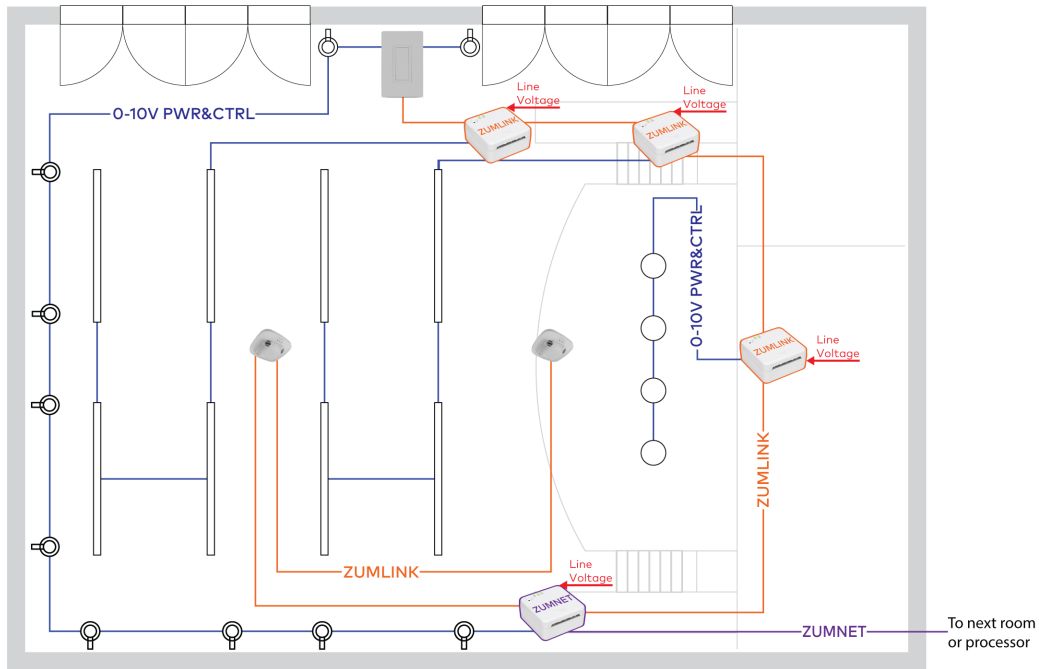

## Code

<b>Manual Control Device</b> C405.2.5, C405.2.2.2 Physical control interface for occupant
<b>Vacancy Sensor Manual On</b> C405.2.1.1 Physical control interface for occupant, Auto Off during vacancy
<b>Occupancy Sensor Full Off</b> C405.2.1 Auto Off during vacancy
<b>Daylight Response</b> C405.2, C405.2.61 Exception C405.2.3.1 Adjust lights based on available daylight

# Zūm® Wired: 0 - 10V Drivers



## Bill of Materials

Item	Product	Qty
	ZUMNET-JBOX-16A-LV Zūm Net, Dimmer, 0-10V, 16A	1
	ZUMLINK-JBOX-16A-LV Zūm Link, Dimmer, 0-10V 16A	3
	ZUMLINK-KP Zūm Link Keypad, Manual Control	1
	ZUMLINK-DT-QUATTRO-DLS Zūm Link Presence Detector/ Closed-Loop Daylight Sensor	2
	CBL-CAT5E-ZUMLINK-P Zūm Link CAT5e, various lengths	TBD
	CBL-CAT5E-ZUMNET-P Zūm Net CAT5e, various lengths	TBD



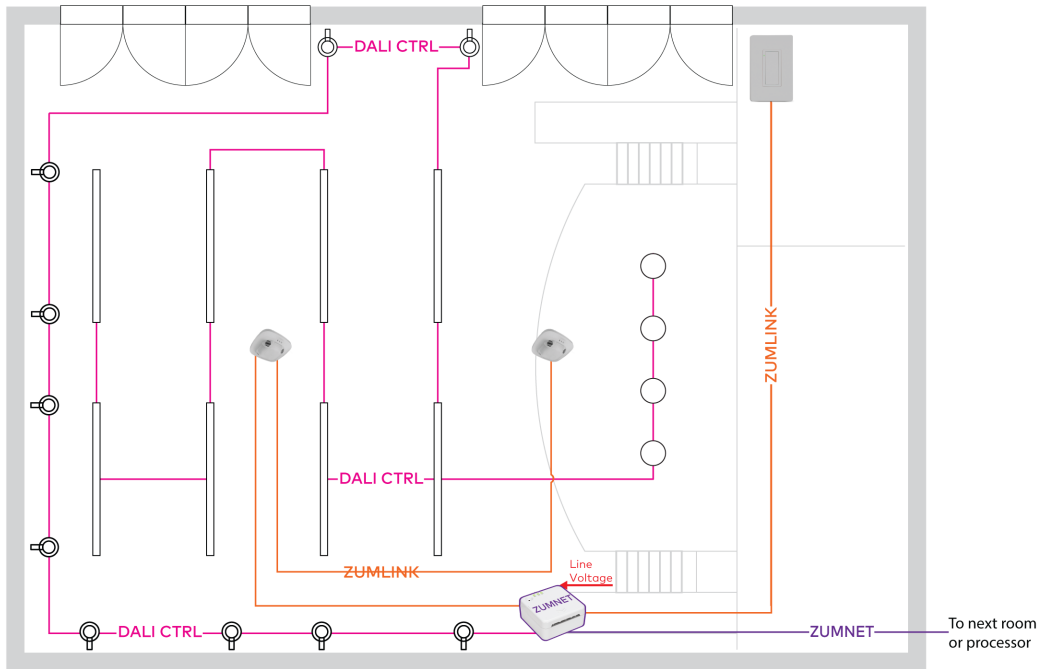

## Code

- Manual Control Device**  
C405.2.5, C405.2.2.2  
Physical control interface for occupant
- Occupancy Sensor Partial On**  
C405.2.1.1  
Partial On during occupancy
- Occupancy Sensor Full Off**  
C405.2.1  
Auto Off during vacancy
- Occupancy Sensor Partial Off**  
C405.2.1  
Partial Off during vacancy
- Daylight Response**  
C405.2, C405.2.61  
Exception C405.2.3.1  
Adjust lights based on available daylight

# Zūm® Wired: DALI® Drivers



## Bill of Materials

Item	Product	Qty
	ZUMNET-JBOX-DALI Zūm Net, DALI	1
	ZUMLINK-KP Zūm Link Keypad, Manual Control	1
	ZUMLINK-DT-QUATTRO-DLS Zūm Link Presence Detector/ Closed-Loop Daylight Sensor	2
	CBL-CAT5E-ZUMLINK-P Zūm Link CAT5e, various lengths	TBD
	CBL-CAT5E-ZUMNET-P Zūm Net CAT5e, various lengths	TBD

## Code

- Manual Control Device**  
C405.2.5, C405.2.2.2  
Physical control interface for occupant

---

- Occupancy Sensor Partial On**  
C405.2.1.1  
Partial On during occupancy

---

- Occupancy Sensor Full Off**  
C405.2.1  
Auto Off during vacancy

---

- Occupancy Sensor Partial Off**  
C405.2.1  
Partial Off during vacancy



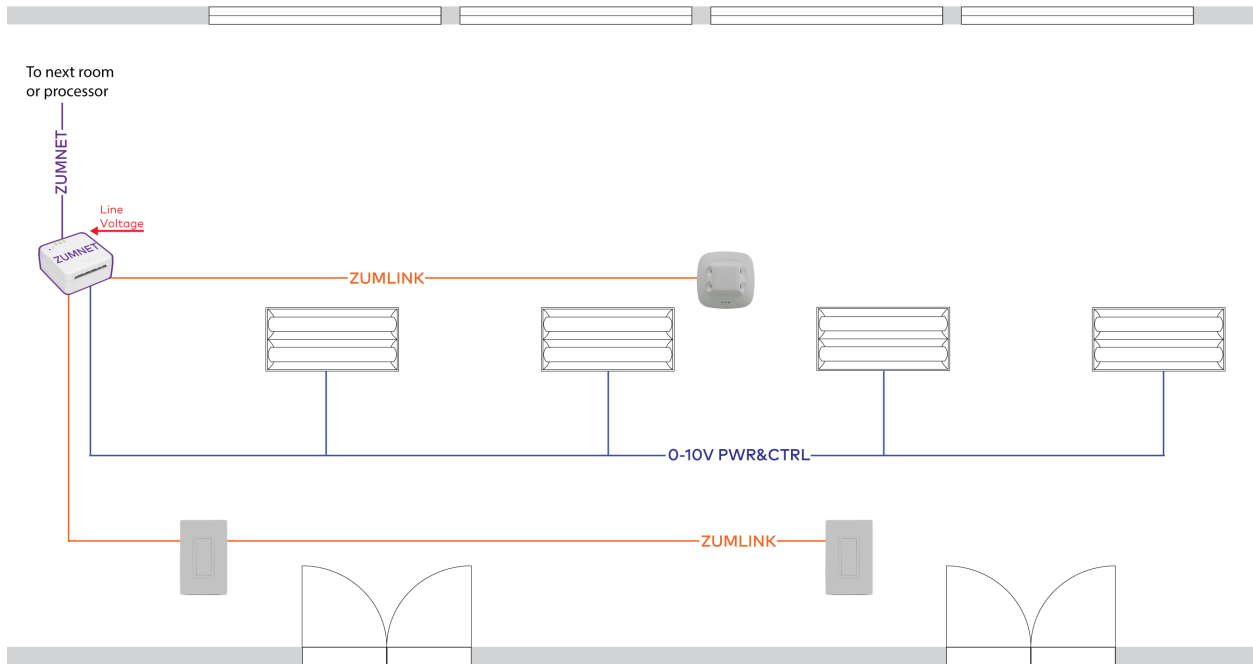

---

- Daylight Response**  
C405.2, C405.2.61  
Exception C405.2.3.1  
Adjust lights based on available daylight

## Züm® Wired: 0 - 10V Drivers



## Bill of Materials

Item	Product	Qty
	ZUMNET-JBOX-16A-LV Züm Net, Dimmer, 0-10V, 16A	1
	ZUMLINK-KP Züm Link Keypad, Manual Control	2
	ZUMLINK-US-HALLWAY-DLS Züm Link Presence Detector Closed-Loop Daylight Sensor	1
	CBL-CAT5E-ZUMLINK-P Züm Link CAT5e, various lengths	TBD
	CBL-CAT5E-ZUMNET-P Züm Net CAT5e, various lengths	TBD

## Code

<b>Manual Control Device</b> C405.2.5, C405.2.2.2 Physical control interface for occupant
<b>Occupancy Sensor Full On</b> C405.2.1, C405.2.1.1 Full ON during occupancy
<b>Occupancy Sensor Partial Off</b> C405.2.1 Partial Off during vacancy
<b>Daylight Response</b> C405.2, C405.2.61 Exception C405.2.3.1 Adjust lights based on available daylight

# Züm® Wired: 0 - 10V Drivers

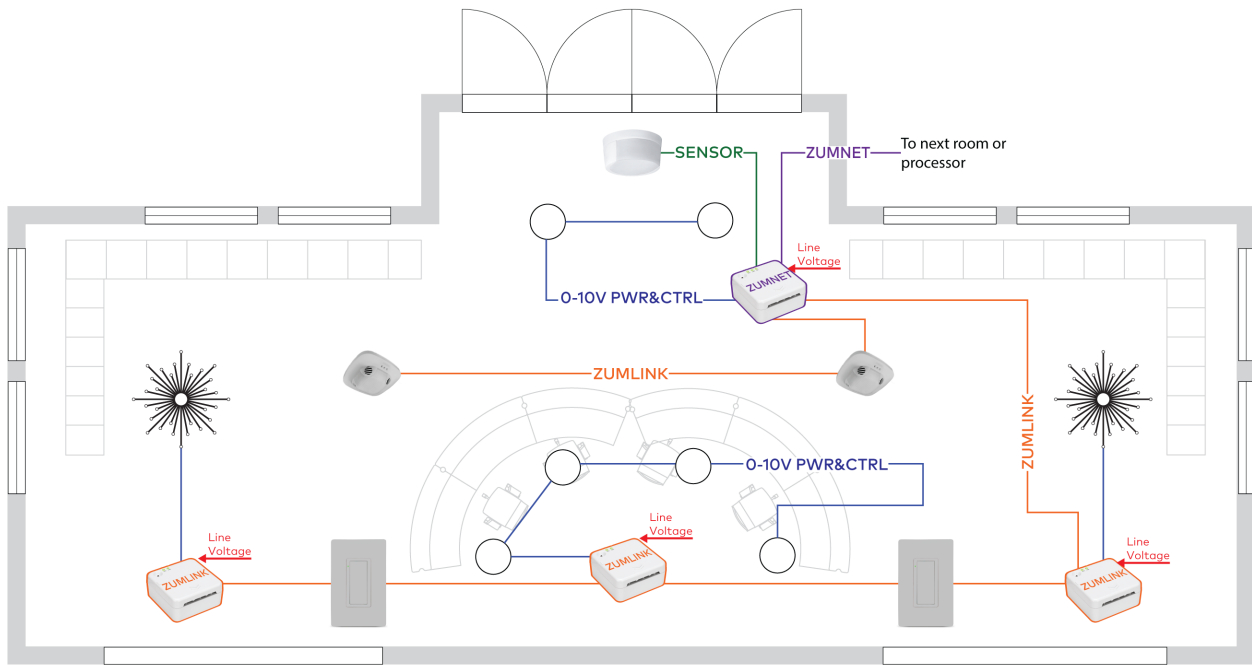

## Bill of Materials

Item	Product	Qty
	ZUMNET-JBOX-16A-LV Züm Net, Dimmer, 0-10V, 16A	1
	ZUMLINK-JBOX-16A-LV Züm Link, Dimmer, 0-10V 16A	3
	ZUMLINK-KP Züm Link Keypad, Manual Control	2
	ZUMLINK-DT-QUATTRO-DLS Züm Link Presence Detector/ Closed-Loop Daylight Sensor	2
	GLA-LDL-PC-0-10 Open/Closed Loop Daylight Sensor	1
	CBL-CAT5E-ZUMLINK-P Züm Link CAT5e, various lengths	TBD
	CBL-CAT5E-ZUMNET-P Züm Net CAT5e, various lengths	TBD

## Code





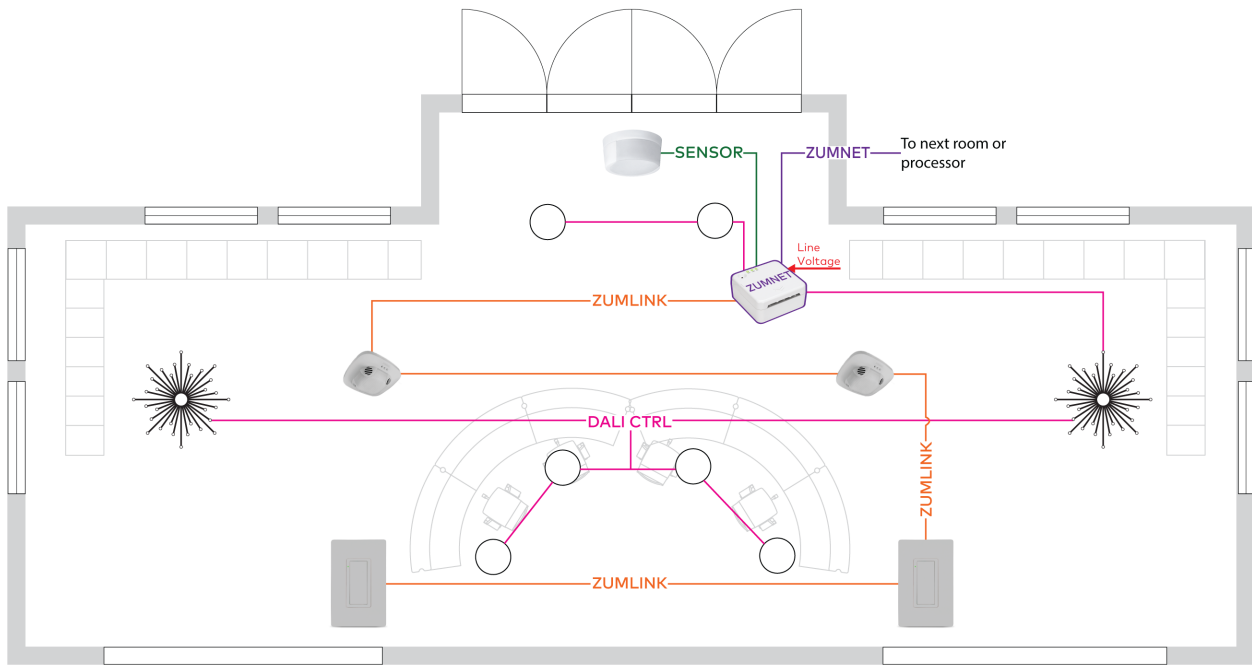

- Manual Control Device**  
C405.2.5, C405.2.2.2  
Physical control interface for occupant
- Programmable Timeclock**  
C405.2.2.1, C405.2.6.2,  
C405.2.6.3, C405.2.6.4  
Programmable partial On
- Occupancy Sensor Full On**  
C405.2.1, C405.2.1.1  
Full ON during occupancy
- Occupancy Sensor Full Off**  
C405.2.1  
Auto Off during vacancy
- Daylight Response**  
C405.2, C405.2.61  
Exception C405.2.3.1  
Adjust lights based on available daylight



# Zūm® Wired: DALI® Drivers



## Bill of Materials

Item	Product	Qty
	ZUMNET-JBOX-DALI Zūm Net, DALI	1
	ZUMLINK-KP Zūm Link Keypad, Manual Control	2
	ZUMLINK-DT-QUATTRO-DLS Zūm Link Presence Detector/ Closed-Loop Daylight Sensor	2
	GLA-LDL-PC-0-10 Open/Closed Loop Daylight Sensor	1
	CBL-CAT5E-ZUMLINK-P Zūm Link CAT5e, various lengths	TBD
	CBL-CAT5E-ZUMNET-P Zūm Net CAT5e, various lengths	TBD

## Code

- Manual Control Device**  
C405.2.5, C405.2.2.2  
Physical control interface for occupant

---

- Programmable Timeclock**  
C405.2.2.1, C405.2.6.2,  
C405.2.6.3, C405.2.6.4  
Programmable partial On

---

- Occupancy Sensor Full On**  
C405.2.1, C405.2.1.1  
Full ON during occupancy

---

- Occupancy Sensor Full Off**  
C405.2.1  
Auto Off during vacancy



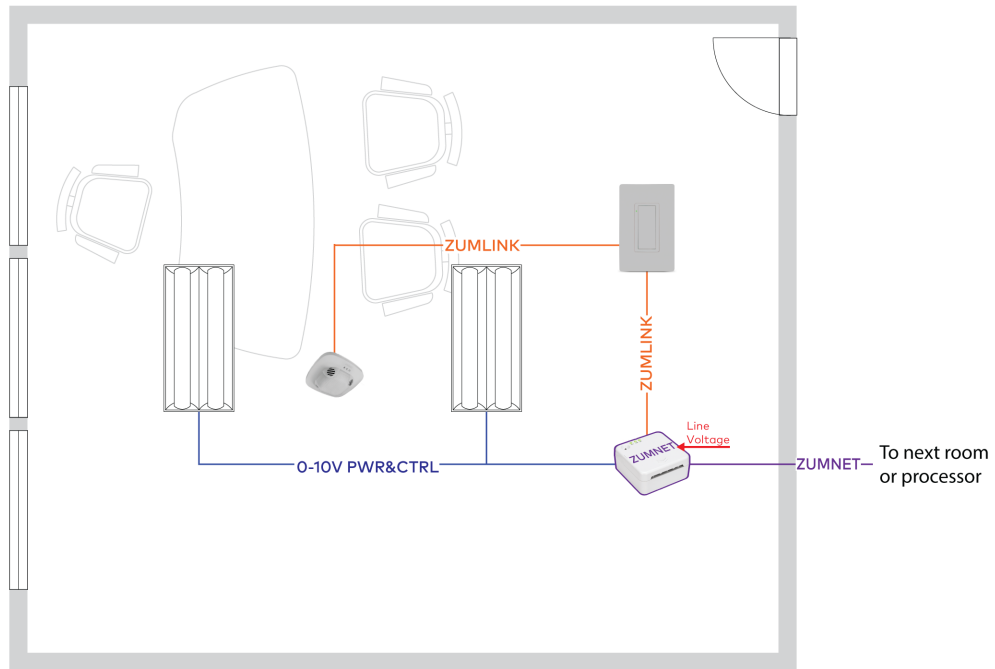

---

- Daylight Response**  
C405.2, C405.2.61  
Exception C405.2.3.1  
Adjust lights based on available daylight

# Zūm® Wired: 0 - 10V Drivers



## Bill of Materials

Item	Product	Qty
	ZUMNET-JBOX-16A-LV Zūm Net, Dimmer, 0-10V, 16A	1
	ZUMLINK-KP Zūm Link Keypad, Manual Control	1
	ZUMLINK-DT-QUATTRO-DLS Zūm Link Presence Detector/ Closed-Loop Daylight Sensor	1
	CBL-CAT5E-ZUMLINK-P Zūm Link CAT5e, various lengths	TBD
	CBL-CAT5E-ZUMNET-P Zūm Net CAT5e, various lengths	TBD

## Code

- Manual Control Device**  
C405.2.5, C405.2.2.2  
Physical control interface for occupant

---

- Vacancy Sensor Manual On**  
C405.2.1.1  
Physical control interface for occupant, Auto Off during vacancy

---

- Occupancy Sensor Full Off**  
C405.2.1  
Auto Off during vacancy



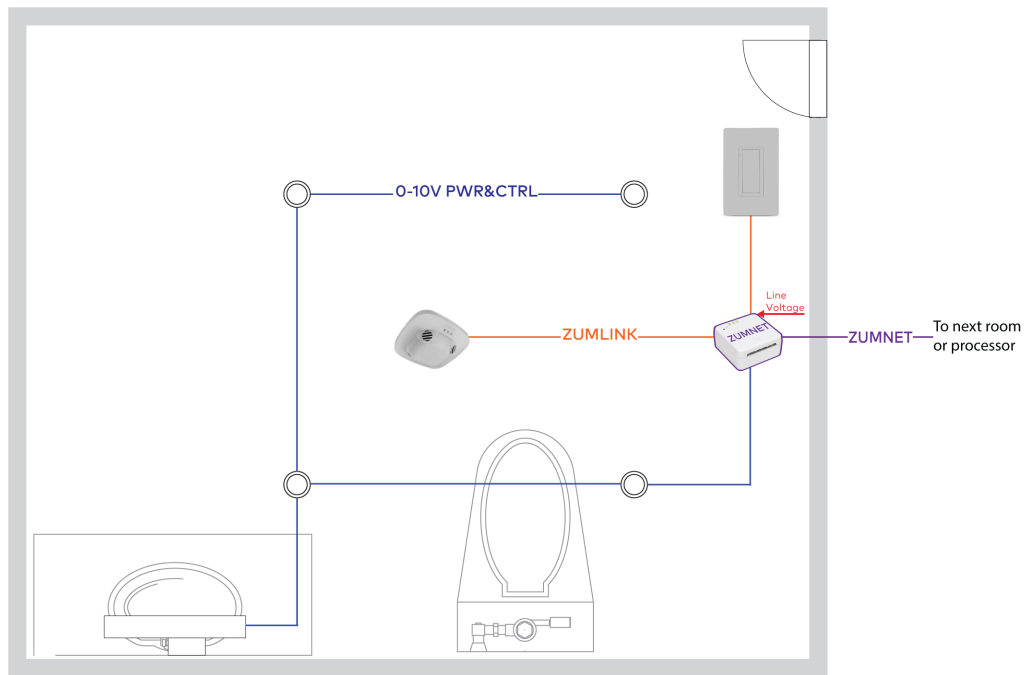

---

- Daylight Response**  
C405.2, C405.2.61  
Exception C405.2.3.1  
Adjust lights based on available daylight

# Zūm® Wired: 0 - 10V Drivers



## Bill of Materials

Item	Product	Qty
	ZUMNET-JBOX-16A-LV Zūm Net, Dimmer, 0-10V, 16A	1
	ZUMLINK-KP Zūm Link Keypad, Manual Control	1
	ZUMLINK-DT-QUATTRO-DLS Zūm Link Presence Detector/ Closed-Loop Daylight Sensor	1
	CBL-CAT5E-ZUMLINK-P Zūm Link CAT5e, various lengths	TBD
	CBL-CAT5E-ZUMNET-P Zūm Net CAT5e, various lengths	TBD





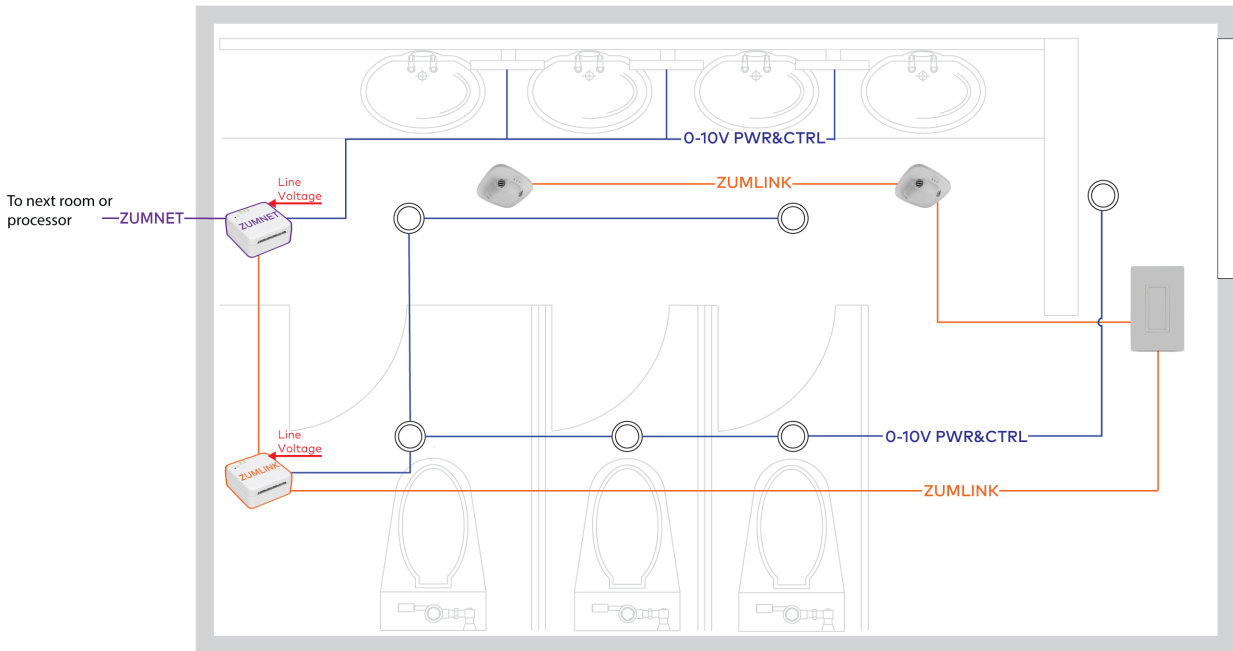

## Code

- Manual Control Device**  
C405.2.5, C405.2.2.2  
Physical control interface for occupant
- Occupancy Sensor Full On**  
C405.2.1, C405.2.1.1  
Full ON during occupancy
- Occupancy Sensor Full Off**  
C405.2.1  
Auto Off during vacancy
- Daylight Response**  
C405.2, C405.2.61  
Exception C405.2.3.1  
Adjust lights based on available daylight

# Zūm® Wired: 0 - 10V Drivers



## Bill of Materials

Item	Product	Qty
	ZUMNET-JBOX-16A-LV Zūm Net, Dimmer, 0-10V, 16A	1
	ZUMLINK-JBOX-16A-LV Zūm Link, Dimmer, 0-10V 16A	1
	ZUMLINK-KP Zūm Link Keypad, Manual Control	1
	ZUMLINK-DT-QUATTRO-DLS Zūm Link Presence Detector/ Closed-Loop Daylight Sensor	2
	CBL-CAT5E-ZUMLINK-P Zūm Link CAT5e, various lengths	TBD
	CBL-CAT5E-ZUMNET-P Zūm Net CAT5e, various lengths	TBD



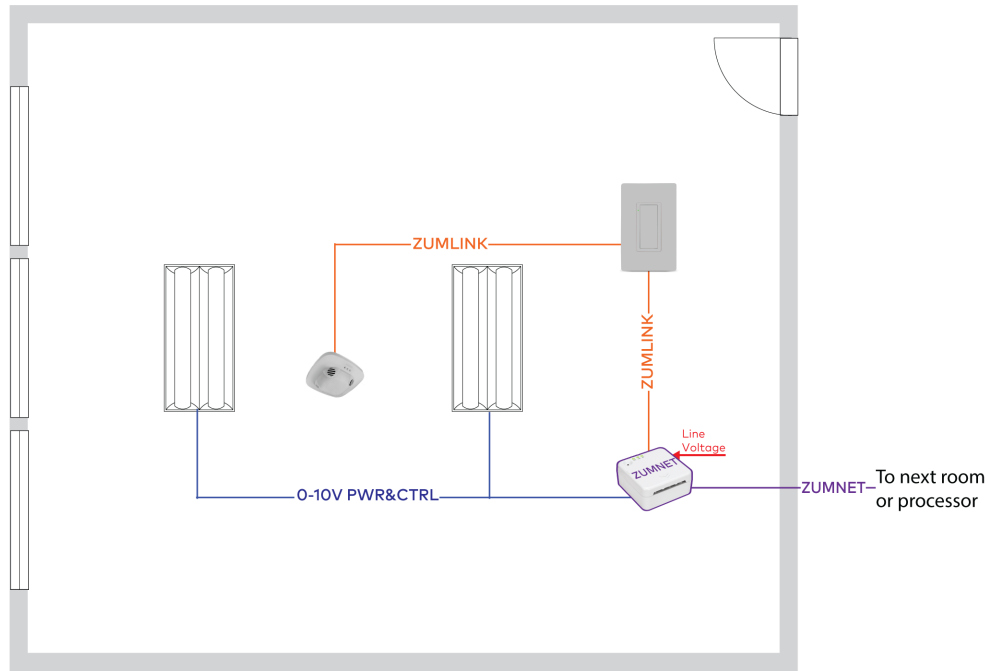

## Code

- Manual Control Device**  
C405.2.5, C405.2.2.2  
Physical control interface for occupant
- Occupancy Sensor Full On**  
C405.2.1, C405.2.1.1  
Full ON during occupancy
- Occupancy Sensor Full Off**  
C405.2.1  
Auto Off during vacancy
- Daylight Response**  
C405.2, C405.2.61  
Exception C405.2.3.1  
Adjust lights based on available daylight

# Zūm® Wired: 0 - 10V Drivers



## Bill of Materials

Item	Product	Qty
	ZUMNET-JBOX-16A-LV Zūm Net, Dimmer, 0-10V, 16A	1
	ZUMLINK-KP Zūm Link Keypad, Manual Control	1
	ZUMLINK-DT-QUATTRO-DLS Zūm Link Presence Detector/ Closed-Loop Daylight Sensor	1
	CBL-CAT5E-ZUMLINK-P Zūm Link CAT5e, various lengths	TBD
	CBL-CAT5E-ZUMNET-P Zūm Net CAT5e, various lengths	TBD

## Code

- Manual Control Device**  
C405.2.5, C405.2.2.2  
Physical control interface for occupant

---

- Vacancy Sensor Manual On**  
C405.2.1.1  
Physical control interface for occupant, Auto Off during vacancy

---

- Occupancy Sensor Full Off**  
C405.2.1  
Auto Off during vacancy

---

- Daylight Response**  
C405.2, C405.2.61  
Exception C405.2.3.1  
Adjust lights based on available daylight

---

**Contact Info**

---

Name

Company

Address 1

Address 2

City, State, Zip

Phone

Email

Website

---

---

**Project Notes**

---

**Square Footage**

**Cost/Sq. Ft.**

--	--