



View this document in HTML  
[crestron.com/docs/9487](https://crestron.com/docs/9487)



Product Manual

IV-SAM-VX and IV-SAM-VX2 Series

Crestron 1 Beyond Automate VX  
Series Software

The original language version of this document is U.S. English.  
All other languages are a translation of the original document.

Crestron product development software is licensed to Crestron dealers and Crestron Service Providers (CSPs) under a limited nonexclusive, nontransferable Software Development Tools License Agreement. Crestron product operating system software is licensed to Crestron dealers, CSPs, and end-users under a separate End-User License Agreement. Both of these Agreements can be found on the Crestron website at [www.crestron.com/legal/software\\_license\\_agreement](http://www.crestron.com/legal/software_license_agreement).

The product warranty can be found at [www.crestron.com/warranty](http://www.crestron.com/warranty).

The specific patents that cover Crestron products are listed online at [www.crestron.com/legal/patents](http://www.crestron.com/legal/patents).

Certain Crestron products contain open source software. For specific information, please visit [www.crestron.com/opensource](http://www.crestron.com/opensource).

Crestron and the Crestron logo are either trademarks or registered trademarks of Crestron Electronics, Inc. in the United States and/or other countries. Dante is either a trademark or a registered trademark of Audinate Pty Ltd. in the United States and/or other countries. Audio Technica is either a trademark or a registered trademark of Audio-Technica U.S, Inc in the United States and/or other countries. Biamp and Tesira are either trademarks or registered trademarks of Biamp Systems, LLC in the United States and/or other countries. Blackmagic is either a trademark or a registered trademark of Blackmagic Design Pty. Ltd in the United States and/or other countries. Chrome is either a trademark or a registered trademark of Google, Inc. in the United States and/or other countries. HDMI and the HDMI logo are either trademarks or registered trademarks of HDMI Licensing, LLC in the United States and/or other countries. Microsoft Teams is either a trademark or registered trademark of Microsoft Corporation in the United States and/or other countries. NDI is either a trademark or a registered trademark of NewTek, Inc. in the United States and/or other countries. Q-SYS is either a trademark or a registered trademark of QSC, LLC in the United States and/or other countries. Sennheiser is either a trademark or a registered trademark of Sennheiser Electronic GmbH & Co. KG in the United States and/or other countries. Intellimix and Shure are either trademarks or registered trademarks of Shure Incorporated in the United States and/or other countries. TAIDEN is either a trademark or registered trademark of Shenzhen TAIDEN Industrial Co., LTD in the United States and other countries. Wirecast is either a trademark or a registered trademark of Telestream, LLC in the United States and/or other countries. Yamaha is either a trademark or a registered trademark of Yamaha Corporation of American and Yamaha Corporation in the United States and other countries. Other trademarks, registered trademarks, and trade names may be used in this document to refer to either the entities claiming the marks and names or their products. Crestron disclaims any proprietary interest in the marks and names of others. Crestron is not responsible for errors in typography or photography.

©2024 Crestron Electronics, Inc.

# Contents

- IV-SAM-VX and IV-SAM-VX2 Series ..... 1**
- Features ..... 2**
  - Room Designer Features ..... 3
  - IV-PROSERVICE-1B Features ..... 5
- System Design ..... 7**
  - System Components ..... 8
    - Cameras ..... 9
    - Intelligent Array Microphones ..... 11
    - Wired and Wireless Microphones ..... 12
    - Discussion Systems ..... 13
  - Component Implementation ..... 14
    - Camera Implementation ..... 15
    - Microphone Implementation ..... 16
  - Room Design ..... 17
    - Extra Large Rooms ..... 17
    - Multipurpose Spaces ..... 17
    - High Value Rooms ..... 17
    - Divisible Spaces ..... 18
    - Training and Learning Spaces ..... 18
  - Room Design Examples ..... 19
    - Room Designer Key ..... 19
    - Large Boardroom with Standard Monitors ..... 21
    - High Value Boardroom with Table Mics ..... 24
    - Divisible Room ..... 27
- Room Designer ..... 32**
  - Access the Web Configuration Interface ..... 33
  - Floor Plan Upload ..... 36
  - Upload a Project ..... 37
  - Room Designer Settings ..... 39
    - Undo Command ..... 39
    - Delete Current Configuration ..... 39
    - General Settings ..... 40
    - View Settings ..... 47
    - Adjudicator Settings ..... 57
    - Notes Page ..... 58
  - Camera Device Configuration ..... 59
    - Remove Camera ..... 60
    - Model ..... 61
    - Network ..... 63

Position .....	64
Orientation .....	65
Microphone Device Configuration .....	67
Remove Mic Device .....	69
Model .....	70
Network .....	72
Position .....	73
Orientation .....	74
Mics .....	75
Adjudicator .....	75
Noise Threshold .....	76
Duplicate Device .....	77
Virtual Mic and Blocking Zone Configuration .....	78
Add Virtual Mic .....	80
Remove Virtual Mic .....	81
Add Blocking Zone .....	81
Remove Blocking Zone .....	81
Virtual Mic Settings .....	82
Configuring Adjudicators .....	90
AutoSwitch Preview .....	93
<b>Configuration .....</b>	<b>99</b>
System Configuration .....	100
Access the Web Configuration Interface .....	100
General Settings .....	103
Titling Settings .....	108
Advanced Settings .....	110
Visual AI .....	114
Admin and User Settings .....	120
Scenario Setup Tool .....	124
Scenario Selection .....	125
Room Configuration Selection .....	125
AutoSwitch Action .....	126
AutoTracking Action .....	126
Output Action .....	128
Layout Selection .....	128
Shot Selection .....	128
Camera Aiming .....	129
Save And Remove Scenario .....	131
Wirecast Configuration .....	132
Configure Basic Shots .....	132
Create Side-by-Side Shots .....	132
Create Layouts .....	133
Configure Audio .....	134
DSP Configuration .....	135
Shure Intellimix® Room and P300 Configuration for Automate VX .....	136



Biamp Tesira™ Configuration for Automate VX .....	143
QSC Q-SYS™ Core Configuration for Automate VX .....	163
<b>Operation .....</b>	<b>181</b>
Main Menu .....	181
Layouts Menu .....	183
Room Configs Menu .....	184
Cameras Menu .....	185
Scenarios Menu .....	186
<b>Resources .....</b>	<b>187</b>
Crestron Support and Training .....	187
Product Certificates .....	187
Related Documentation .....	187

# IV-SAM-VX and IV-SAM-VX2 Series

## Crestron 1 Beyond Automate VX Series Software

The Crestron 1 Beyond Automate VX Series camera switching systems bring a full multicamera studio experience to meetings, town halls, and classrooms. [Crestron 1 Beyond cameras](#) automatically switch based on the location of the active speaking participant. Visual AI enhanced camera switching intelligently frames camera shots with the participants centered.

### NOTES:

- 1 Beyond Automate VX models are functionally similar. For simplicity within this documentation, the term "Automate VX" is used except where otherwise noted.
- This document is current as of the Automate VX version 6.2 release.
- The following camera models must be running the listed minimum firmware to connect to Automate VX version 6.2:
  - **IV-CAMPTZ-12 Series:** 3.1.23
  - **IV-CAMPTZ-20 Series:** 3.1.41
  - **IV-CAMA3-20 Series:** 5.1.105

This product manual is intended for Room Designer software and Automate VX system configuration menus.

- For more information about Automate VX2 installation and initial setup procedures, refer to the [Automate VX2 Series Product Manual](#).
- For more information about Automate VX installation and initial setup procedures, refer to the [Automate VX Series Product Manual](#).

# Features

Refer to the following sections for more information on the 1 Beyond Automate VX model features.

- [Room Designer Features on page 3](#)
- [IV-PROSERVICE-1B Features on page 5](#)

# Room Designer Features

[Crestron Intelligent Video Room Designer Software](#) provides the tools needed to design, configure, and verify Intelligent Video meeting spaces. A simple browser interface can be used to help choose the best position for cameras and microphones in the room. Designed meeting spaces can be saved and imported into an Automate VX multi-camera switching solution for fast deployment. To learn more about the Crestron Intelligent Video Room Designer Software, visit the [Crestron Technical Institute](#).

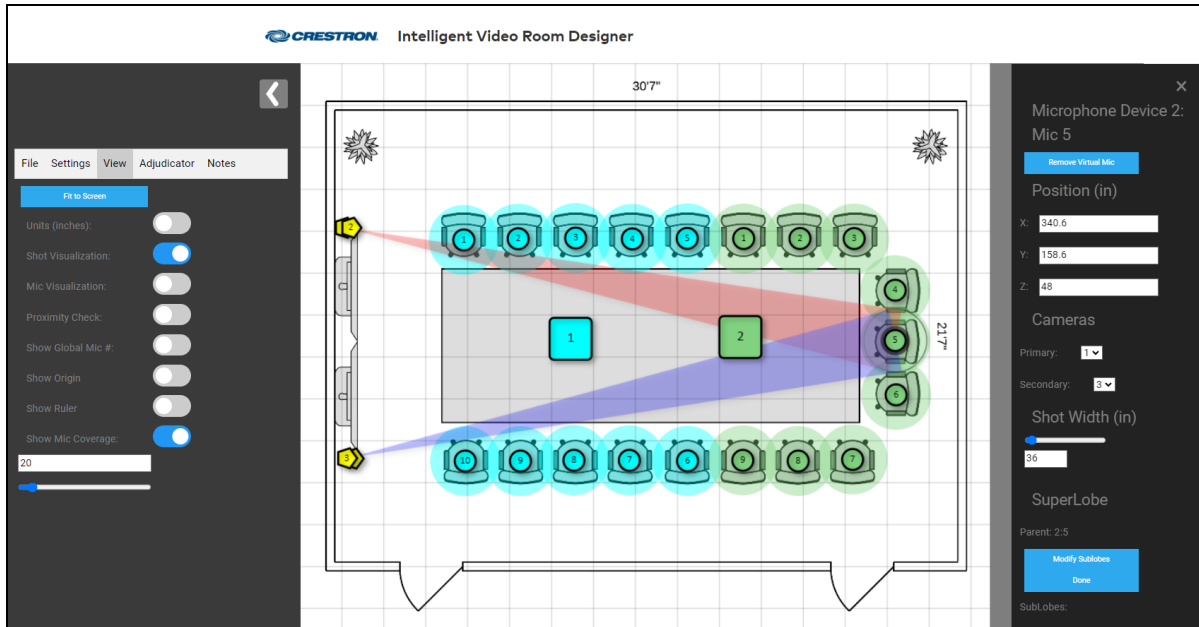

Key features include:

- Simple browser-based software
- Flexible tools available to design Intelligent Video Spaces
- Determine camera shots in real time with Shot Visualization
- Intuitive Proximity Check for optimizing participant positions and microphone placement
- Easily export .1brd files for fast Automate VX deployments

## Operates in a Web Browser

No software downloads or installations are required. Crestron Intelligent Video Room Designer Software operates in your browser of choice.

## Design Meeting Spaces

Upload a floor plan and set the scale, select seating locations and other common meeting participant positions. Use the simple drag and drop interface to determine ideal positions for cameras and microphones around the space. Select from the list of [System Components on page 8](#) for each device and determine which positions they each should cover.

## Configure Devices

Cameras and microphones can be configured with the browser-based interface. Use the desired microphone type and place it in the room, set speaking participant positions based off of the microphone used, and determine camera shots for the participant positions. Additionally, a default camera shot, adjudicators, and chairman mic position can be configured in Room Designer.

## Verify the System Design

View coverage zones of connected cameras and microphones. The Crestron Intelligent Video Room Designer Software indicates if any seats are too close together based on the device positions. Room Designer can easily determine ideal device placement.

## Export the Completed Meeting Space

Meeting spaces can be exported as an image for easy sharing or in a project file format. Project files can be reloaded into the Crestron Intelligent Video Room Designer Software or imported into Automate VX.

# IV-PROSERVICE-1B Features

1 Beyond Camera Systems Remote Professional Services provide support for commissioning your Automate VX voice-activated camera tracking solution.

The purchase of 1 Beyond Camera Systems Remote Professional Services (IV-PROSERVICE-1B) is required with the purchase of each Automate VX ([IV-SAM-VXS-1B](#)), Automate VX Pro ([IV-SAM-VXP-1B](#)), or Automate VX Plus ([IV-SAM-VXN-1B](#)) model. 1 Beyond Camera Systems Remote Professional Services is not available for purchase separately.

## Remote Professional Services

### 1 Beyond Camera Systems



#### Overview

Crestron 1 Beyond Camera Systems Remote Professional Services (IV-PROSERVICE-1B) provides dedicated technical support for the remote deployment of Automate VX Voice-Activated Multi-Camera Switching Solutions. With the purchase of IV-PROSERVICE-1B, Crestron's Remote Professional Services team helps you deploy and validate up to three Automate VX room configurations.

**NOTE:** 1 Beyond Camera Systems Remote Professional Services (IV-PROSERVICE-1B) includes a maximum of three (3) room configurations for each Automate VX system purchased. An additional charge will apply for systems requiring more than three room configurations. The Equipment Proposal will include the cost of deploying additional room configurations.

#### Purchasing Requirements

Crestron 1 Beyond Camera Systems Remote Professional Services must be purchased with each Automate VX ([IV-SAM-VXS-1B](#)), Automate VX Pro ([IV-SAM-VXP-1B](#)), or Automate VX Plus ([IV-SAM-VXN-1B](#)).

To schedule Crestron Remote Professional Services, complete the [Automate VX Professional Services Fulfillment Request Form](#).

Before submitting the [Automate VX Professional Services Fulfillment Request Form](#), customers must obtain an Equipment Proposal from Crestron's [Sales Support Services](#) team. The Equipment Proposal will include the Automate VX system(s), Crestron 1 Beyond cameras, other third-party equipment (such as microphones), and the number of proposed room configurations required for deployment. All requests for Remote Professional Services must reference the Equipment Proposal number and customers must acquire the complete camera system as outlined in the Equipment Proposal, including 1 Beyond Camera Systems Remote Professional Services.

**NOTE:** The purchase of Crestron Remote Professional Services and the provision of an Equipment Proposal is optional for Crestron Intelligent Video Certified Engineers (**IVC-E**). Refer to **Crestron Certifications** below for more information.

## Crestron Certifications

Crestron Intelligent Video Certified Designers (**IVC-D**) are not required to submit an Equipment Proposal when purchasing Remote Professional Services. A .1BRD design file, related room drawings, and IVC-D certification number are required when submitting the [Automate VX Professional Services Fulfillment Request Form](#). A design review may be required at the discretion of Crestron.

For Crestron Intelligent Video Certified Engineers (**IVC-E**) planning to self-deploy and self-validate a purchased Automate VX system, the purchase of Remote Professional Services is optional, subject to verification by Crestron.

To learn more about obtaining the **IVC-D** and **IVC-E** certifications, visit the [Crestron Technical Institute Portal](#) and view the Intelligent Video learning paths.

## Preinstallation Support

After purchase, the Crestron support team will review your proposed installation plan and recommend the optimal placement of the Automate VX system, Crestron 1 Beyond cameras, and other third-party equipment (such as microphones).

A dedicated team member will answer questions regarding system configuration and control system programming and help identify the resources required onsite for deployment.

## Remote Commissioning and Validation

Following installation, the Remote Professional Services team may need to connect remotely with your onsite team to help deploy the Automate VX solution. An AV technician is required onsite during this stage, as local configuration changes to auxiliary equipment such as microphones, Digital Signal Processors (DSPs), and control processors may be required.

Once the system is configured, the Remote Professional Services team may perform a complete validation of the camera tracking system remotely. Validation of the Crestron Automate VX system involves simulating a video conference call with your onsite AV technician to validate camera tracking, microphone sensitivity, lip-sync, API control from your control panel, and all other related functionality.

# System Design

This section aids in the design and implementation of an Automate VX system. Correct design and implementation are pivotal in creating a room with Automate VX, as these elements are required for a seamless video conferencing solution.

Additionally, the design and implementation of an Automate VX system should be replicated within the Room Designer software. Room Designer enables the system to communicate with microphones and cameras, along with creating the desired camera shots for the room. For more information about Room Designer, refer to [Room Designer on page 32](#).

**NOTE:** 1 Beyond Camera Systems Remote Professional Services ([IV-PROSERVICE-1B](#)) is required with the purchase of each Automate VX system. Professional Services provide pre-installation support, deployment, and validation of an Automate VX system. For more information, refer to [IV-PROSERVICE-1B Features on page 5](#).

Refer to the following sections for information on designing and implementing a room for Automate VX:

- [System Components](#)
- [Component Implementation](#)
- [Room Design](#)
- [Room Design Examples](#)



# System Components

An Automate VX system typically comprises cameras and microphones. Refer to the following sections for information on compatible cameras and microphones:

- [Cameras](#)
- [Intelligent Array Microphones](#)
- [Wired and Wireless Microphones](#)
- [Discussion Systems](#)

# Cameras

Crestron offers multiple cameras that fit the needs of a room in tandem with an Automate VX system. The following Crestron cameras are compatible with Automate VX.

## Crestron 1 Beyond Cameras

The following Crestron 1 Beyond cameras are compatible with Automate VX. Refer to the following sections for information on individual camera models. For more information on configuring Crestron 1 Beyond cameras, refer to the [Crestron 1 Beyond Camera Product Manual](#).

### IV-CAM-P12 Series

The [IV-CAM-P12-B](#) and [IV-CAM-P12-W](#) (hereafter referred to as "p12") are high quality PTZ cameras that output up to 1080p60 resolution video. These cameras are ideal for meetings in medium to large spaces where one camera needs to capture several areas of the room.

### IV-CAM-P20 Series

The [IV-CAM-P20-B](#) and [IV-CAM-P20-W](#) (hereafter referred to as "p20") are high quality PTZ cameras that output up to 1080p60 resolution video. These cameras are ideal for meetings in large to extra large spaces where one camera needs to capture several areas of the room.

### IV-CAM-I12-B

The [IV-CAM-I12-B](#) (hereafter referred to as "i12") is a high quality intelligent PTZ camera that uses visual AI to automatically track or frame meeting participants. The IV-CAM-I12-B is ideal for group framing meeting participants in medium to large conference rooms, and presenter tracking in medium sized training rooms and classrooms.

### IV-CAM-I20 Series

The [IV-CAM-I20-B](#) and [IV-CAM-I20-W](#) (hereafter referred to as "i20") are high quality intelligent PTZ cameras that use visual AI to automatically track or frame a presenter. These cameras are ideal for presenter tracking in large to extra large sized training rooms and classrooms, and group tracking meeting participants in large to extra large conference rooms.

## Legacy 1 Beyond Cameras

Legacy 1 Beyond cameras are still compatible with Automate VX. Refer to the following sections for information on individual discontinued camera models.

### IV-CAMP12Z-12 Series

The [IV-CAMP12Z-12-N-W-1B](#), [IV-CAMP12Z-12-N-SLVR-1B](#), [IV-CAMP12Z-12-W-1B](#), and [IV-CAMP12Z-12-SLVR-1B](#) (hereafter referred to as "PTZ-IP 12") are high quality PTZ IP cameras that output up to 1080p60 resolution video via the 3G-SDI or HDMI® ports. These cameras are ideal when participants will be closer to the camera. For more information on configuring a IV-CAMP12Z-12 camera, refer to the [1 Beyond PTZ Series Product Manual](#).

## IV-CAMPTZ-20 Series

The [IV-CAMPTZ-20-N-W-1B](#), [IV-CAMPTZ-20-N-SLVR-1B](#), [IV-CAMPTZ-20-W-1B](#), and [IV-CAMPTZ-20-SLVR-1B](#) (hereafter referred to as "PTZ-IP 20") are high quality PTZ IP cameras that output up to 1080p60 resolution video via the 3G-SDI or HDMI® ports. These cameras are ideal when participants will be further from the camera. For more information on configuring a IV-CAMPTZ-20 camera, refer to the [1 Beyond PTZ Series Product Manual](#).

## IV-CAMA3-20 Series

The [IV-CAMA3-20-N-W-1B](#), [IV-CAMA3-20-N-SLVR-1B](#), [IV-CAMA3-20-W-1B](#), and [IV-CAMA3-20-SLVR-1B](#) (hereafter referred to as "AutoTracker") AutoTracker™ 3 series cameras are high-quality PTZ cameras that automatically track and frame a presenter based on facial and motion detection. For more information on configuring a IV-CAMA3-20 camera, refer to the [1 Beyond AutoTracker™ 3 Presenter Tracking Camera Product Manual](#).

## Camera Comparison

The following table shows a comparison of Crestron intelligent video cameras:

Features	p12	p20	i12	i20
Optical Zoom	12x	20x	12x	20x
Field of View (FOV)	67.68°	56.45°	67.68°	56.45°
Maximum Distance for 3 ft Wide Camera Shot	28 ft	60 ft	28 ft	60 ft
Presenter Tracking Enabled	No	No	Yes	Yes
Can be Inverted	Yes	Yes	No	No
SDI Output Available	Yes	Yes	Yes	Yes
HDMI Output Available	Yes	Yes	Yes	Yes
NDI Output Available	Yes	Yes	No	Yes

For more information on which cameras are best suited for a room design, refer to [Camera Implementation](#).

# Intelligent Array Microphones

Intelligent array microphones are most commonly used with Automate VX. Multiple intelligent array microphones can be positioned around the room to gather audio position data from speaking participants. Automate VX uses this data to switch camera shots to ensure that the speaking participant is accurately captured.

When designing an Automate VX project, intelligent array microphones should be used if possible. To determine if an intelligent array microphone can provide accurate positional data for a speaking position, perform a **Proximity Check** in Room Designer with the desired microphone device. For more information on Proximity Check, refer to [Proximity Check on page 51](#).

The following intelligent ceiling array microphones are compatible with Automate VX:

- Shure® MXA920
- Sennheiser® TCC2
- Sennheiser TCCM
- Yamaha® ADECIA RM-CG
- Audio Technica® ATND1061 (beta)
- Shure MXA910

**NOTE:** The Shure MXA910 uses a lobe architecture rather than XYZ positional data for audio input. Due to this, the Shure MXA910 is limited to eight **Virtual Mic** positions in Room Designer. For more information on configuring a Shure MXA910 in Room Designer, refer to [Model on page 70](#)

The following intelligent table array microphones are compatible with Automate VX:

- Shure MXA310

# Wired and Wireless Microphones

Gooseneck microphones, tabletop microphones, button microphones, and other wired microphones that do not provide positional data when detecting audio are compatible with Automate VX. Wireless microphones such as lavalier microphones are compatible with Automate VX as well. Wired and wireless microphones require a DSP (Digital Signal Processor) to operate with Automate VX.

**NOTE:** Pendant microphones are not compatible with Automate VX.

## DSPs

A DSP is required if wired or wireless microphones that do not provide positional data are used with Automate VX. These microphones are routed through a DSP as either gated on when detecting audio or gated off when no audio is detected. Automate VX then uses these gating properties to determine which camera shots should be shown.

The following DSPs are compatible with Automate VX:

**NOTE:** The channel limits listed for each DSP are the maximum audio channels that Automate VX can use with the DSP. For more information about DSPs and configuring them to communicate with Automate VX, refer to [DSP Configuration on page 135](#).

- Shure Intellimix™ Room
  - 8 or 16 channel limit depending on the software license used
- Shure P300
  - 8 channel limit
- Biamp TesiraFORTÉ™
  - 32 channel limit
- Biamp Tesira™ SERVER
  - 32 channel limit
- QSC Q-SYS™ Core 110F
  - Unlimited channels
- QSC Q-SYS Core 510i
  - Unlimited channels
- QSC Q-SYS Core 610
  - Unlimited channels

## Discussion Systems

Discussion systems usually contain a microphone, speaker, and central control units. A discussion system reports whether its microphones are active or inactive. There are two types of discussion systems: push-to-talk and voice-activated. Both system types can be wired or wireless.

The following discussion systems are compatible with Automate VX:

- Shure MXCW
- TAIDEN® Conference System

# Component Implementation

Automate VX relies on a combination of cameras and microphones to properly operate, and the location of these peripherals is crucial. The following sections provide information on implementing cameras and microphones in a room with Room Designer for Automate VX. For more information about Room Designer, refer to [Room Designer on page 32](#).

This section provides the following information:

- [Camera Implementation](#)
- [Microphone Implementation](#)

# Camera Implementation

Camera usage in a room is dependent on the room itself (shape, orientation, and purpose of the room), but there are general guidelines to implementing cameras. The following sections provide information on camera room requirements.

## Camera Quantity

Two p12 or p20 cameras should be placed as close as possible to one another to ensure fast and clean video shots, and to avoid camera panning. This setup also ensures that an extra camera will be available to support multiple speaking participants.

Typically only one i12 or i20 camera is required in a room, as it is best used for presentation areas. Use i12 and i20 cameras only when presenter tracking is necessary for the room configuration.

## Camera Placement

Cameras should always be placed facing towards where participants and presenters are located. This often means placing cameras on top of or next to monitors that are used within video conferencing applications. Ensure that there are no obstructions blocking the camera shot.

**NOTE:** All camera placements require proper lighting for the video output. 500 lux is the recommended minimum lighting for a camera shot.

## NDI and SDI

Crestron 1 Beyond cameras that are compatible with Automate VX have SDI or NDI outputs available. NDI enabled cameras are recommended if the room has more than 7 cameras, or has multiple Automate VX units. Otherwise, SDI or NDI outputs can be used interchangeably depending on preference. For more information on Crestron 1 Beyond cameras that are NDI enabled, refer to [Camera Comparison on page 10](#).

**CAUTION:** Do not use NDI and SDI outputs in conjunction with one another. Doing so will negatively impact the camera switching performance of Automate VX.



# Microphone Implementation

Microphone usage is dependent on the room itself (shape, orientation, and purpose), but there are general guidelines for implementing microphones. The following sections provide information on microphone room requirements.

## Microphone Quantity

The microphone quantity required for a room depends on which microphones are used. For intelligent microphone arrays, determine the microphone quantity by using the **Proximity Check** setting in Room Designer on Automate VX. **Proximity Check** will give an accurate assessment of where intelligent microphone arrays should be placed in a room for adequate speaking participant coverage.

For microphones that are not intelligent microphone arrays, the microphone quantity required is equal to the number of speaking participants in the room. For microphones that require a DSP, ensure the DSP has a sufficient channel count to meet the microphone quantity. For more information on DSP channel limits, refer to [DSPs on page 12](#).

## Microphone Placement

The microphone placement for a room depends on which microphones are used. For intelligent microphone arrays, optimal placement can be determined by using the **Proximity Check** setting in Room Designer on Automate VX. **Proximity Check** displays the range of intelligent microphone arrays, and will notify when a microphone is not in speaking range.

When using a lavalier microphone, use an AutoTracker to follow the presenter's movement. For all other microphones used with Automate VX, microphones should be placed where speaking participants are located in the room. If a DSP is present, the DSP location does not affect the performance of Automate VX.

# Room Design

Automate VX functions in a variety of spaces; however, these spaces often have specific considerations that need to be addressed. The following sections provide information on the types of spaces where Automate VX systems are commonly deployed and the design considerations required for each space.

## Extra Large Rooms

Extra large rooms hold 12 or more participants. Automate VX accommodates extra large meeting space configurations where participants are either facing one monitor or facing various monitors throughout the room. Depending on the size of the room, more cameras and microphones may be required to provide speaker tracking for all participants.

## Multipurpose Spaces

If the room is a multipurpose space (such as a training room where furniture will be moved and regularly reconfigured), account for multiple furniture layouts with appropriate camera and microphone placement. A multipurpose space may require additional cameras and/or microphones compared to a room with a static furniture layout. This ensures that cameras are always facing participants regardless of furniture layout.

**TIP:** Use a physical indicator in the room such as a marking on the ceiling or floor to accurately position furniture. Automate VX requires furniture to be placed consistently for each respective room configuration.

## High Value Rooms

High value rooms are meeting spaces that are considered important and where custom video conferencing is required. Automate VX provides a custom tailored experience for these spaces, allowing for dynamic compositions and camera shots. Examples of high value rooms include but are not limited to a CEO's boardroom or a client-facing location.

The intended usage of a high value space can change the required amount of cameras significantly. For example, if side-by-side compositions are used, ensure that speaking participants can be presented simultaneously.

## Divisible Spaces

Divisible spaces are very large rooms that can be sectioned off into two or more rooms, often with folding walls or sliding doors. These rooms have multiple configurations that change depending on the event and number of participants. They can also include multiple presentation areas and multiple furniture layouts.

To ensure that all presentation and participant areas are captured with speaker tracking video, one Automate VX system should be used for each room within the divisible space. Each divisible space that uses an Automate VX requires additional cameras and microphones.

Crestron NDI enabled cameras are recommended for divisible spaces because they can connect to multiple Automate VX systems. For more information on Crestron NDI enabled cameras, refer to [Cameras on page 9](#).

## Training and Learning Spaces

Training and learning spaces are rooms where there is an audience and a main presentation area. These are typically classrooms where a presenter stands in front of a class of students. Automate VX provides the ability to track a presenter's movements while camera switching to the students when they speak. A side-by-side composition is common with training and learning spaces, where the presenter and a speaking student can be seen simultaneously.

An i20/i12 camera is typically positioned at the opposite side of the room facing the presentation area, enabling the presenter to be accurately tracked. p12 and/or p20 cameras should be positioned at the presentation side of the room facing the students.

Microphones should be positioned within the space to accommodate a moving presenter and stationary students. A lavalier microphone is recommended for the presenter, while intelligent ceiling array microphones are recommended for the student section.

# Room Design Examples

This section provides the following room design examples using Automate VX, cameras, and microphones:

- [Large Boardroom with Standard Monitors on page 21](#)
- [High Value Boardroom with Table Mics on page 24](#)
- [Divisible Room on page 27](#)

## Room Designer Key

Refer to the following sections for information on what Room Designer software symbols represent in the room design examples.

### Camera Device

Camera Devices are indicated in Room Designer as pentagon-shaped nodes. PTZ-IP 12, PTZ-IP 20, p12, and p20 cameras are yellow, whereas AutoTracker 3, i12, and i20 cameras are orange. For more information on Camera Devices, refer to [Camera Device Configuration on page 59](#).

#### PTZ-IP 12 and PTZ-IP 20 Camera Device



#### AutoTracker 3 Camera Device



## Microphone Device

Microphone Devices are indicated in Room Designer as square-shaped nodes. Microphone Devices represent intelligent microphone arrays, discussion systems, and DSPs. The color of the Microphone Device is associated with its number (Microphone Device 1 is blue, Microphone Device 2 is green, and so forth). For more information on Microphone Devices, refer to [Microphone Device Configuration on page 67](#).

### Microphone Device



## Virtual Mic Location

Virtual Mic locations are indicated in Room Designer as circle-shaped nodes. Virtual Mics represent speaking participant positions in Room Designer. The color of the Virtual Mic is associated with the Microphone Device that it is reporting to (blue Virtual Mics report to Microphone Device 1, green Virtual Mics report to Microphone Device 2, and so forth). For more information on Virtual Mics, refer to [Virtual Mic and Blocking Zone Configuration on page 78](#).

### Virtual Mic Location



# Large Boardroom with Standard Monitors

The large boardroom in the example below has a rectangular table with participants seated along both long edges of the table, and at one chairman position at the end (6). The left wall has two side-by-side monitors.

## Large Boardroom with Standard Monitors

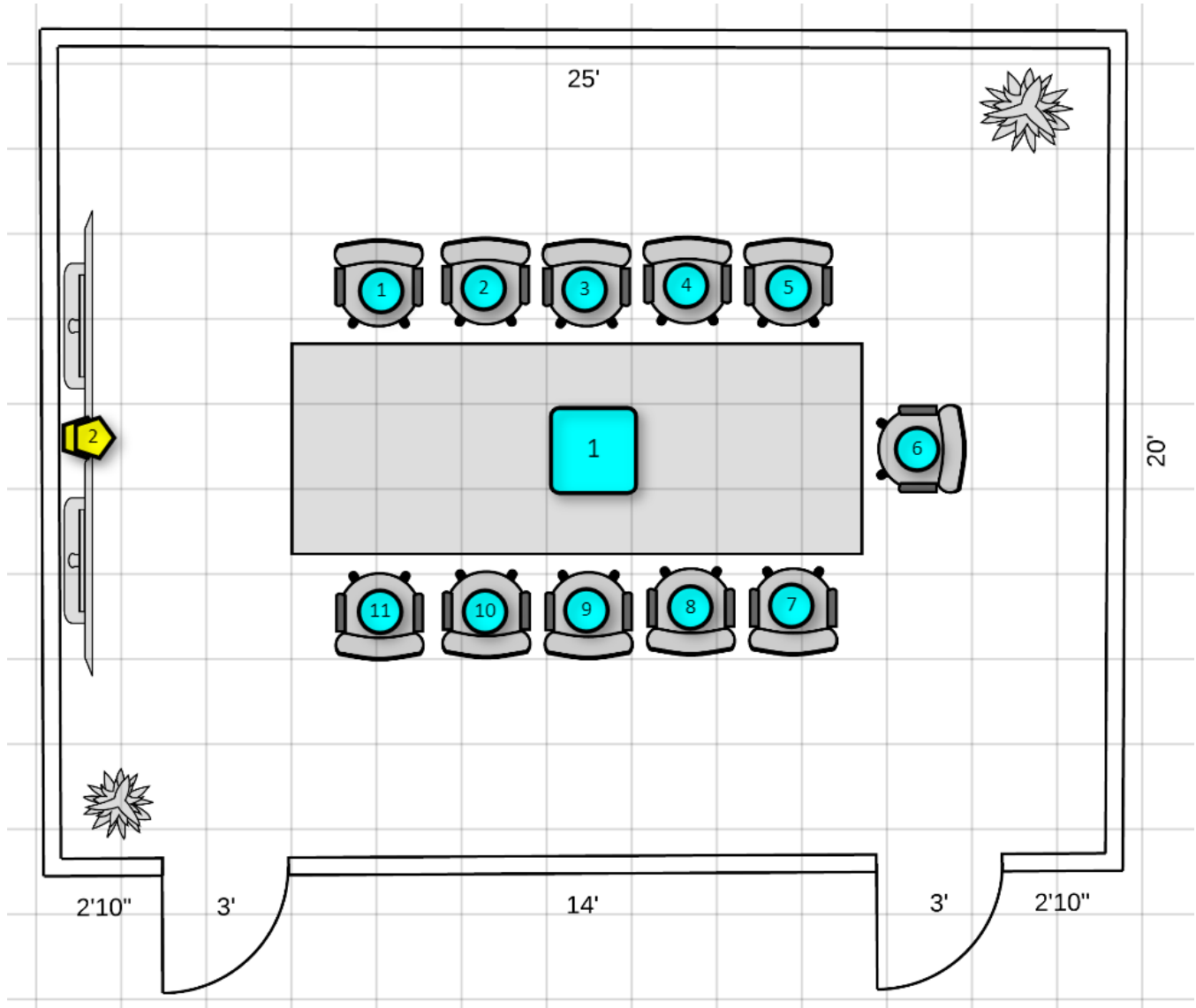

Refer to the [Room Designer Key](#) on page 19 for information on the numbered symbols.

The following Automate VX solution is recommended for this room:

System	Cameras	Microphones	Other Devices
1 Automate VX2 (IV-SAM-VX2-S)	2 p12 cameras (IV-CAM-P12-B)	1 intelligent ceiling array microphone	1 Conferencing codec (UC-Engine)
			1 SDI to USB converter
			1 Network Switch
			2 Displays

Refer to the following sections for information about the Automate VX solution recommended for this room.

## Cameras

Two p12 cameras are placed in-between the two monitors at the end of the room. The cameras in this example are mounted on top of each other with Universal Mounting Brackets ([IV-CAMA-UMB](#)). These cameras are placed here to properly frame all participants in the room.

p12 cameras are used in this configuration instead of p20 cameras as their wider field of view ensures all participants are framed properly.

## Automate VX System

An Automate VX2 system (IV-SAM-VX2-S) is used for this room. A standard Automate VX system is recommended since there are only two cameras in the room.

## Microphones

One intelligent ceiling array microphone is placed in the middle of the room over the rectangular table. This ensures that all participants are accurately detected by the microphones. To check the audio detection range of the microphone, use the **Proximity Check** feature in Room Designer.

## Network Switch

One network switch is used for this room. The network switch allows the cameras, microphone, and Automate VX to communicate with each other through the network. The network switch also provides power (PoE+) to the cameras and microphone.

## Conferencing Codec

One conferencing codec is used for this room. The conferencing codec allows the Automate VX video and microphone audio to be outputted to a conferencing software such as Microsoft Teams® software. One SDI to USB converter is required to use the conferencing codec.

# Application Diagram

The following diagram shows how the recommended Automate VX solution is connected.

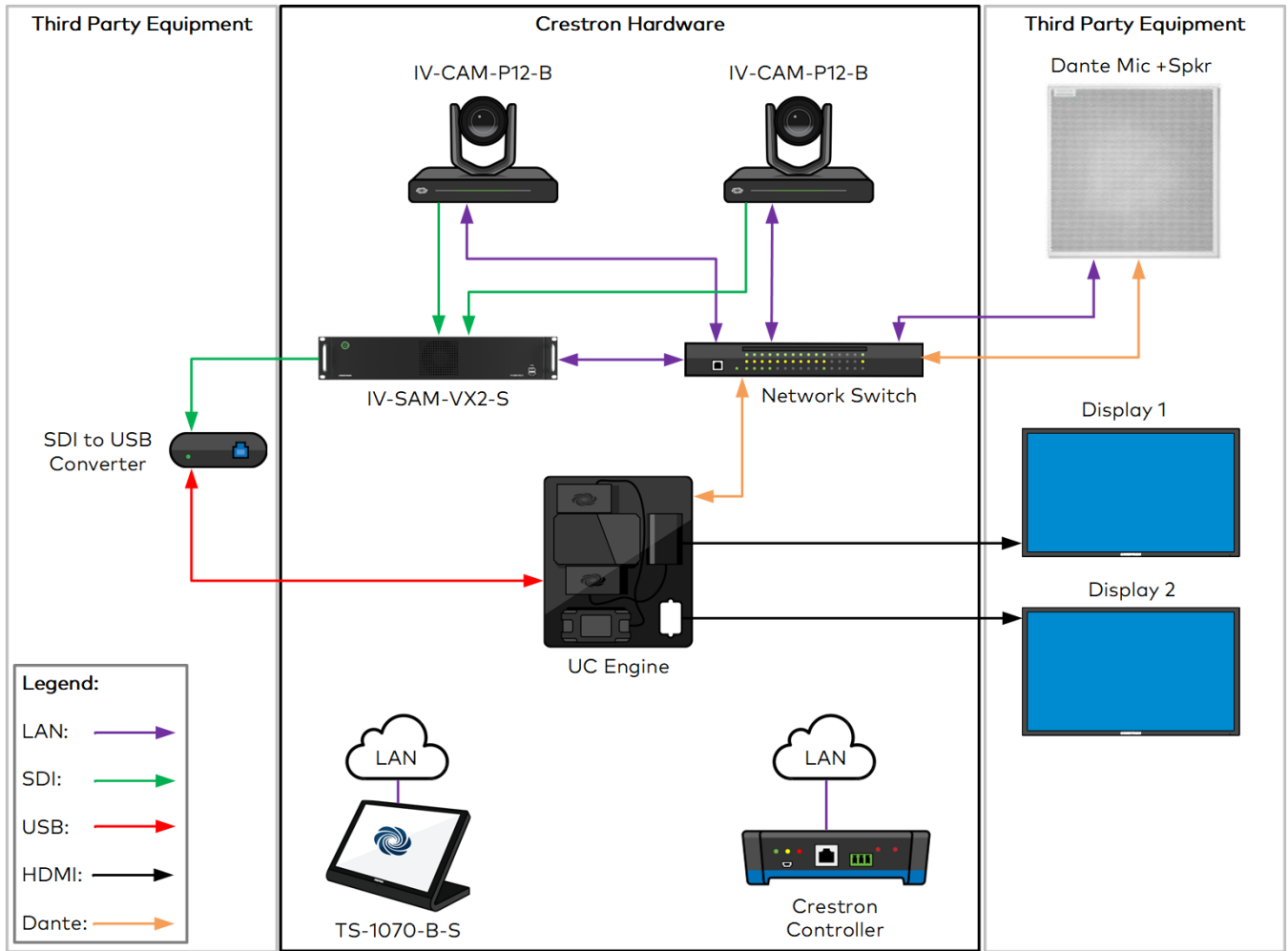



# High Value Boardroom with Table Mics

The high value boardroom in the example below has a circular table with seating all around. The display in this room can be moved and is not in a fixed location.

High Value Boardroom with Table Mic

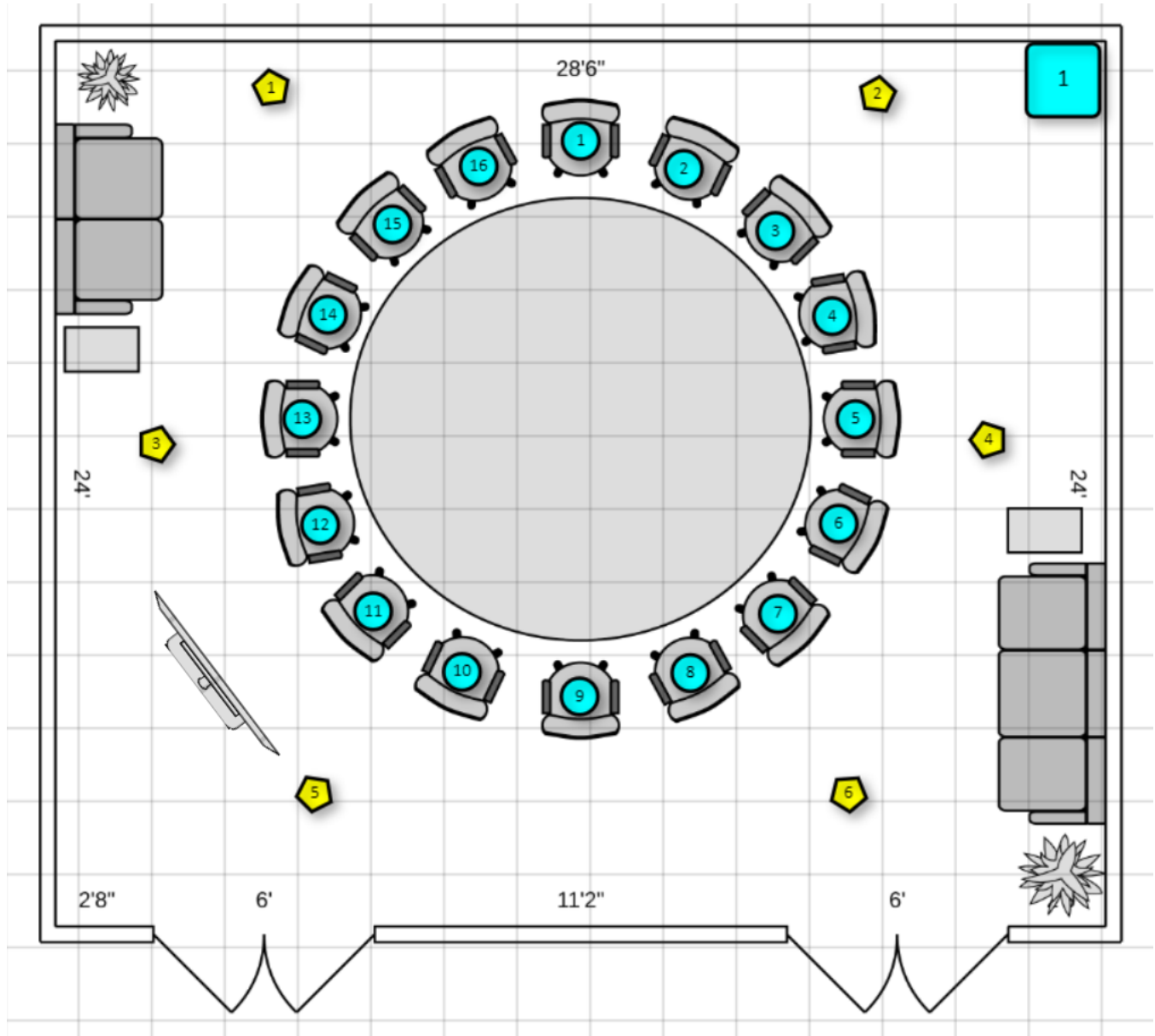

Refer to the [Room Designer Key](#) on page 19 for information on the numbered symbols.

The following Automate VX solution is recommended for this room:

System	Cameras	Microphones	Other
1 Automate VX2 Pro (IV-SAM-VX2-P)	6 p12 cameras (IV-CAM-P12-B)	16 gooseneck microphones	1 Conferencing codec (UC-Engine)
		1 compatible DSP	1 SDI to USB converter
			1 Network Switch
			1 Display

Refer to the following sections for information about the Automate VX solution recommended for this room.

## Cameras

Six p12 cameras are placed in a hexagonal shape above the perimeter of the table. The cameras are inverted with Universal Mounting Brackets ([IV-CAMA-UMB](#)) with one camera per location.

**NOTE:** Due to the placement of cameras and seating around the table, it is not required to have two cameras placed at the same position.

p12 cameras are used in this configuration instead of p20 cameras as their wider field of view ensures all participants are caught in the camera shot.

## Automate VX System

An Automate VX2 Pro system (IV-SAM-VX2-P) is used for this room. The Pro system is required due to there being six cameras connected through SDI.

## Microphones

Gooseneck microphones are located at each seat around the table. Each Virtual Mic position represents an individual gooseneck microphone, and the mics are all connected through a DSP that communicates with Automate VX.

The DSP is indicated by the Microphone Device labeled 1 (1) in the top right corner of the Room Designer project. The DSP's location in Room Designer is not important as Automate VX only needs the gating information from the DSP. For more information about DSPs, refer to [DSPs](#).

## Network Switch

One network switch is used for this room. The network switch allows the cameras, DSP, and Automate VX to communicate with each other through the network. The network switch also provides power (PoE+) to the cameras and microphone.

## Conferencing Codec

One conferencing codec is used for this room. The conferencing codec allows the Automate VX video and DSP audio to be outputted to a conferencing software such as Microsoft Teams software. One SDI to USB converter is required to use the conferencing codec.

# Application Diagram

The following diagram shows how the recommended Automate VX solution is connected.

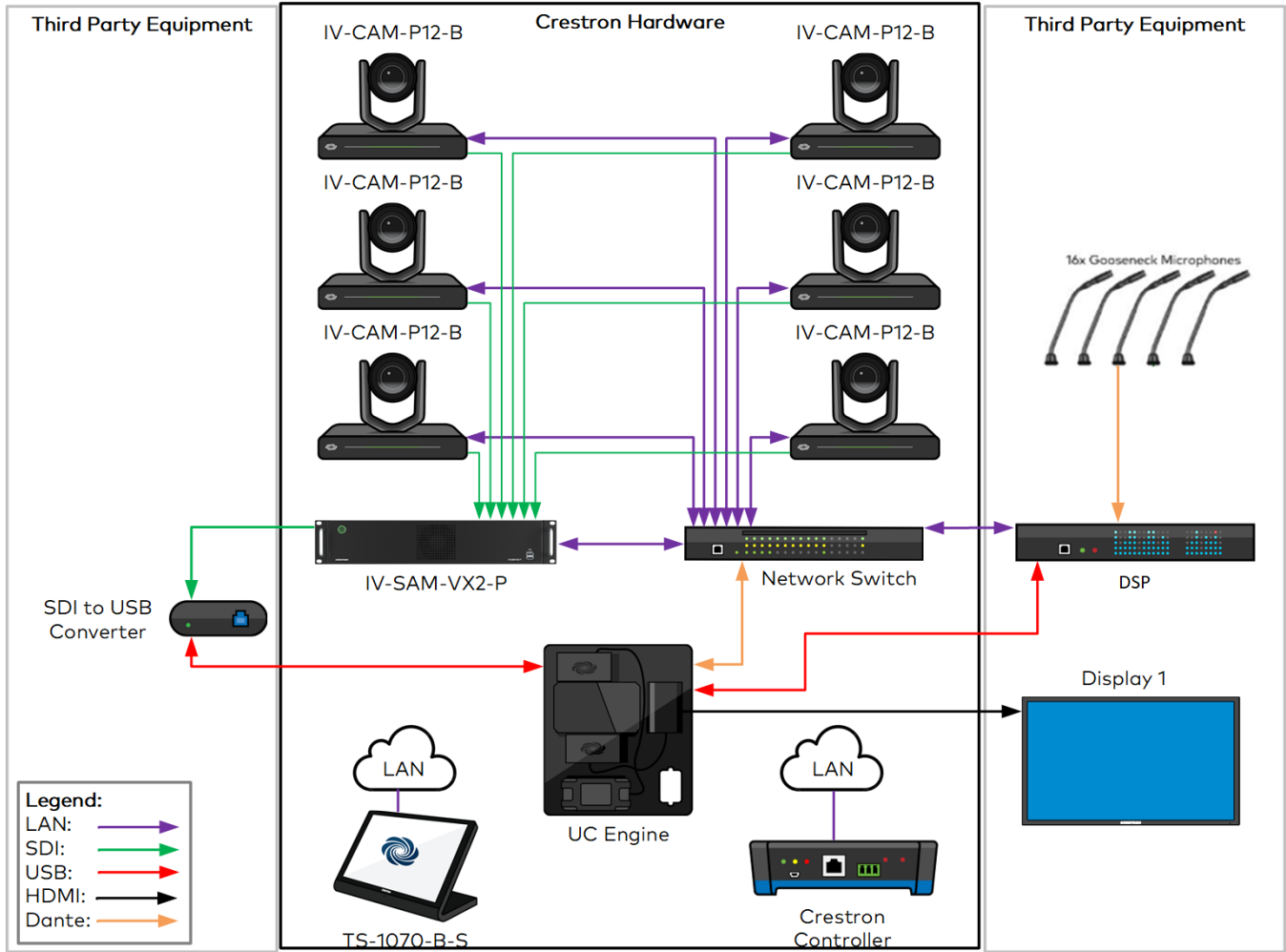

# Divisible Room

The divisible room in the example below is separated into two main rooms, both functionally similar. The room has a collapsible folding wall, and the individual spaces are used as standalone rooms in one configuration.

The other configuration for this room has the folding wall collapsed and both spaces are used as one large room. In both halves of the divisible room, the majority of the participants are seated in rows facing towards a presentation space with a podium.

## Divisible Room

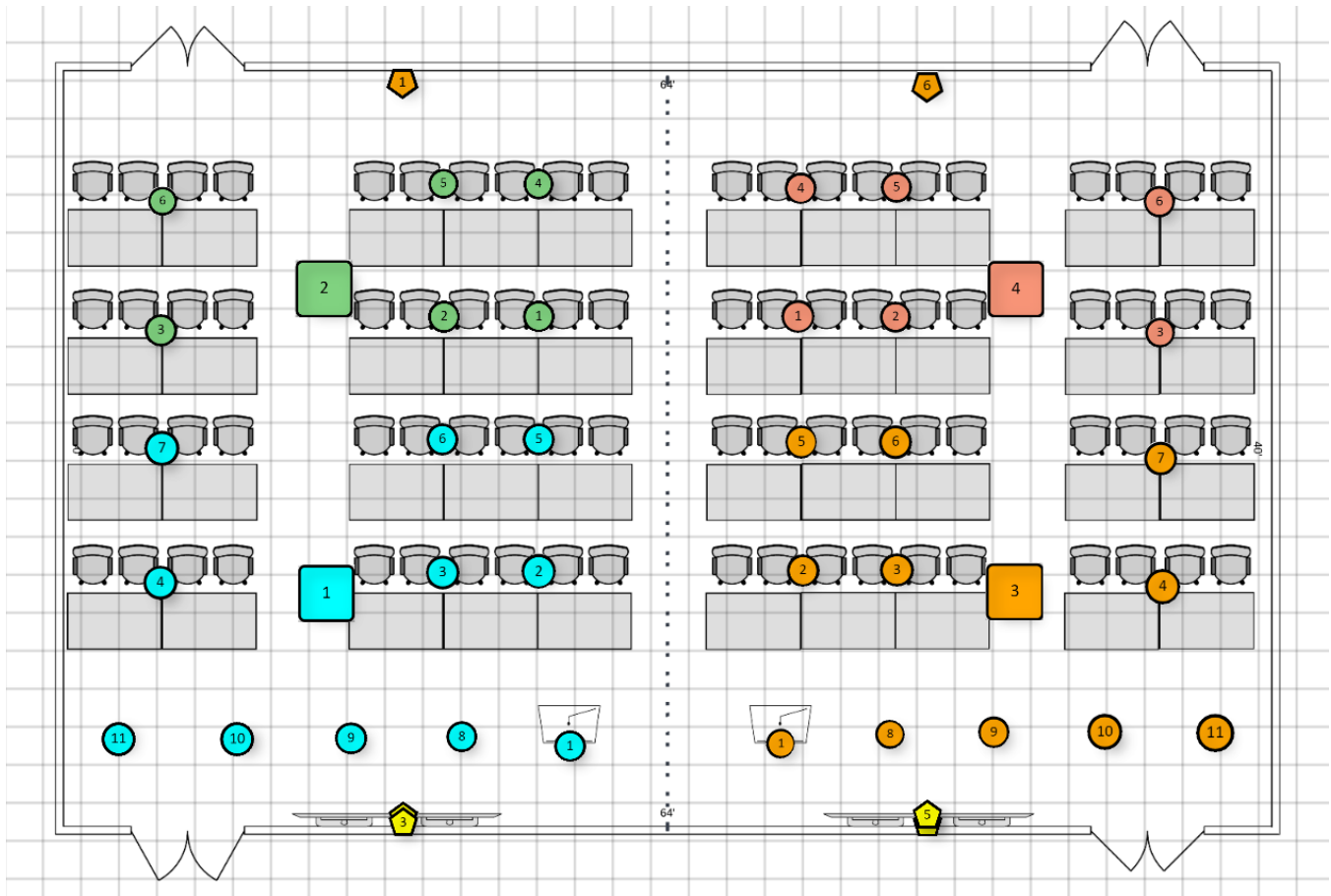

Refer to the [Room Designer Key](#) on page 19 for information on the numbered symbols.

The following Automate VX solution is recommended for this room:

System	Cameras	Microphones	Other
2 Automate VX2 Pro (IV-SAM-VX2-P)	4 p20 cameras (IV-CAM-P20-B)	4 intelligent ceiling array microphones	2 Conferencing codecs (UC-Engine)
	2 i20 cameras (IV-CAM-I20-B)		2 SDI to USB converters
			2 Network Switches
			2 Displays

Refer to the following sections for information about the Automate VX solution recommended for this room.

## Cameras

There are two types of cameras used in this room, refer to the following sections for information on the camera implementation for this room.

**NOTE:** Cameras are connected to the Automate VX2 Pro systems as NDI inputs instead of SDI for this room. This allows cameras to be connected to individual Automate VX2 Pro systems in each divisible space, and when the spaces are combined into a single room, the cameras can be connected to a single Automate VX2 Pro system.

### p20 Cameras

Four p20 cameras are used for this room. Each space within the divisible room has two p20 cameras. Each room has the cameras on the presenter side facing towards the audience. These cameras are mounted on top of each other with Universal Mounting Brackets ([IV-CAMA-UMB](#)) above the monitors in the presenter space.

p20 cameras are used instead of p12 cameras as their longer optical range ensures that participants are properly framed in the camera shot.

### i20 Cameras

Two i20 cameras are used in this room. Each half of the divisible space has one i20 camera, and both spaces have the cameras on the audience side facing towards the presenter space. These cameras are mounted high enough that the audience does not interfere with the camera shot of the presenter space.

i20 cameras are used because the presentation area in the front of the room requires a presenter tracking camera shot. This allows the presenter to move around the presentation area while still being properly framed in the camera shot.

## Automate VX Systems

Two Automate VX2 Pro systems (IV-SAM-VX2-P) are used for this room. Two Automate VX2 Pro systems are required to support camera operation for both of the divisible spaces (as two separate systems) and the larger combined room (as one unified system). For the combined room, one of the two Automate VX2 Pro systems will operate as the primary system.

## Microphones

Four intelligent ceiling array microphones are used in the divisible room. Two microphones are placed in each of the divisible spaces, ensuring that both the audience seated at the tables and the presentation area are able to be properly detected by the microphones. **Proximity Check** in Room Designer should be used to determine the optimal placement of the intelligent ceiling array microphones.

### Virtual Mic Positions

Virtual Mics are not placed directly at each seat because a wide angle shot of the audience is desired. To achieve this, Virtual Mics are placed at tables so that four participants are visible in the camera shot.

#### Camera Shot Example 1

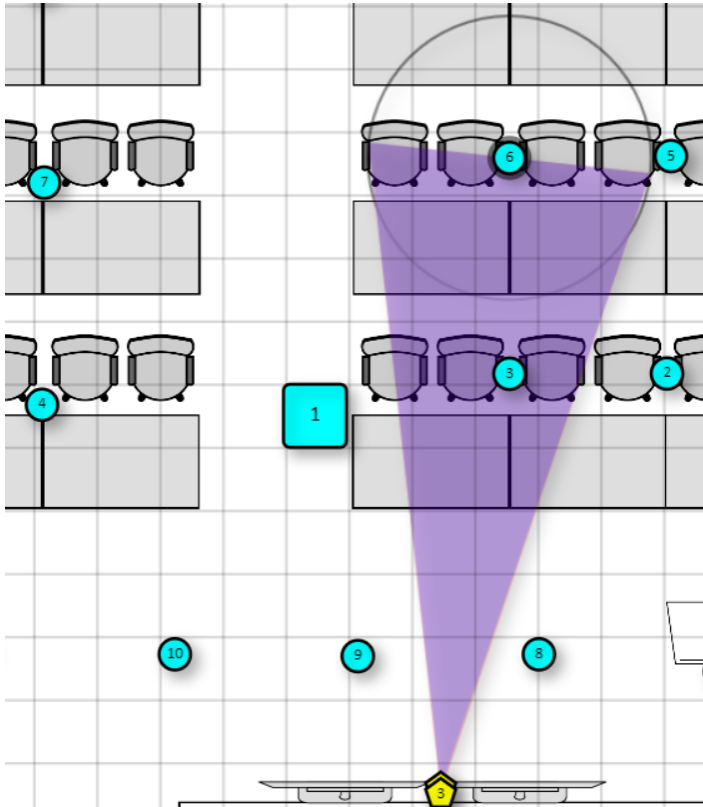

## Camera Shot Example 2

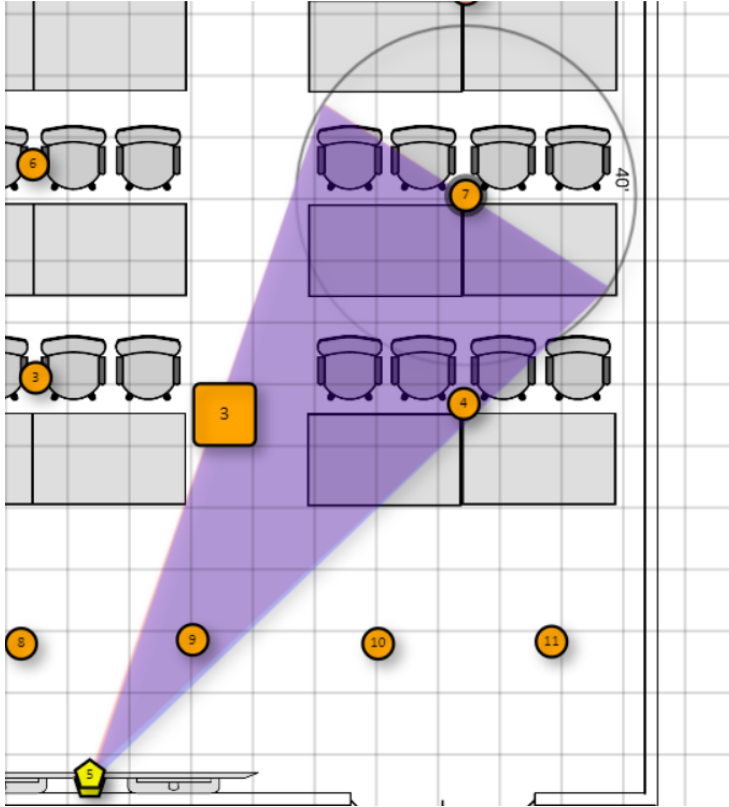

Five Virtual Mics are placed along the presentation area in the front of each space of the divisible room. This ensures that whenever audio is detected in the presentation area, the AutoTracker camera at the back of the room switches to the presenter.

## Network Switches

Two network switches are used for this room. The network switch allows the cameras, microphones, and Automate VX to communicate with each other through the network. The network switch also provides power (POE+) to the cameras and microphone.

The two network switches are connected to one another, allowing for communication between them. This provides the ability to combine the microphones and cameras of each room when the divisible wall is collapsed.

## Conferencing Codecs

Two conferencing codecs are used for this room. The conferencing codec allows the Automate VX video and DSP audio to be outputted to a conferencing software such as Microsoft Teams software. Each space receives a conferencing codec to ensure that can be used independently in their respective spaces. Two SDI to USB converters are required to use the conferencing codecs.

# Application Diagram

The following diagram shows how the recommended Automate VX solution is connected.

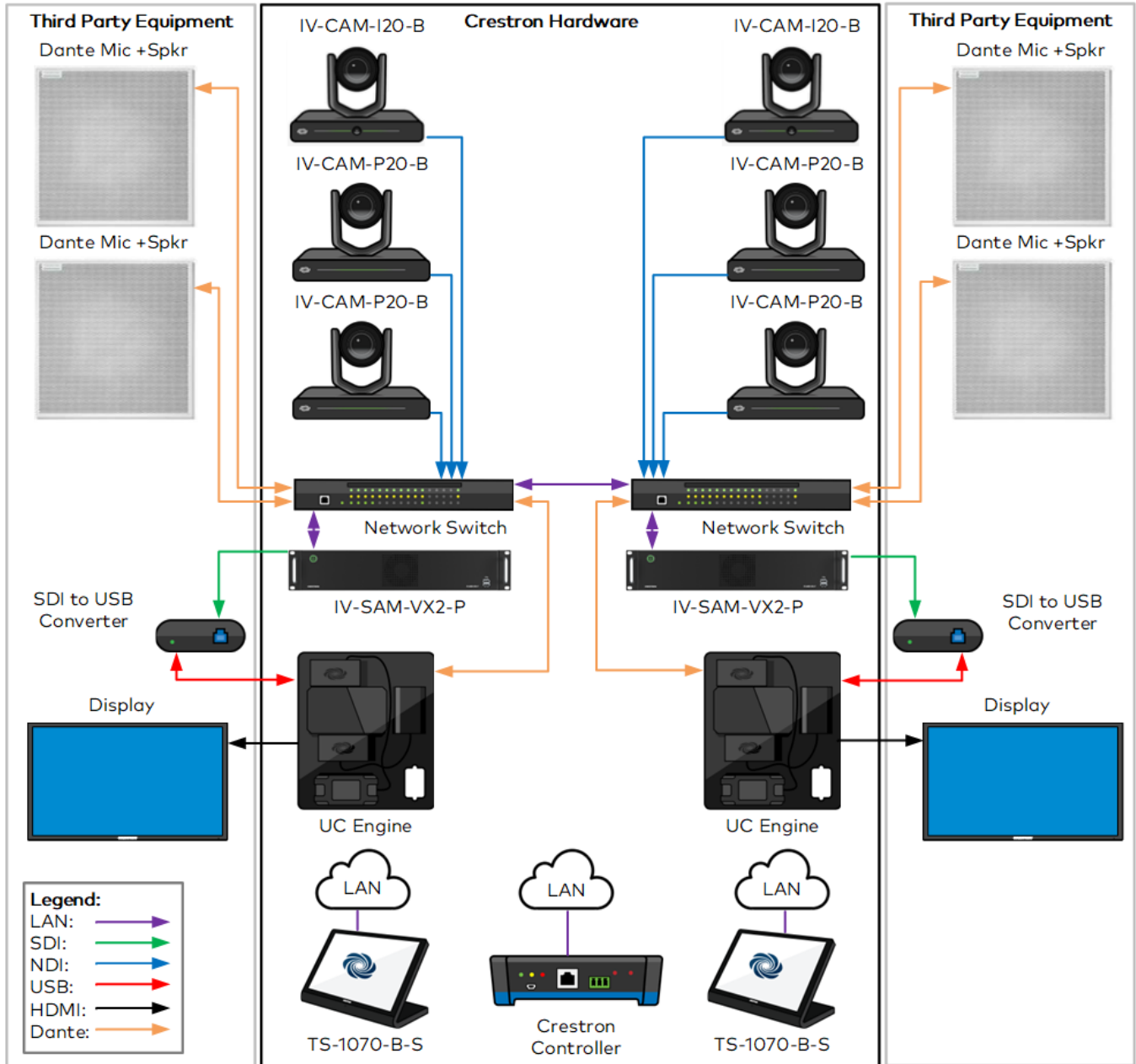



# Room Designer

Automate VX contains the Room Designer tool that uses the scaled floor plan (in the form of an image) to create a framework for how the Automate VX operates. Automate VX relies on audio gating or positional information provided by third-party devices to determine where an active speaking participant is located in a room. Room designer links third-party audio logic information to camera behavior.

**NOTE:** Some Room Designer features are only available on the Automate VX system and not on the web version of Room Designer. Settings that are only available on Automate VX systems are indicated throughout this section.

Refer to the following sections for information on how to configure a project within Room Designer:

- [Access the Web Configuration Interface](#)
- [Floor Plan Upload](#)
- [Upload a Project](#)
- [Room Designer Settings](#)
- [Camera Device Configuration](#)
- [Microphone Device Configuration](#)
- [Virtual Mic and Blocking Zone Configuration](#)
- [AutoSwitch Preview](#)

# Access the Web Configuration Interface

To access the web configuration interface for the Automate VX, open the browser on Automate VX. The web configuration interface loads automatically.

To access the web configuration interface from a different device:

1. Enter the IP address of the Automate VX with port 3579 appended to the address (for example, "10.1.10.31:3579")

A login page is displayed.

## Login Page

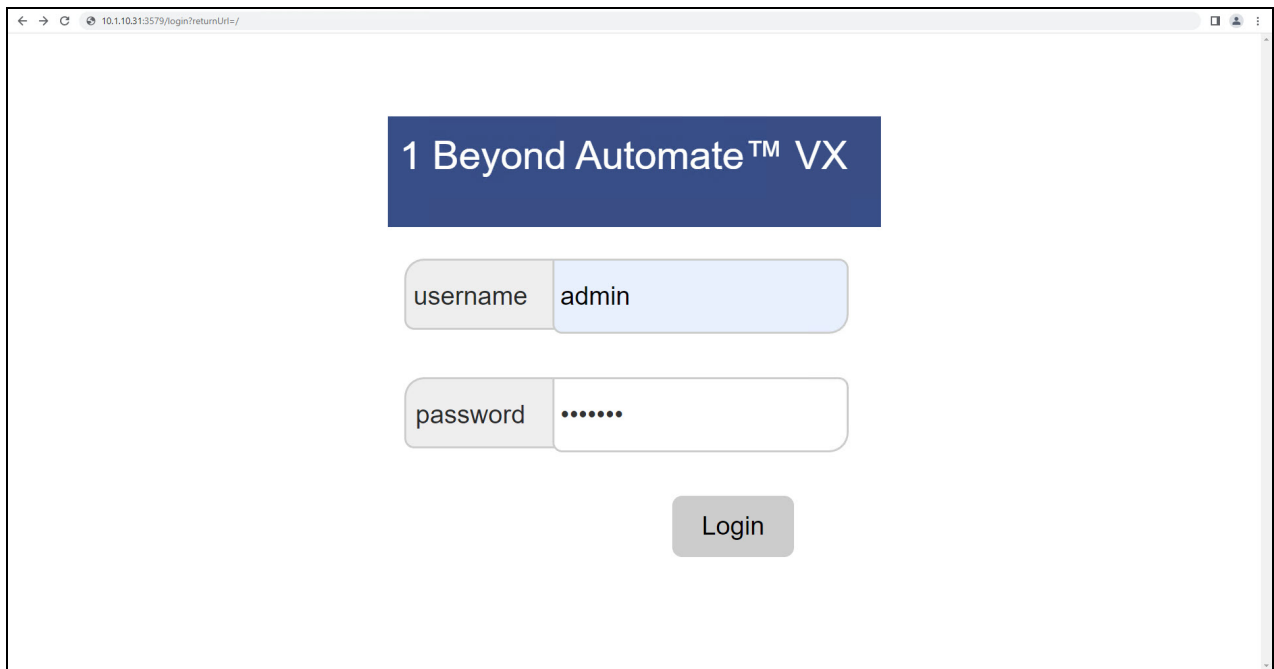

The screenshot shows a web browser window with the URL "10.1.10.31:3579/login?returnUrl=/". The main heading is "1 Beyond Automate™ VX". Below the heading are two input fields: "username" with the value "admin" and "password" with masked characters ".....". A "Login" button is positioned below the password field.

1. Enter the following login credentials:

- **username:** admin
- **password:** 1beyond

**NOTE:** The "1beyond" password above will only work on the first login to Automate VX. Automate VX will prompt you to create a new password following the initial login.

2. Select **Login**.

**NOTE:** The login credentials above are for the admin user only. If additional users are added to the system, use their respective login credentials to access the system. For more information, refer to [Add User on page 122](#).

The web configuration interface is displayed with the **Main** tab open by default. To access Room Designer from the **Main** tab, select the pencil icon in the top right of the menus.

### Main View to Room Designer

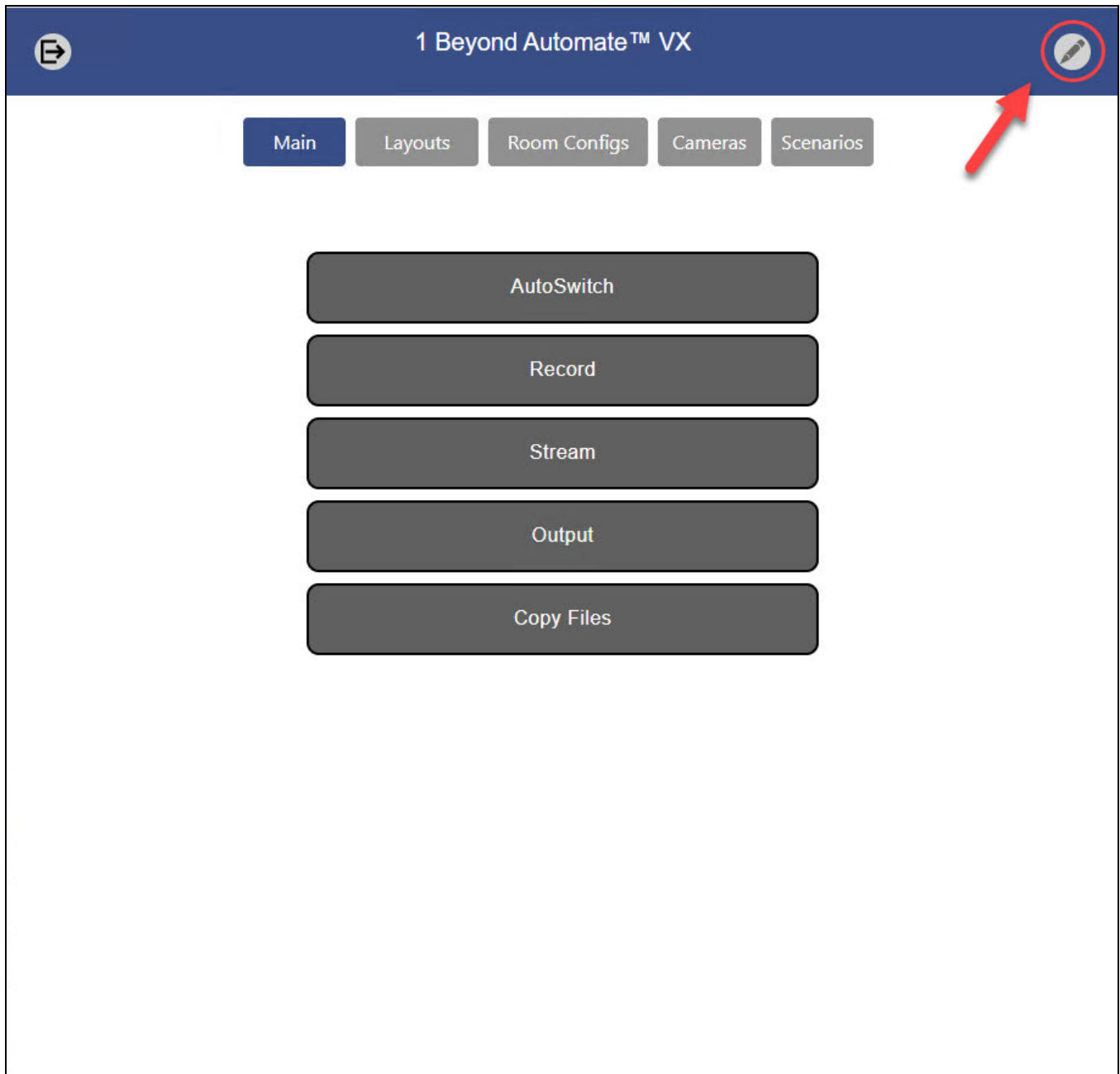

The Room Designer page is displayed.

## Room Designer Default Page

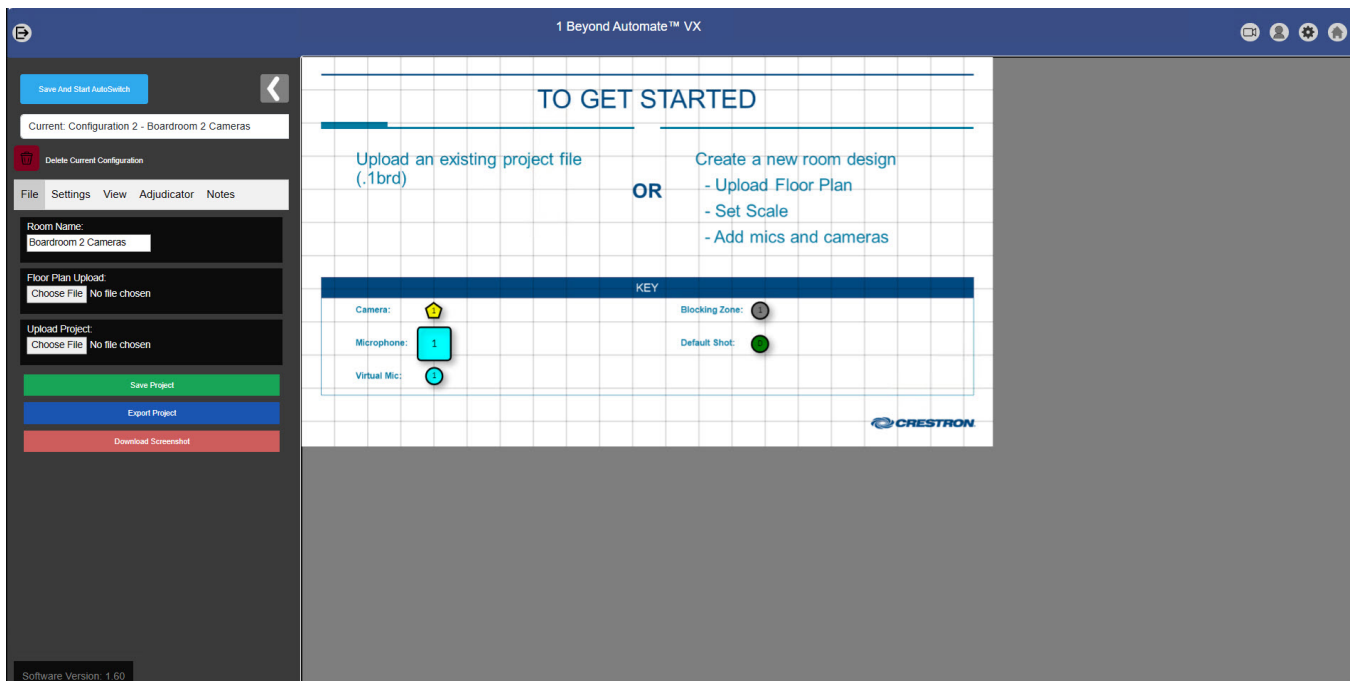

Refer to the following sections for information on how to configure a project within Room Designer.

# Floor Plan Upload

Room Designer by default comes with a demo layout tied to Configuration 1. This is only a template and should not be used as an actual room layout.

To upload a floor plan for a room design:

1. Select the **Choose File** button under the **Floor Plan Upload** banner. A file explorer window is displayed.

## Floor Plan Upload

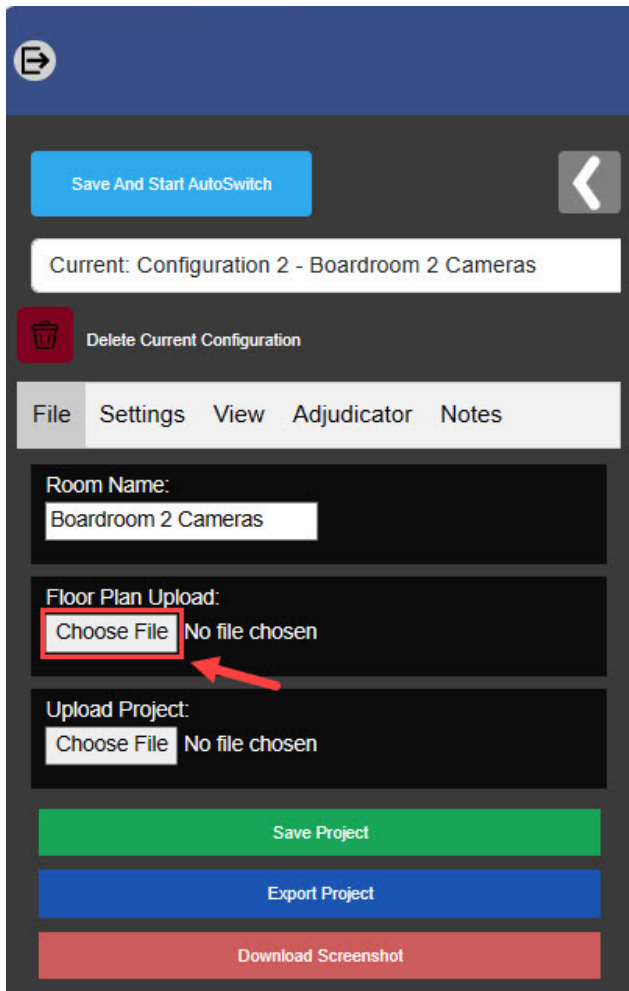

2. In the file explorer window, navigate to the desired floor plan and select it (.png and .jpeg files are supported).

The selected floor plan is displayed on the Room Designer page.

# Upload a Project

A previously created project can also be uploaded to the system. This situation occurs primarily when a project is created using the [Room Designer website](#) and needs to be uploaded to the Automate VX system.

To upload a Room Designer project into the Automate VX:

1. Ensure that the project to be uploaded is located in a file directory on the Automate VX.
2. Select the **Choose File** button under the **Upload Project** banner. A file explorer window is displayed.

## Upload Project

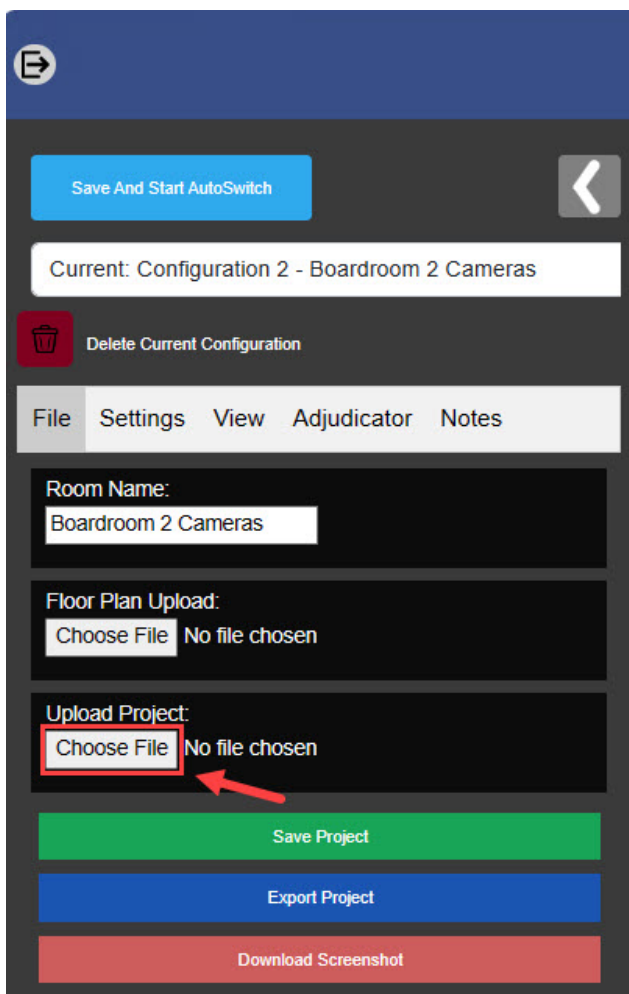

3. In the file explorer window, navigate to and select the desired Room Designer project (in a .1brd format).

#### Upload Project File Explorer Window

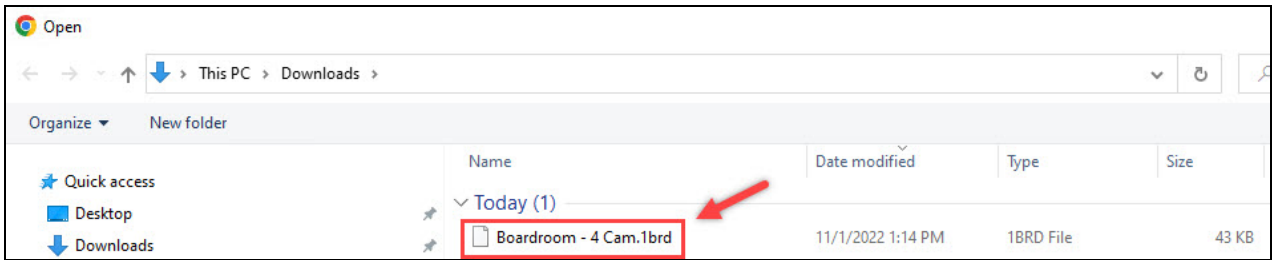

Once the project is uploaded, Room Designer updates to show the project details.

# Room Designer Settings

The following settings are provided for configuring a Room Designer project.

## Undo Command

To undo any action performed in Room Designer, press the **Ctrl + Z** buttons on the keyboard simultaneously.

## Delete Current Configuration

**NOTE:** This setting is only available on Automate VX systems.

Select the **Delete Current Configuration** button to delete the current selected configuration.

**NOTE:** Ensure that projects are saved within Room Designer and exported to a local drive before deleting configurations. If a configuration is deleted and needs to be restored, contact [Crestron True Blue Support](#).

Delete Current Configuration



Delete Current Configuration



# General Settings

Select the **Settings** tab on the left side of the Room Designer page to access the following general Room Designer settings.

## Settings Tab

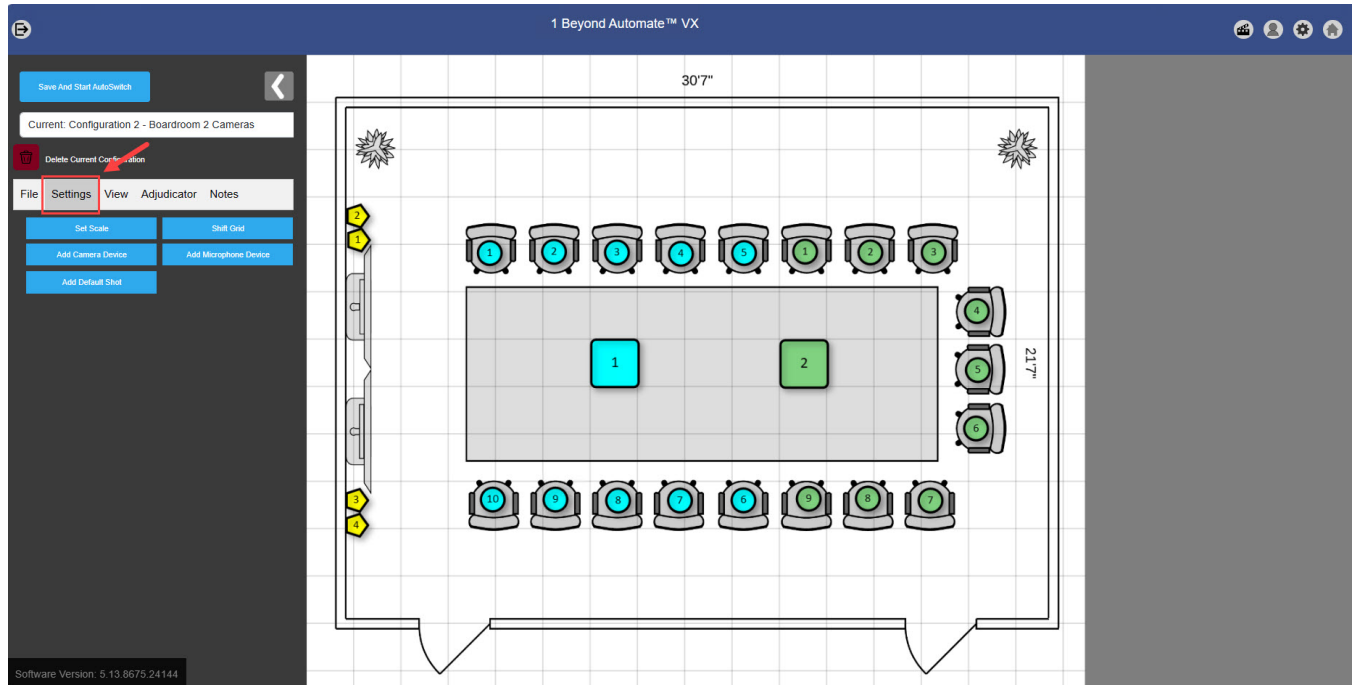

## Set Scale

Set the scale for the room to provide the Automate VX a reference to the room size.

To set the scale of the Room Designer project:

1. Select the **Set Scale** button. The mouse cursor acts as the beginning point of a measurement line.
2. Move the mouse cursor to a point in the room where the length or width of the object (for example, a conference table) is known.
3. Click once on one end of the object that is being used as a reference. There will now be a red line attached to the start point that was clicked.

**NOTE:** Holding shift while using the **Set Scale** tool will lock the red line to 90-degree increments.

4. Move the mouse cursor to the other end of the object that is being used as a reference. Ensure that the red line is straight, then click on the endpoint of the reference object.

**CAUTION:** Ensure that this process is done accurately and precisely. If the reference object was not measured correctly, then the performance of the Automate VX may suffer.

### Scaling Measurement Line

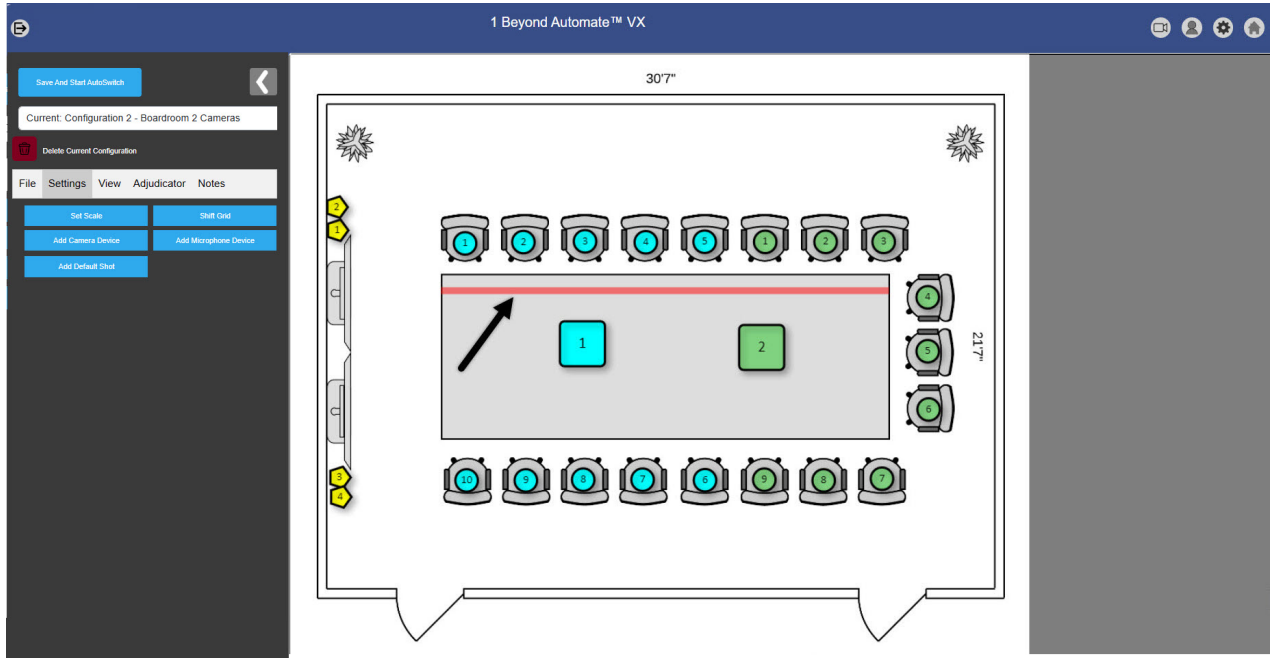

- A text field is displayed asking for the length of the red line (in either inches or millimeters, depending on if the system is set to imperial or metric). Input the length or width of the object into the field. For more information on changing the measurement units, refer to [Units on page 48](#).

### Scaling Measurement Line

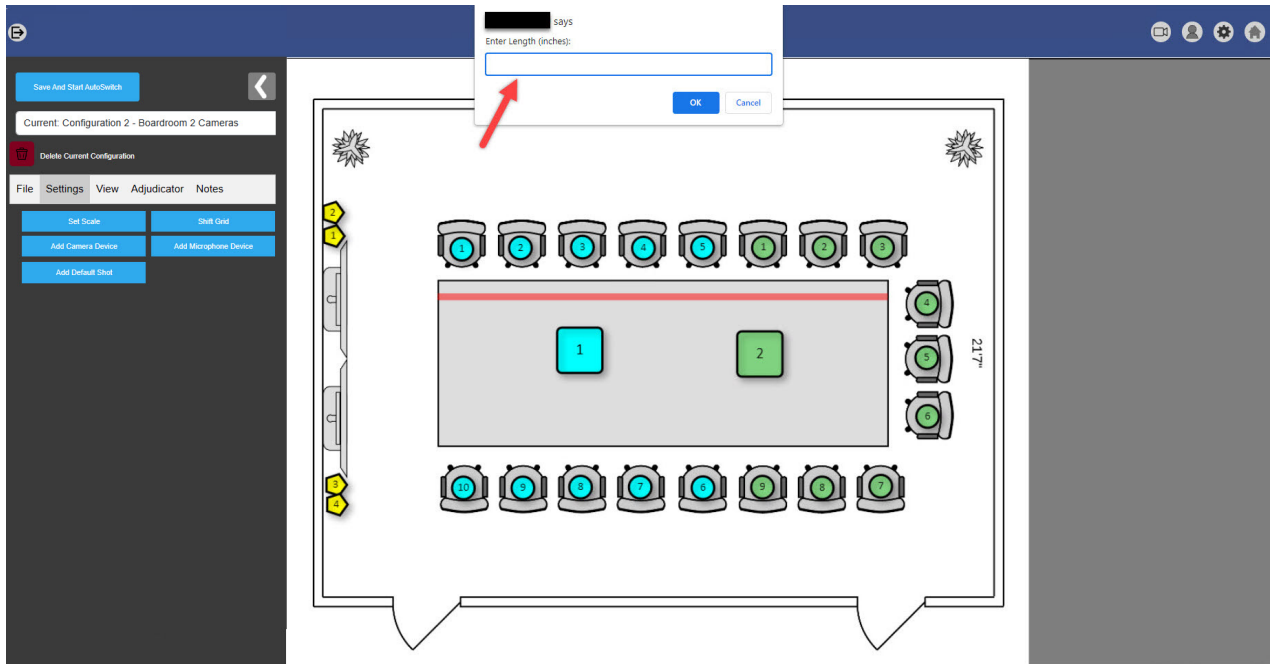

- Select **Ok** to confirm the measurement.

This will create a 2 x 2 ft (60 x 60 mm) grid that is set to the size and scale of the room to appear on the room layout. The grid will automatically appear as an overlay on the room layout when the measurement is confirmed.

**NOTE:** The grid will always be the standard 2 x 2 ft (60 x 60 mm) after setting the scale in the room layout. It may appear smaller or larger, but that is because it is scaling to the appropriate size of the room.

## Add Camera Device

Select **Add Camera Device** to add a pentagon-shaped object that designates a camera at the origin point. Place a Camera Device in each location where there is a camera within the room layout. The cameras are numbered in the order they are added. For more information, refer to [Camera Device Configuration on page 59](#)

### Camera Device

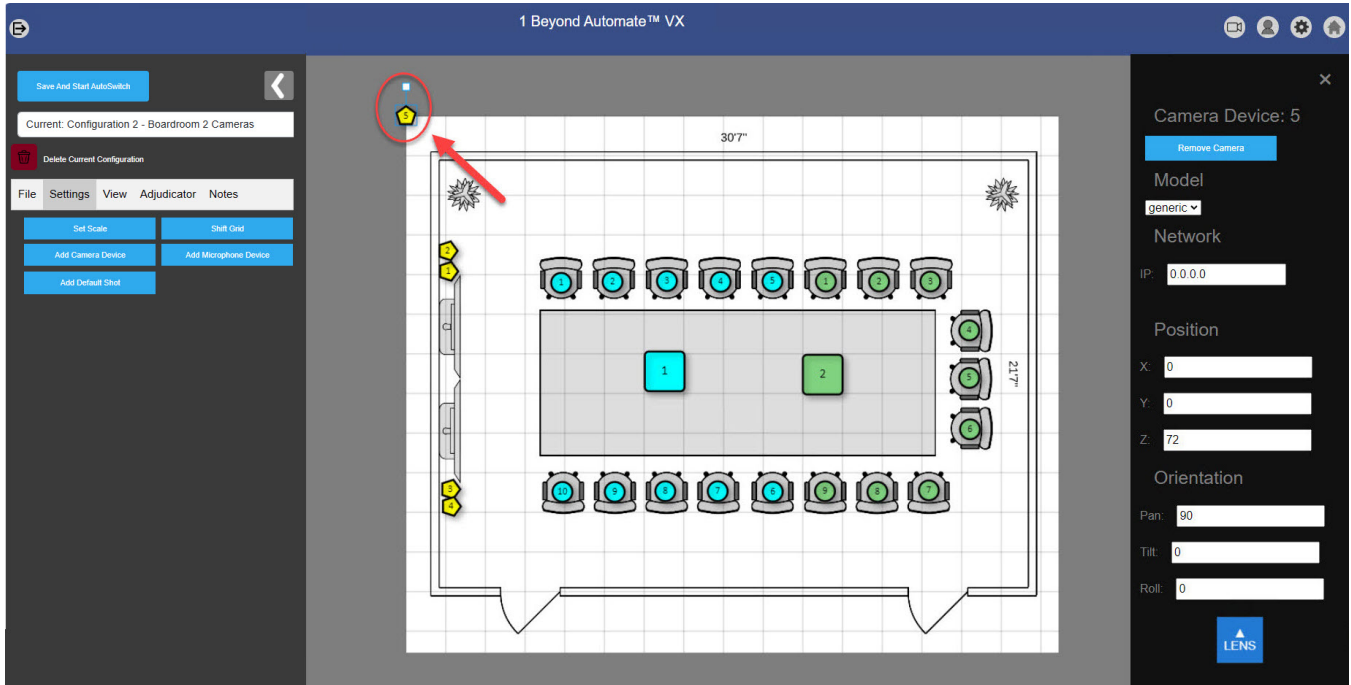

## Add Microphone Device

Select **Add Microphone Device** to add a square-shaped object that designates a microphone at the origin point. Place a Microphone Device in each location where there is a microphone within the room layout. For more information, refer to [Microphone Device Configuration on page 67](#)

If a DSP such as Biamp Tesira™, QSC Q-Sys™ Core, or Shure IntelliMix™ Room is used as a Microphone Device:

- The placement of the Microphone Device square does not matter, and it will not affect the Automate VX.
- Virtual Mics should match the positions of the individual microphones in the room. For more information, refer to [Virtual Mic and Blocking Zone Configuration on page 78](#).

### Microphone Device

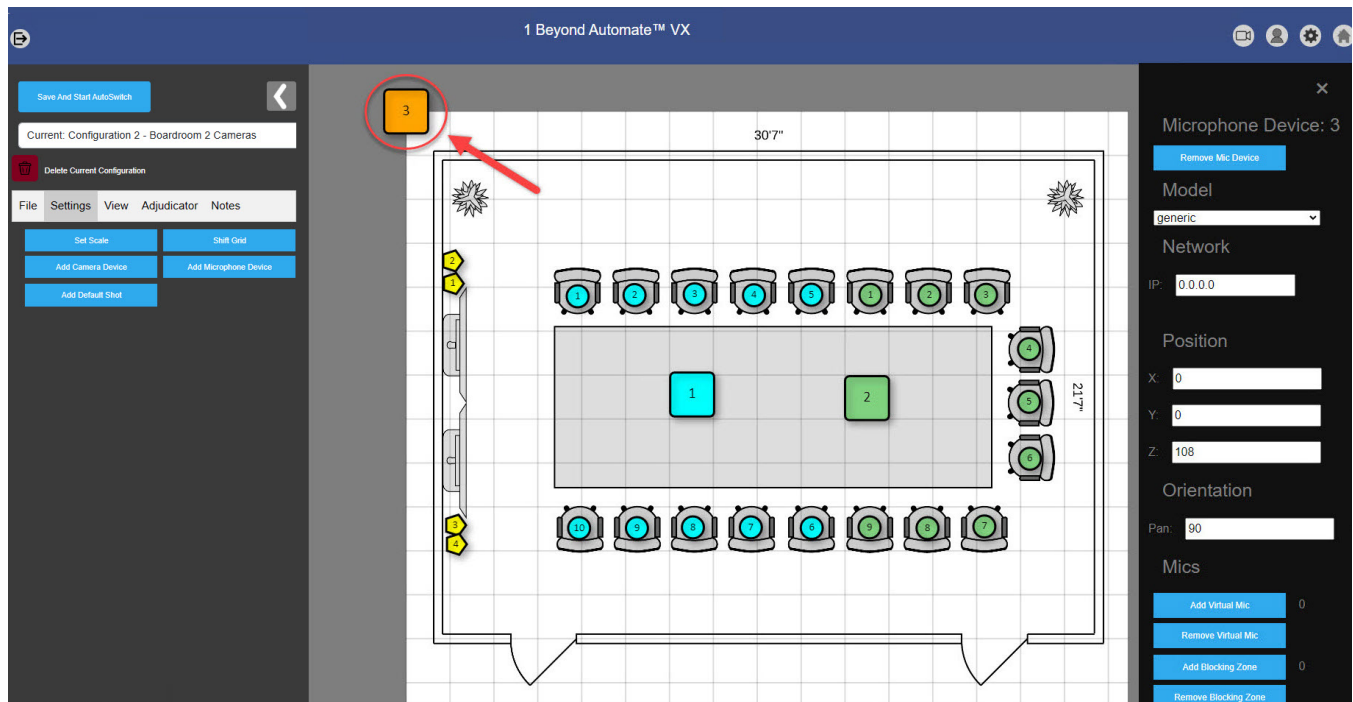

## Add Default Shot

A Default Shot is used when no audio is detected in the room for a set duration. The configuration will return from the current shot to the Default Shot after the duration elapses. For information on how to change the duration without audio before the Default Shot is called, refer to [AutoSwitch Settings on page 108](#).

Select **Add Default Shot** to add a circle-shaped object at the origin point that designates the default camera shot. The Default Shot should be placed in a neutral location, such as a wide-angle camera shot of all participants.

When the Default Shot is selected, the settings appear in the right menu and follow the same configuration parameters as Virtual Mics. For more information on the right menu and the Virtual Mic settings, refer to [Room Designer Settings on page 39](#)

### Default Shot

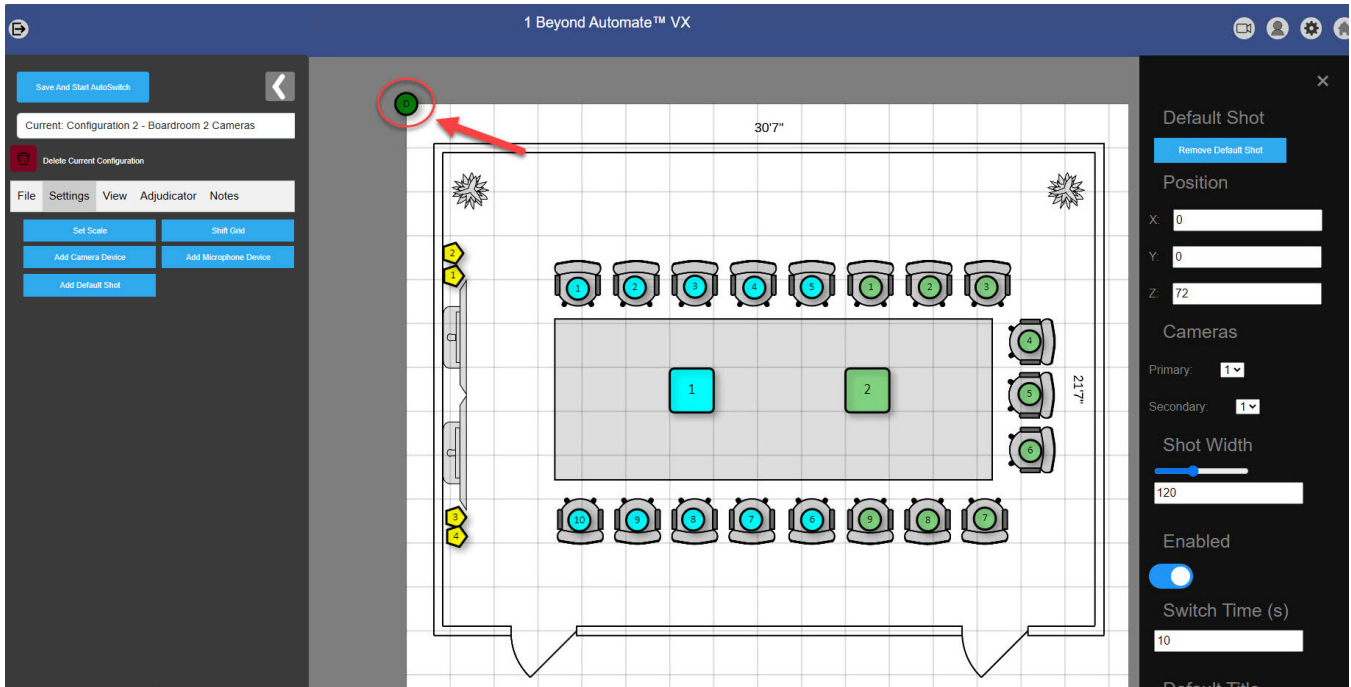

## Shift Grid

Select **Shift Grid** to move the grid overlay created by the **Set Scale** feature. Once selected, the room layout turns red. Click the grid and move it to the desired location.

### Shift Grid Overlay

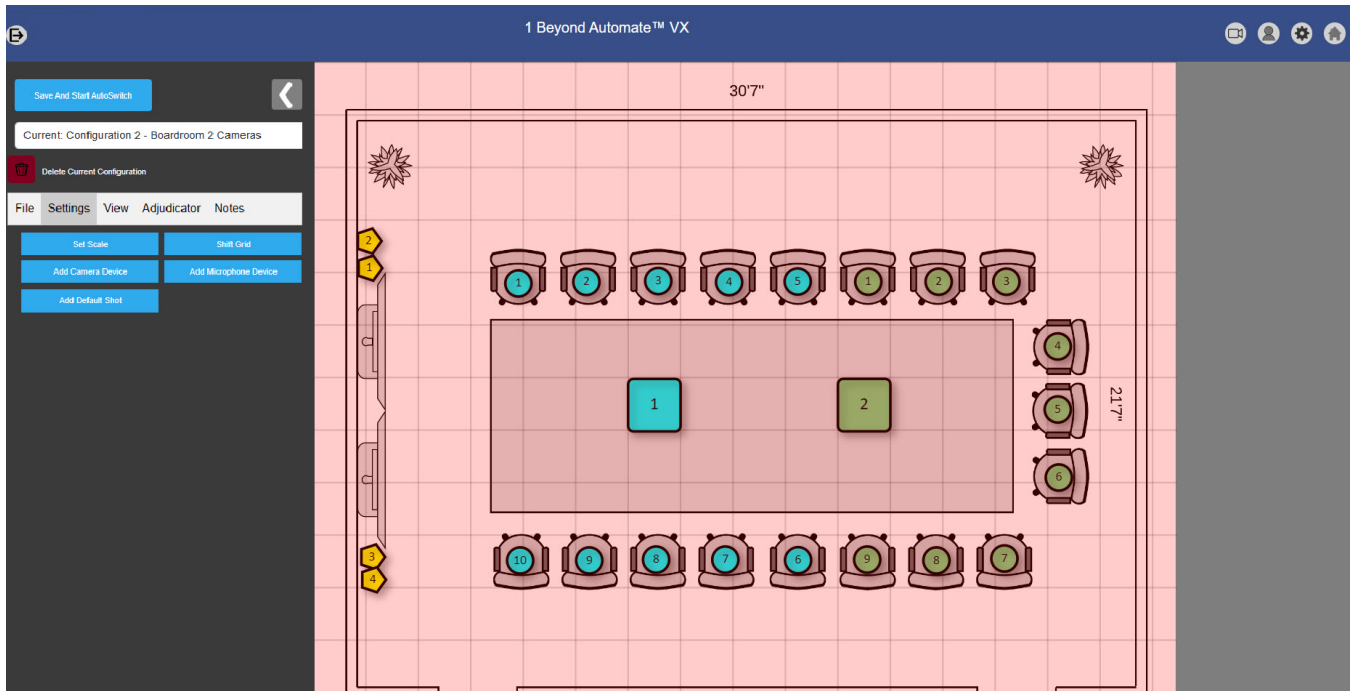

**NOTE:** Shifting the grid will not affect its scaling. The grid will retain its 2 x 2 ft (60 x 60 mm) dimensions regardless of its placement.

# View Settings

Select the **View** tab on the left side of the Room Designer page to access the following Room Designer settings.

## View Tab

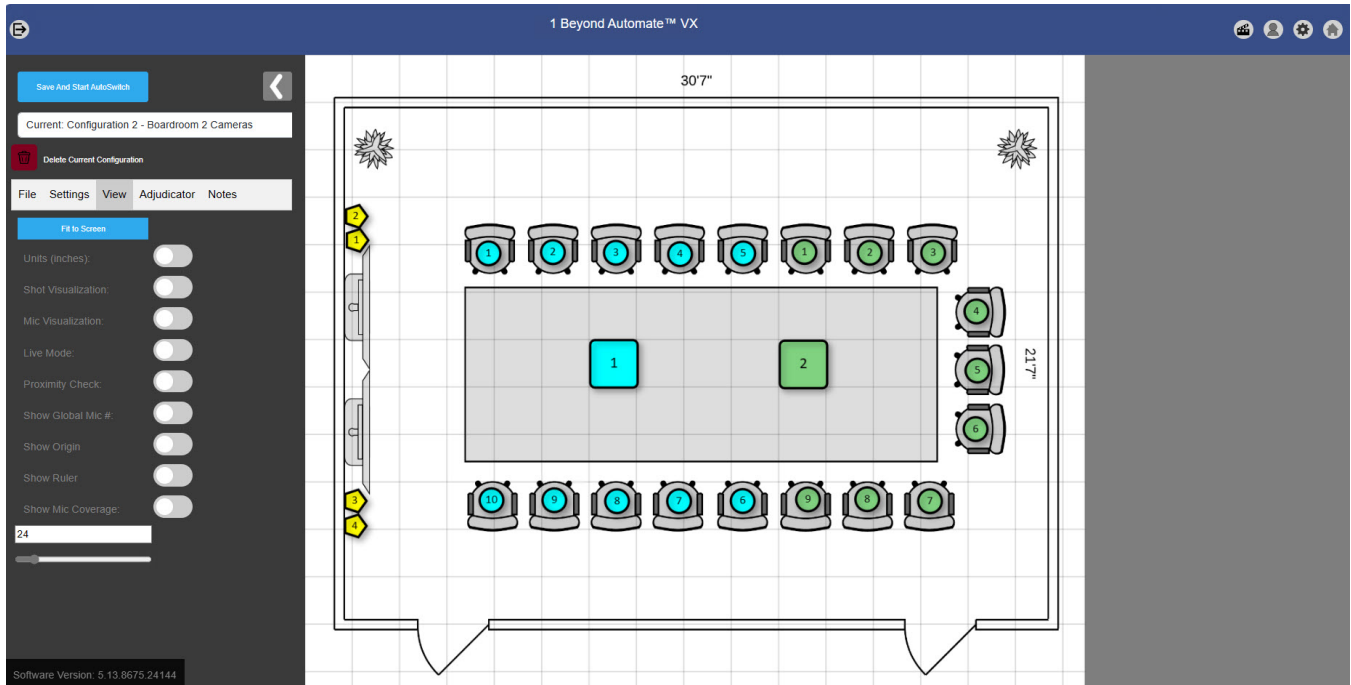



# Units

Enable **Units** to change the units used in Room Designer from imperial units (inches) to metric (millimeters). Disabling this option will revert the units from metric (millimeters) to imperial (inches). The current unit type is indicated by the parentheses next to the **Units** option.

## Units in Imperial (inches)

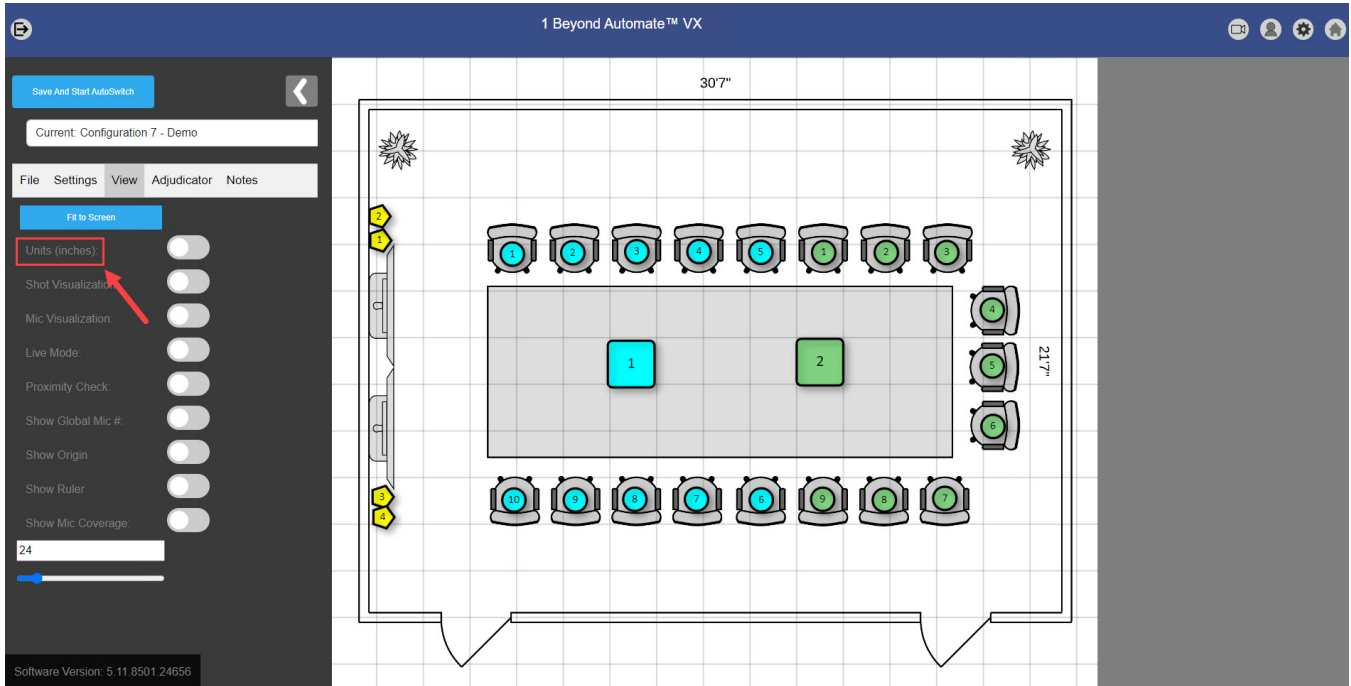

## Units in Metric (mm)

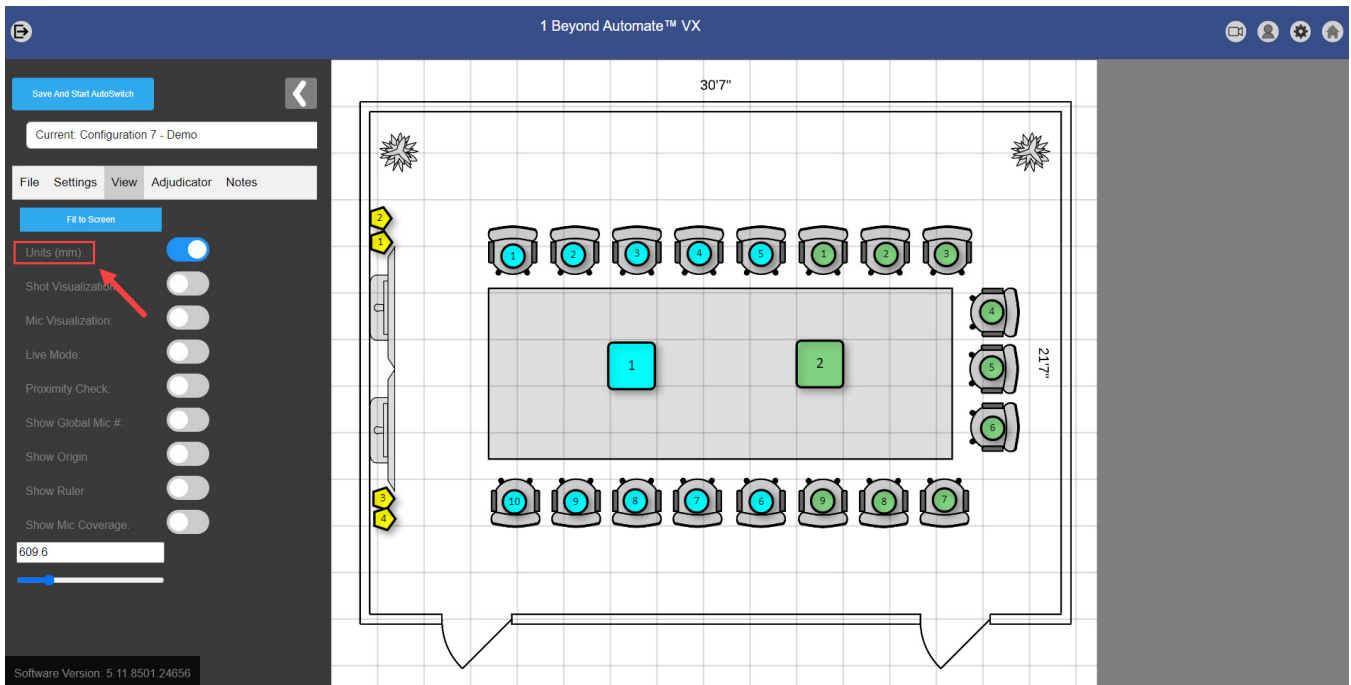

# Shot Visualization

Enable **Shot Visualization** to show which Camera Devices are aimed at a particular Virtual Mic position (or Default Shot). A cone will extend from the Camera Device to the Virtual Mic position, and the size of the cone will coincide with the Shot Width. For more information on configuring Virtual Mics with Camera Devices, refer to [Virtual Mic and Blocking Zone Configuration on page 78](#)

## Shot Visualization

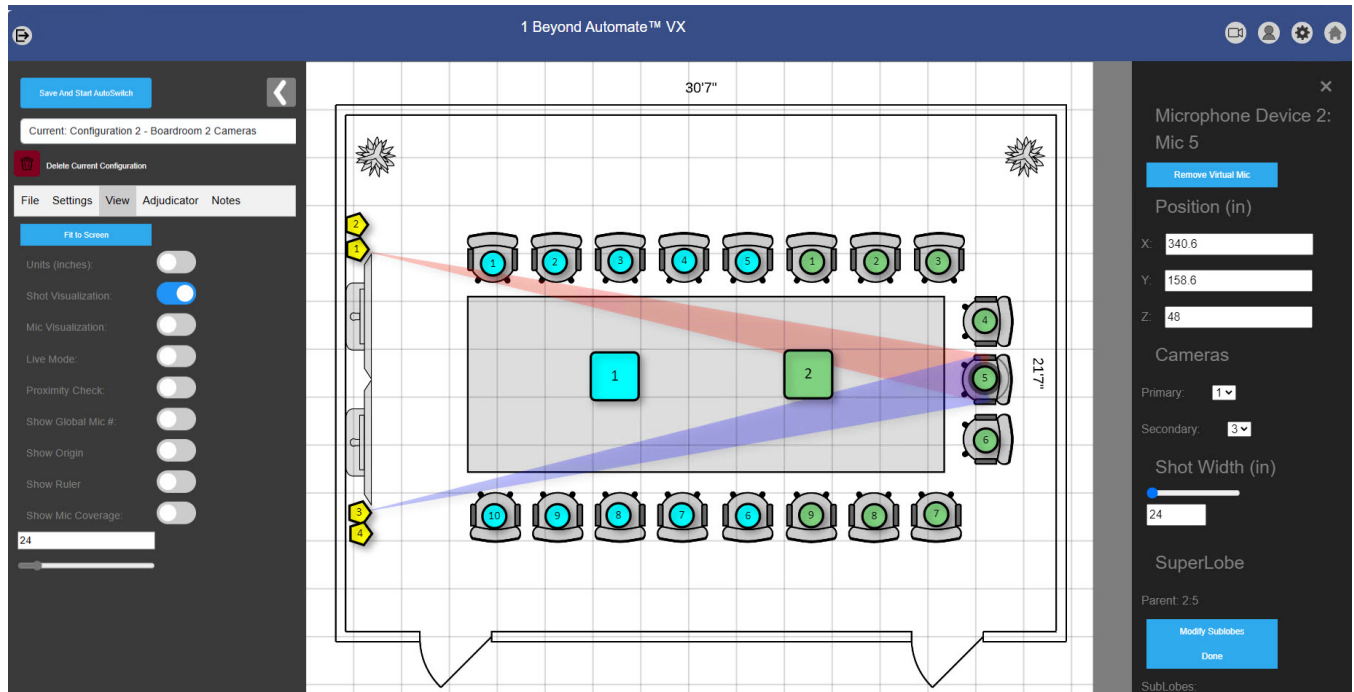

## Mic Visualization

Enable **Mic Visualization** to show which Virtual Mics are associated with the selected Microphone Device. It will be displayed with an orange line going from the Microphone Device to the Virtual Mics. This tool is useful when there is an overlap between two or more Virtual Mics.

### Mic Visualization

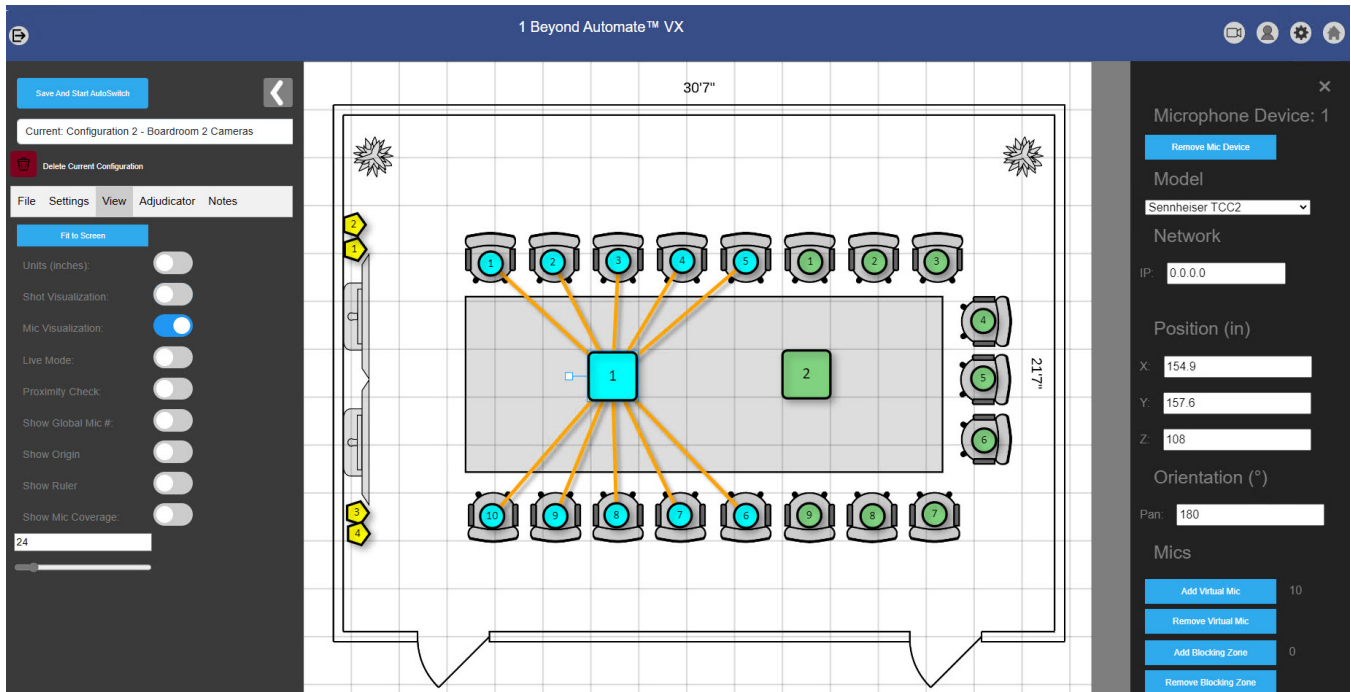

## Live Mode

**NOTE:** This setting is only available on Automate VX systems.

Enable **Live Mode** to display a grid view in Wirecast to show all live Camera Device feeds at once. When a virtual mic is selected with Live Mode enabled, the Primary and Secondary Camera Devices will point at the location of the Virtual Mic in the room automatically.

The camera shots react in real-time if the location of a Virtual Mic or Camera Device is changed. If a PTZ Override is enabled, Live Mode will show the camera shot of the PTZ Override instead of the automatically generated camera shot. For more information about Virtual Mics, refer to [Virtual Mic and Blocking Zone Configuration on page 78](#)

**NOTE: Live Mode** is useful when determining the **Virtual Mic** positions and verifying that they are in the correct position, ensuring that the camera shot is appropriately framed, and checking for obstructions in the camera shot.

# Proximity Check

Enable **Proximity Check** to show if Virtual Mics are too close to other Virtual Mics, or if they are out of range from the Microphone Device. If any of these apply, they will be indicated in the room layout with a dashed red line. If Virtual Mics do not pass the **Proximity Check**, then the Microphone Device may struggle to pinpoint that Virtual Mic location.

## Virtual Mic Proximity Check

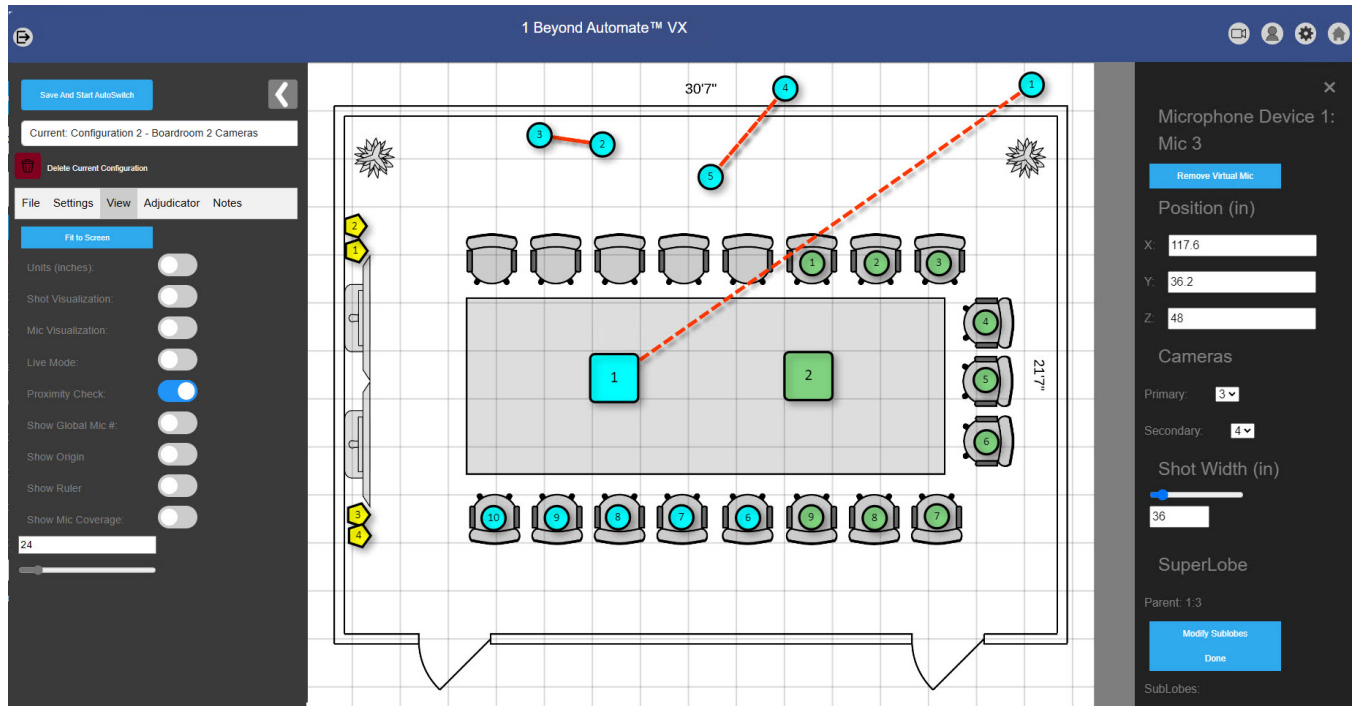

## Show Global Mic #

By default, Room Designer numbers the Virtual Mics and Blocking Zones in the system separately based on their connected Microphone Device.

### Global Mic # OFF

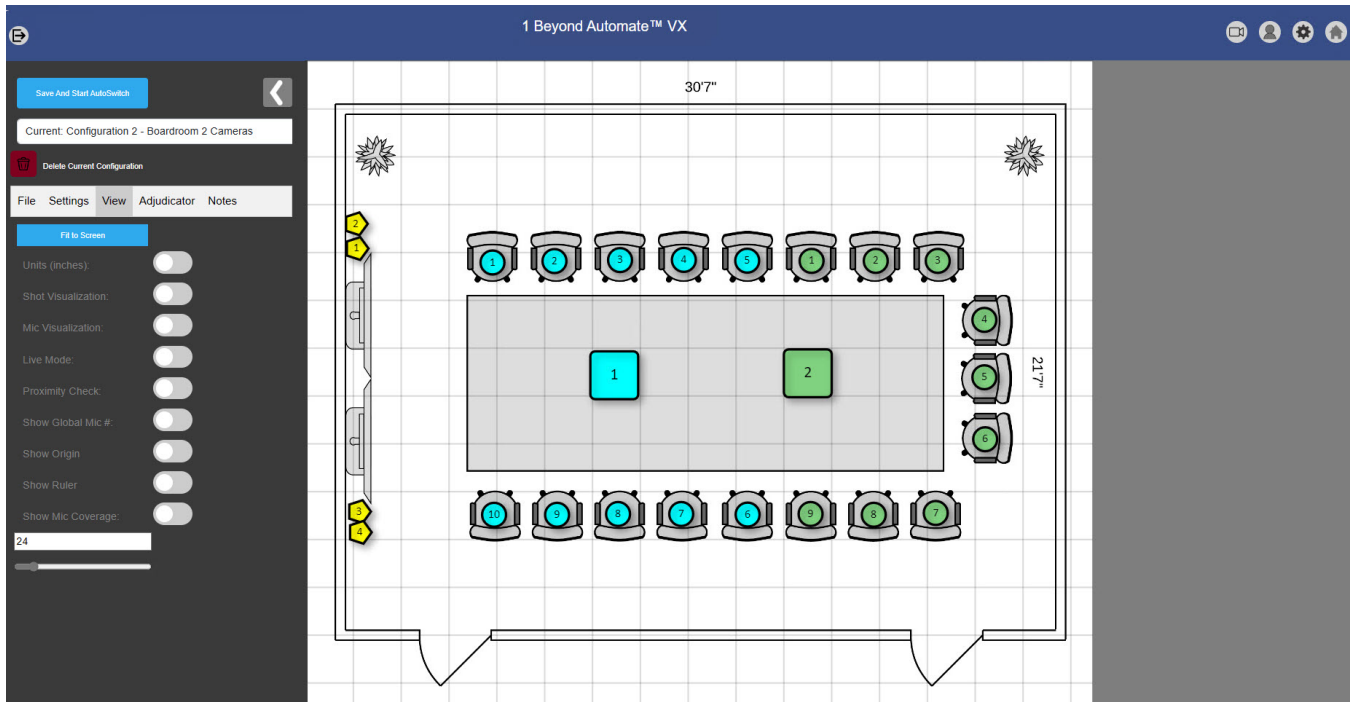

Enable **Show Global Mic #** to show the total number of virtual mics and blocking zones.

### Global Mic # ON

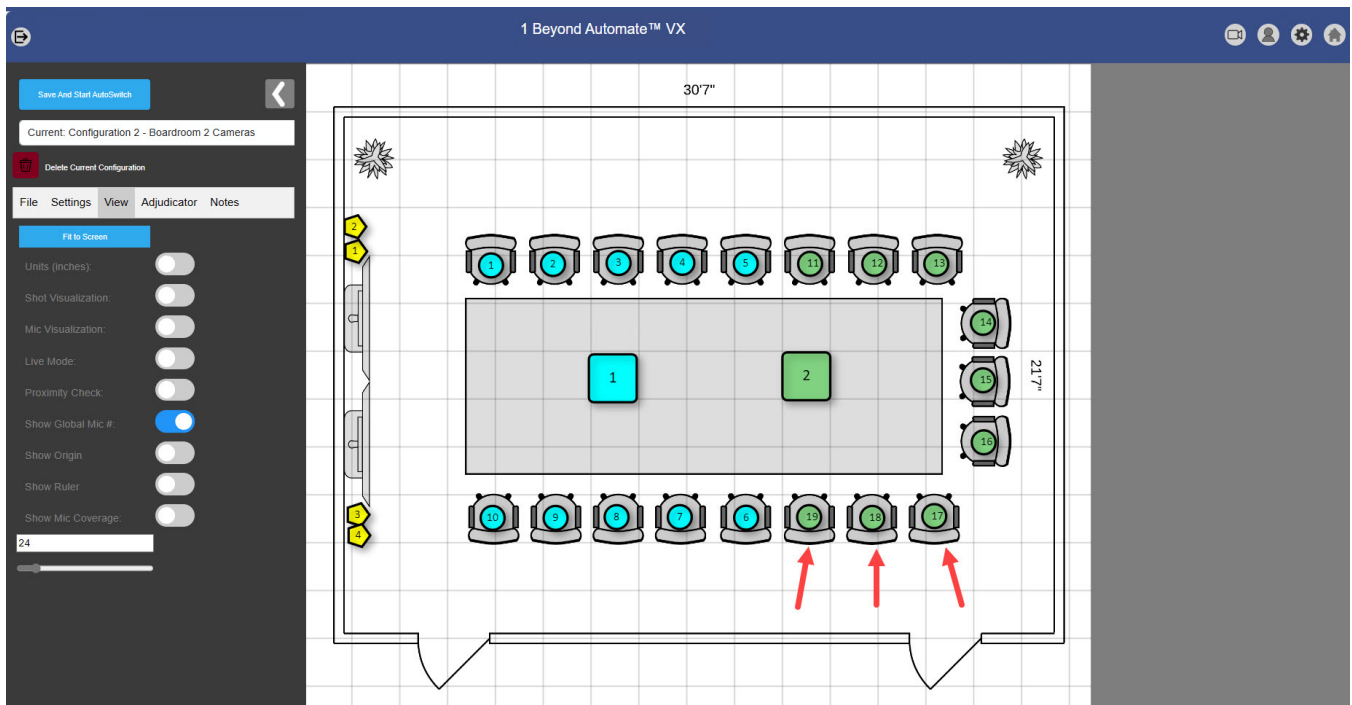

## Show Origin

Enable **Show Origin** to have the origin point visible in the room layout. The origin point is the reference point that is used for all of the coordinates used inside of Room Designer (Camera Devices, Microphone Devices, and Virtual Mic locations). The origin point is indicated by the red circle with a dot in the room layout.

### Origin Point

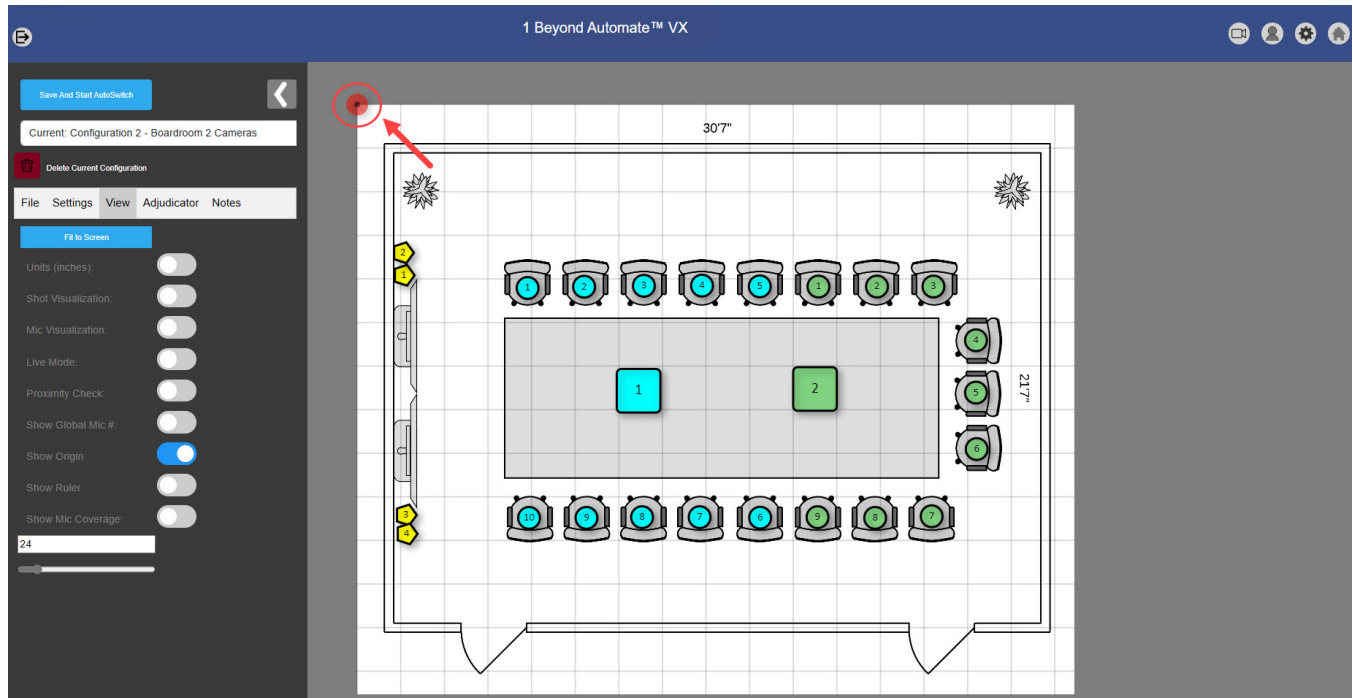

To move the origin point, click and hold the left mouse button on the origin point and drag the cursor. Use the origin point as a measurement tool to determine distances inside the room layout. Wherever the origin point is placed, it becomes the central location (0,0) for coordinates. The system automatically changes the coordinates of all entities in the configuration to reflect their locations relative to the new origin point.

## Show Ruler

Enable **Show Ruler** to display a ruler on the top and left of the room layout. The ruler will use the corresponding unit from the **Units** option (inches or millimeters). The 0,0 position on the ruler is determined by the origin point.

### Ruler Overlay

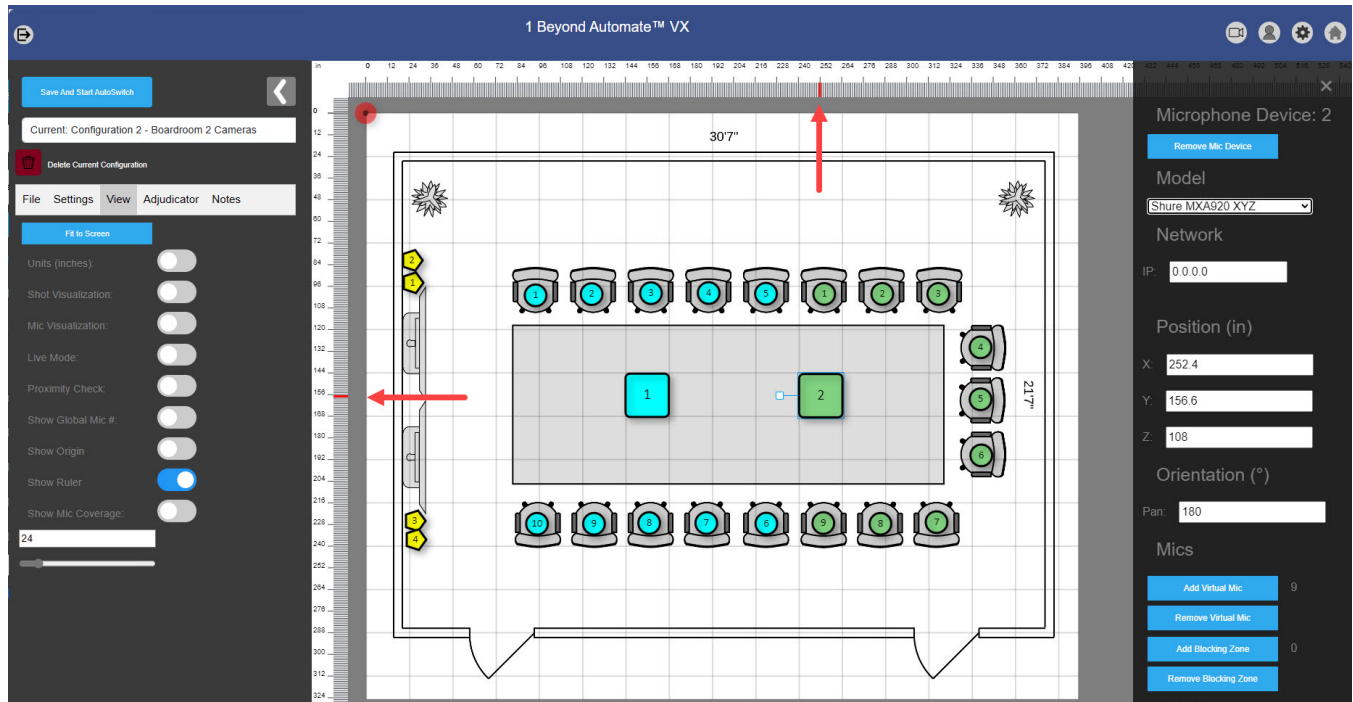

The ruler displays red lines as the X and Y coordinates indicating where the cursor is in the room layout. Use the red lines as a positional reference when moving Camera Devices, Microphone Devices, and Virtual Mic positions within the room layout.

## Show Mic Coverage

Enable **Show Mic Coverage** to show the circular range of Virtual Mic positions. This range indicates the area where the Microphone Device will switch the camera feed to the Virtual Mic's location when audio is detected.

**NOTE:** The **Show Mic Coverage** feature is only applicable to the Shure MXA920 XYZ, Sennheiser TCC2, Sennheiser TCCM, Audio Technica® ATND1061, and Yamaha ADECIA™ microphones.

### Virtual Mic Coverage

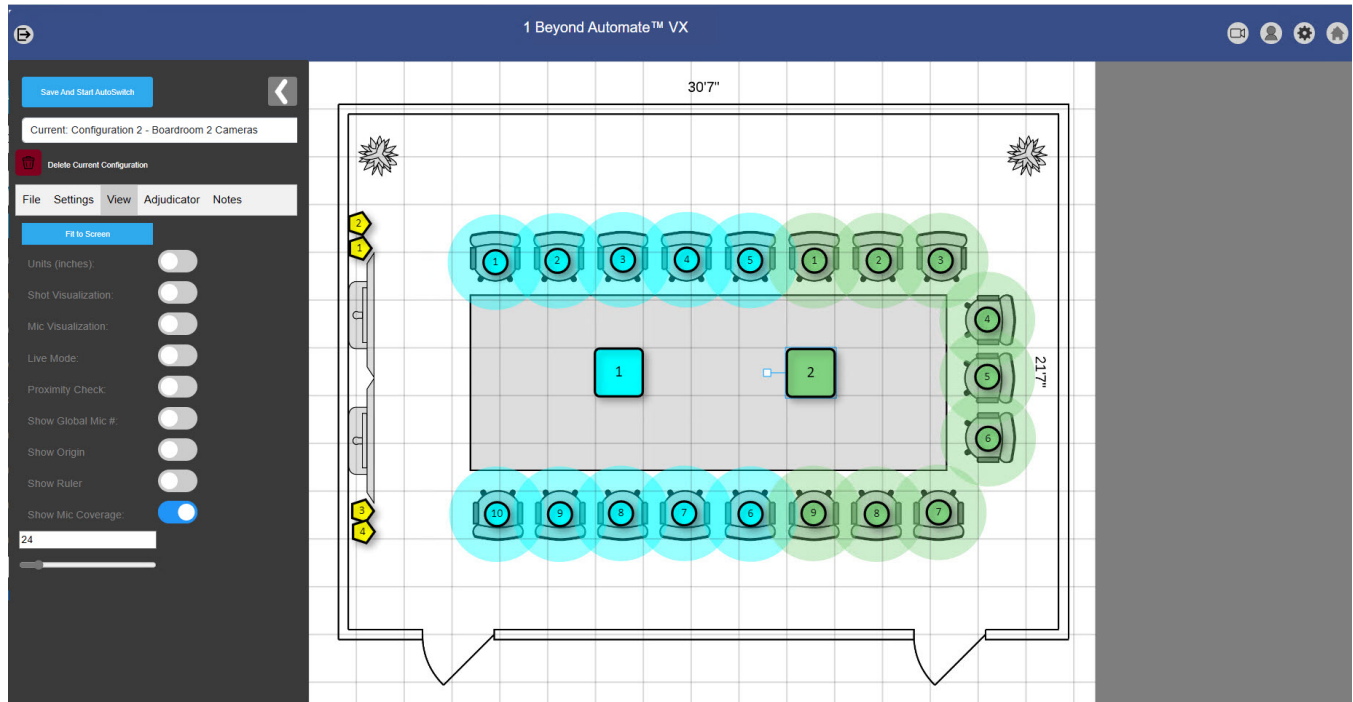



Use the text field to input a Virtual Mic radius or use the slider to adjust the radius. Change the Virtual Mic radius to fine-tune Virtual Mic locations so that there is no overlap between positions.

### Virtual Mic Coverage Radius

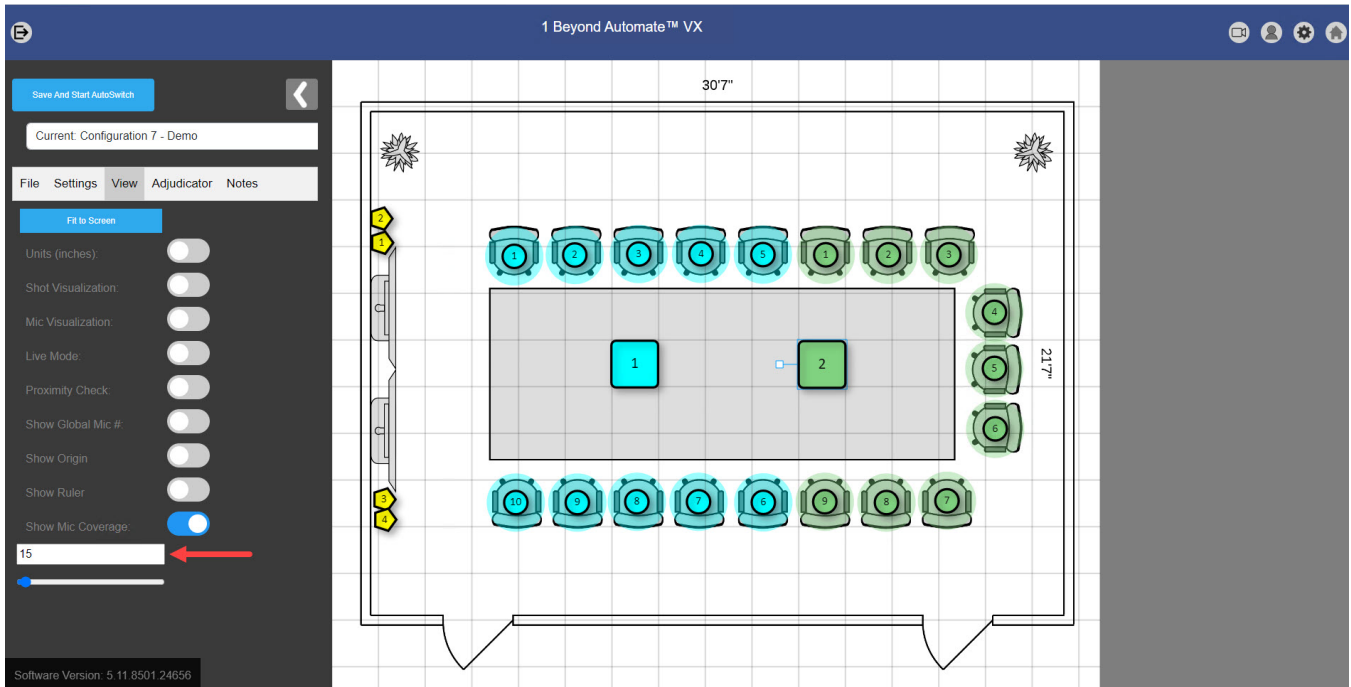

# Adjudicator Settings

Select the **Adjudicator** tab on the left-hand side of the Room Designer page to access the following room adjudicator settings.

## Adjudicator Tab

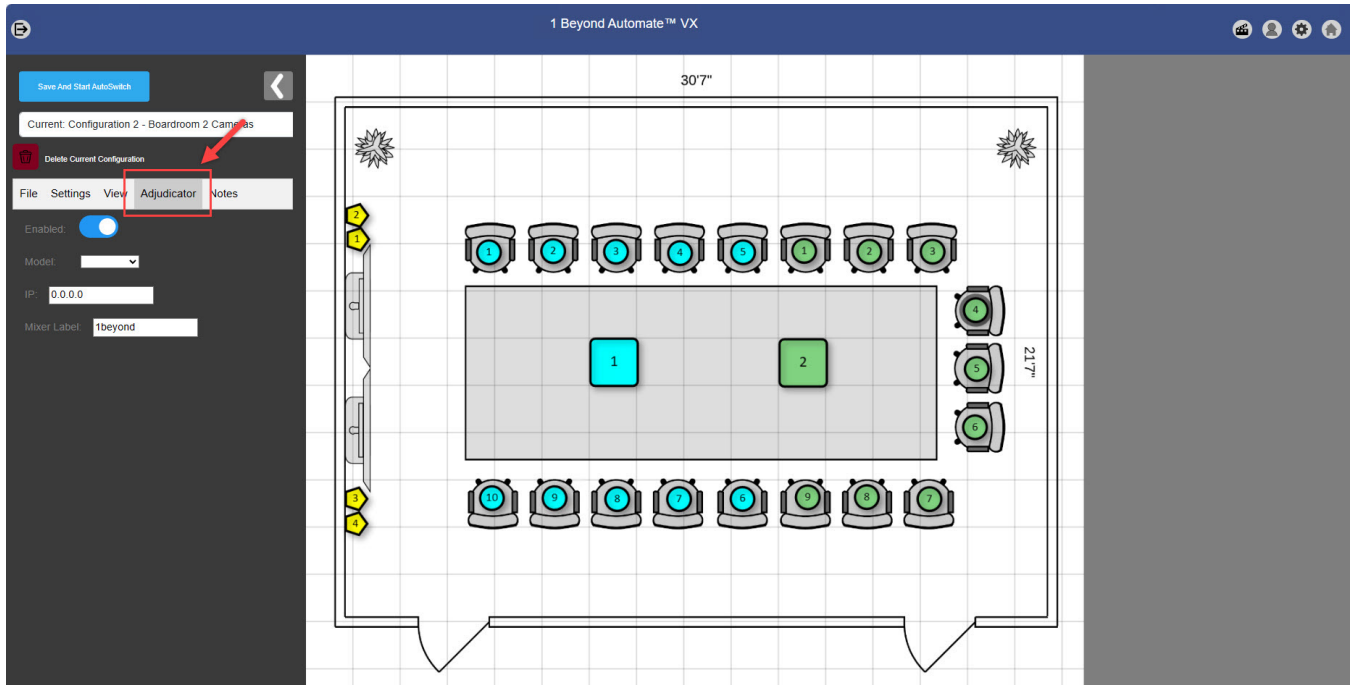

- To enable the adjudicator, turn on the **Enabled** toggle. This should be enabled when there is a DSP involved with the room configuration. When the adjudicator setting is enabled, the other settings beneath it become available. For more information about adjudicators, refer to [Configuring Adjudicators on page 90](#)
- Select the DSP model used by opening the drop-down menu next to the **Model** title. The following DSPs are compatible with Automate VX:
  - Shure Intellimix™ Room (**IMX-Rm**)
  - Shure P300 (**P300**)
  - QSC Q-SYS™ Core (**Q-SYS**)
  - Shure SCM-820 (**SCM-820**)
  - Biamp Tesira™ (**TESIRA**)
- Enter the IP address of the DSP into the field to the right of the **IP** title.
- Enter the name that will appear on the DSP that indicates the Automate VX into the **Mixer Label** field.

# Notes Page

Select the **Notes** tab on the left-hand side of the Room Designer page to access the notes page. Information or any notes about the current room configuration can be placed here and will be saved for future use.

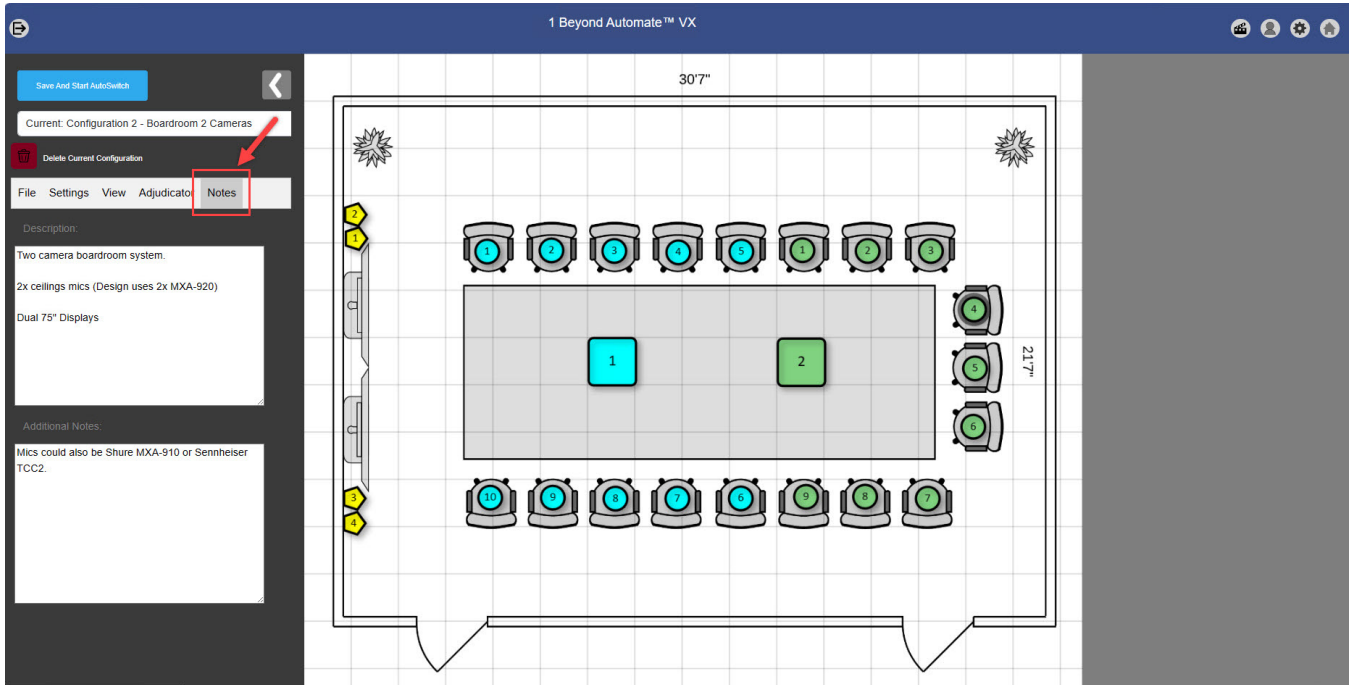

# Camera Device Configuration

**Camera Devices** are the camera outputs that the Automate VX uses to display the camera feed. Camera Devices are indicated in Room Designer as pentagon-shaped nodes. For more information about adding cameras to a room layout, refer to [Add Camera Device on page 43](#).

Once the Camera Devices are placed in the room layout, select a Camera Device to open the Camera Device Settings. This panel will appear on the right side of the screen.

## Camera Device Settings

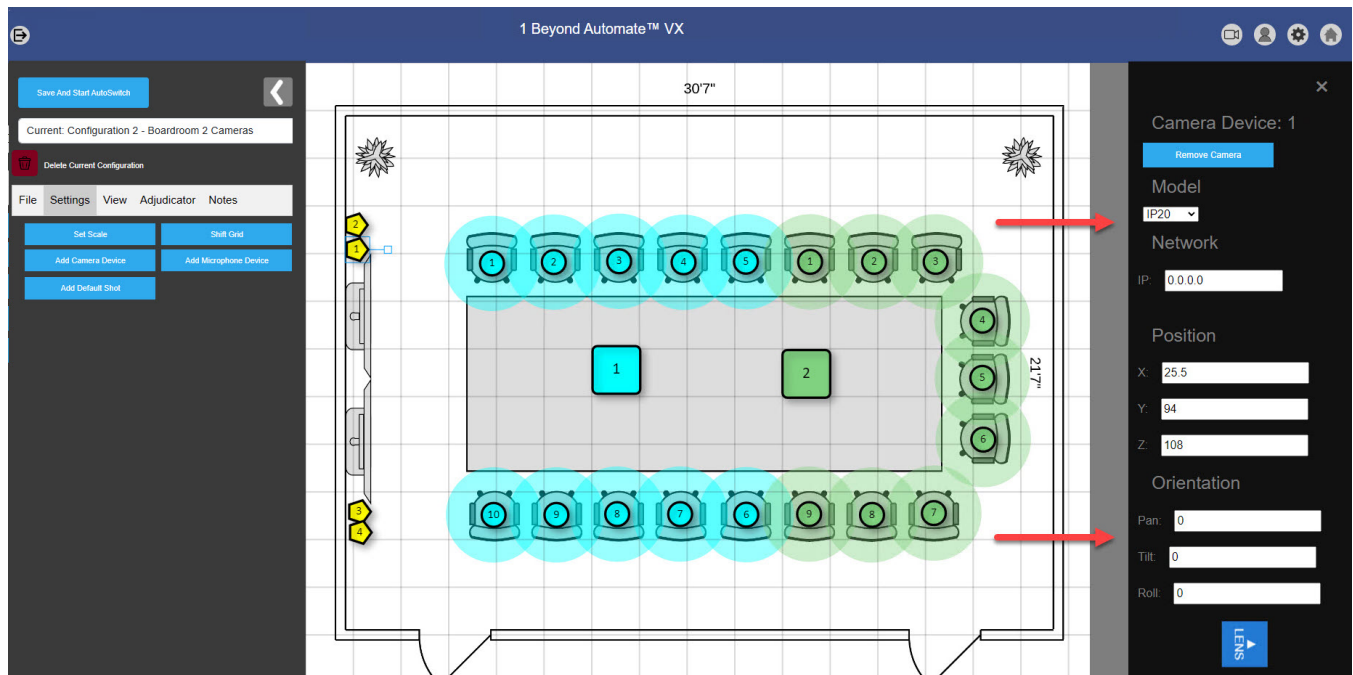

The following Camera Device settings are available.

## Remove Camera

Select the **Remove Camera** button to remove the selected Camera Device from the current configuration. This removes all settings associated with the Camera Device from the configuration.

### Remove Camera Button

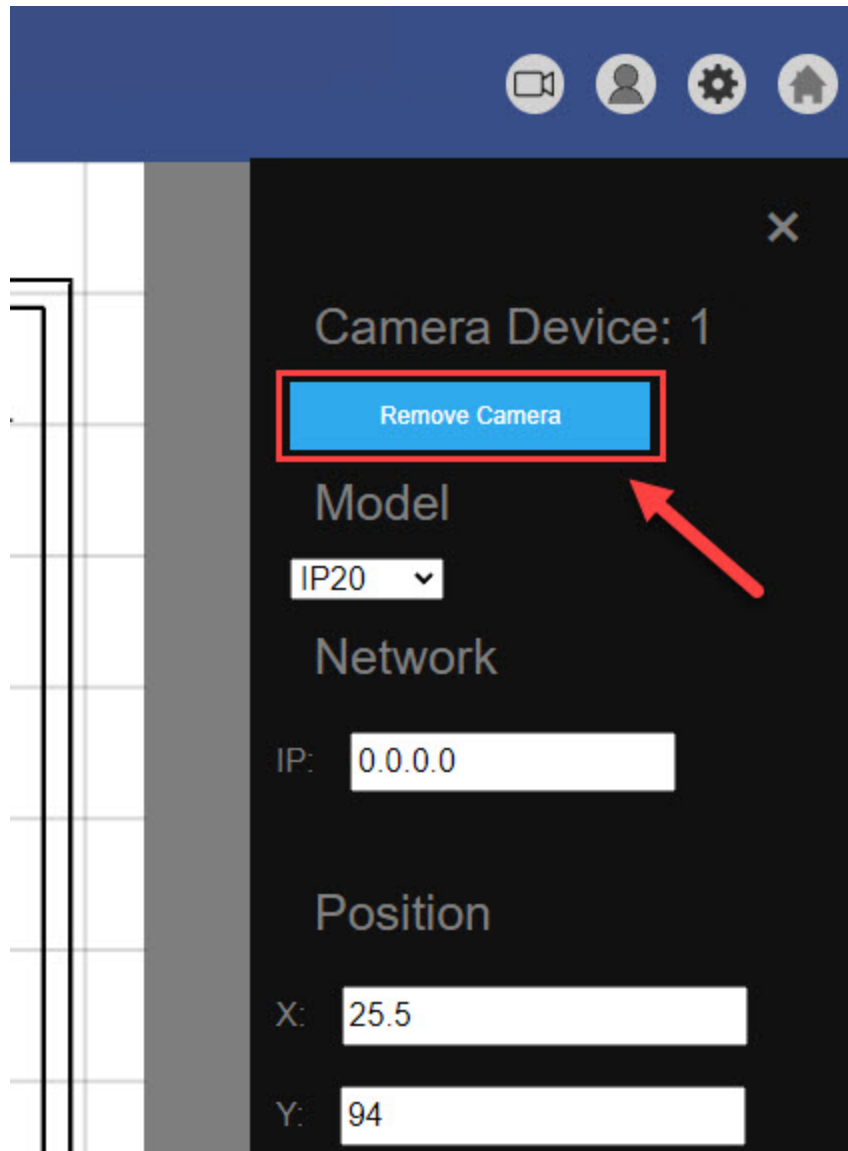

## Model

Select the drop-down menu under the **Model** title to select the camera model for the respective Camera Device. This should match the same model that was used in the physical room.

### Camera Device Model Menu

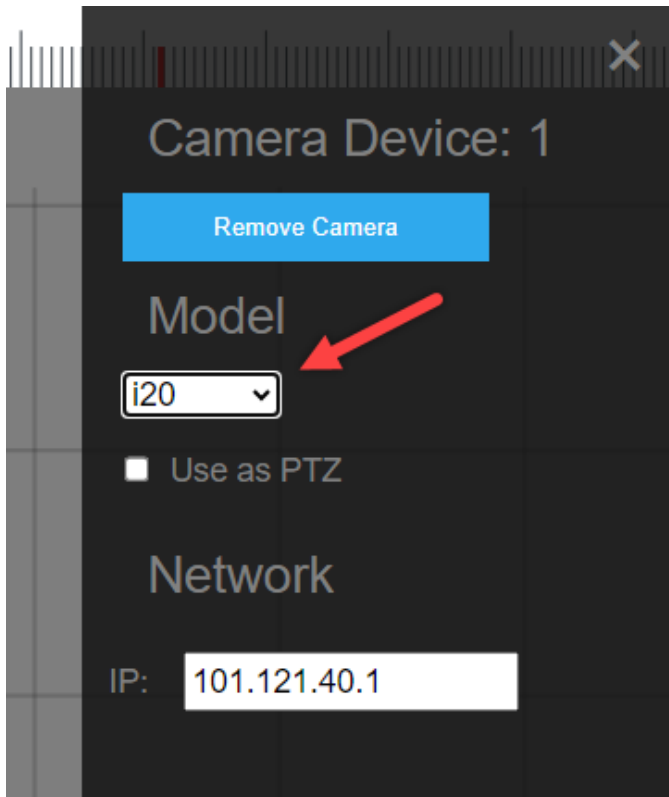

The following camera models are available.

- **AT:** Select this when the camera model being used is a 1 Beyond AutoTracker 3 camera. For more information about 1 Beyond AutoTracker 3 cameras, refer to the [1 Beyond AutoTracker™ 3 Product Manual](#).

Refer to the list below for additional information about AutoTracker 3 cameras in Room Designer:

- The PTZ controls (Position and Orientation controls) on these cameras do not need to be adjusted, as the AutoTracker 3 does the tracking internally.
- If custom PTZ controls are desired, then select the **Use as PTZ** check box.
- AutoTracker 3 cameras are shown in Room Designer as an orange pentagon.

**NOTE:** When updating the firmware to the current version from versions prior to 6.1, previously configured AutoTracker 3 cameras will not work when set to IP20. Set the AutoTracker 3 camera to **AT** and select the **Use as PTZ** check box to use an AutoTracker 3 with custom PTZ controls.

- **generic:** Select this when the camera model being used is not a listed camera. The generic cameras do not have access to PTZ controls (Position and Orientation controls).
- **i12:** Select this when the camera model being used is a Crestron 1 Beyond i12 camera. For more information about Crestron 1 Beyond i12 cameras, refer to the [Crestron 1 Beyond Camera Product Manual](#).

Refer to the list below for additional information about i12 cameras in Room Designer:

- The PTZ controls (Position and Orientation controls) on these cameras do not need to be adjusted, as the i12 does the tracking internally.
  - If custom PTZ controls are desired, then select the **Use as PTZ** check box.
  - i12 cameras are shown in Room Designer as an orange pentagon.
- **i20:** Select this when the camera model being used is a Crestron 1 Beyond i20 camera. For more information about Crestron 1 Beyond i20 cameras, refer to the [Crestron 1 Beyond Camera Product Manual](#).

Refer to the list below for additional information about i20 cameras in Room Designer:

- The PTZ controls (Position and Orientation controls) on these cameras do not need to be adjusted, as the i20 does the tracking internally.
  - If custom PTZ controls are desired, then select the **Use as PTZ** check box.
  - i20 cameras are shown in Room Designer as an orange pentagon.
- **IP12:** Select this when the camera model being used is a 1 Beyond PTZ-12 camera. These cameras have full access to the Automate VX's camera features, including PTZ controls. For more information about 1 Beyond PTZ-12 cameras, refer to the [1 Beyond PTZ 12 Series Product Manual](#).
  - **IP20:** Select this when the camera model being used is a 1 Beyond PTZ-20 camera. These cameras have full access to the Automate VX's camera features, including PTZ controls. For more information about 1 Beyond PTZ-20 cameras, refer to the [1 Beyond PTZ 20 Series Product Manual](#).
  - **p12:** Select this when the camera model being used is a Crestron 1 Beyond p12 camera. These cameras have full access to the Automate VX's camera features, including PTZ controls. For more information about Crestron 1 Beyond p12 cameras, refer to the [Crestron 1 Beyond Camera Product Manual](#).
  - **p20:** Select this when the camera model being used is a Crestron 1 Beyond p20 camera. These cameras have full access to the Automate VX's camera features, including PTZ controls. For more information about Crestron 1 Beyond p20 cameras, refer to the [Crestron 1 Beyond Camera Product Manual](#).

# Network

Enter the IP address of the camera that is being used as the Camera Device in the **IP** text field. Crestron 1 Beyond cameras IP addresses can be obtained and changed in the Crestron 1 Beyond Camera Manager. For more information about the Crestron 1 Beyond Camera Manager, refer to the [documentation for your Crestron 1 Beyond camera model](#).

**NOTE:** When adding Camera Devices, ensure that the camera numbers in Room Designer match the IP addresses and corresponding Wirecast shots for each camera. For more information about Wirecast, refer to [Wirecast Configuration on page 132](#).

## Camera Device Network Setting

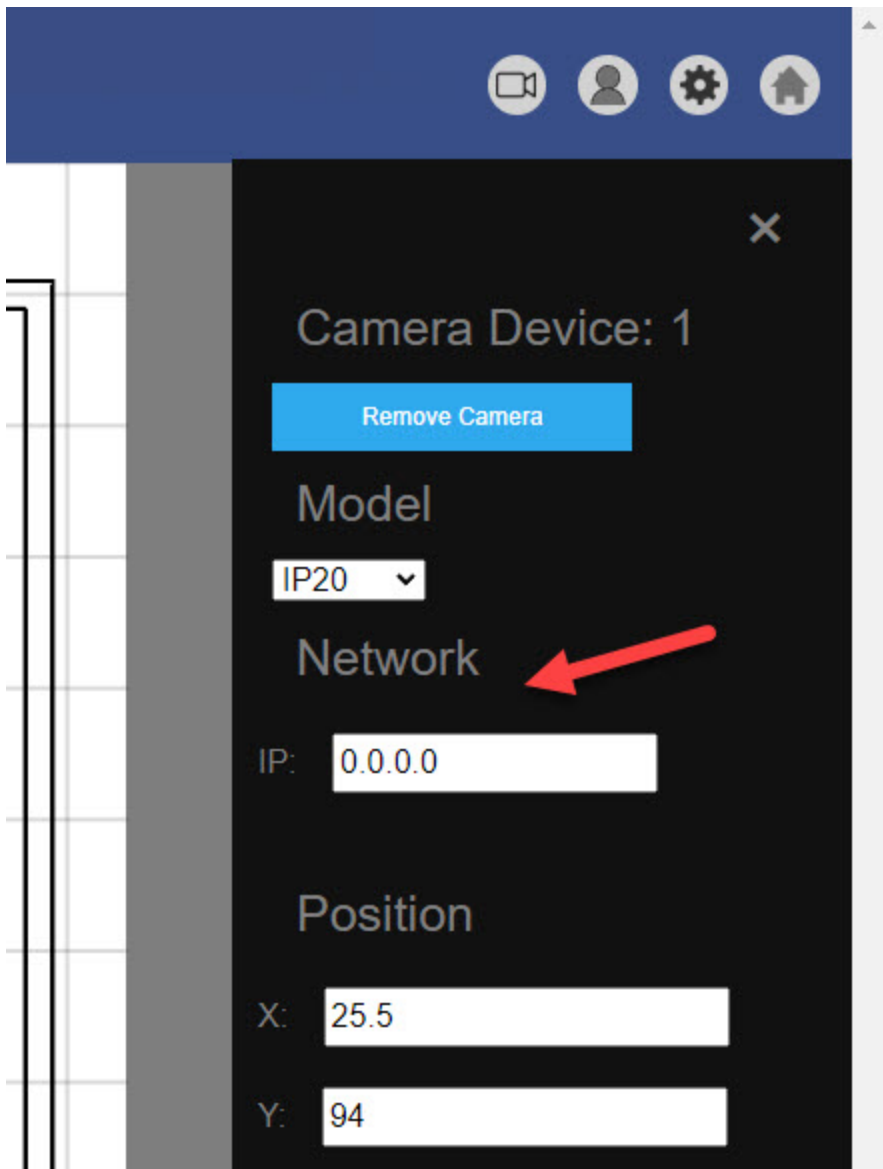



# Position

The **X**, **Y**, and **Z** fields are the coordinates of the Camera Device in the room layout. Enter the coordinates of the Camera Device into their respective fields, or drag the Camera Device and place it into the correct location. The units used in the text fields are either in inches or millimeters, depending on the unit selected in the **View** tab. For more information about changing the units, refer to [Camera Device Configuration on page 59](#)

**NOTE:** The X, Y, and Z coordinates of the Camera Device are measured relative to the set Origin Point. For more information about the Origin Point, refer to [Show Origin on page 53](#)

## Camera Device Position Setting

The screenshot displays the 'Camera Device Position Setting' interface. On the left, a grid shows camera icons numbered 4, 5, and 6, with a vertical dimension line labeled '21.7\". On the right, a dark panel contains the following settings:

- Model:** IP20 (dropdown menu)
- Network:** IP: 0.0.0.0 (text field)
- Position:** X: 25.5, Y: 94, Z: 108 (text fields). A red arrow points to the X field.
- Orientation:** Pan: 0, Tilt: 0, Roll: 0 (text fields)

# Orientation

The **Pan**, **Tilt**, and **Roll** text fields indicate the direction the Camera Device's lens is facing when it is in the default (resting) state. The direction that the camera lens is facing is indicated by the blue **LENS** box. **LENS** is the bird-eye view of the top of the camera, and the orientation of the blue box should match the way the camera is set up in the physical room.

Use the **Pan**, **Tilt**, and **Roll** text fields to change the direction of the Camera Device.

## Camera Device Orientation Setting

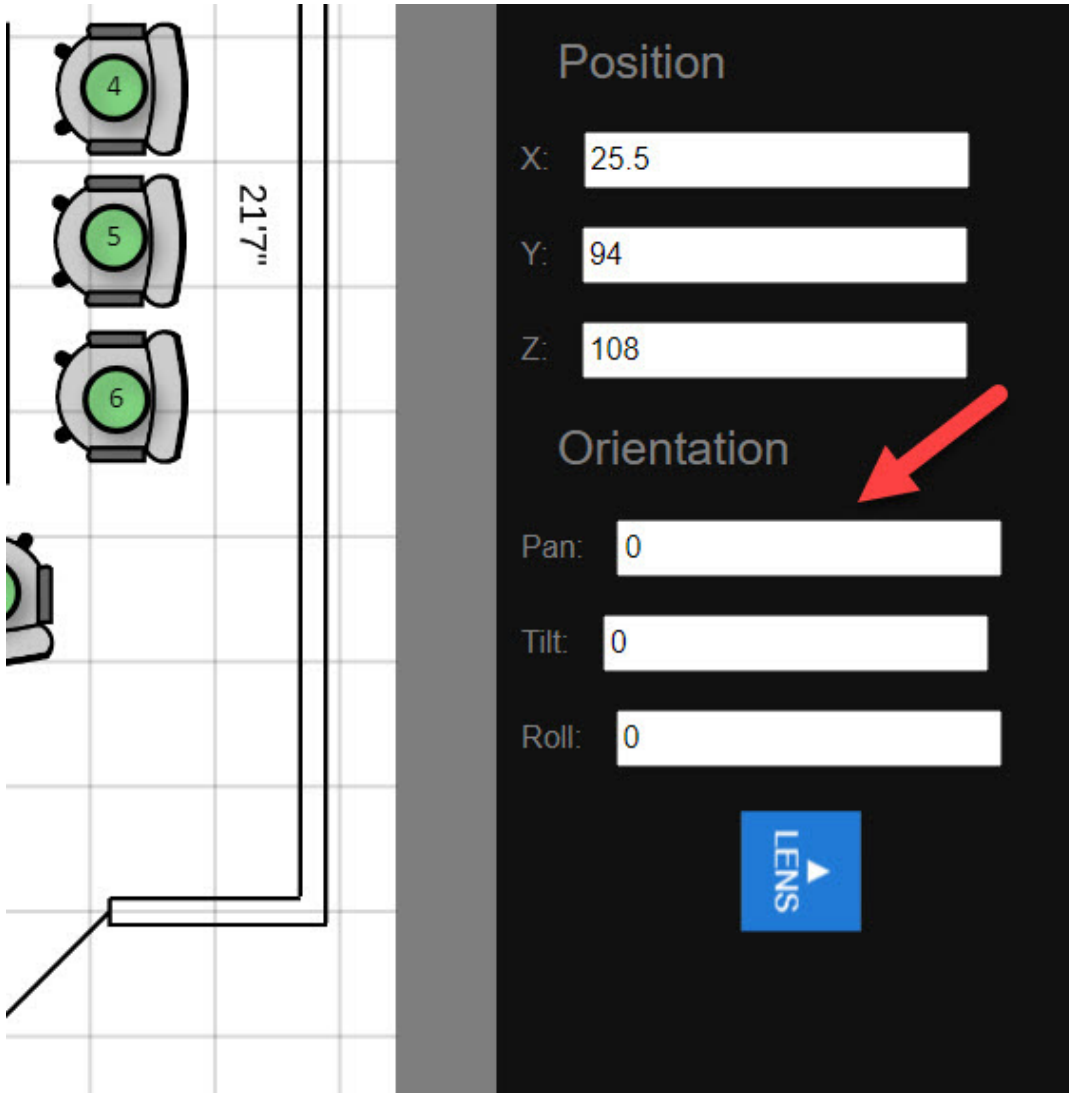

The handle sticking out of the Camera Device in the room layout can also adjust the **Pan** setting of the camera. Click and hold the handle to change this value.

**NOTE:** When adjusting the Camera Device Orientation, the Camera Device handle corresponds with the camera lens when the lens is facing forward.

#### Camera Device Handle

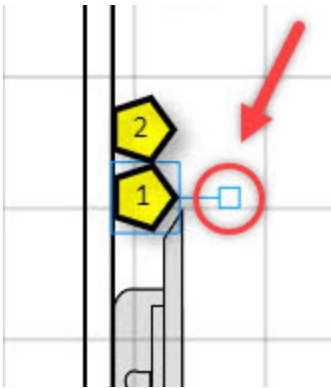

# Microphone Device Configuration

**Microphone Devices** are the microphones in a room that the Automate VX uses to receive audio from active-speaking participants. Microphone Devices are indicated in room designer as square-shaped nodes. For more information about adding Microphone Devices to a room layout, refer to [Add Microphone Device on page 44](#)

There are three different types of microphones, and each microphone type is configured differently within Room Designer.

- **Intelligent microphones:** These are microphones installed in the ceiling. Microphone Devices should be placed in the exact location where they exist physically in the room layout. Intelligent microphones have a radius that can collect audio data, and in conjunction with AutoSwitching, can broadcast audio from any position within the radius.

**NOTE:** The Shure MXA310 Table Top microphone is also considered an intelligent microphone.

- **DSPs and discussion systems:** Microphones positioned at each active speaking participant location. These are often push-to-talk microphone systems, gooseneck microphones, or any microphone system that is using a DSP. For the Microphone Device in the room layout, the location of the Microphone Device is not important and can be placed anywhere. The microphones used to track audio need to have Virtual Mics in positions where microphones are located. For more information on configuring Virtual Mics, refer to [Virtual Mic and Blocking Zone Configuration on page 78](#)

Once the **Microphone Devices** are situated in their appropriate locations within the room layout, click on a Microphone Device to open the Microphone Device Settings. This panel appears on the right side of the screen.

### Microphone Device Settings

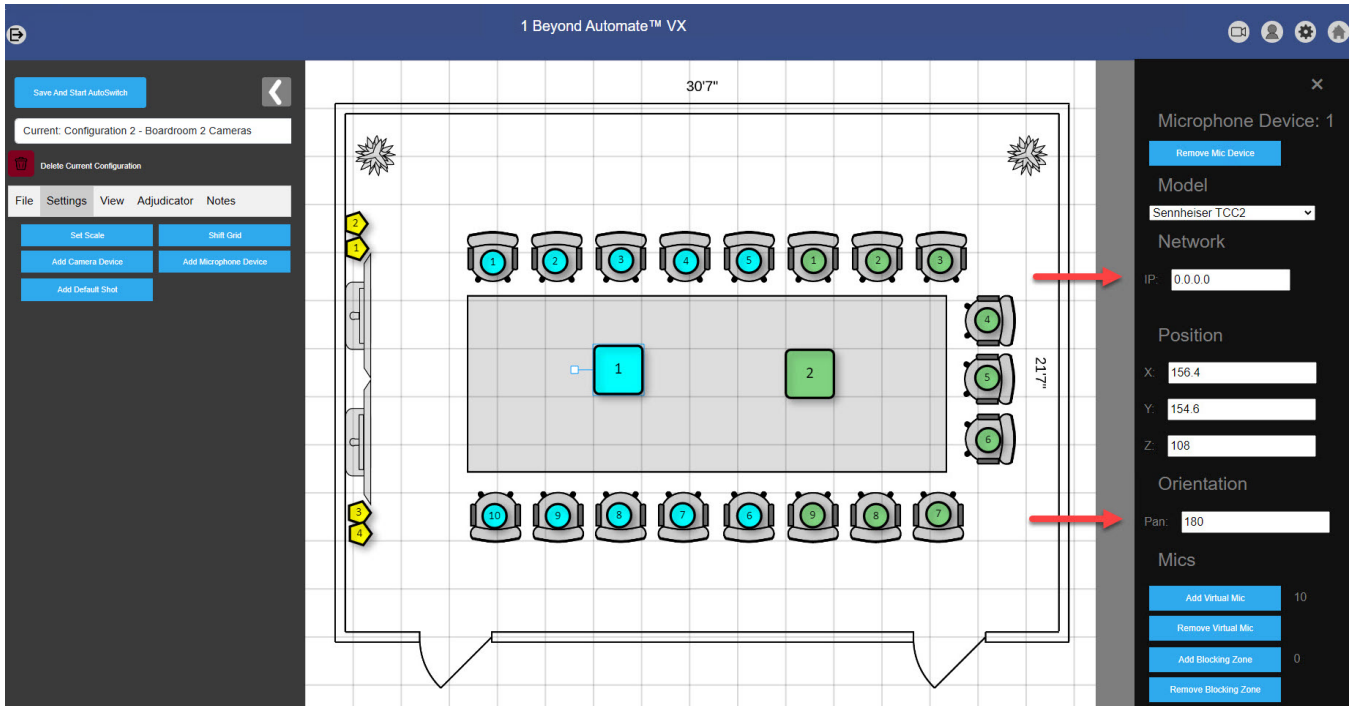

The following **Microphone Device** settings are available.

## Remove Mic Device

Select the **Remove Mic Device** button to remove the selected Microphone Device from the current configuration. This removes all settings associated with the Camera Device from the configuration.

### Remove Mic Device Button

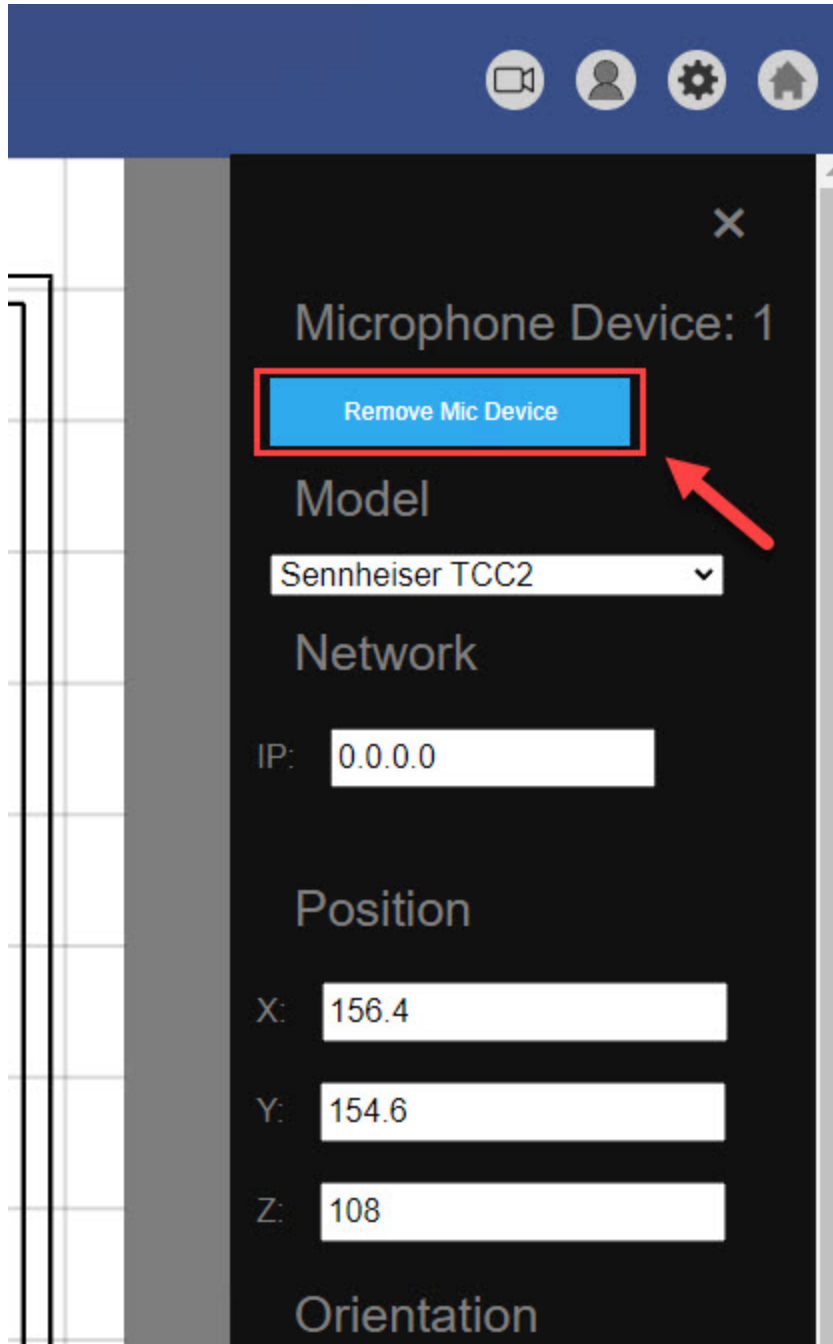

## Model

Select the drop-down menu under the **Model** title to select the microphone model for the respective Microphone Device. This should match the same model that was used in the physical room. The following microphone models are available:

- Audio Technica® ATND1061 (beta)
- Biamp Tesira
- QSC Q-SYS™ Core
- Sennheiser TCC2
- Sennhesier TCCM
- Shure Intellimix™ Room
- Shure MXA310
- Shure MXA910
- Shure MXA920 XYZ
- Shure MXA920-Lobe
- Shure MXCW
- Shure P300
- TAIDEN® Conference System
- Unknown
- Yamaha ADECIA RM-CG

## Microphone Device Model Menu

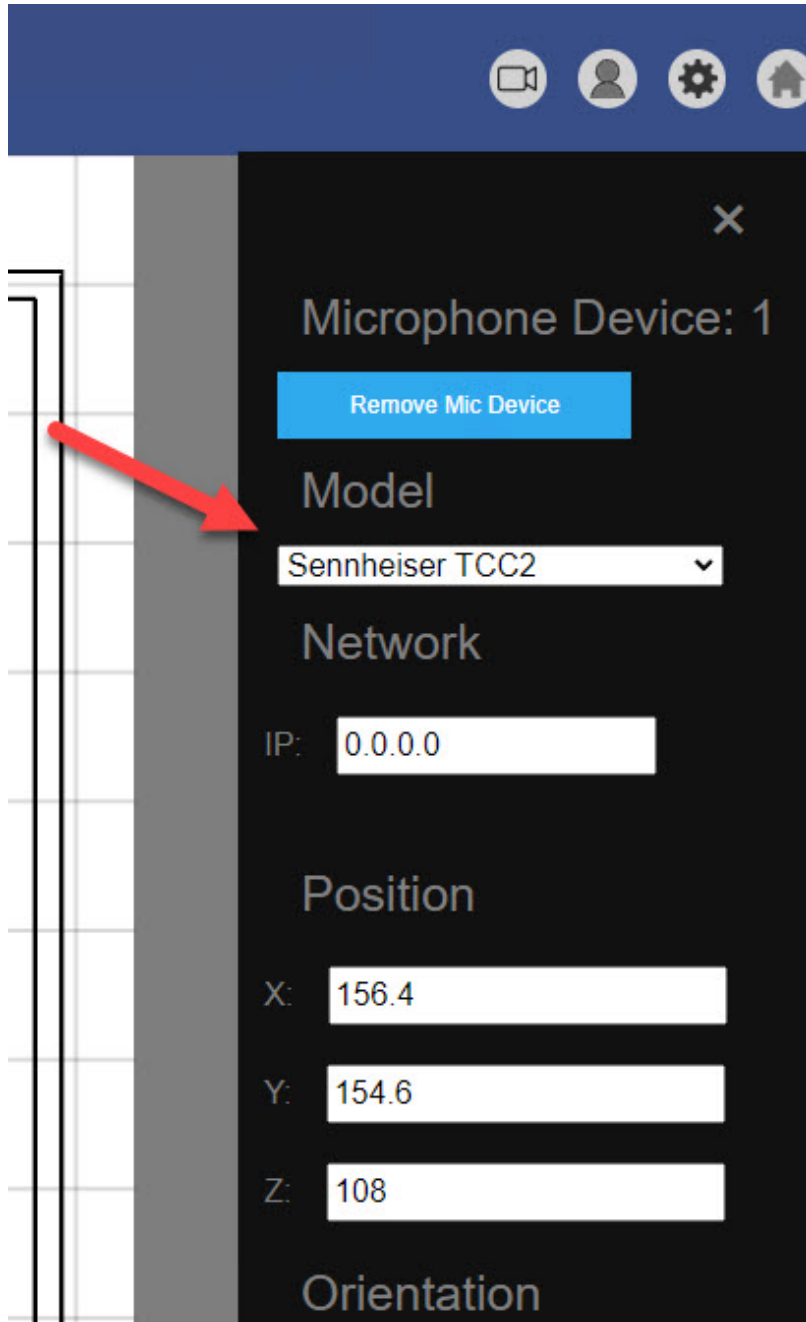

### NOTES:

- If the microphone that is being used in the room is not one of the models listed above, then select **generic**. Generic microphones may not operate properly with the Automate VX.
- When using the Shure MXA920-Lobe or Shure MXA910 as the Microphone Device, the Virtual Mic positions should match the locations of the lobes in the Shure Designer Configuration software. For more information about these Shure microphones, refer to [Shure's documentation](#).



# Network

Enter the IP address of the microphone in the **IP** text field. This allows Automate VX to connect and communicate with the microphone.

## Microphone Device Network Setting

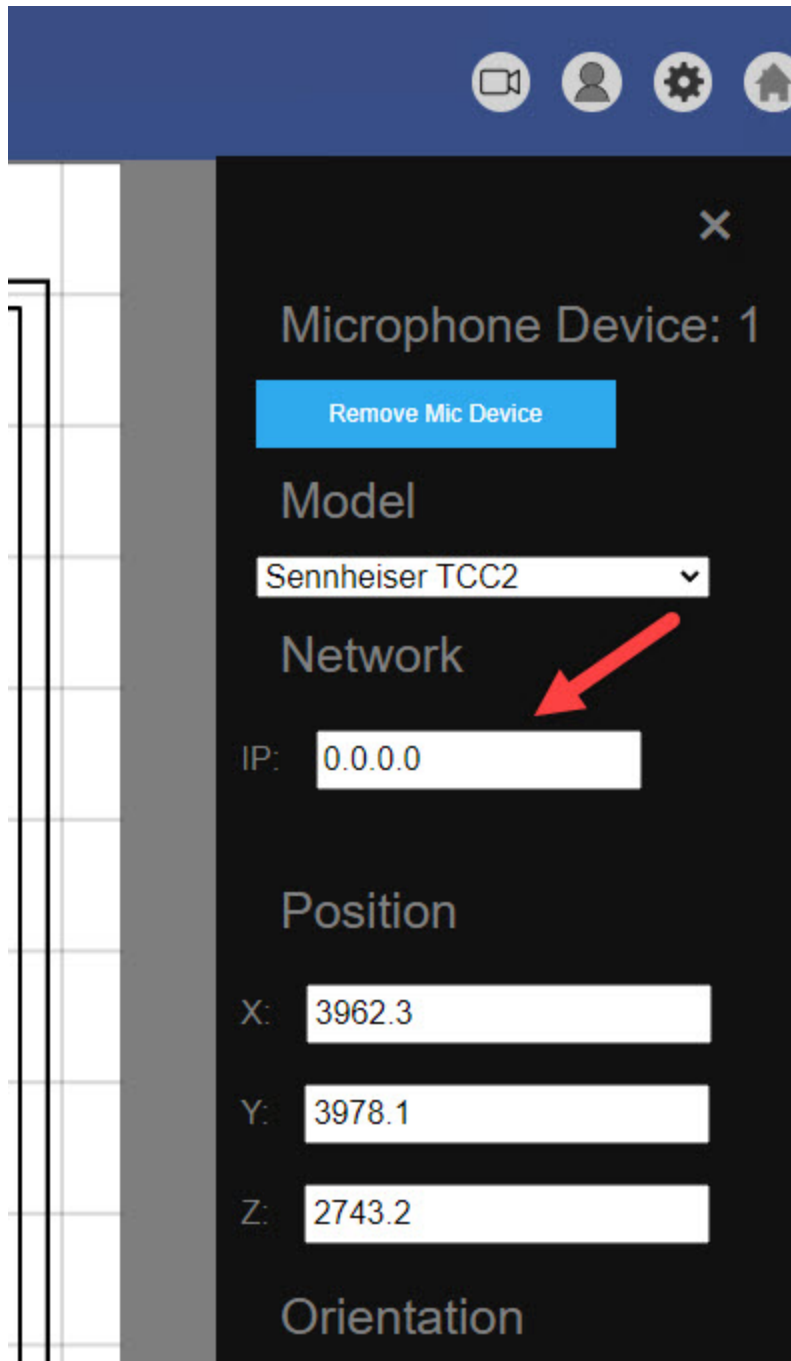

# Position

The **X**, **Y**, and **Z** fields are the coordinates of the Microphone Device in the room layout. Enter the coordinates of the Microphone Device into their respective fields, or drag the Microphone Device and place it into the desired location. The units used in the text fields are either in inches or millimeters, depending on the unit selected in the **View** tab. For more information about changing the units, refer to [Units on page 48](#)

**NOTE:** The X, Y, and Z coordinates of the Microphone Device are measured relative to the Origin Point that is set. For more information about the Origin Point, refer to [Show Origin on page 53](#)

## Microphone Device Position Setting

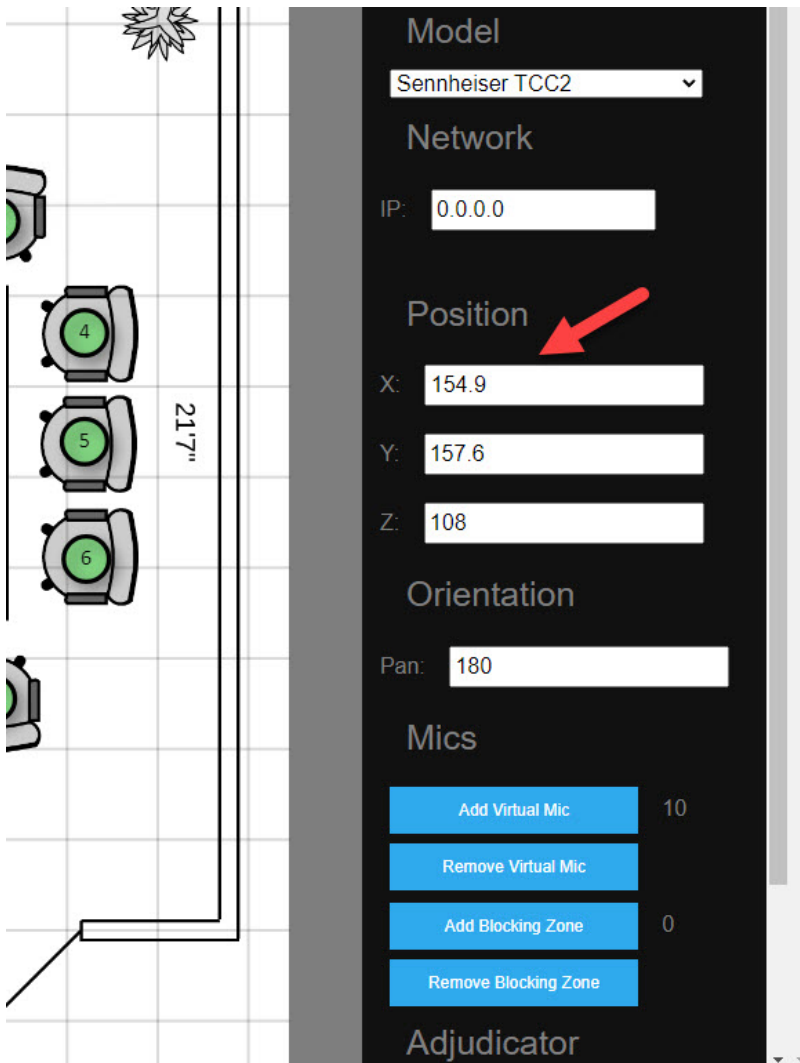

# Orientation

The **Pan** field indicates the direction that the microphone is facing. Change the value in the **Pan** field to match the Microphone Device to the physical microphone.

## Microphone Device Orientation Setting

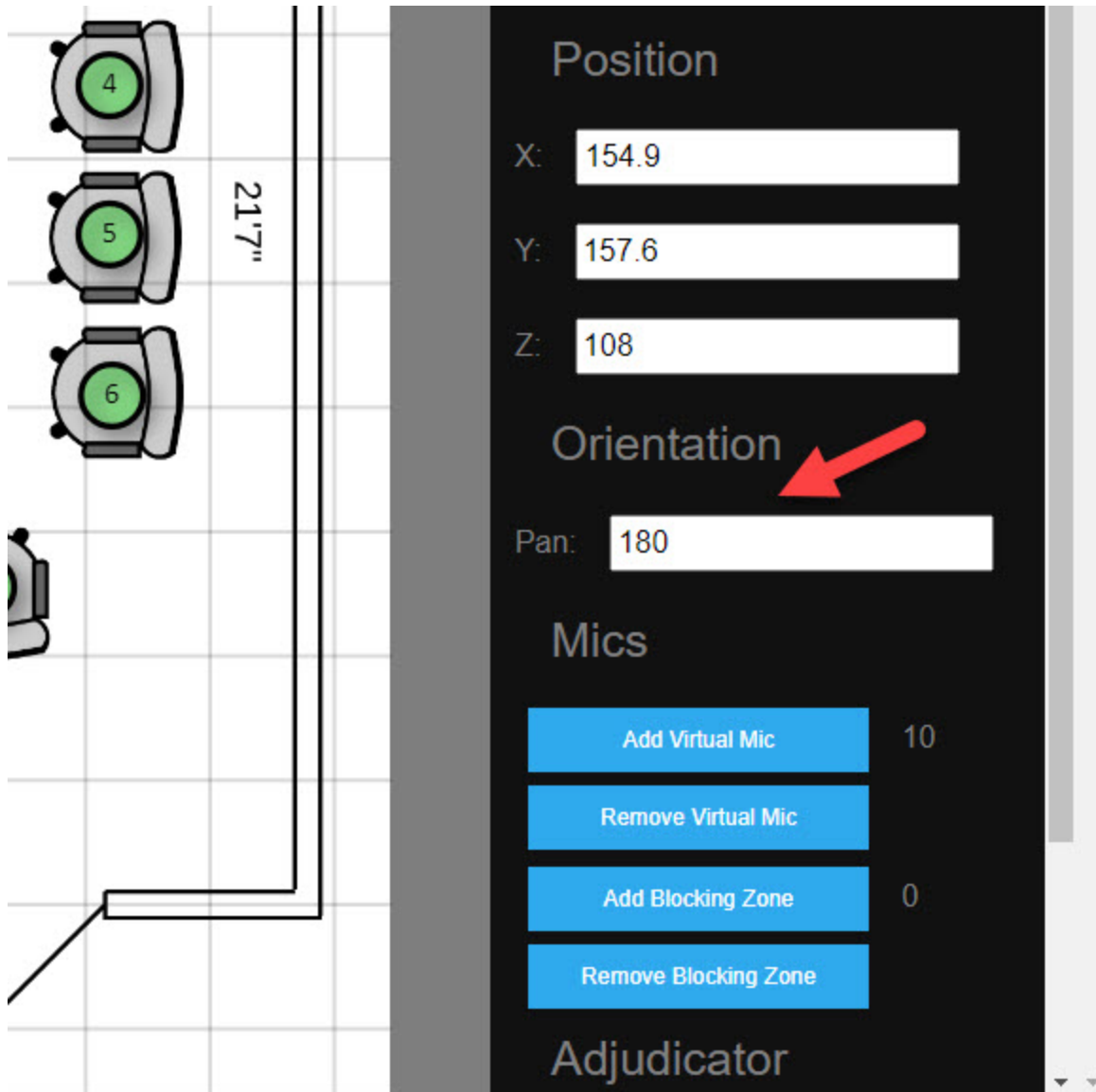

Alternatively, the handle attached to the Microphone Device can rotate the microphone. This will automatically change the value in the Pan field to reflect the orientation.

#### Microphone Device Handle

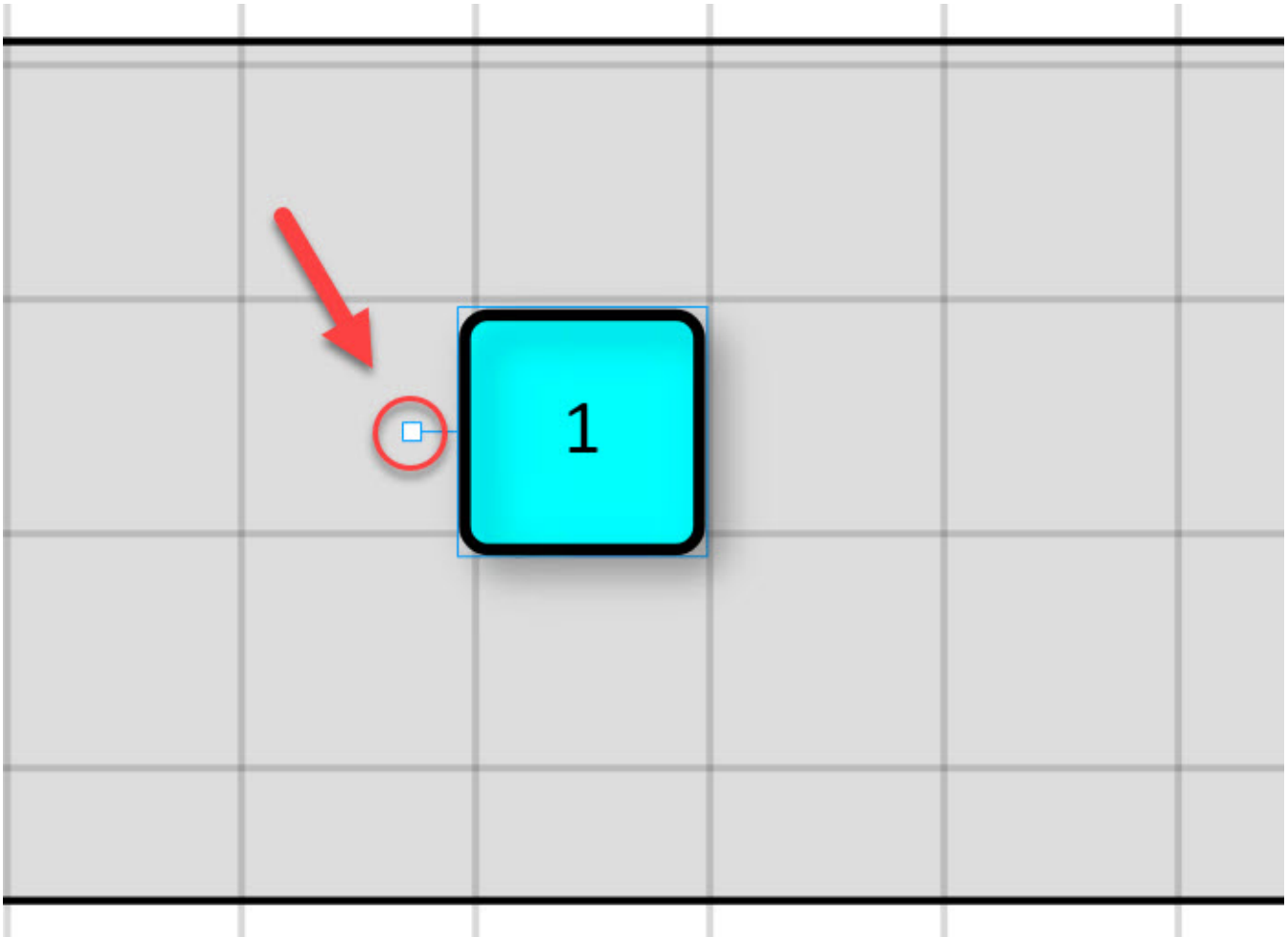

For optimal microphone performance, the Microphone Device should be oriented with the handle extending in the same direction as the manufacturer logo on the physical microphone.

## Mics

Mics settings allow for the creation and removal of Virtual Mics and Blocking Zones. For more information, refer to [Virtual Mic and Blocking Zone Configuration on page 78](#).

## Adjudicator

Input the channel that the Microphone Device will communicate with the adjudicator (if necessary). For more information, refer to [Configuring Adjudicators on page 90](#)

# Noise Threshold

Use the slider under the **Noise Threshold** setting to adjust the RMS (Root Mean Square) value of the Microphone Device. The text field below the slider can also be used to manually input an RMS value.

**NOTE: Noise Threshold** is only applicable to the Shure MXA920 XYZ Mode, Sennheiser TCC2, Sennheiser TCCM, and Yamaha ADECIA microphones. **Noise Threshold** will not function with any other microphones.

## Microphone Device Noise Threshold

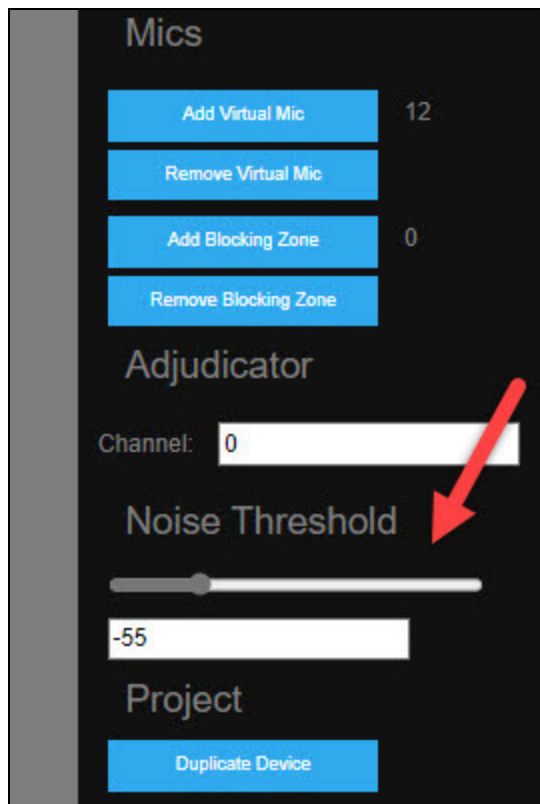

This will affect the sensitivity of the microphone when AutoSwitching is enabled. The higher the RMS value, the more noise is required to trigger Virtual Mic positions associated with the Microphone Device. Conversely, the lower the RMS value, the less noise is required to trigger Virtual Mic positions.

# Duplicate Device

Select the **Duplicate Device** button to create a copy of the currently selected Microphone Device. Once the button is clicked, click again in the desired location for the copied Microphone Device. This also duplicates all Virtual Mic positions, Blocking Zone positions, and Adjudicator settings as well.

## Microphone Device Duplicate Device Setting

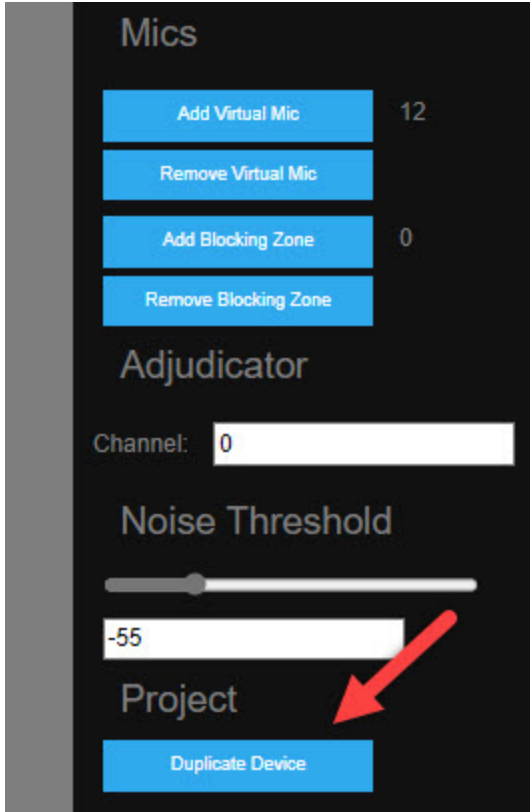

# Virtual Mic and Blocking Zone Configuration

**Virtual Mics** represent the active speaking participant positions in Room Designer. These are most often seats but can be used for standing positions as well. Virtual Mic locations in the room layout are markers for the Microphone Devices to pick up the speaking positions. The respective cameras will then switch to the Virtual Mic location.

To use Virtual Mic settings in a room layout:

1. Select the Microphone Device that is going to be tracking audio. The **Microphone Device** settings menu appears on the right side of the window.

## Microphone Device Settings

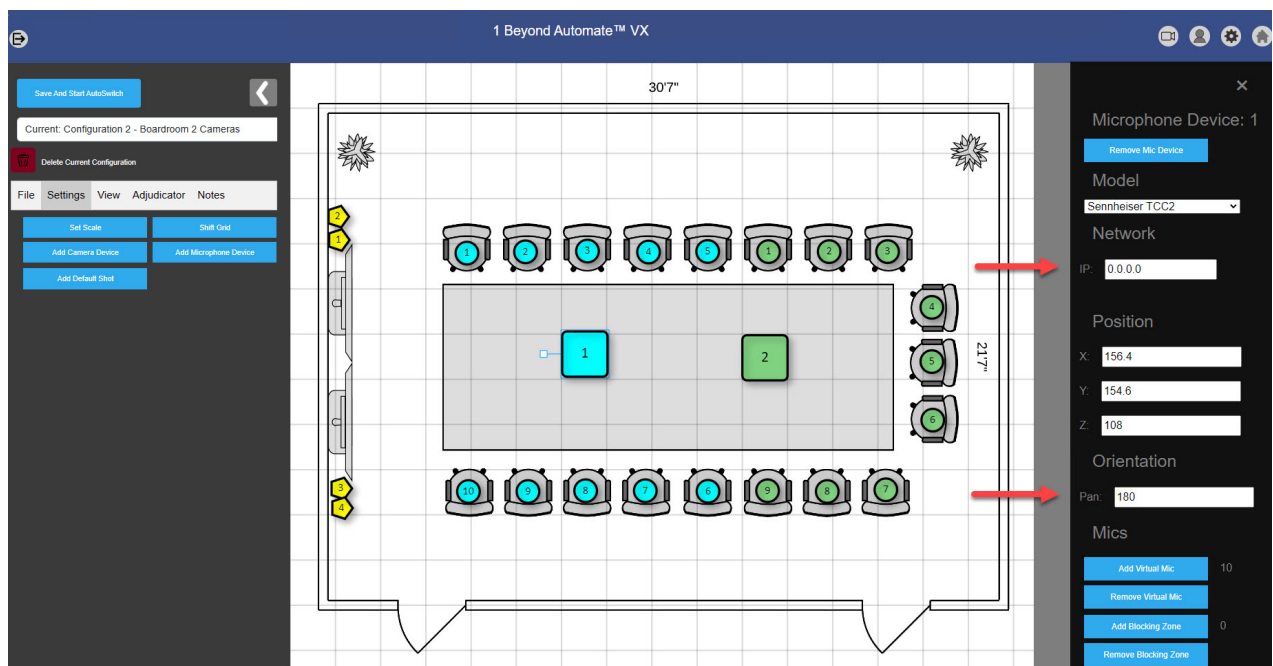

2. Navigate to the **Mics** section of the **Microphone Device** settings menu.

Microphone Device Settings: Mics

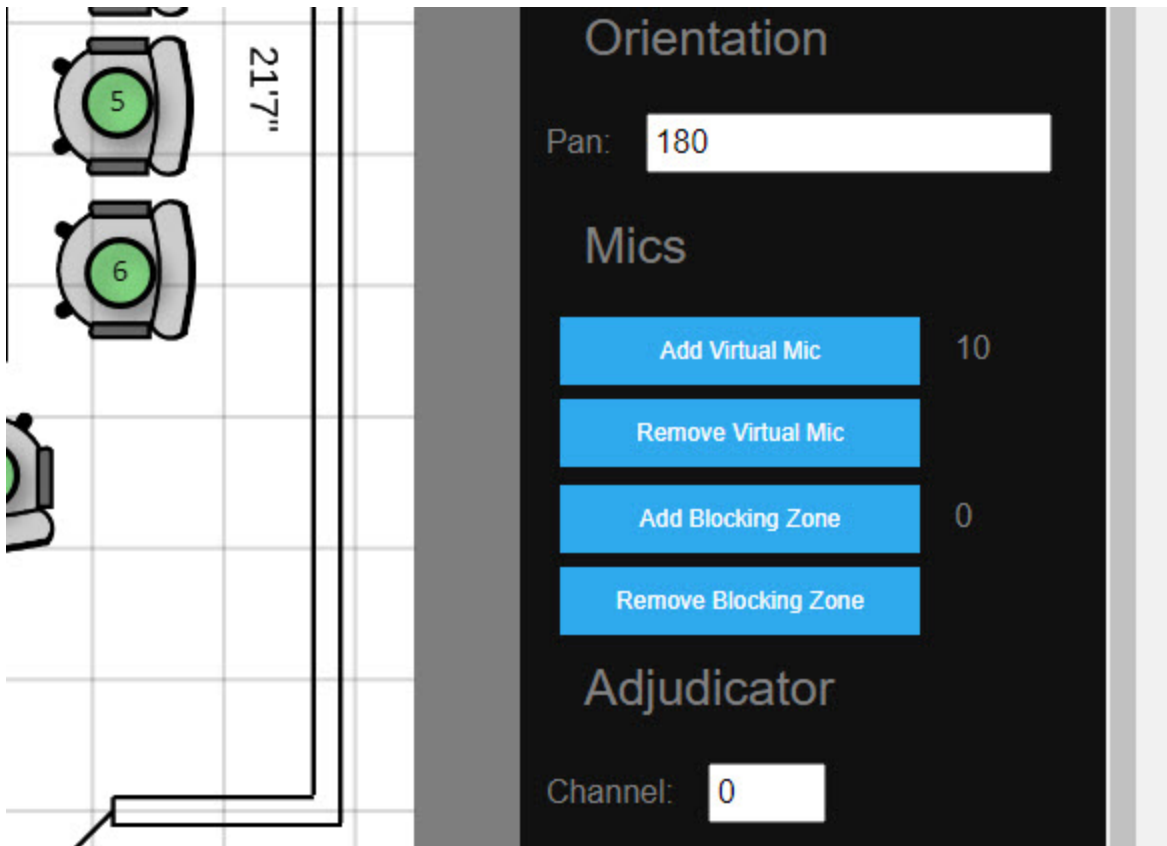



The following Virtual Mic settings are available.

## Add Virtual Mic

Select **Add Virtual Mic** to add a Virtual Mic to the room layout. The Virtual Mic will be placed directly on top of the Microphone Device. Click and drag the Virtual Mic to the position where an active speaking participant would be in the room layout. Refer to the example below for a reference of how Virtual Mics should be positioned in a room layout:

### Virtual Mic Location Example

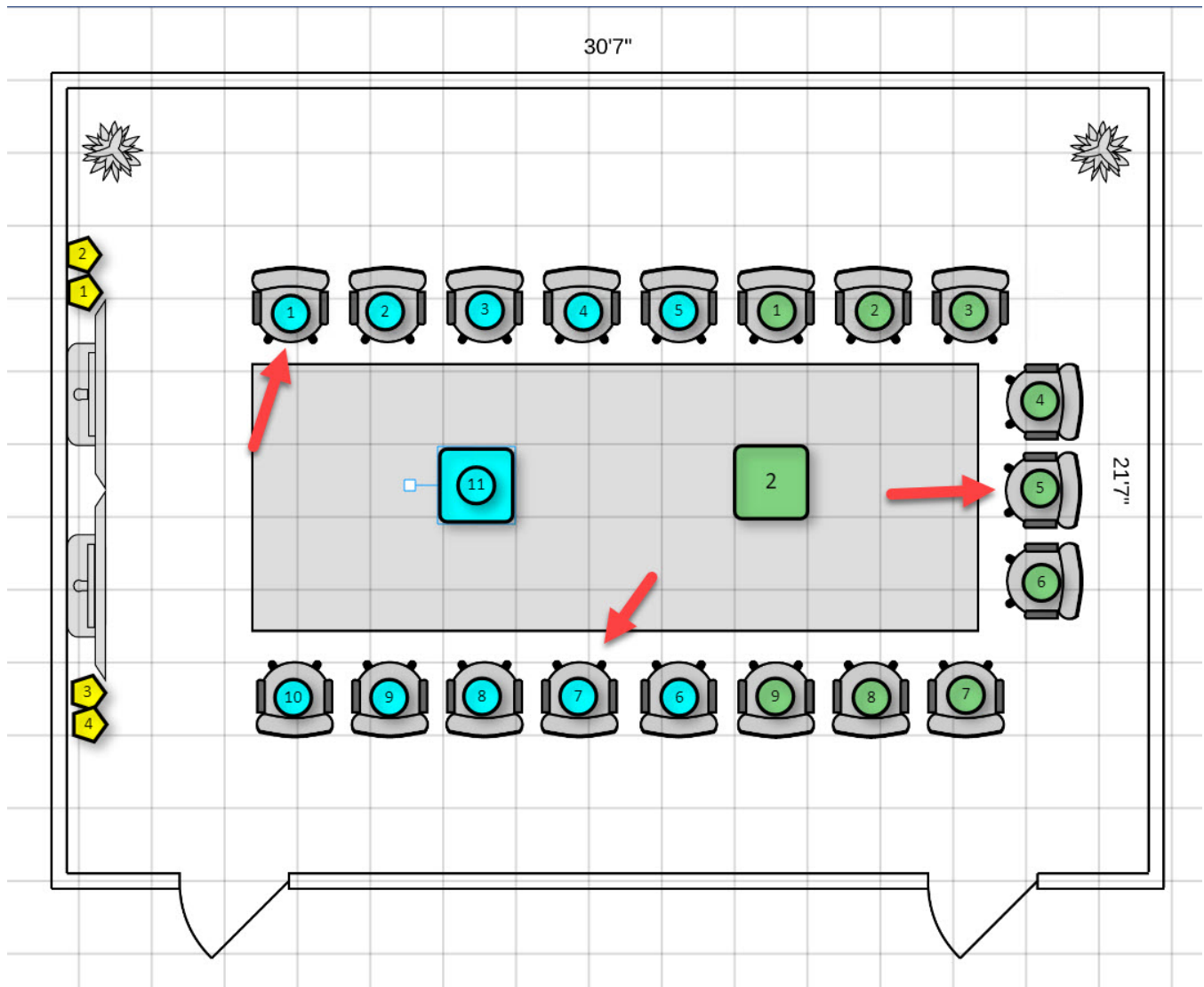

There is a Virtual Mic position in every seat in the conference room, so when someone speaks, they will be recognized as a camera shot location. Virtual Mics need to be located near their respective Microphone Devices. This is important for the Auto Switching performance between camera shots in the Automate VX. To help with this, consider turning on **Proximity Check** in the **View** menu.

For more information about Virtual Mic settings, refer to [Virtual Mic Settings on page 82](#)

## Remove Virtual Mic

Select **Remove Virtual Mic** to delete a Virtual Mic in the room layout. This will delete the highest numbered Virtual Mic associated with the Microphone Device (10, 9, then 8, and so forth).

## Add Blocking Zone

A Blocking Zone is used to mute a Microphone Device that might pick up unwanted ambient audio. This is particularly useful when there is an ambient sound in the room (vents, AC unit, and so forth). A Blocking Zone in Room Designer is indicated by a gray circle.

Select **Add Blocking Zone** to create a Blocking Zone in the room. To move the Blocking Zone, click and hold the left mouse button on the Blocking Zone and drag the cursor. Place the Blocking Zone in the room layout at the source of the ambient sound in the physical room.

**NOTE:** Blocking Zones are associated with the Microphone Device they were created from and will not work with other Microphone Devices.

### Blocking Zone

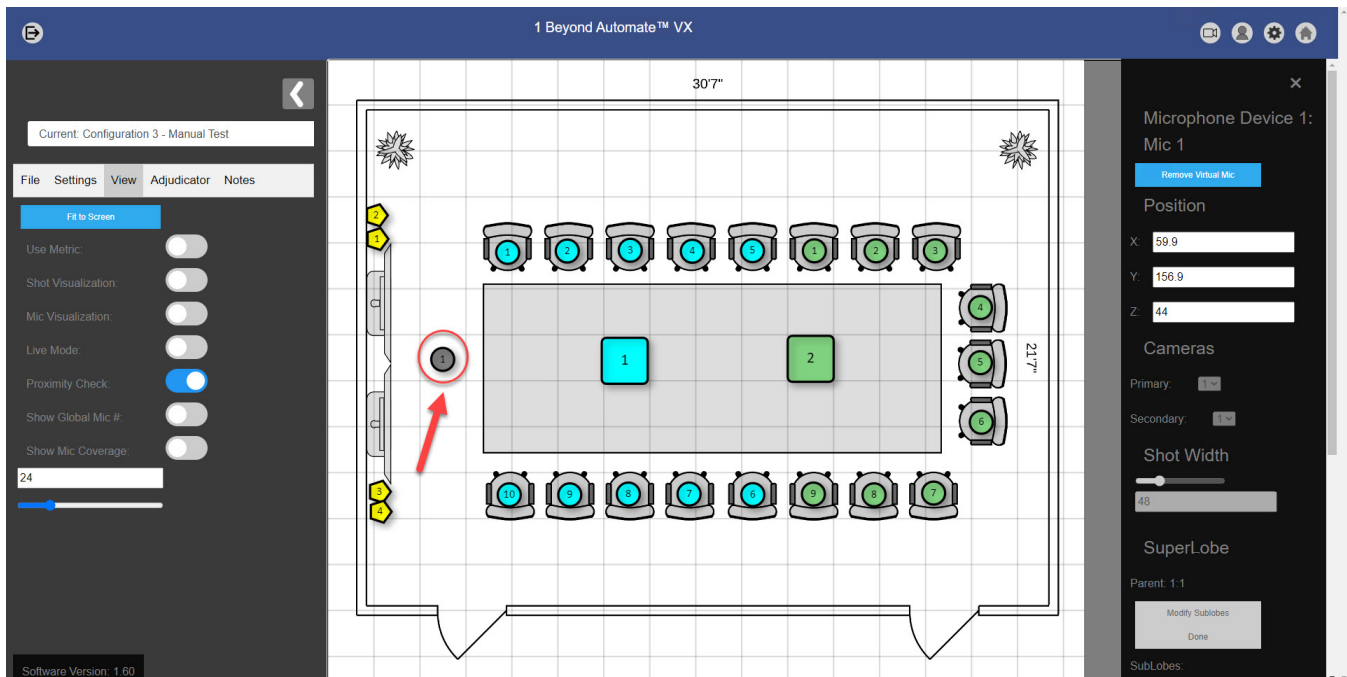

Use Blocking Zones to define the space between multiple intelligent microphones. This helps mitigate switching to the incorrect camera shot when virtual mics from multiple Microphone Devices are placed in close proximity.

## Remove Blocking Zone

Select **Remove Blocking Zone** to delete a Blocking Zone in the room layout. This will delete the highest numbered Blocking Zone associated with the Microphone Device (10, 9, then 8, and so forth).

# Virtual Mic Settings

Once a Virtual Mic is placed in the correct location, select the Virtual Mic to open the Virtual Mic Settings. The menu will appear on the right side of the screen.

## Virtual Mic Settings

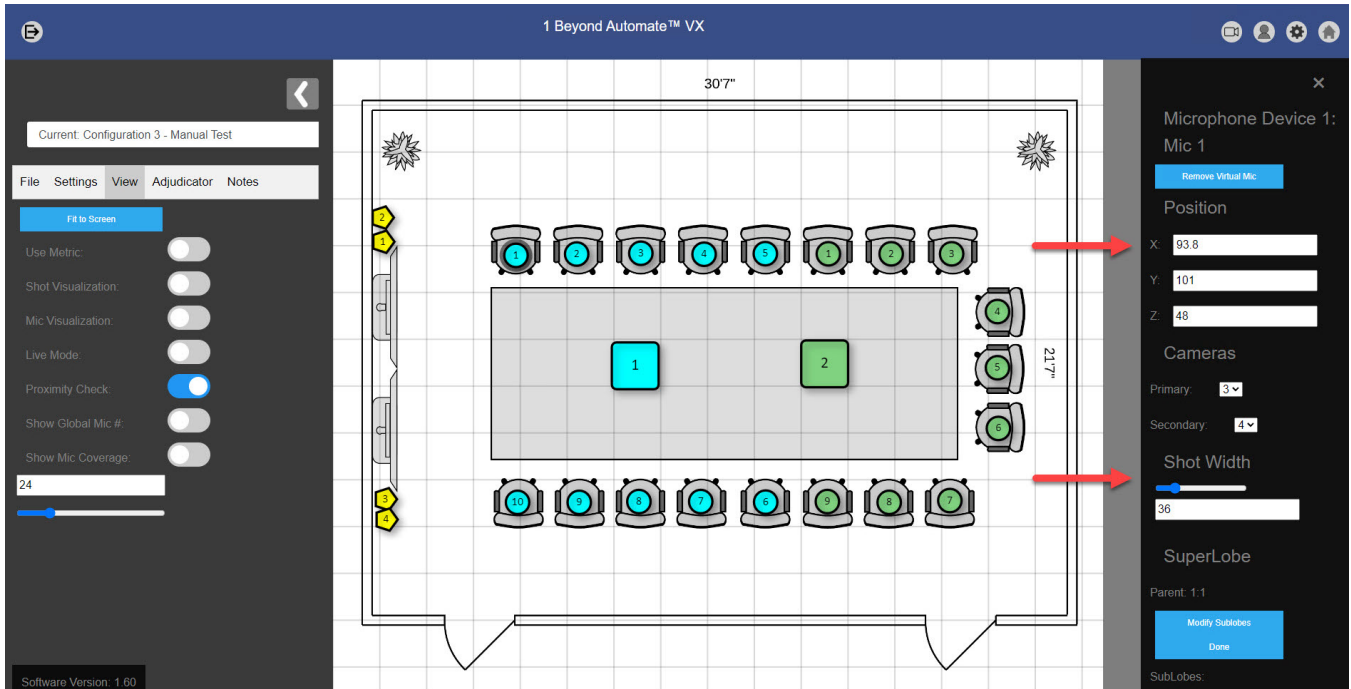

The following Virtual Mic settings are available in this menu:

## Remove Virtual Mic

Select **Remove Virtual Mic** to delete the currently selected Virtual Mic.

## Position

The **X**, **Y**, and **Z** fields are the locations of the Virtual Mic in the room layout. These coordinates can be entered manually into their respective fields, or the Virtual Mic can be dragged and placed into the correct location. The units used in the text fields are either in inches or millimeters depending on the unit selected in the **View** tab. For more information about selecting units, refer to [Units on page 48](#).

### Virtual Mic Position Setting

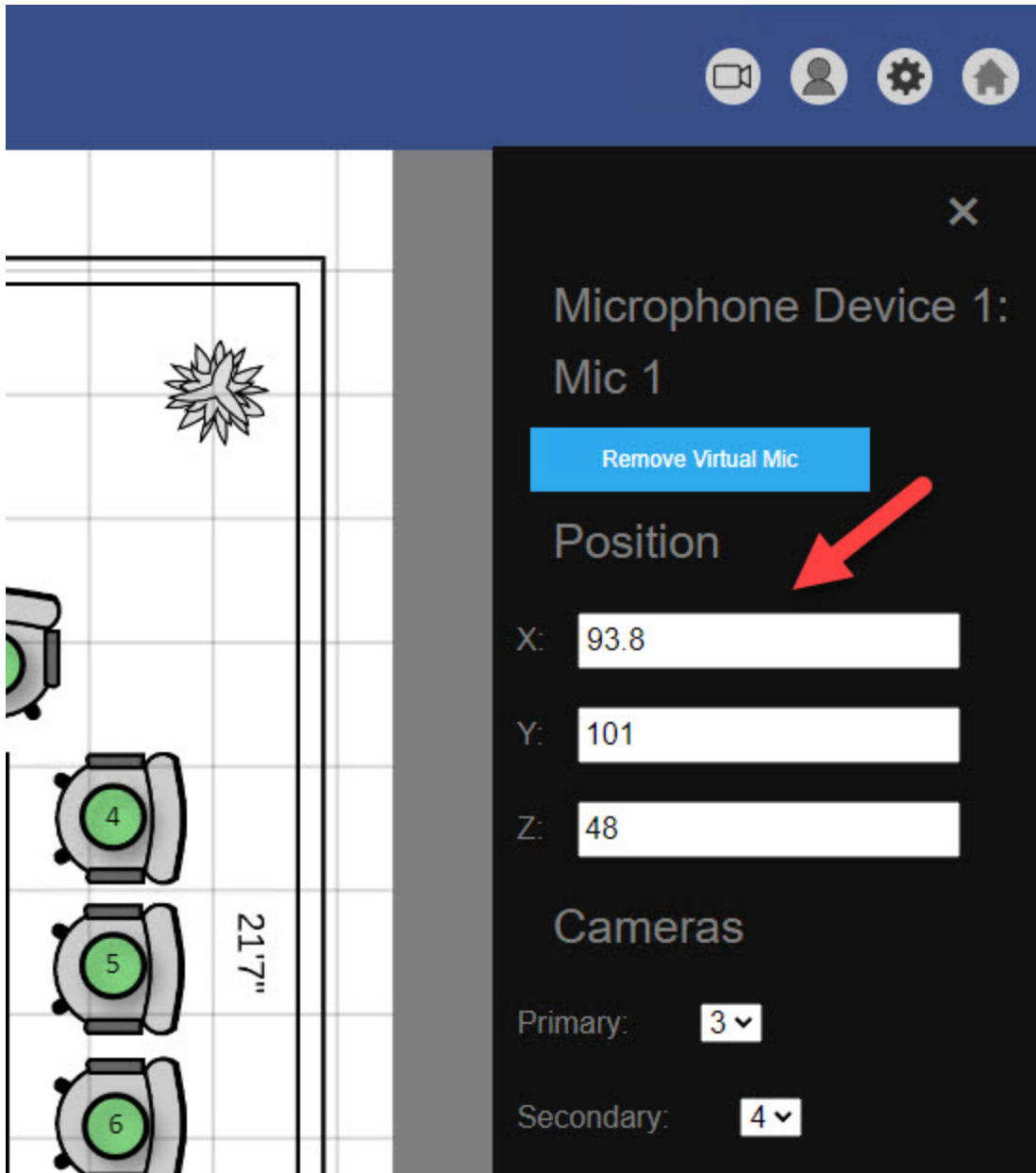

## Cameras

There are two separate drop-down menus within the **Cameras** section: one for **Primary** and one for **Secondary**. These drop-down menus are provided for cameras that will be showing the Virtual Mic position through the camera feed. Select the desired camera that will broadcast the Virtual Mic location in the **Primary** drop-down menu, and select a backup camera for the Virtual Mic in the **Secondary** drop-down menu.

When possible, ensure that there are always two different cameras set up for a Virtual Mic position. Consider enabling the **Shot Visualization** and **Live Mode** options in the **View** tab to help determine that the proper cameras are set to broadcast the Virtual Mic's location.

### Virtual Mic Cameras Setting

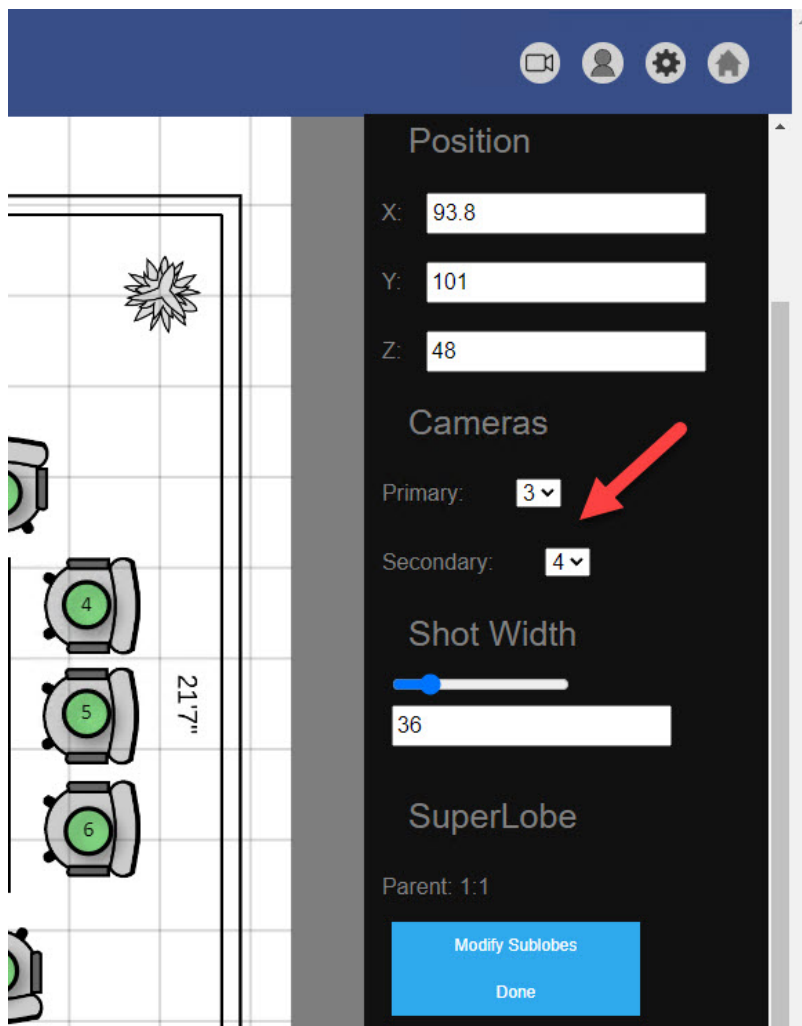

**NOTE:** For 1 Beyond AutoTracker 3 cameras, select the camera number associated with the AutoTracker 3 in both the **Primary** and **Secondary** drop-down menus.

## Shot Width

Use the **Shot Width** slider or input a value into the text field to change the size of the camera shot. Enable **Shot Visualization** in the **View** tab to see the size of the camera shot in the room layout. Enable **Live Mode** in the **View** tab to see how the **Shot Width** affects the camera shot in real-time on Wirecast.

**NOTE:** The maximum and minimum values available for **Shot Width** are determined by the selected camera's field of view specifications. This does not apply to cameras selected under the **generic** option. For more information about supported cameras, refer to [Camera Device Configuration on page 59](#)

### Virtual Mic Shot Width Setting

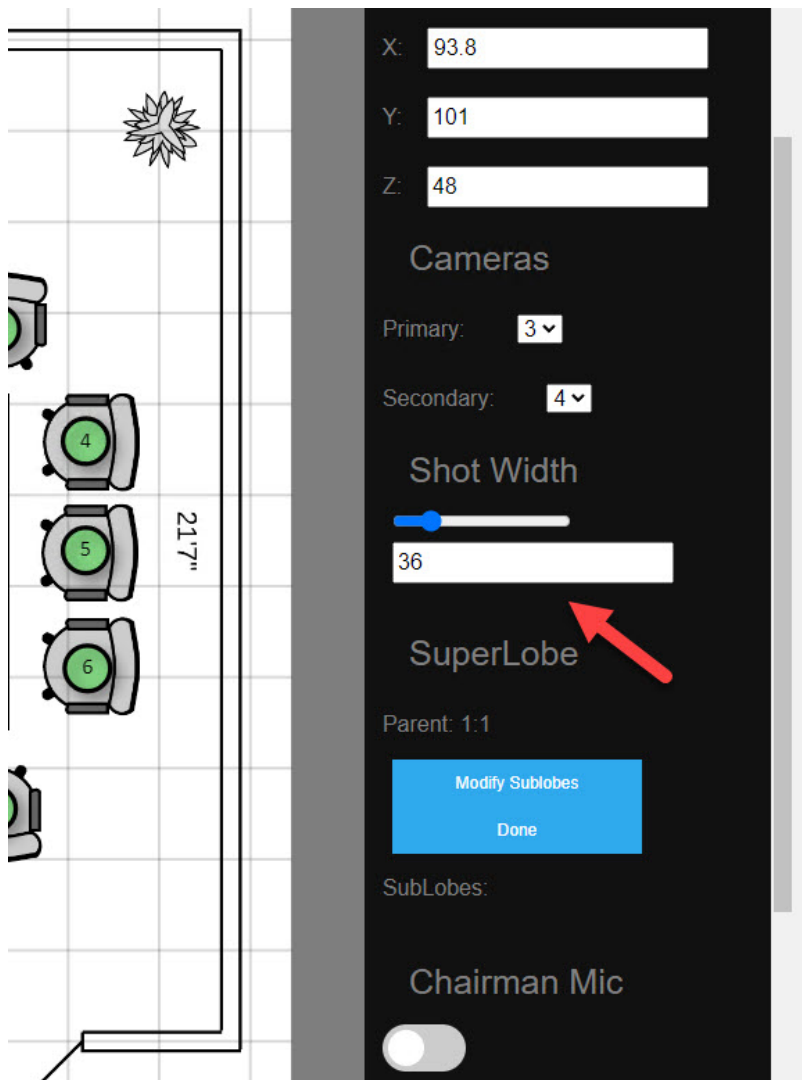

## SuperLobe

A SuperLobe contains a group of Virtual Mic positions. The grouped Virtual Mic positions associated with the SuperLobe are SubLobes. When the Microphone Device detects audio from a SubLobe, the Camera Device will set the camera shot on the SuperLobe position rather than the specific SubLobe position.

### Virtual Mic SuperLobe Setting

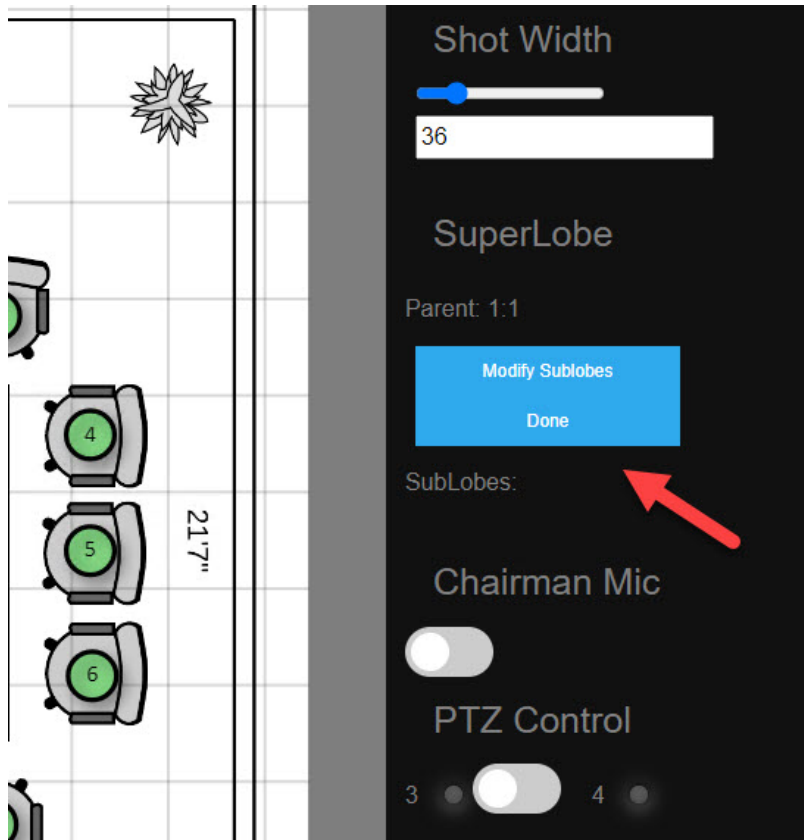

Use a SuperLobe when there are multiple Virtual Mics and the microphone cannot accurately determine audio between the Virtual Mic positions. Perform a **Proximity Check** to see if the microphone can accurately determine Virtual Mic positions. For more information about **Proximity Check**, refer to [Proximity Check on page 51](#).

In the following example, the Virtual Mic positions do not pass the **Proximity Check** (indicated by red lines between Virtual Mic positions). Virtual Mic **11** is the SuperLobe, and Virtual Mics **3** and **4** are SubLobes. The camera uses Virtual Mic **11** to create a single camera shot displaying all three of the Virtual Mic positions.

#### SuperLobe Example

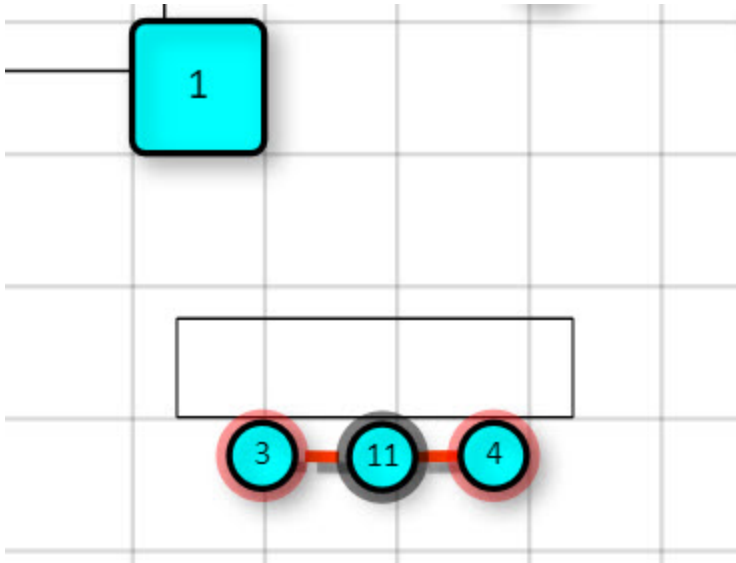

To configure a SuperLobe and SubLobes:

1. Select the Virtual Mic that is going to be a SuperLobe by clicking the left mouse button on the Virtual Mic.
2. Select **Modify Sublobes** to set the Virtual Mic as the SuperLobe. This enters sublobe mode where the grouping of Virtual Mics occurs.
3. Select the other Virtual Mic positions that are to be grouped into the SuperLobe. A red circle will appear around each selected Virtual Mic, indicating the Virtual Mics are now SubLobes of the SuperLobe. The SuperLobe is marked with a gray circle around the Virtual Mic.

**NOTE:** The camera shot for the Superlobe position can be changed and saved with PTZ controls. For more information about PTZ controls, refer to [PTZ Control on page 90](#)

4. Once the SubLobes are configured, select the blue **Done** button to confirm changes and exit sublobe mode.



Identify SuperLobes and SubLobes by selecting a Virtual Mic position. Select a SuperLobe to display all SubLobes with a red outline around the Virtual Mic positions.

#### SuperLobe Selected



Select a Sublobe to display the SuperLobe that it is grouped with. A green outline is displayed around the SuperLobe Virtual Mic position.

#### Sublobe Selected



To remove a SubLobe from the SuperLobe:

1. Select the Virtual Mic that is a SuperLobe by clicking the left mouse button on the Virtual Mic.
2. Select **Modify Sublobes** to enter sublobe mode.
3. Select the Virtual Mic (SubLobe) to remove it from the SuperLobe. Repeat until all desired SubLobes are removed from the SuperLobe.

**NOTE:** The SubLobes of a SuperLobe are indicated on the **Superlobe Virtual Mic** under the **SubLobes** header.

4. Once all the desired SubLobes are removed from the SuperLobe, select the blue **Done** button to confirm changes and exit sublobe mode.

## Chairman Mic

Enable **Chairman Mic** to designate the currently selected Virtual Mic as a chairman. This means that whenever audio is picked up from this Virtual Mic location, it will take priority over the other Virtual Mic positions. The camera shot switches to that Virtual Mic position regardless of audio signals from other Virtual Mic positions.

### Virtual Mic Chairman Setting

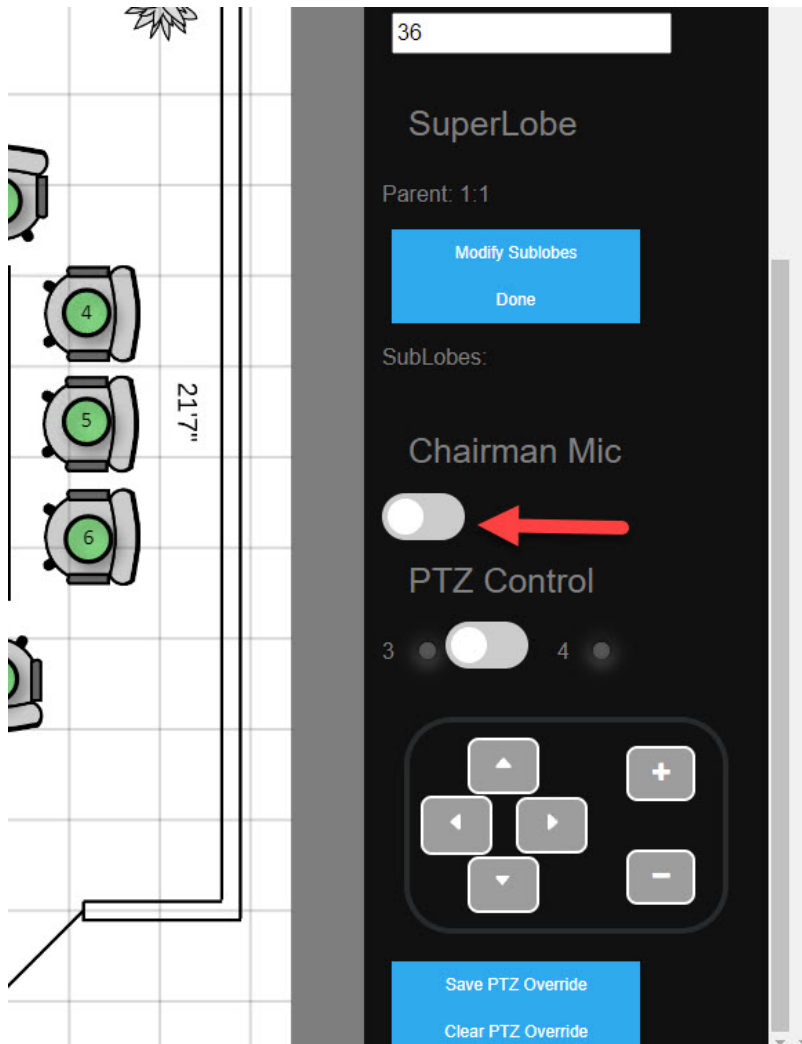

## PTZ Control

**NOTE:** This setting is only available on Automate VX systems.

PTZ controls adjust how a camera will display the Virtual Mic position. For the best results, enable **Live Mode** in the **View** tab to see how these settings change the camera shot in Wirecast.

### Virtual Mic PTZ Controls

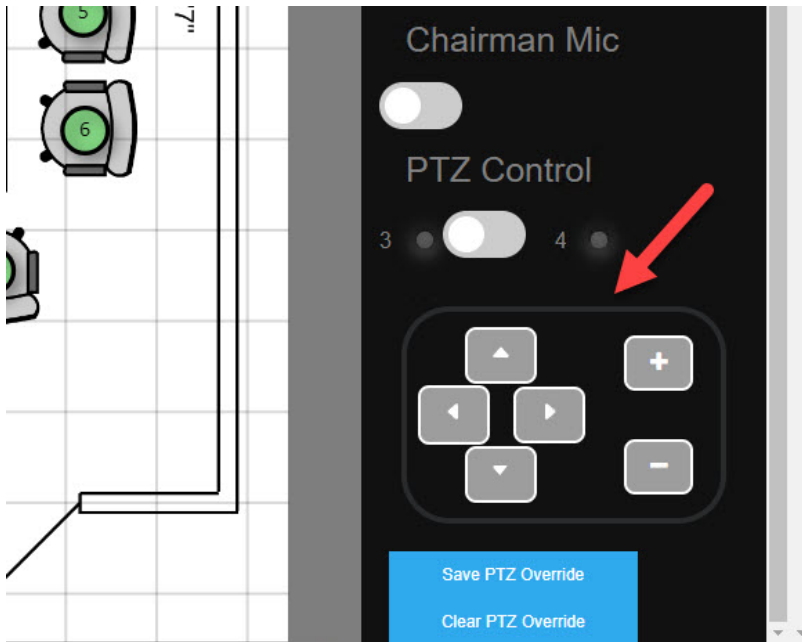

The PTZ Control switch indicates which camera is being edited. By default, the switch is set to the Primary camera (in the pictured example, 3 is the Primary camera). Move the switch to the right to edit the Secondary camera (in the pictured example, 4 is the Secondary camera). To change which cameras are the Primary and Secondary cameras for a Virtual Mic, refer to [Cameras on page 84](#)

Use the arrow buttons to change the angle that the camera shot will display. Use the + (zoom in) and - (zoom out) buttons to zoom the camera shot in or out. Once the desired shot is configured, select the blue **Save PTZ Override** button. To clear any PTZ settings set for the Virtual Mic, select the blue **Clear PTZ Override** button.

## Configuring Adjudicators

**NOTE:** This setting is only available on Automate VX systems.

Adjudicators are used when there is more than one Microphone Device in a room. The adjudicator helps the microphones determine which microphone is the closest to the audio source.

**NOTE:** Before setting Microphone Devices to channels for the adjudicator, ensure that a DSP is configured in the **Adjudicator** tab on the left side of the screen. For more information about setting up a DSP as an adjudicator, refer to [Adjudicator Settings on page 57](#).

To configure a DSP or discussion system as an adjudicator with microphones in Room Designer:

1. Select the Microphone Device to make the Microphone Device settings appear on the right side of the screen.
2. Locate the **Adjudicator** setting in the Microphone Device settings menu.

### Adjudicator Setting

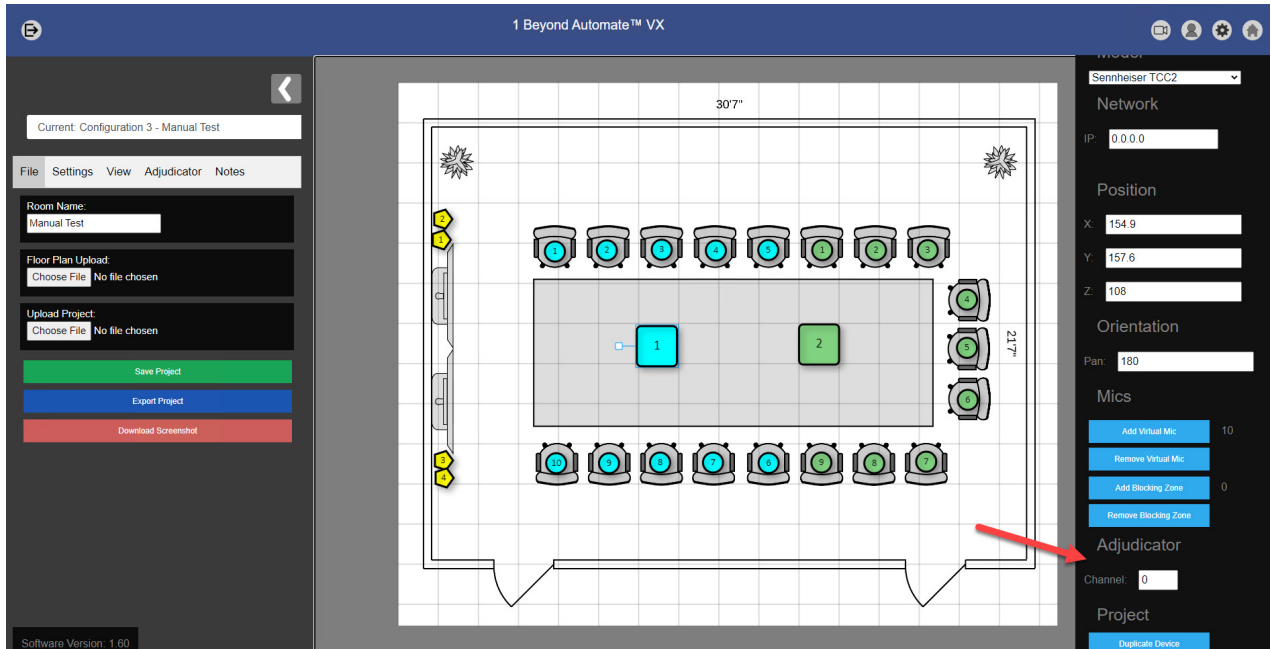

3. In the **Channel** text field, input the desired channel that will be used for communication between the microphone and the adjudicator. Ensure each Microphone Device is on its own channel. Automate VX will not operate properly if multiple Microphone Devices are on the same channel.

For rooms that have standard and intelligent microphones working in tandem, set a Microphone Device to **Channel 0** and add a Virtual Mic for each standard microphone in the room. Then, set the intelligent microphones to subsequent channels.

**NOTE:** A standard microphone refers to any microphone that is not an intelligent microphone. For more information about configuring microphones, refer to [Microphone Device Configuration on page 67](#).

The following procedure describes an example scenario for setting two standard microphones and two intelligent microphones in a room layout.

1. Create one Microphone Device, and place it anywhere in the room (location is not important). This Microphone Device is serving as the DSP or discussion system for Automate VX. For more information about creating Microphone Devices, refer to [Add Microphone Device on page 44](#)
2. Set the **Channel** in the **Adjudicator** setting to 0 for the Microphone Device.

3. Create two (or more) Virtual Mics, and place them in the exact locations where standard microphones are in the room. These Virtual Mics occupy **Channel 1** and **2** respectively, but do not need to be set in Automate VX. For more information about creating Virtual Mics, refer to [Add Virtual Mic on page 80](#).

**NOTE:** For more than two standard microphones, place additional Virtual Mics with subsequent **Channel** numbers. The third Virtual Mic would occupy **Channel 3**, the fourth Virtual Mic would occupy **Channel 4**, and so forth.

4. Create two Microphone Devices, and place them in the exact locations of the intelligent microphones in the room.
5. Set the **Channel** in the **Adjudicator** setting to 3 for one intelligent microphone, and 4 for the other.

**NOTE:** The intelligent microphones should always be on higher numbered channels than the standard microphones. For example, if the standard microphones occupy channels 1, 2, 3, and 4, the intelligent microphone channels would begin at **Channel 5** and higher.

# AutoSwitch Preview

**NOTE:** AutoSwitch Preview is only available on Automate VX systems.

The AutoSwitch Preview setting shows live positional data from audio sources within the room layout. To enable AutoSwitch Preview, select the **Save and Start AutoSwitch** button in the top left of Room Designer.

## Save and Start AutoSwitch Preview

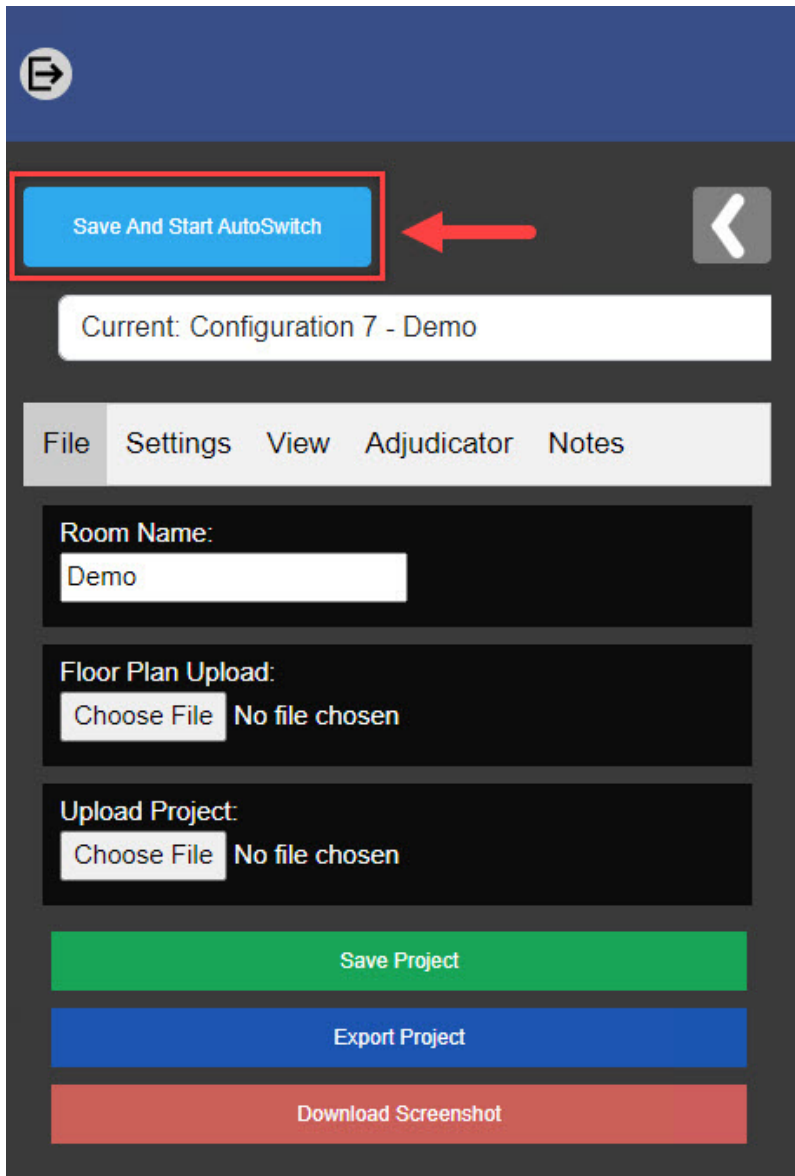

The button displays **Stop AutoSwitch** if AutoSwitching is currently on for the system. Select **Stop AutoSwitch** to turn off AutoSwitching. AutoSwitch Preview is only available if AutoSwitching is turned off.

**NOTE:** The **Stop AutoSwitch** button turns off AutoSwitching, but this can be done through the **Main** tab too. For more information on the **Main** tab, refer to [Main Menu on page 181](#).

### Stop AutoSwitch Preview

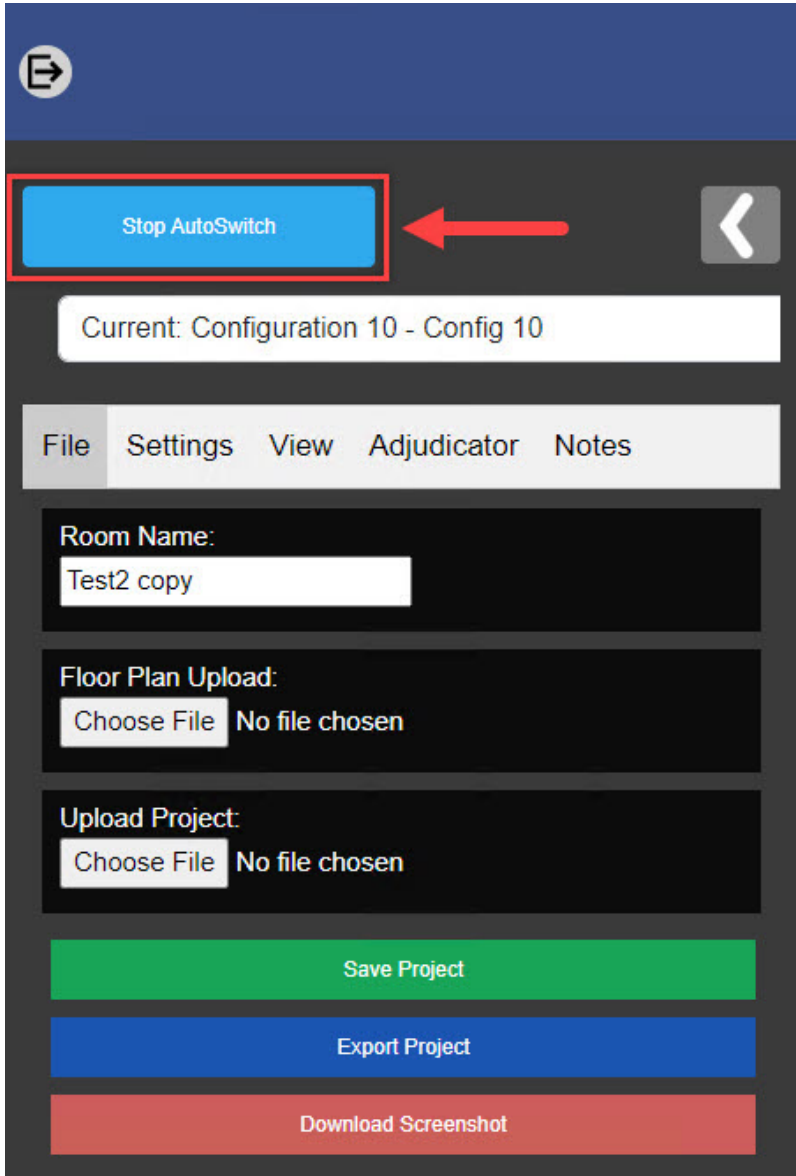

Enable AutoSwitch Preview to have Microphone Devices display where they are actively detecting audio in the room. This is indicated by lines extending from the Microphone Devices towards the location where audio is detected. The color of the line indicates which Microphone Device is associated with the line (a blue line is tied to Microphone Device 1, a green line is tied to Microphone Device 2, and so forth).

**AutoSwitch Preview Detection**

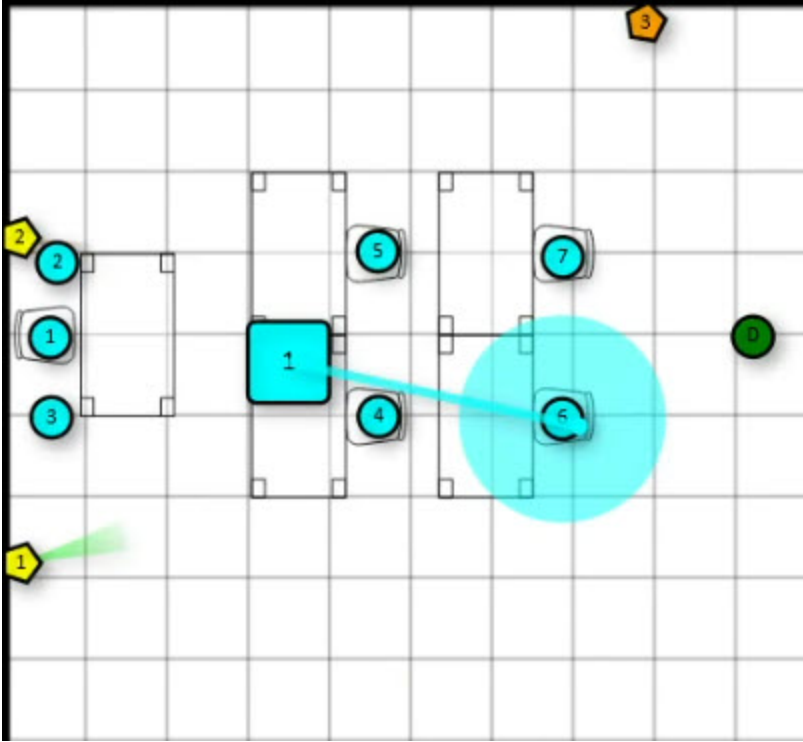



If the line extending from the Microphone Device has dashes, then the detected audio is outside of the Virtual Mic coverage area. For more information about Virtual Mic coverage, refer to [Show Mic Coverage on page 55](#)

**NOTE:** The end of the line extending from the Microphone Device is associated with the height of the nearest Virtual Mic position. If the Microphone Device is determining that a Virtual Mic position is out of range, perform one of the following:

- Adjust the height of the nearby Virtual Mic so that the microphone's detection beam intersects with the Virtual Mic's location.
- Move the Virtual Mic to a location where the height of the Virtual Mic intersects with the microphone's detection beam.

### Out of Range Audio Detection

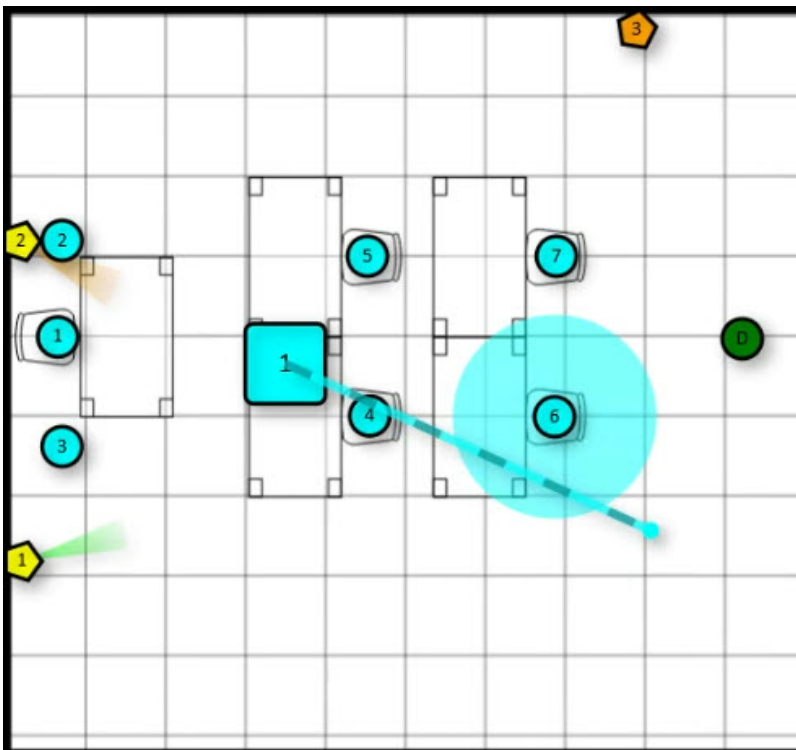

The circle around the Virtual Mic position indicates whether the speaker was audible for long enough for the **Noise Delay** threshold to be met. For more information regarding **Noise Delay**, refer to [AutoSwitch Settings on page 108](#).

If the circle around the Virtual Mic position is filled, then the Noise Delay threshold was met. If the circle around the Virtual Mic position is not filled, then the Noise Delay threshold was not met. The system will not switch the camera shot to the Virtual Mic position if the circle is not filled.

### Noise Delay Indicator

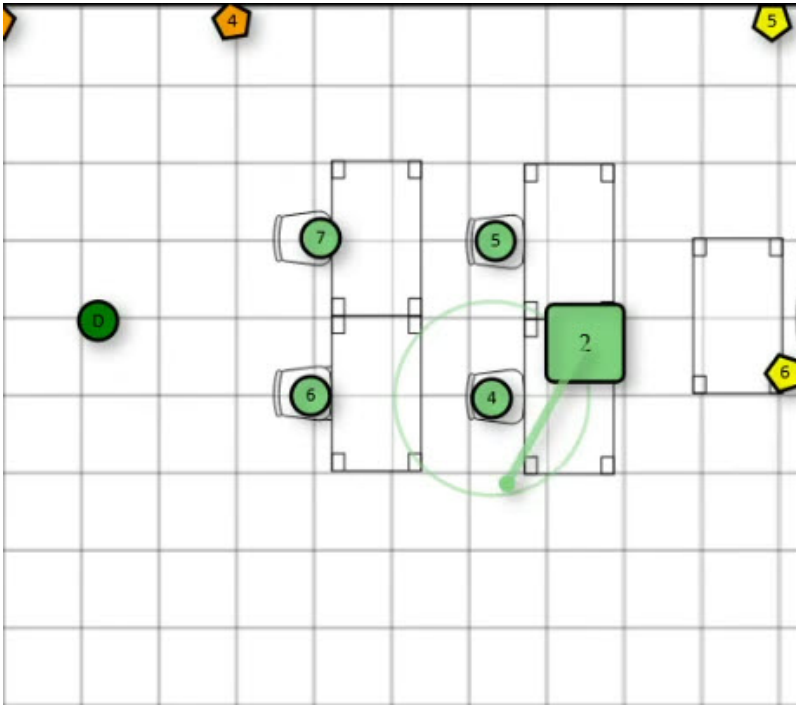

The primary and secondary cameras display their status during AutoSwitch Preview:

- A green cone extending from the Camera Device indicates the active camera and its camera shot. The direction the cone is facing the same direction as the camera lens.

### Active Camera Shot Indicator

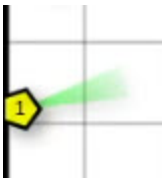

- The width of the cone extending from the Camera Device displays the current Shot Width of the camera shot.

### Wide Camera Shot Indicator



- Intelligent cameras (i20, i12, and AutoTracker 3 cameras) do not have a cone that extends from the Camera Device when it is active. A green circle around the Camera Device indicates that the intelligent camera is active.

#### Active Intelligent Camera Indicator

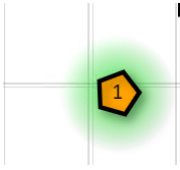

- An orange cone extending from the Camera Device indicates the camera is being prepared to switch to another camera shot. The direction the cone is facing is the direction the camera's lens is facing.

#### Prepping Camera Shot Indicator

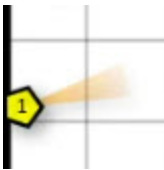

- A gray cone extending from the Camera Device indicates the camera was previously active on a camera shot. The direction the cone is facing is the direction the camera's lens is facing.

#### Inactive Camera Shot Indicator

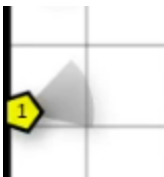

AutoSwitch Preview provides the capability to fine-tune Virtual Mic locations within the room layout. Adjust Virtual Mic locations so that they are accurate to the audio positions that AutoSwitch Preview is providing.

For optimal performance, perform an AutoSwitch Preview test on each Virtual Mic position. This determines whether the associated microphone is accurately detecting the Virtual Mic position. Verify the following items on each Virtual Mic position with AutoSwitch Preview:

1. Confirm the Virtual Mic is in range of the Microphone Device. The line extending from the Microphone Device should be a solid line (not a dashed line) when interacting with the Virtual Mic position.
2. Ensure that the **Noise Delay** threshold is being met on the Virtual Mic position as desired. For more information about Noise Delay, refer to [AutoSwitch Settings on page 108](#).
3. Confirm that Camera Devices and their **Shot Width** match the Virtual Mic position. For more information on configuring Camera Devices for Virtual Mic positions, refer to [Cameras on page 84](#)

Once the Virtual Mic positions are verified with AutoSwitch Preview, select the **Stop AutoSwitch** in the top left of Room Designer to exit AutoSwitch Preview.

# Configuration

Refer to the following sections for information on how to configure Automate VX:

- [System Configuration](#)
- [Scenario Setup Tool](#)
- [Wirecast Configuration](#)
- [DSP Configuration](#)

# System Configuration

Automate VX can be configured using its web configuration interface as described in the sections that follow.

**NOTE:** Most system configurations can be accomplished by using the [Intelligent Video Room Designer tool](#). This tool is available on the Crestron website and locally on the Automate VX. For more information on using the tool, refer to [Room Designer on page 32](#).

## Access the Web Configuration Interface

To access the web configuration interface for the Automate VX, open the browser on Automate VX. The web configuration interface loads automatically.

To access the web configuration interface from a different device:

1. Enter the IP address of the Automate VX system with port 3579 appended to the address (for example, "10.1.10.31:3579")

A login page is displayed.

### Login Page

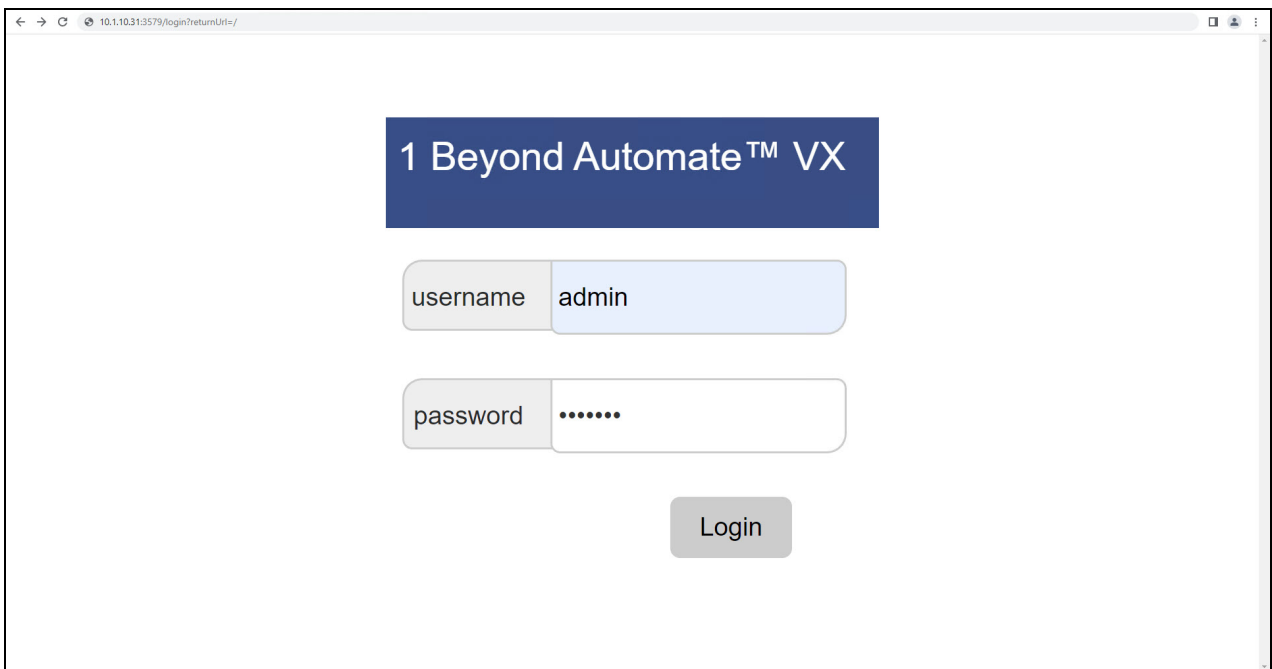

The screenshot shows a web browser window with the address bar containing "10.1.10.31:3579/login?returnUrl=/". The main content area displays a login form. At the top, there is a dark blue banner with the text "1 Beyond Automate™ VX". Below this, there are two input fields. The first is labeled "username" and contains the text "admin". The second is labeled "password" and contains masked characters ".....". Below the password field is a "Login" button.

2. Enter the following login credentials:

- **username:** admin
- **password:** 1beyond

3. Select **Login**.

**NOTE:** The login credentials above are for the admin user only. If additional users are added to the system, use their respective login credentials to access the system. For more information, refer to [Add User on page 122](#).

The web configuration interface is displayed with the **Main** settings by default.

**NOTE:** The **Main** settings are also where the operation of the Automate VX occurs. For more information on how to use the **Main** settings for the operation of the Automate VX, refer to [Operation on page 181](#).

Web Configuration Interface - Main Tab

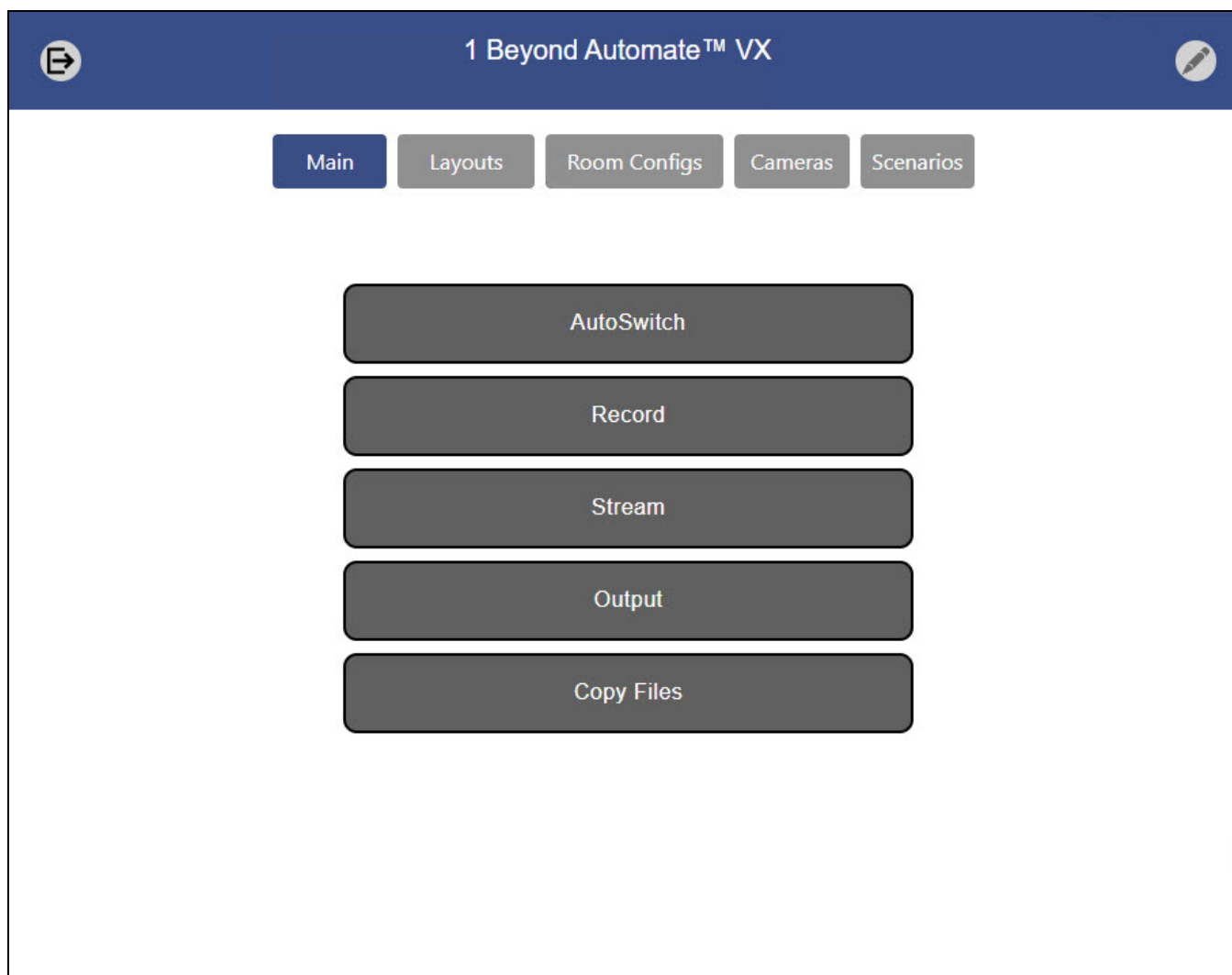

To access the system settings:

1. Select the pencil icon on the top right of the page to open Room Designer.

#### Main Settings to Room Designer

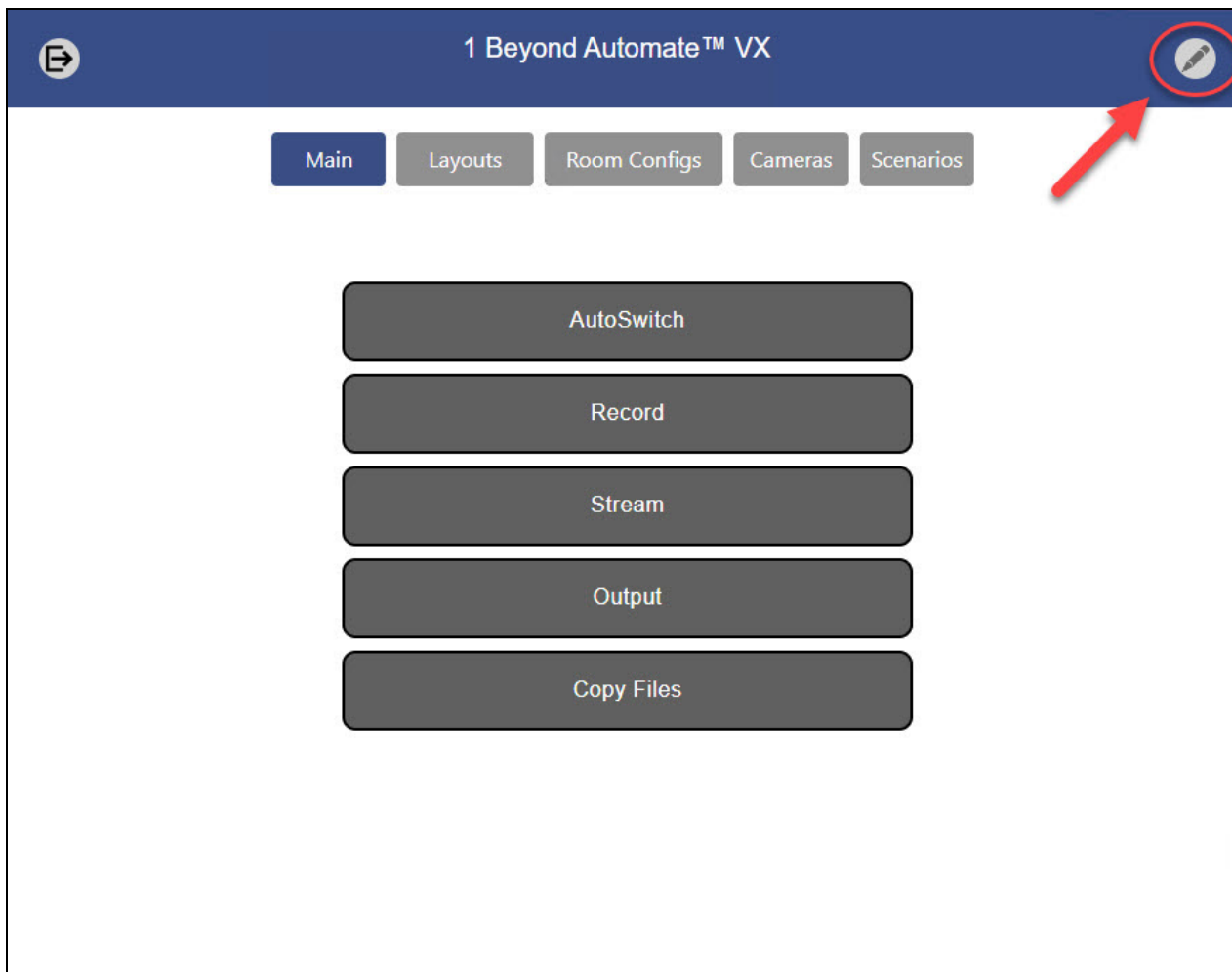

2. Select the gear icon at the top right of the page to open the system settings.

### Room Designer Page

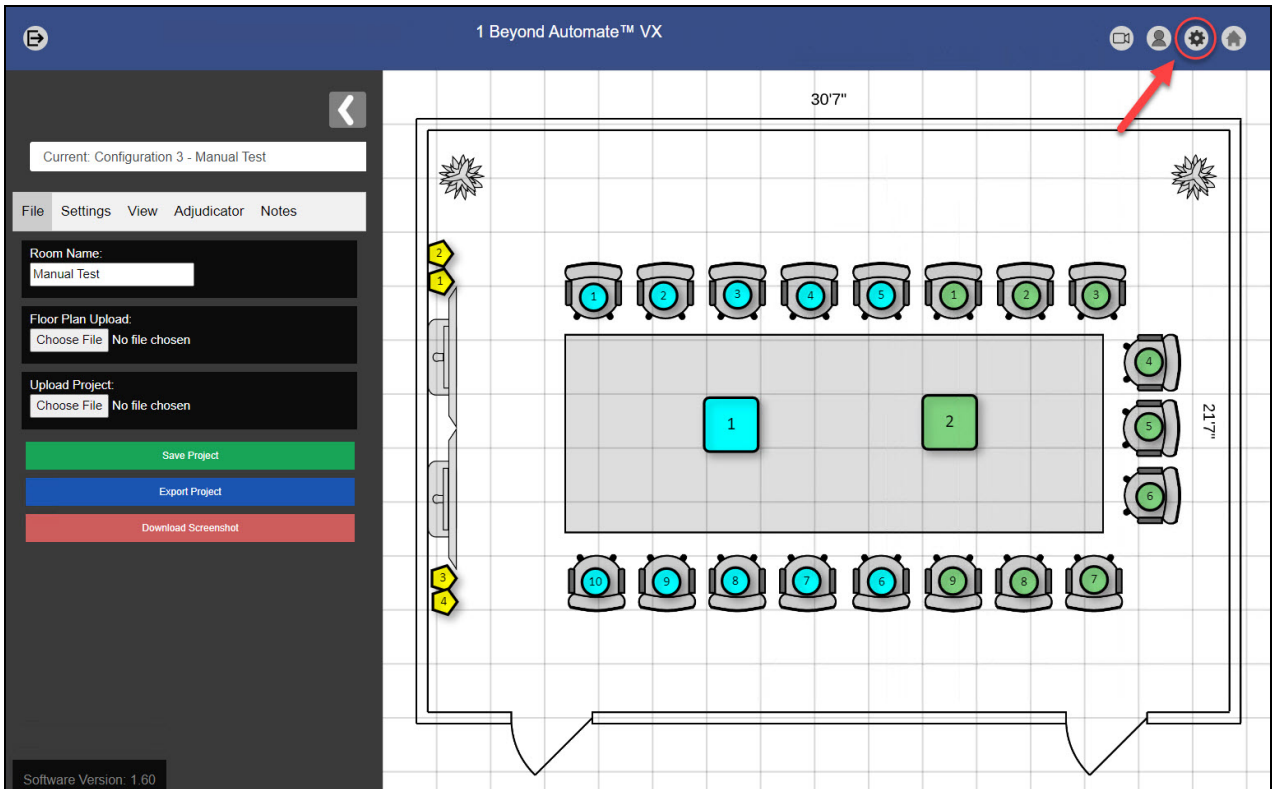

When trying to access the system settings anywhere else besides the **Main** settings, the gear icon is present.

## General Settings

Select the **General** tab to view the available general system settings.

### General Tab

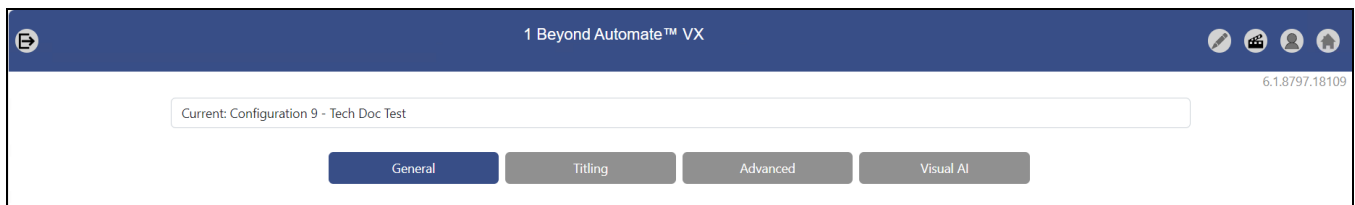

The following general system settings can be configured.



## Output Settings

The following settings are used to turn the available camera outputs on and off, and to select the desired resolution for each output.

### Output Settings

Current: Configuration 2 - Boardroom 2 Cameras

General Titing Advanced

Output Settings

SDI 1080p30

NDI 1080p30

Virtual Camera HD 1080p (1920x1080)

Three output settings are provided that can be turned on or off: **SDI**, **NDI**, and **Virtual Camera**.

Each output has a drop-down menu with the following resolution output options:

- NTSC
- PAL
- 1080i 50
- 1080i 59.94
- 1080i 60
- 1080p 23.98
- 1080p 24
- 1080p 25
- 1080p 29.97
- 1080p 30
- 1080p 50
- 1080p 59.94
- 1080p 60
- 720p 50
- 720p 59.94
- 720p 60

## Layout Settings

Layouts are a way of switching between different composite shots. Composite shots are camera shots with multiple video layers.

### Layout Settings

Layout Settings (Currently Selected: A)

ID	Layout Name
A	Full Screen
B	Dynamic Q&A
C	PiP

Add Layout Remove Layout

Each layout is given an ID (A to Z) and can be named by selecting the appropriate **Layout Name** text field.

- To add additional layouts, select **Add Layout**. A new layout is added with the next available letter ID.
- To remove layouts, select **Remove Layout**. The last available layout is removed (for example, if Layouts A-D are configured, Layout D will be removed).

**NOTE:** Removing a layout will always remove the most recent layout. However, it will still exist within Wirecast. If a layout was accidentally deleted in the web UI, simply add a layout that corresponds with the deleted ID to restore the layout.

Layouts are configured through Wirecast. For more information, refer to [Wirecast Configuration on page 132](#).

## Record Settings

The following recording settings are provided.

### Record Settings

Record Settings

Enable ISO Recording

Enable Pause

Select the **Enable ISO Recording** check box to save a separate ISO recording of each camera input into the system in addition to the program recording. An ISO recording captures individual camera feeds and stores the output of the feeds.

For more information on starting and stopping recording through the web configuration interface, refer to [Operation on page 181](#).

Select the **Enabling Pause** check box to provide pausing functionality during recording. Pausing will create incomplete recordings which are stored in **D:/Recording\_Temp**. Once a recording has been stopped, the incomplete recordings are joined into a complete recording and saved in **D:/Recordings**.

## Sleep and Wake Settings

The following sleep and wake settings are provided.

### Sleep and Wake Settings

Sleep and Wake Settings	
Wake Action	Cameras Forward
Sleep Action	Cameras Back
Startup Action	Wake
Autoswitch Off	No Action

Open the **Wake Action** drop-down menu to select the following camera actions when the camera wakes from sleep mode:

- Cameras Forward
- Start AutoSwitch
- Start AutoSwitch and AutoTrack
- Any Scenarios that have been created

**NOTE:** For more information on AutoSwitch and AutoTrack, refer to [Main Menu on page 181](#)

Open the **Sleep Action** drop-down menu to select the following camera actions when entering sleep mode:

- Cameras Back
- Any Scenarios that have been created

Open the **Startup Action** drop-down menu to select the following camera actions upon boot-up of the system:

- Wake
- Sleep

Open the **Autoswitch Off** drop-down menu to select the following camera actions when Autoswitching has been disabled:

- No Action
- Any Scenarios that have been created

**NOTE:** Automate VX reboots daily to better the performance of the system. The system will perform the action selected for **Startup Action** upon reinitialization.

## Push-to-Talk Settings

The following push-to-talk settings are provided.

### Push-to-Talk Settings

**Push-to-Talk Settings**

Enable Side by Side

Side by Side Threshold  ms

Select the **Enable Side by Side** check box to turn on side-by-side shots. A side-by-side shot is a split screen shot that captures two active participants who are speaking intermittently for a short time frame. This shot will be called after the system detects that two active participants have been speaking for longer than the time set for the **Side by Side Threshold**. For discussion systems, the side-by-side shot will show the two most recent participants who have pressed their unmute button.

**NOTE:** To move to the next queued speaking participant in a discussion system, one of the two active speaking participants in the side-by-side shot must turn on their mute button. If another participant is waiting in the speaking queue, they will enter the side-by-side shot when one of the two active speaking participants turns on their mute button.

Use the **Side by Side Threshold** text field to determine how long two active participants need to be speaking before the side-by-side shot is called.

**Conversation Mode Settings**

Enable Conversation Mode

Conversation Length  s

Select the **Enable Conversation Mode** check box to turn on conversational side-by-side shots. A conversational side-by-side shot is a split screen shot that captures two active participants who are speaking.

This shot will be called after the system detects another speaking participant other than the current one, and will place them on a side-by-shot for the duration set in the **Conversation Length** field. Once the duration set for **Conversation Length** is exceeded, the camera shot will transition to a single shot of the last active speaking participant.

## AutoSwitch Settings

The following AutoSwitch settings are provided.

### Auto Switch Settings

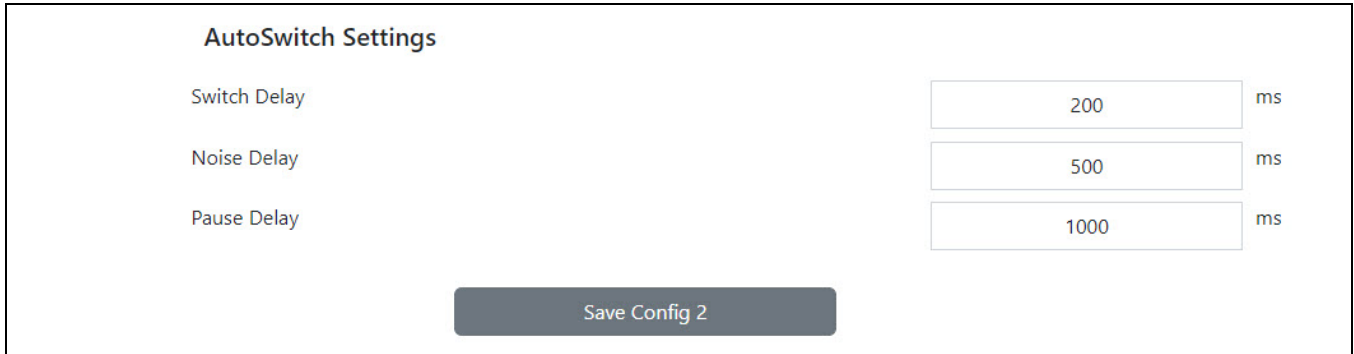

AutoSwitch Settings	
Switch Delay	200 ms
Noise Delay	500 ms
Pause Delay	1000 ms

Save Config 2

- **Switch Delay:** Determines how long it will take the system to switch to a camera shot. Increasing this value will help prevent camera movement during AutoSwitching.
- **Noise Delay:** Determines how long a noise needs to occur before the system recognizes it. This feature helps to avoid switching based on coughs or other short sounds.
- **Pause Delay:** Determines how long after an active participant stops speaking before the camera will switch to another camera or a default shot.

## Titling Settings

Select the **Titling** tab from the settings page to view the available titling settings.

### Titling Tab

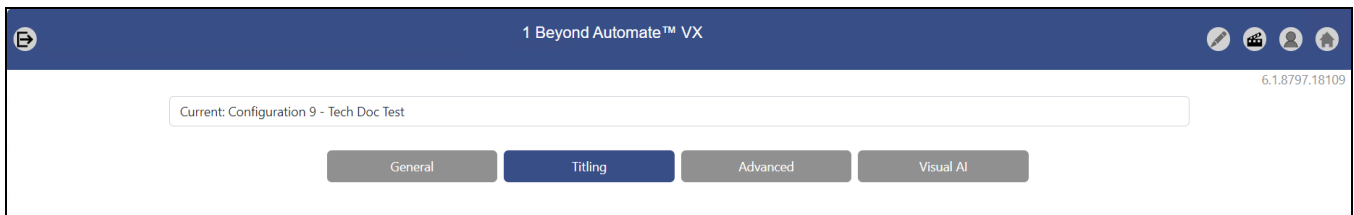

1 Beyond Automate™ VX

Current: Configuration 9 - Tech Doc Test

6.1.8797.18109

General Titling Advanced Visual AI

The following titling settings can be configured.

## Microphone Table

The **Microphone Table** shows the relationship between microphone devices and virtual microphones in the system. The **Device Number** column indicates the microphone device and the **Mic Number** column shows the virtual microphone associated with the microphone device.

### Microphone Table

Device Number	Mic Number	
1	1	
1	2	
1	3	
1	4	
1	5	
1	6	
1	7	
1	8	
1	9	
1	10	
1	11	
1	12	
1	13	
1	14	
1	15	

Microphone Devices are configured through Room Designer. For more information, refer to [Microphone Device Configuration on page 67](#).

## Title Settings

The following titling settings are available.

### Title Settings

### Title Settings

Enable Titling

Static Titling from Mic. Table  
 Dynamic Titling from Mic. Devices  
 Setup Titling from Dev./Mic. Number

Save Config 2

Selecting the check box next to the **Enable Titling** setting will allow one of the following three selections to be available:

- Select **Static Titling from Settings** to add a third column to the **Microphone Table** for entering titles manually.

#### Microphone Table - Static Title Column

Device Number	Mic Number	Static Title
1	1	Seat 1
1	2	Seat 2
1	3	Seat 3
1	4	Seat 4
1	5	Seat 5

- Select **Dynamic Titling from Mic. Devices** to dynamically pull titles from a discussion system.
- Select **Setup Titling from Dev/Mic. Number** for use during system configuration. The active device and corresponding microphone numbers will be displayed to verify that the correct device and microphone are being used.

Use the **Default Shot Title** field to change the name of the default shot.

## Advanced Settings

Select the **Advanced** tab to view the available advanced settings.

#### Advanced Tab

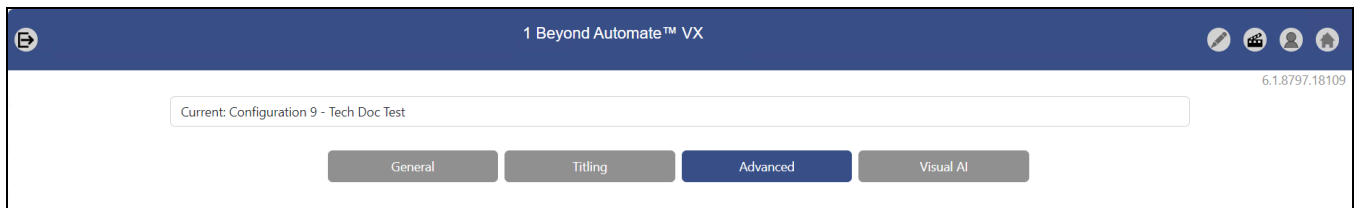

The following advanced settings can be configured.

### Room Configurations

The **Room Configurations** setting allows for different microphones and room furniture arrangements to be used. This is especially helpful within divisible and multipurpose rooms.

Each room configuration saves a separate copy of all the settings in the Automate VX.

## Room Configuration Settings

Room Configuration	
ID	Config Name
1	Default
2	Manual Test
3	Upstairs

[Add Config](#) [Remove Current Config](#)

Each layout is given an ID number and corresponds to the associated configuration name.

- To add additional configurations, select **Add Config**. A new configuration will be added with the next available numbered ID.
- To remove the active configuration, select **Remove Current Config**. The active configuration is indicated by the drop-down menu on the top of the settings menu. This will remove it from the Automate VX and Room Designer.

**NOTE:** Ensure that projects are saved within Room Designer and exported to a local drive before removing configurations. If a configuration is unintentionally removed and needs to be restored, contact [Crestron True Blue Support](#).

Changing a configuration name must be done within Room Designer. For more information, refer to [Room Designer on page 32](#).

Selecting a room configuration can also be called with an API or Crestron command. For more information on using the Automate VX API, refer to the appropriate documentation at <https://developer.crestron.com>.



## Load Microphone Device Preset

When using multiple room configurations, it is possible to load corresponding presets for Shure Intellimix Devices such as MXA910, MXA310, P300, and Intellimix Room. This is useful when multiple room and lobe layouts are used.

### Load Microphone Device Presets

Load Mic Device Preset for Room Config 2

Enable on changing to this room configuration

Device #	IP	Model
1	1.2.3.4	MXA

Add Device Remove Device

Select the **Enable on changing to this room configuration** check box to load the corresponding numbered microphone array preset when the room configuration is changed.

- Select **Add Device** to add a microphone array. A new microphone array will be added with the next available device number.  
Select **Remove Device** to remove a microphone array. The last available microphone array is removed (for example, if microphone arrays 1-4 are configured, microphone array 4 will be removed).
- Use the **IP** field to enter the IP address of the microphone array.
- Use the **Model** drop-down menu to select the correct device for the microphone array.

## Copy Files Settings

The following file copying settings are provided.

### Copy Files Settings

Copy Files Settings

Destination: D:\Destination\VX

Log Dest.: D:\Destination\VX\Log

Delete files from source after copying

By default, all recordings are saved to local storage of the Automate VX at **D:\Recordings\VX**. The **Copy Files** button on the home page copies these files to the specified destination when selected. For more information, refer to [Operation on page 181](#).

The **Destination** path can be set to a mapped network location, a full network address, or an external drive. A log of the copy will be created at the location set for **Log Dest.**

Select the **Delete files from source after copying** check box to remove files from **D:\Recordings\VX** after a successful copy. When unchecked, copied files are moved to **D:\RecordingsDone**.

## Video Production Server Settings

The following video production settings are provided.

### Video Production Server Settings

**Video Production Server Settings**

Enable Wirecast

Enable ATEM

- Select the **Enable Wirecast** check box to enable communication between the Automate VX system and Wirecast.
- Select the **Enable ATEM** check box to use Blackmagic® Design ATEM switchers with the Automate VX system.

**NOTE:** Both **Enable Wirecast** and **Enable ATEM** can be enabled at the same time.

## Reboot System

Select the **Reboot** button to restart Automate VX.

**Reboot System**

## Save VX Logs

Automate VX can create and save logs of the data that it outputs.

### Save VX Logs

**Save VX Logs**

Destination

Enter a file path into the **Destination** text field to save log files to this location. Click **Download Logs** to create a file with the logs in the specified destination path.

# Visual AI

Select the **Visual AI** tab to view the available Visual AI settings.

## Visual AI Tab

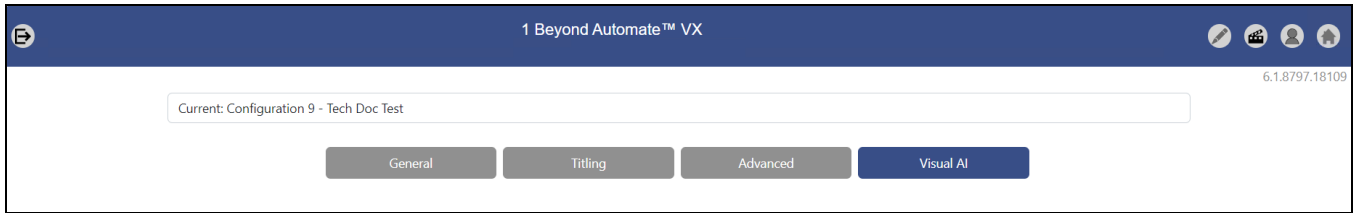

The following **Visual AI** settings can be configured.

## Autoframing Settings

Autoframing and Reframing enables Automate VX to automatically frame optimal camera shots on Virtual Mic positions. Automate VX detects faces at the Virtual Mic location that is activated, and frames the camera shot so that the speaking participant is centered. Refer to the following sections for information on the available Autoframing and Reframing settings.

**NOTE:** Autoframing Settings is only available for the p12 (IV-CAM-P12) , p20 (IV-CAM-P20), PTZ-IP 12 (IV-CAMP12), and PTZ-IP 20 (IV-CAMP20) cameras. i12 (IV-CAM-I12-B), i20 (IV-CAM-I20), and AutoTracker 3 (IV-CAMA3-20) cameras must be set to **Use as PTZ** for Autoframing Settings to apply. For more information on cameras, refer to [Camera Device Configuration on page 59](#).

## Autoframing Settings

General Titling Advanced **Visual AI**

### Autoframing Settings

Enable Autoframing

Frame Padding  ⓘ

Max Shot Width  ⓘ

Face Offset  ⓘ

Number of People  ⓘ

Enable True Position ⓘ

Enable Reframing

Reframing Sensitivity: Medium



## Enable Autoframing

Select the **Enable Autoframing** check box to turn on Autoframing. Autoframing enables cameras to center participants in the camera shot when a Virtual Mic is activated. If the participant moves from the position, the camera will not follow and attempt to keep the participant centered in the camera shot. For more information on Virtual Mics, refer to [Virtual Mic and Blocking Zone Configuration on page 78](#).

### Enable Autoframing

<p><b>Autoframing Settings</b></p> <p><input checked="" type="checkbox"/> Enable Autoframing</p>
--

## Advanced Autoframing Settings

The following settings are available to adjust the Autoframing behavior of Automate VX. Use the camera shot preview graphic on the bottom of the Visual AI page for an approximation of the Autoframing camera shot.

**NOTE:** In most cases, the default settings provided give the optimal Autoframing and Reframing performance. Change the following settings only if it required to do so.

## Advanced Autoframing Settings

### Autoframing Settings

- Enable Autoframing
  - Frame Padding  ⓘ
  - Max Shot Width  ⓘ
  - Face Offset  ⓘ
  - Number of People  ⓘ
- Enable True Position ⓘ

## Camera Shot Preview



### Frame Padding

Use the up and down arrows in the **Frame Padding** field to adjust the space around the participant in the Autoframed camera shot.

### Max Shot Width

Use the up and down arrows in the **Max Shot** Width field to adjust the how far the Autoframed camera shot can zoom out.

## Face Offset

Use the up and down arrows in the **Face Offset** field to adjust where the Autoframed camera shot places the head of the participant.

## Number of People

Use the up and down arrows in the **Number of People** field to determine the number of people included in AutoFraming.

## Enable True Position

Select the **Enable True Position** check box to turn on True Position. True Position takes the information from the intelligent array microphone and determines the location of the audio source. The Autoframed camera shot then focuses on the location determined by True Position.

## Enable Reframing

Select the **Enable Reframing** check box to turn on Reframing. Reframing keeps the speaking participant in the center of the camera shot, even when the participant moves from their initial position.

The camera shot preview displays red edges around the participant, indicating the space where Reframing will occur when the participant enters it.

### Enable Reframing

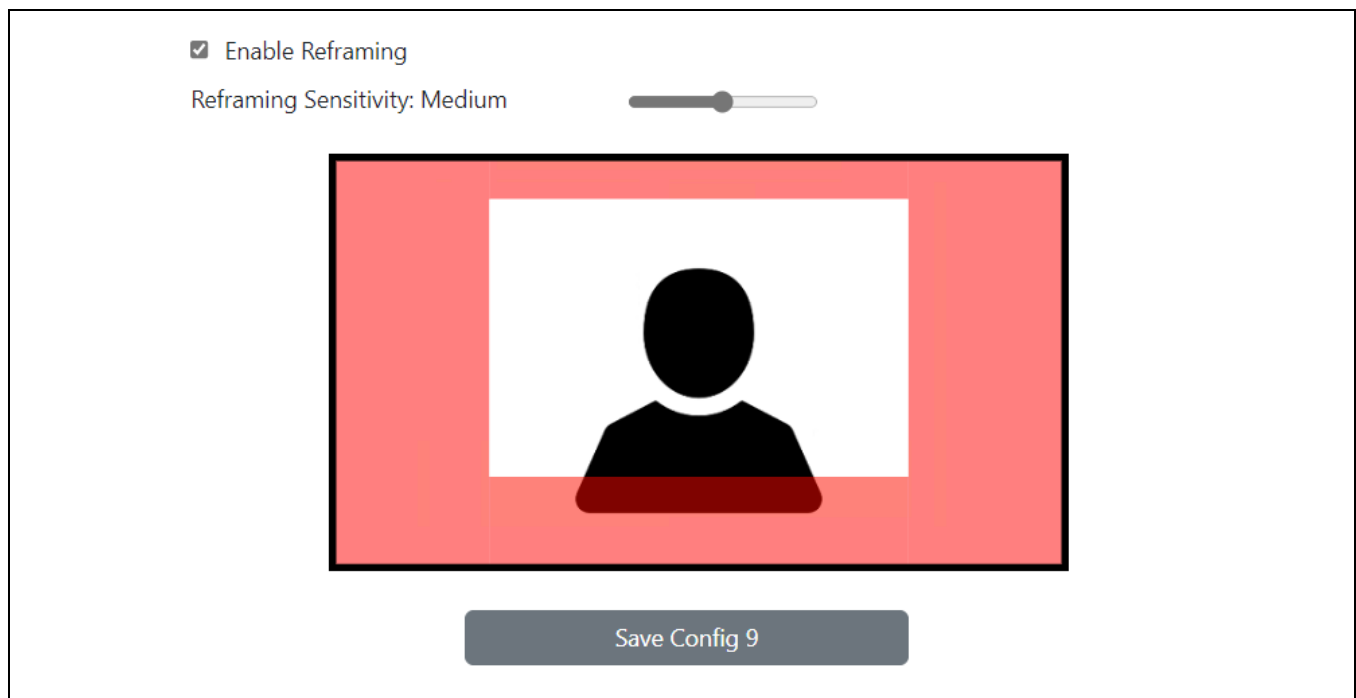

Automate VX continues to keep the camera shot centered on the participant until another speaking participant triggers a different Virtual Mic position, or if the Default Shot timeout duration is met. For more information about Default Shots, refer to [Add Default Shot on page 44](#).

## Reframing Sensitivity

Use the **Reframing Sensitivity** slider to adjust the space on the edges of the camera shot where Reframing occurs. **Low**, **Medium**, and **High** sensitivities are available. The higher the **Reframing Sensitivity** is set, the more often Reframing will occur when the subject moves in the camera shot.

### Reframing Sensitivity

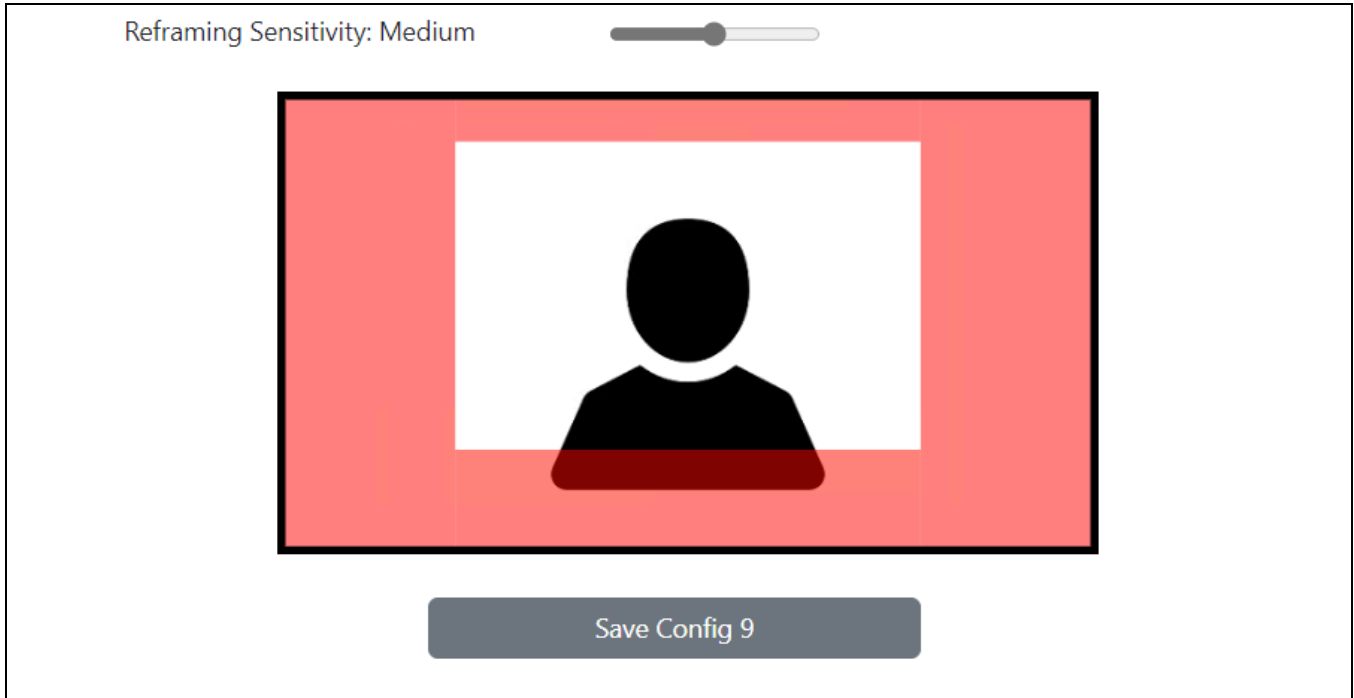



# Admin and User Settings

Admin and User settings are accessible by selecting the **Users** icon at the top right of the page while logged in as an admin.

## Users Icon

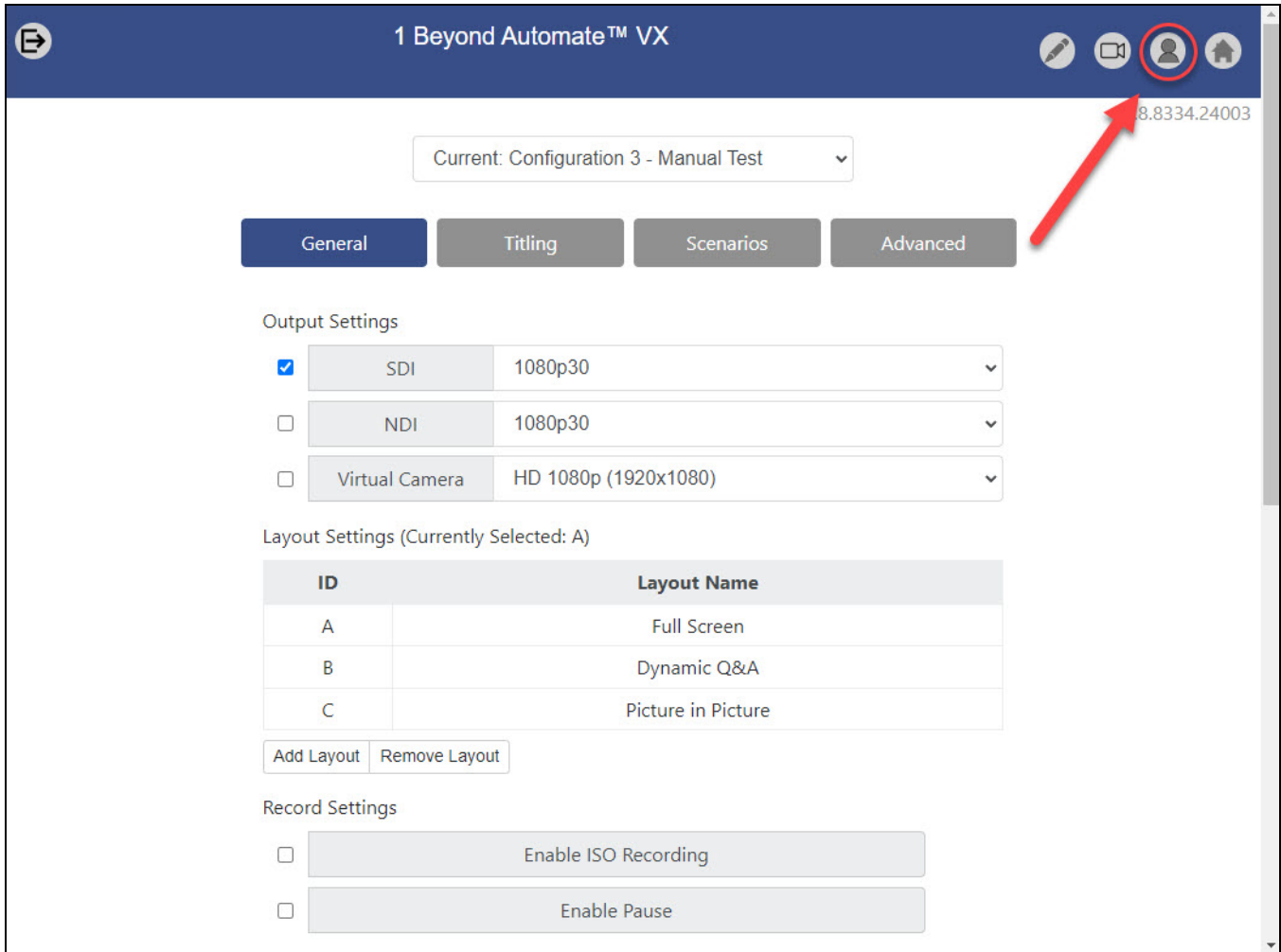

The admin user has full access to all settings. New users can be created with full or limited access to system settings.

## Permissions

Select the **Permissions** tab to set permissions for additional users in the system. For example, an end user could be given permission only to operate the AutoSwitch feature. Additional users will need to be created using the **Add User** settings to change permissions for other users. For more information, refer to [Add User on page 122](#).

### User Settings - Permissions

Permissions Add User Change Password Delete User

Username  
admin

Permission	Enable
Main Tab Buttons	
AutoSwitch	<input checked="" type="checkbox"/>
Record	<input checked="" type="checkbox"/>
Stream	<input checked="" type="checkbox"/>
Output	<input checked="" type="checkbox"/>
Copy Files	<input checked="" type="checkbox"/>
Home Page Tabs	
Layouts	<input checked="" type="checkbox"/>
Room Configs	<input checked="" type="checkbox"/>
Cameras	<input checked="" type="checkbox"/>
Scenarios	<input checked="" type="checkbox"/>
Navigation Icons	
Settings	<input type="checkbox"/>
User Admin	<input type="checkbox"/>
Designer	<input type="checkbox"/>
Setup	<input checked="" type="checkbox"/>

Update Permissions

Select a user from the **Username** drop-down menu to change permissions for that user.

**NOTE:** The admin user will always have full permissions.

Select the check box next to a setting under the **Enable** column to allow the user to access that setting. Unselect the check box to remove the setting for that user.

Select **Update Permissions** to save any changes.

## Add User

The following settings to add a user are provided.

### User Settings - Add User

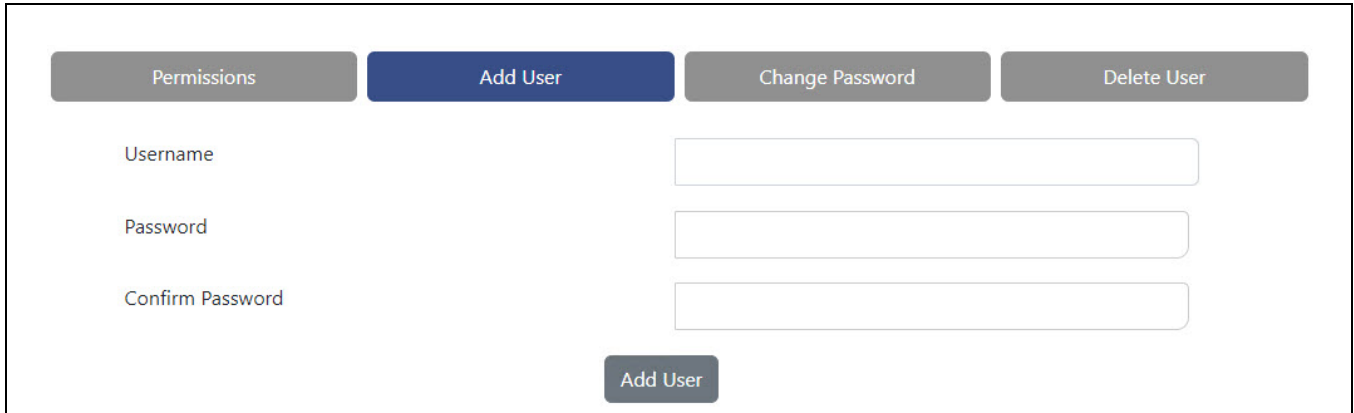

The screenshot shows the 'Add User' tab selected. At the top, there are four tabs: 'Permissions', 'Add User' (highlighted in blue), 'Change Password', and 'Delete User'. Below the tabs, there are three text input fields labeled 'Username', 'Password', and 'Confirm Password'. At the bottom center, there is a blue 'Add User' button.

Select the **Add User** tab to add a new user.

Enter the new username and password in the appropriate text fields, then select **Add User**.

## Change Password

Select the **Change Password** tab to update the password for an existing user.

### User Settings - Change Password

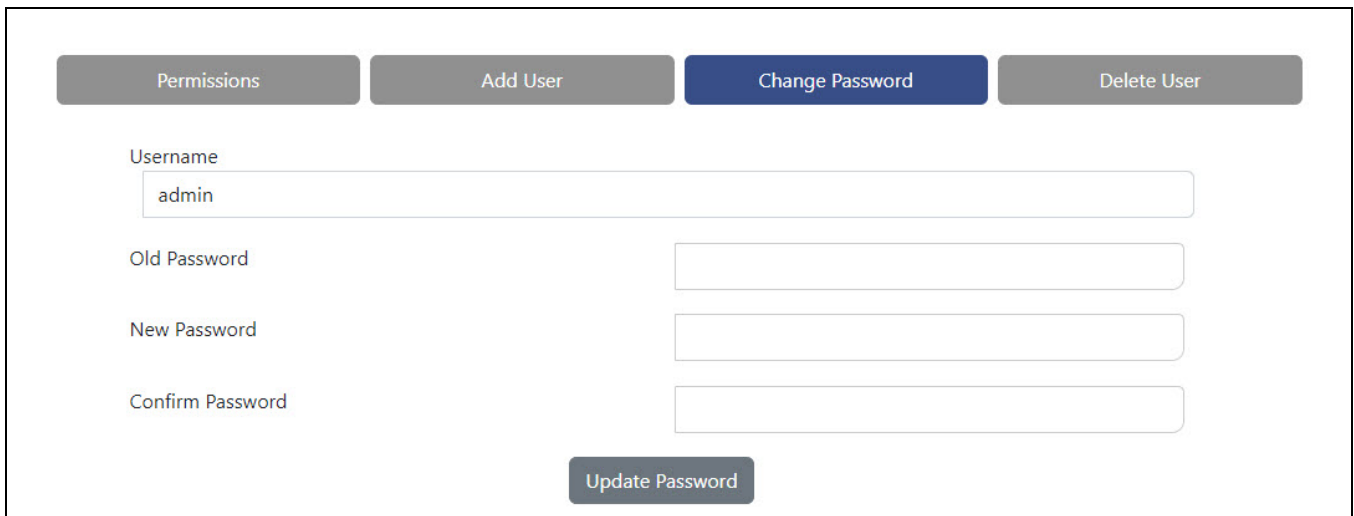

The screenshot shows the 'Change Password' tab selected. At the top, there are four tabs: 'Permissions', 'Add User', 'Change Password' (highlighted in blue), and 'Delete User'. Below the tabs, there are four text input fields. The first is labeled 'Username' and contains the text 'admin'. The other three are labeled 'Old Password', 'New Password', and 'Confirm Password'. At the bottom center, there is a blue 'Update Password' button.

1. Select the user from the **Username** drop-down menu.
2. Enter the existing password in the **Old Password** text field.
3. Enter the new password in the **New Password** and **Confirm Password** text fields.
4. Select **Update Password**.

## Delete User

The following settings to delete a user are provided.

### User Settings - Delete User

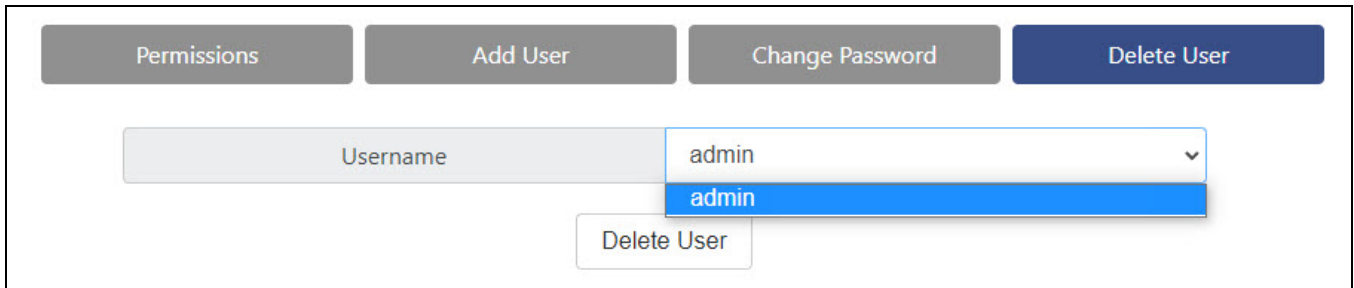

The screenshot shows a user management interface with four tabs: 'Permissions', 'Add User', 'Change Password', and 'Delete User'. The 'Delete User' tab is selected and highlighted in dark blue. Below the tabs is a 'Username' input field containing the text 'admin'. A dropdown menu is open below the input field, showing a list with 'admin' selected and highlighted in blue. Below the dropdown is a 'Delete User' button.

Select the **Delete User** tab to delete an existing user.

Enter the username of the user to delete, then select **Delete User**.

# Scenario Setup Tool

Automate VX contains the **Scenario Setup** tool that provides customizable Scenarios. Scenarios are a series of actions that Automate VX can perform when paired with cameras, such as selecting a room configuration, enabling AutoSwitching, and selecting a layout with a single button.

Scenarios can also be used to define the sleep and wake actions of Automate VX. For more information, refer to [Sleep and Wake Settings on page 106](#).

To access the **Scenario Setup** tool, select the clapperboard icon within Room Designer. For more information on Room Designer, refer to [Room Designer on page 32](#).

## Clapperboard Icon Selection

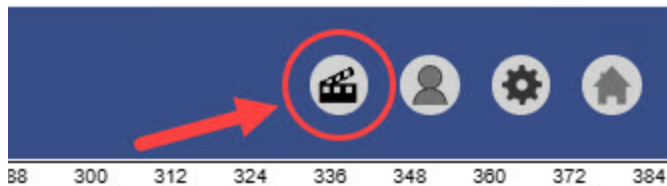

The **Scenario Setup** page is displayed.

## Scenario Setup Page

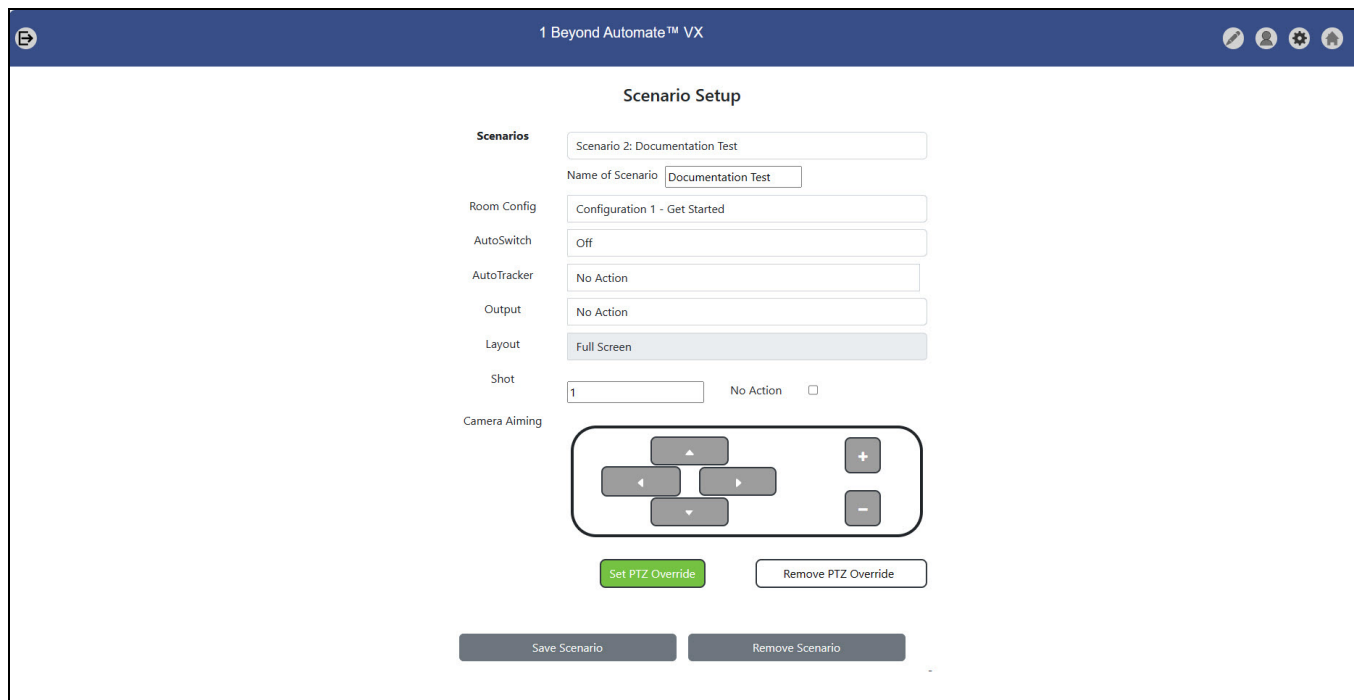

The following settings are provided for configuring a Scenario.

# Scenario Selection

Use the **Scenarios** drop-down menu to change the Scenario or to create a new Scenario.

## Scenario Selection Menu

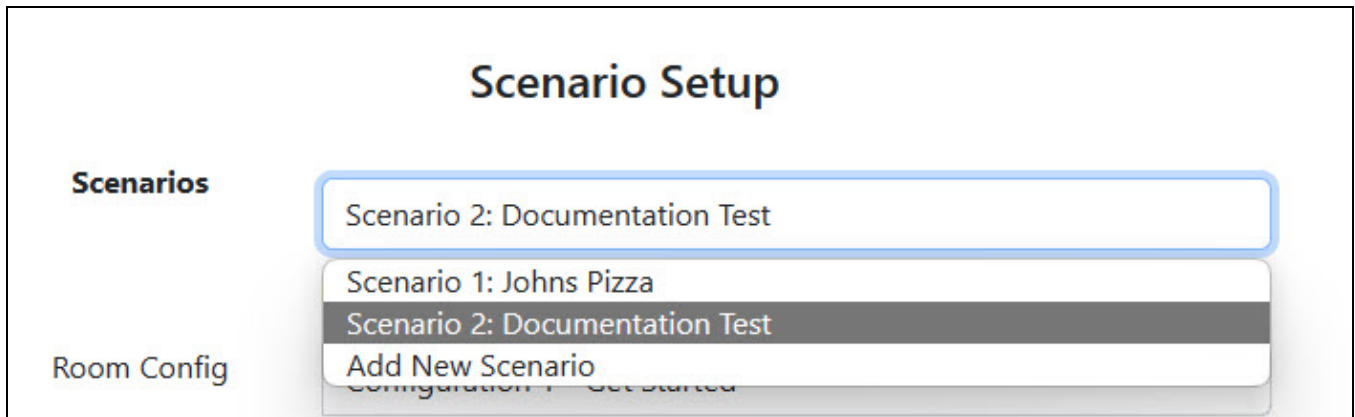

The following options are available:

- Select the respective **Scenario** to configure the settings for it.
- Select **Add New Scenario** to create a new Scenario. Added Scenarios are assigned numbers in ascending order.

Use the **Name of Scenario** text field to change the name of the selected Scenario.

## Name of Scenario Text Field

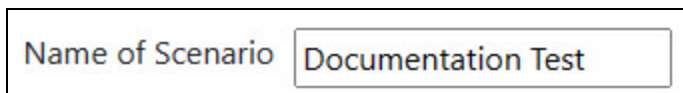

# Room Configuration Selection

Use the **Room Config** drop-down menu to select the room configuration to be used with the Scenario. For more information on room configurations, refer to [Room Configurations on page 110](#).

## Room Configuration Selection Menu

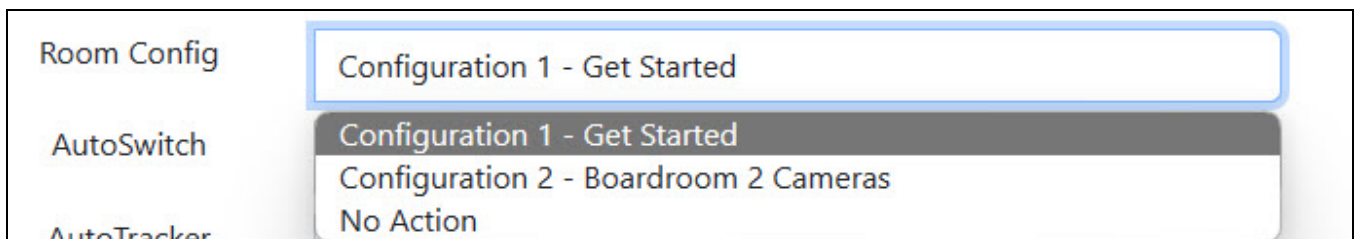

The following options are available:

- Select the desired room configuration to switch to when the Scenario is activated.
- Select **No Action** to maintain the room configuration used before the Scenario is activated.

# AutoSwitch Action

Use the **AutoSwitch** drop-down menu to define the AutoSwitching behavior of the Scenario. For more information on AutoSwitching, refer to [Main Menu on page 181](#).

## AutoSwitching Action Menu



The following options are available:

- Select **On** to enable AutoSwitching when the Scenario is activated.
  - This also activates the **Layout** selection drop-down menu in the Scenario. For more information on **Layout** selection, refer to [Layout Selection on page 128](#).
- Select **Off** to disable AutoSwitching when the Scenario is activated.
  - This also activates the **Shot** text field in the Scenario. For more information on the Wirecast shot layer text field, refer to [Shot Selection on page 128](#)
- Select **No Action** to maintain the current AutoSwitching status when the Scenario is activated.

**NOTE:** **AutoSwitch** restarts if the Scenario has **On** or **No Action** selected as the **AutoSwitch** Action. A sudden camera cut to the recent active Virtual Mic may occur. For more information on Virtual Mics, refer to [Virtual Mic Settings on page 82](#).

# AutoTracking Action

Use the **AutoTracker** drop-down menu to define the AutoTracking (presenter tracking) behavior of AutoTracker 3 cameras in the Scenario. For more information about AutoTracker 3 cameras in a room configuration, refer to [Configuring Camera Devices](#).

## AutoTracking Action



The following **AutoTracker** indicators are shown:

- The numbered buttons on the right side of the **AutoTracker** drop-down menu represent which cameras in the room configuration are AutoTracker 3 cameras. In the image above, camera 8 in the room configuration is an AutoTracker 3 camera.
- When two or more AutoTracker 3 cameras are present, additional buttons appear to the right of the **AutoTracker** drop-down menu, indicating multiple AutoTracker 3 cameras are available.

- A green outline appears around the numbered camera button when selected, indicating that the camera is receiving the AutoTracking action.
  - There is no green outline present if the AutoTracker 3 camera is not selected.
- If there are no AutoTracker 3 cameras available in the room configuration, then the area to the right of the **AutoTracker** drop-down menu remains empty.

Complete the following procedure to change the AutoTracking action of the camera:

1. Select the desired numbered camera button icon on the right side of the **AutoTracker** menu.
2. Open the **AutoTracker** drop-down menu to define the selected camera's presenter tracking behavior in the Scenario.

#### AutoTracking Action Menu

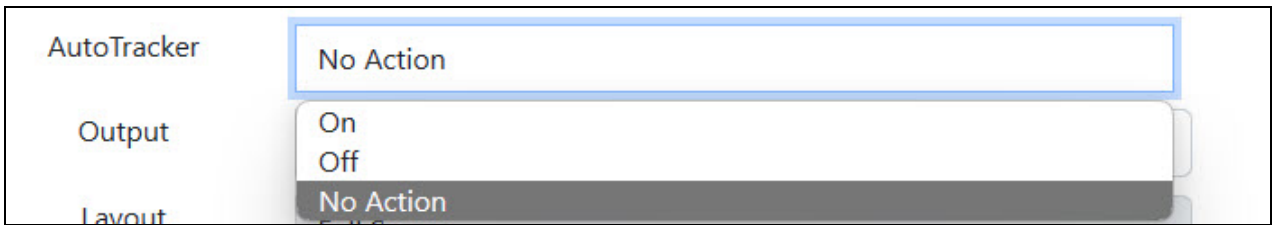

The following options are available:

- Select **On** to enable presenter tracking on the camera when the Scenario is activated.
- Select **Off** to disable presenter tracking on the camera when the Scenario is activated.
- Select **No Action** to maintain the current presenter tracking status on the camera when the Scenario is activated.

**NOTE:** If the current presenter tracking mode on the camera is the same as the **AutoTracker** action set for the Scenario, then the camera mode is not changed when the Scenario is activated.

The presenter tracking status on the camera is now set. Perform the procedure above for each camera in the Scenario.



# Output Action

Use the **Output** drop-down menu to define the Automate VX video output status of the Scenario. For more information on Automate VX video output, refer to [Main Menu on page 181](#).

## Output Action Menu

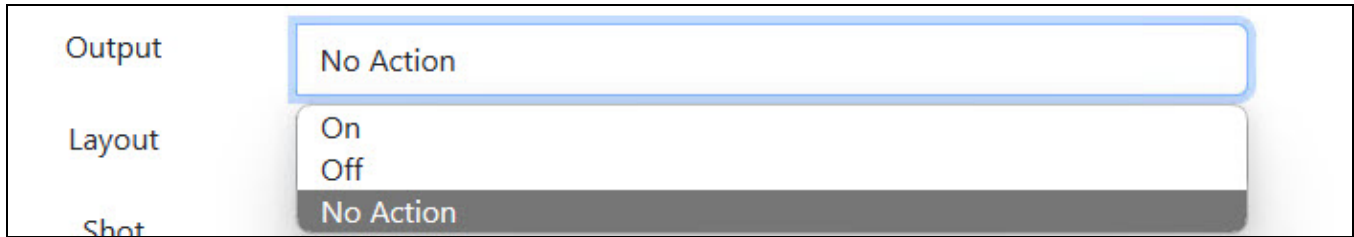

The following options are available:

- Select **On** to enable Automate VX video output when the Scenario is activated.
- Select **Off** to disable Automate VX video output when the Scenario is activated.
- Select **No Action** to maintain the current Automate VX video output status when the Scenario is activated.

**NOTE:** If the current Automate VX video output status matches the **Output** action of the Scenario, then the video output is not affected.

# Layout Selection

Use the **Layout** drop-down menu to select the Wirecast® layout to be used with the Scenario. For more information on layouts, refer to [Layouts Menu on page 183](#).

## Layout Selection



**NOTE:** This option is only available if **AutoSwitch** is enabled for the Scenario. For more information on how to enable **AutoSwitch** in the Scenario, refer to [AutoSwitch Action on page 126](#)

# Shot Selection

Use the **Shot** selection options to set a Wirecast shot layer as the Automate VX output. For more information on Wirecast shot layers, refer to [Wirecast Configuration on page 132](#).

**NOTE:** This option is only available if **AutoSwitch** is disabled for the Scenario. For more information on how to disable **AutoSwitch** in the Scenario, refer to [AutoSwitch Action on page 126](#)

## Wirecast Layout Text Field

Shot	<input type="text" value="Scenario 1"/>	No Action	<input type="checkbox"/>
------	---	-----------	--------------------------

The following options are available:

- Input the Wirecast shot layer into the **Shot** text field to switch to a specific Wirecast shot layer when the Scenario is activated.

**NOTE:** The **Shot** text field must match the Wirecast shot layer exactly. If the **Shot** text field does not match the Wirecast shot layer, Automate VX displays an error when activating the Scenario. For example, if Wirecast shot layer **A\_Cam 1** is the desired camera shot for the Scenario, **A\_Cam 1** must be entered into the **Shot** text field.

- Select the **No Action** checkbox to keep the current camera shot active when the Scenario is activated.

## Camera Aiming

**Camera Aiming** allows for manual control over the pan, tilt, and zoom of camera shots in the Scenario.

### Camera Aiming Controls

Camera Aiming

1 2 3 4 5 6 7

▲

◀ ▶

▼

+

-

Set PTZ Override

Remove PTZ Override

Complete the following procedure to create a PTZ Override for the Scenario:

1. Use the **Camera Aiming** numbered buttons to select the camera that is going to receive the PTZ Override. Each numbered button corresponds to the respective camera in the room configuration. A green outline appears around the numbered camera button when selected.

**Camera Selection**



2. Use the arrow buttons to move the camera shot in the desired direction.

**Arrow Buttons**

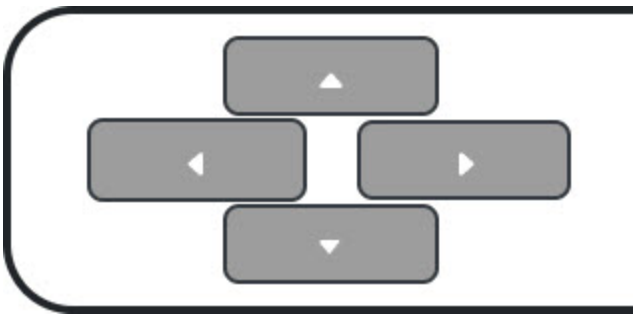

3. Use the plus and minus buttons to zoom the camera in (+) or zoom the camera out (-).

**Zoom Buttons**

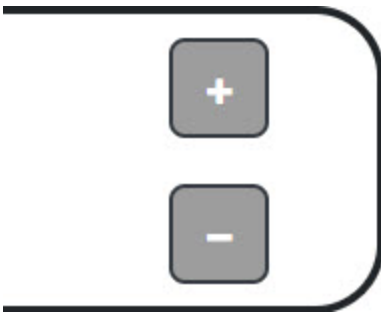

4. After the desired shot for the scenario is made, select **Set PTZ Override** to save the camera shot in the scenario.

**NOTE:** Select **Remove PTZ Override** to remove any PTZ Overrides associated with the camera. This only affects the current scenario.

The camera now has a PTZ Override for the Scenario. Perform the procedure above for each camera that is receiving a PTZ Override in the scenario.

# Save And Remove Scenario

Select **Save Scenario** to save all settings configured for the current Scenario. Select **Remove Scenario** to delete the current Scenario.

## Save and Remove Scenario



# Wirecast Configuration

Automate VX uses Wirecast® streaming software to change live shots, layouts, and output.

During initial setup, changes may need to be made to the Wirecast document to customize the system, such as setting custom layouts with logos. The Wirecast document is located within **C:\Program Files\1 Beyond\Automate Project.wcst**.

**NOTE:** The Wirecast document uses a specific naming convention for shots that must be followed for the Automate VX to function properly. These naming conventions are described in the sections that follow.

The project provides basic shots for a layout A, including side-by-side shots, as well as a layout B with an alternative appearance.

## Configure Basic Shots

A basic shot is labeled with the input number and the layout it is associated with (for example, **A\_Cam 1**, **A\_Cam 2**, **A\_Cam 3**, **B\_Cam 1**, **B\_Cam 2**, **B\_Cam 3**, and so forth).

**NOTE:** The naming convention above must be used for the Automate VX to function properly.

### Basic Wirecast Shots



If using less than three inputs on the IV-SAM-VXS-1B or less than seven inputs on the IV-SAM-VXP-1B, any unused basic shots can be removed by right-clicking the shot and then selecting **Delete Shot**.

## Create Side-by-Side Shots

When side-by-side shots are turned on, two active speaking participants are shown simultaneously. The labeling convention for side-by-side shots is similar to basic shots with the second camera added to the end (for example, **A\_Cam 1\_2**, **A\_Cam 1\_3**, **A\_Cam 2\_3**, and so forth).

**NOTE:** Not every camera permutation is required, and the lower camera number will always be used first. For example, **A\_Cam 1\_2** is used, but **A\_Cam 2\_1** is not.

## Side-by-Side Wirecast Shots



When creating side-by-side shots in the Wirecast document, place the first camera on the left and the second camera on the right.

## Add Titles

Titles are placed in shots in the layer above the basic and side-by-side shots. Each layout has a regular title and a side-by-side title (for example, **A\_Title** and **A\_Title\_S**).

### Wirecast Titles



Wirecast is able to display text in title based on a text file. To ensure titles are displayed correctly, regular titles must reference **titles.txt** (in **C:\Program Files\1 Beyond\Automate VX\**), and side-by-side titles must reference **titles.txt** for the left shot and **titles2.txt** for the right shot.

Images, shapes, and other elements can be added to titles. For more information, refer to the [Wirecast documentation](#).

## Create Layouts

Layouts are labeled by letter (A through Z). This labeling convention applies to basic shots, side-by-side shots, and titles (for example, layout B would use **B\_Cam 1**, **B\_Cam 1\_2**, **B\_Title**, and **B\_Title\_S**).

### Wirecast Layouts



**NOTE:** If side-by-side shots are turned on, side-by-side shots must be configured in every layout that will use these shots.

## Configure Audio

Audio input to the Automate VX is not required for voice-activated camera switching. For video conferencing, send audio directly from your DSP to your codec with a 400ms delay in order to ensure proper lip sync.

For local recording or streaming with the system, activate the installed Dante Virtual Soundcard by purchasing a license from [www.audinate.com](http://www.audinate.com). Alternatively, use the line in input on the system rear panel for an analog signal flow.

# DSP Configuration

Automate VX can utilize a DSP to route audio logic from microphones for AutoSwitching. For more information about AutoSwitching, refer to [Main Menu on page 181](#). The Adjudicator settings in Room Designer must be configured along with the DSP. For more information about the Adjudication settings inside of Room Designer, refer to [Adjudicator Settings](#).

Refer to the following sections for information on how to configure the respective DSP for Automate VX:

- [Shure Intellimix® Room and P300 Configuration for Automate VX](#)
- [Biamp Tesira™ Configuration for Automate VX](#)
- [QSC Q-SYS™ Core Configuration for Automate VX](#)



# Shure Intellimix® Room and P300 Configuration for Automate VX

The following items are required to integrate a Shure Intellimix® DSP with Automate VX:

- IV-SAM-VXS-1B, IV-SAM-VXP-1B, or IV-SAM-VXN-1B.
- A computer with the latest version of Shure Intellimix® Room Audio Processing software.
- (Optional) A Shure IntelliMix® P300 Audio Conferencing Processor.

Before configuring the Shure Intellimix DSP to communicate with Automate VX, complete the following procedure to open the Shure Intellimix® project file:

1. Open Shure Intellimix Room Audio Processing software on a computer. Ensure that it is the newest version of the software.
2. Select **File** in the top left corner of the software.
3. Select **Open**, then select the project for the room that is going to be used with Automate VX.

## Command Strings

Command strings must be enabled for Shure Intellimix to communicate with Automate VX. To enable command strings:

1. Double click with the left mouse button on the DSP device in the project.
2. Select the gear icon on the top right of the software.

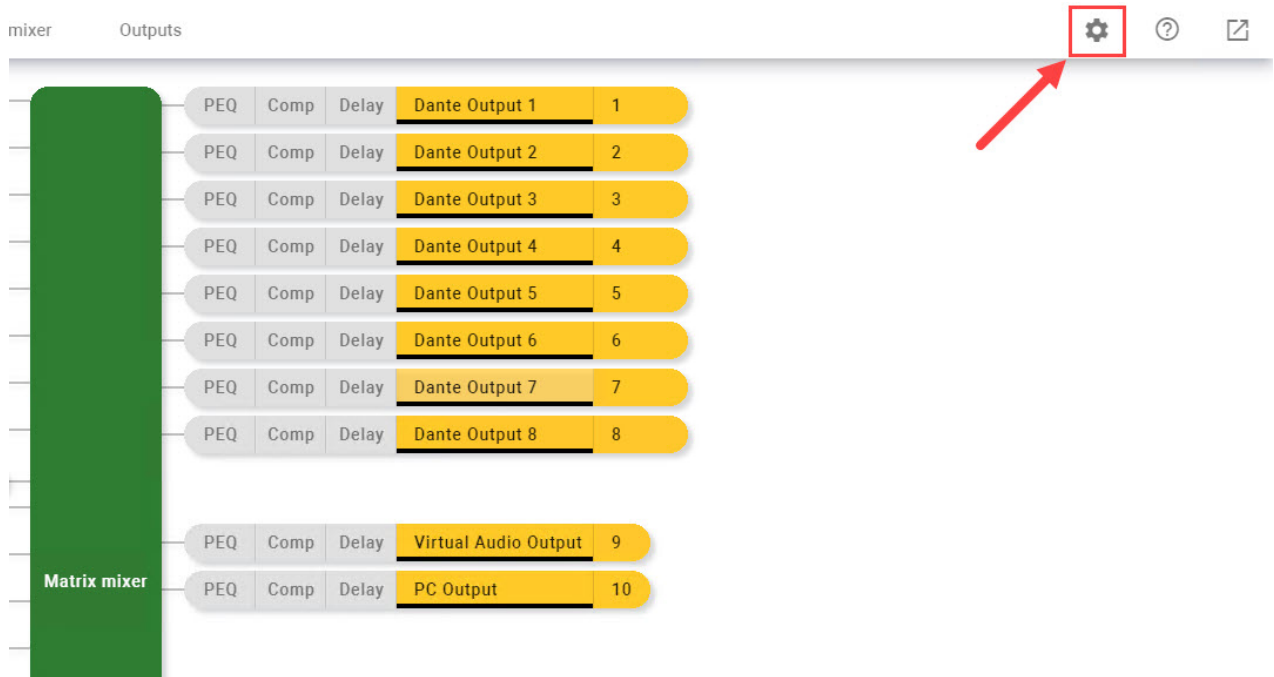

3. Select the **Command strings** option under the **Security** header.

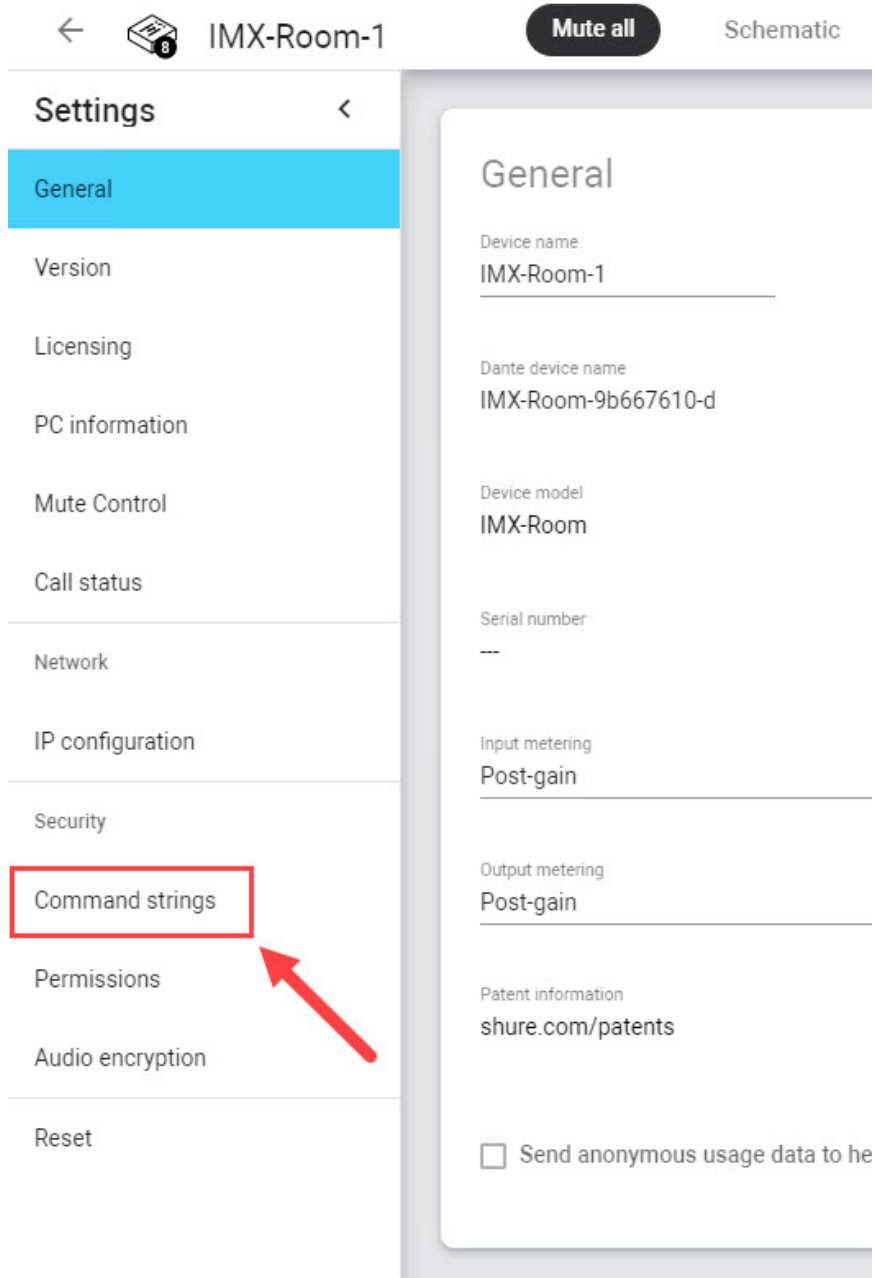

4. Enable **Command strings** by selecting the **Command strings:** switch to **On**.

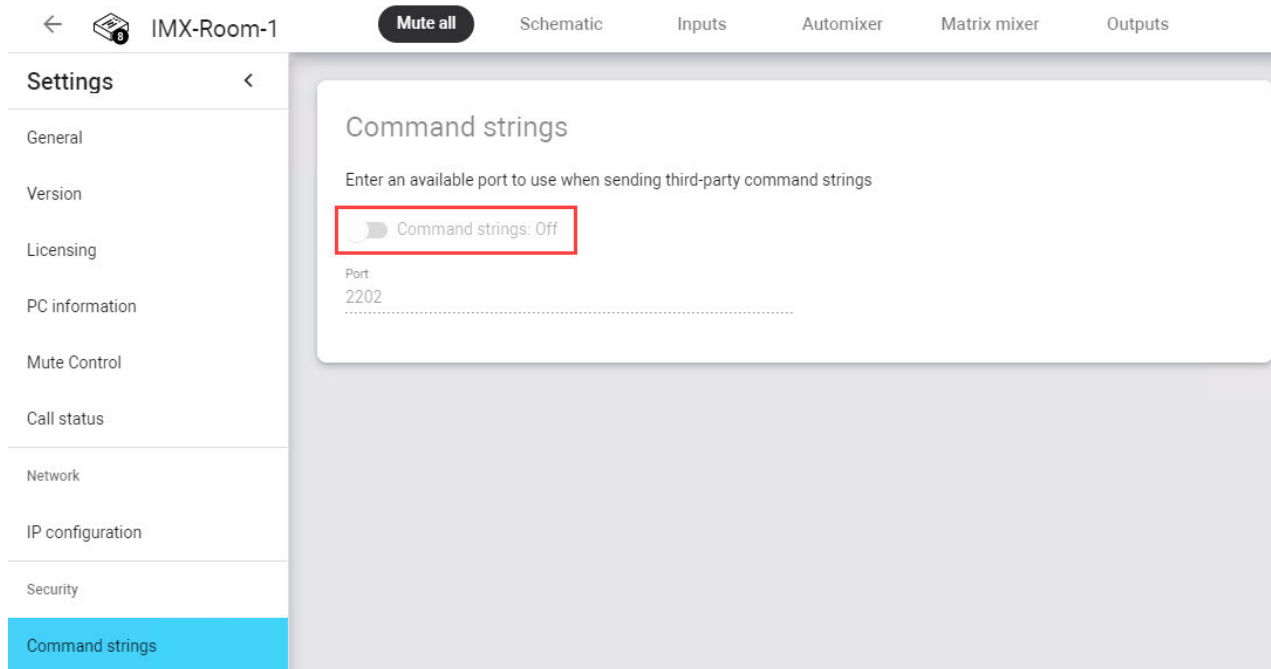

## Automixer Settings

Automixer settings in Shure Intellimix provide a better control of AutoSwitching behavior with Automate VX. For more information about AutoSwitching, refer to [Main Menu on page 181](#).

To change the **Automixer** settings:

1. Select **Automixer** on the top toolbar. This opens the **Automixer** menu.

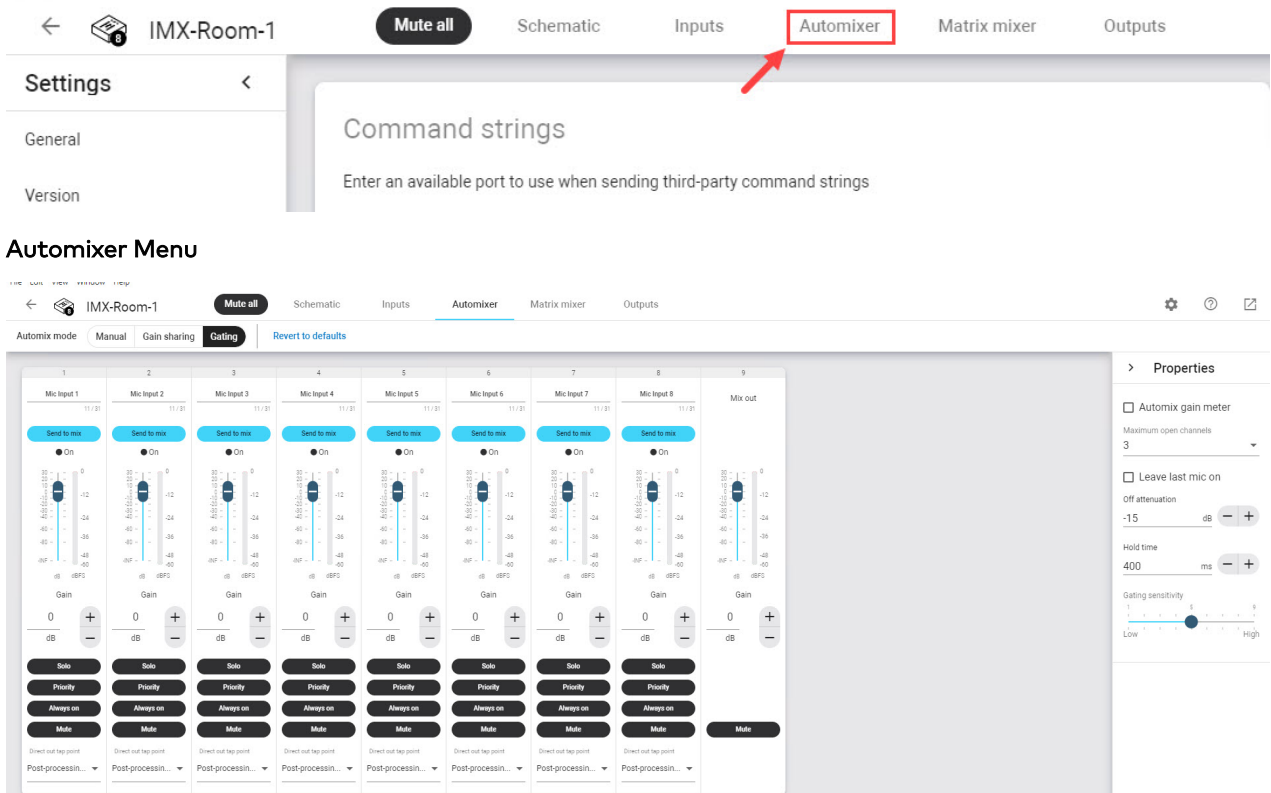

- In the **Properties** menu, select the **Leave last mic on** check box to disable the setting.

### Leave last mic on Disabled

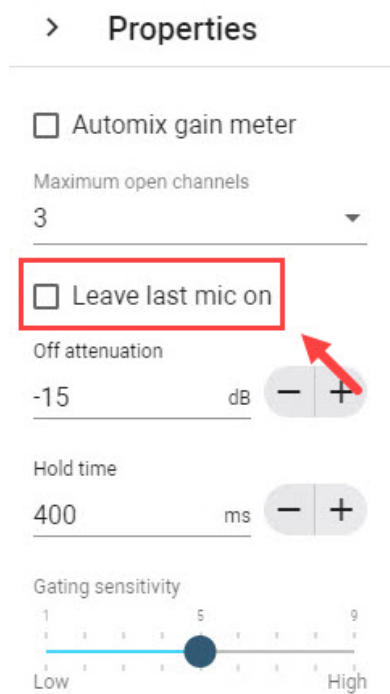

- Use the **Maximum open channels** drop-down menu to set the limit of open mics to 2 or 3 depending on the number of channels.

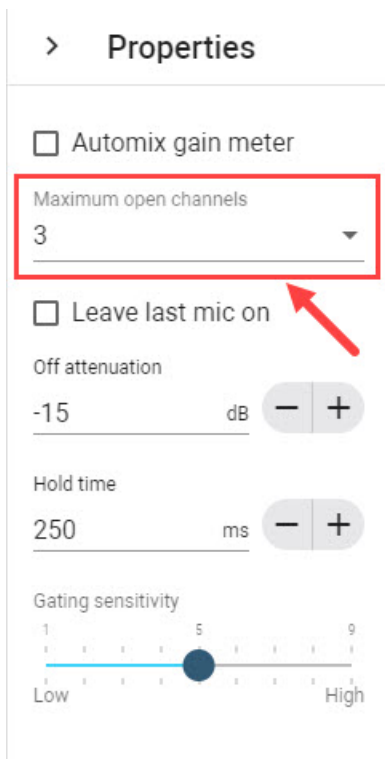

- Input 250 into the **Hold time** text field. A 250 ms hold time ensures that the audio syncs with the Automate VX video feed.

**NOTE:** If NDI cameras are used with Automate VX, the **Hold time** may need to be increased to 300 ms. This is due to the added latency over the network. Test the video output from Automate VX with this value and adjust the delay accordingly to sync the audio and video.

> **Properties**

Automix gain meter

Maximum open channels  
3

Leave last mic on

Off attenuation  
-15 dB

**Hold time**  
250 ms

Gating sensitivity  
1 5 High  
Low

# Biamp Tesira™ Configuration for Automate VX

The following items are required to integrate a Biamp Tesira™ DSP with Automate VX:

- IV-SAM-VXS-1B, IV-SAM-VXP-1B, or IV-SAM-VXN-1B.
- Biamp TesiraFORTÉ™ or Biamp Tesira SERVER™.
- A computer with the latest version of Tesira Design software.

Before configuring the Biamp Tesira DSP to communicate with Automate VX, complete the following procedure to open the Tesira Design project file:

1. Open Tesira Design software on a computer. Ensure that it is the newest version of the software.
2. Select **File** in the top left corner of the software.
3. Select **Open**, then select the project for the room that is going to be used with Automate VX.

## Gating Mixer

A dedicated gating mixer is required in the Tesira project for Automate VX to communicate with the DSP. To add and configure a gating mixer to the Tesira Design project file:

1. On the Object Toolbar, select the **Mixers** button  to open the drop-down menu.

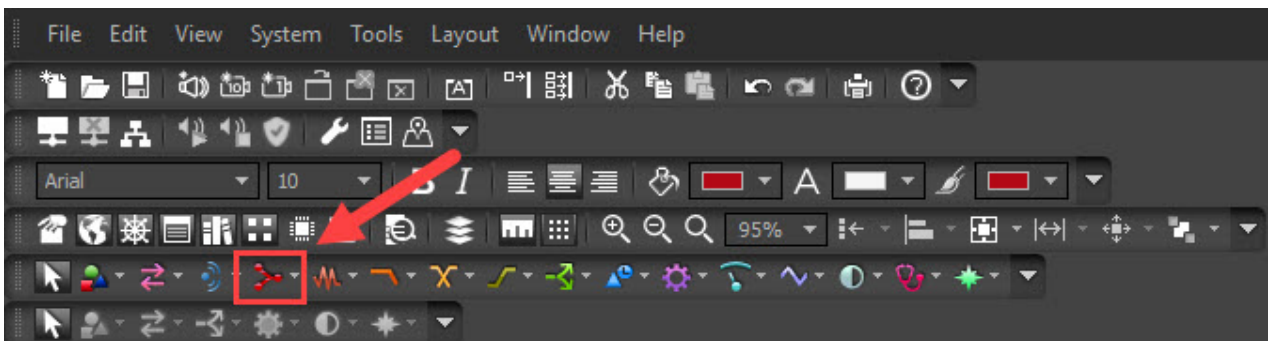



2. Select **Gating Auto Mixer**, then click the left mouse button inside the project to add the **Gating Auto Mixer** block. The **Gating Auto Mixer** block appears in the project.

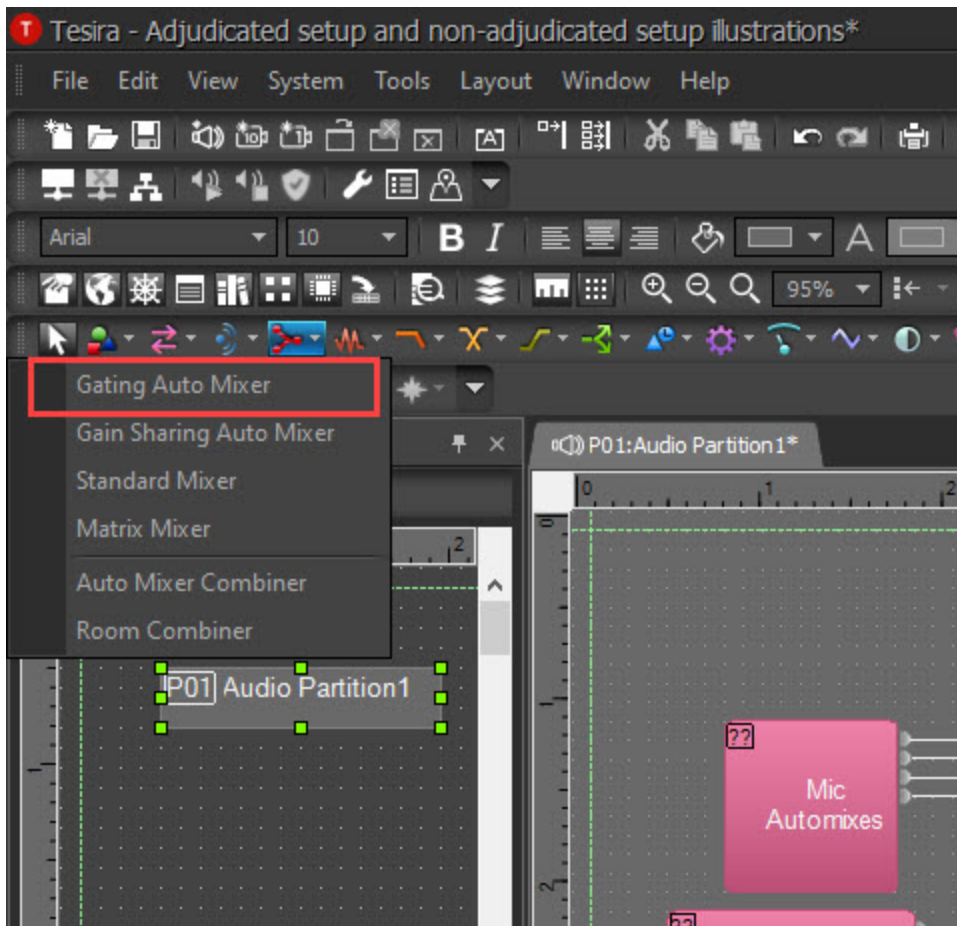

Gating Auto Mixer Block

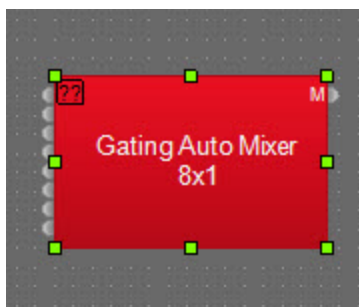

3. In the **Input Channel Count** drop-down menu, select the same number of channels used in the AutoSwitching configuration. For more information about channels in Automate VX, refer to [Configuring Adjudicators on page 90](#).

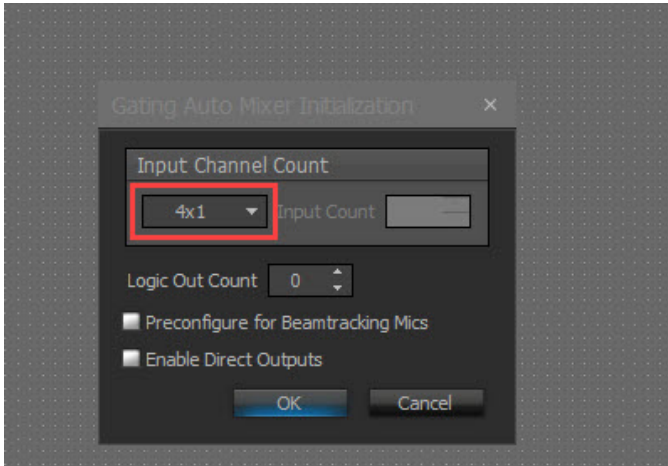

## NOTES:

- The **Gating Auto Mixer** is a separate, but parallel gating mixer to the one used for audio processing.
- The audio is routed into the gating mixer after AEC and room mutes, but before other audio processing (EQ, compression, and so forth).

## Gating Auto Mixer in Project

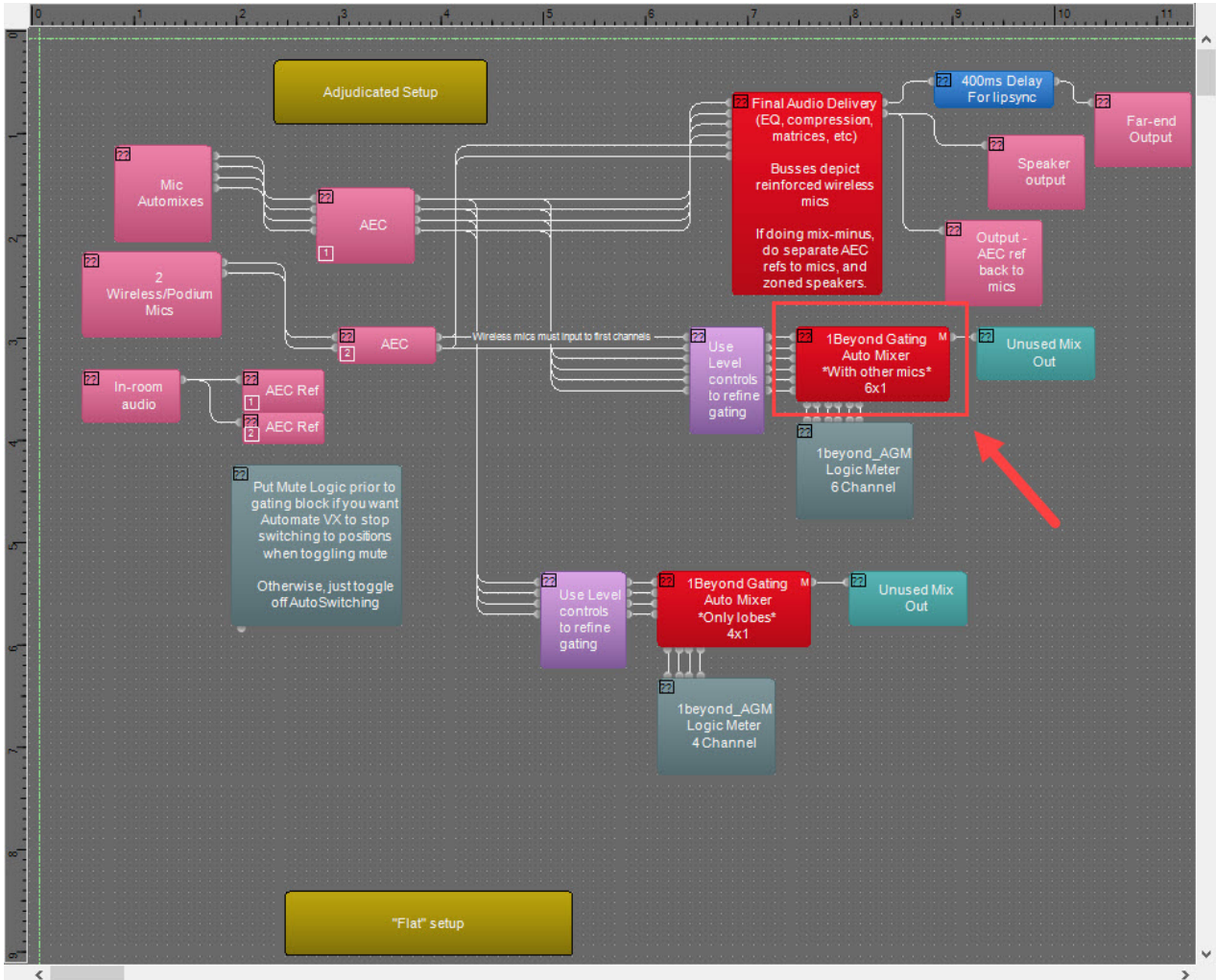

- Place a connection on the output of the gating mixer. Use a **Signal Presenter Meter** if uncertain which connection should be made.

**NOTE:** The Tesira code will not compile without placing a connection on the output.

### Output Connection Example

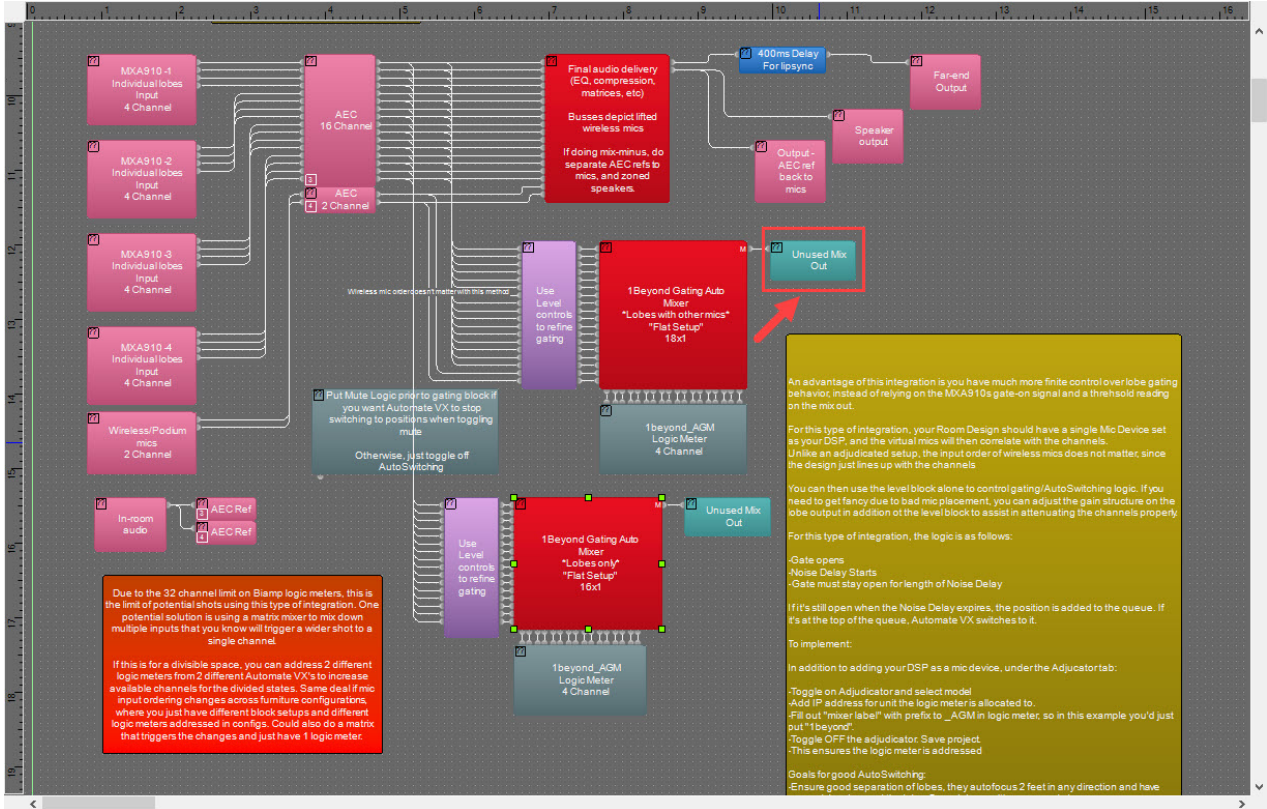

### Open Mic Limits

Setting the limit of open microphones at a given time provides a better AutoSwitching experience with Automate VX. For more information about AutoSwitching, refer to [Main Menu on page 181](#).

Complete the following procedure to configure the microphone settings of the gating mixer block:

1. Double-click the left mouse button on the **Gating Auto Mixer** block to open the Gating Auto Mixer settings window.

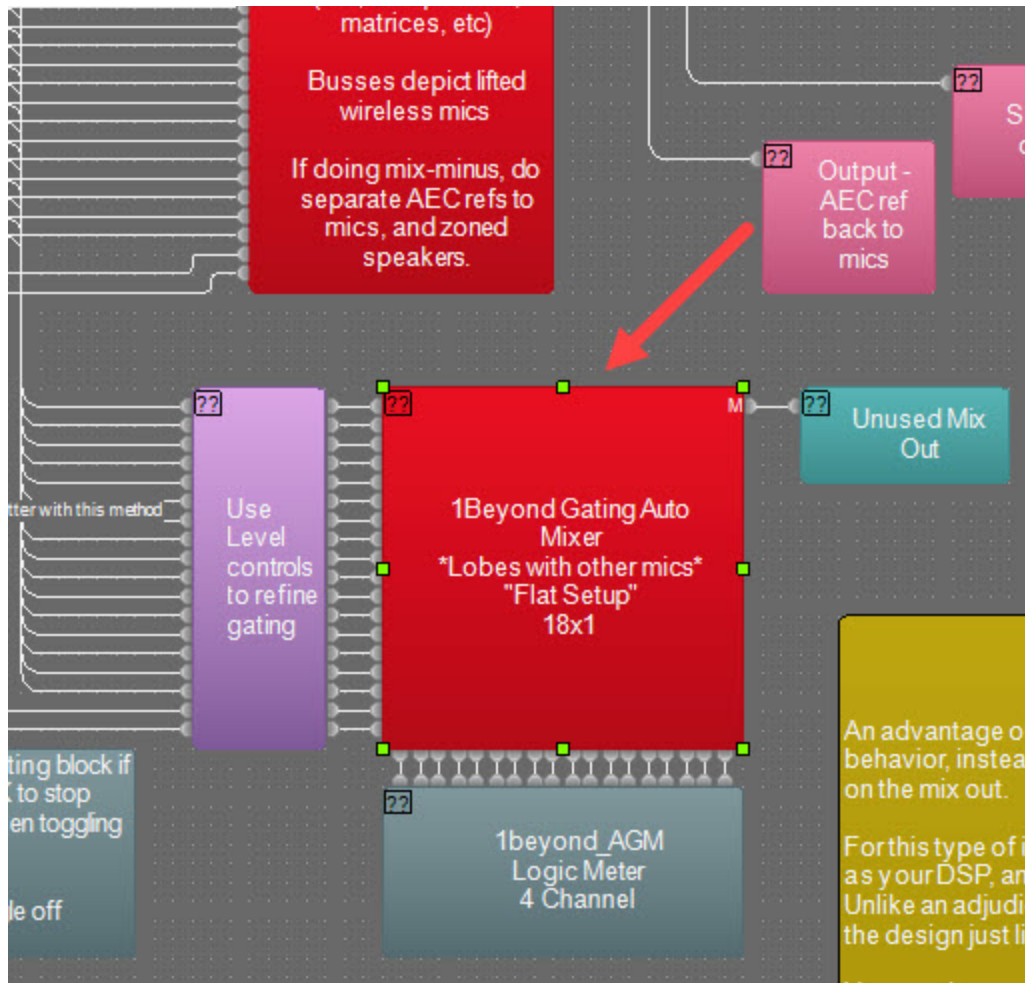



## 2. Select the mic symbol to open the **Mic Options**.

The screenshot displays a software interface for audio processing. A central window titled "1Beyond Gating Auto..." is open, showing a "Mic Options" sub-window. A red arrow points to a microphone icon in the "Mic Options" window. The background shows a complex signal flow diagram with various audio processing blocks. A yellow text box on the right provides detailed instructions and notes about the integration.

**Mic Options Window:**

Mic	Level	Mute	Out	Mixer	Bus
1	0.0	0		On	
2	0.0	2		On	
3	0.0	3		On	
4	0.0	4		On	
5	0.0	5		On	
6	0.0	6		On	
7	0.0	7		On	
8	0.0	8		On	
9	0.0	9		On	
10	0.0	10		On	
11	0.0	11		On	
12	0.0	12		On	
13	0.0	13		On	
14	0.0	14		On	
15	0.0	15		On	
16	0.0	16		On	
17	0.0	17		On	
18	0.0	18		On	

**Yellow Text Box:**

An advantage of this integration is you have much more finite control over lobe gating behavior, instead of relying on the MXA910's gate-on signal and a threshold reading on the mixout.

For this type of integration, your Room Design should have a single Mic Device set as your DSP, and the virtual mics will then correlate with the channels. Unlike an adjudicated setup, the input order of wireless mics does not matter, since the design just lines up with the channels.

You can then use the level block alone to control gating/AutoSwitching logic. If you need to get fancy due to bad mic placement, you can adjust the gain structure on the lobe output in addition to the level block to assist in attenuating the channels properly.

For this type of integration, the logic is as follows:

- Gate opens
- Noise Delay Starts
- Gate must stay open for length of Noise Delay

If it's still open when the Noise Delay expires, the position is added to the queue. If it's at the top of the queue, Automate VX switches to it.

To implement:

In addition to adding your DSP as a mic device, under the Adjudicator tab:

- Toggle on Adjudicator and select model
- Add IP address for unit the logic meter is allocated to.
- Fill out "meter label" with prefix to \_AGM in logic meter, so in this example you'd just put "1 beyond".
- Toggle OFF the adjudicator. Save project.

This ensures the logic meter is addressed.

**Goals for good AutoSwitching:**

- Ensure good separation of lobes, they autofocus 2 feet in any direction and have some pickup beyond the lobe. Superlobe positions as needed.
- Use level control on the channel status open consistently. Use the open as a question

- Use the arrow buttons under the **Open Mic Limits** header to set the limit of open mics to 2 or 3 depending on the number of channels used with Automate VX. For more information about channels in Automate VX, refer to [Configuring Adjudicators on page 90](#).

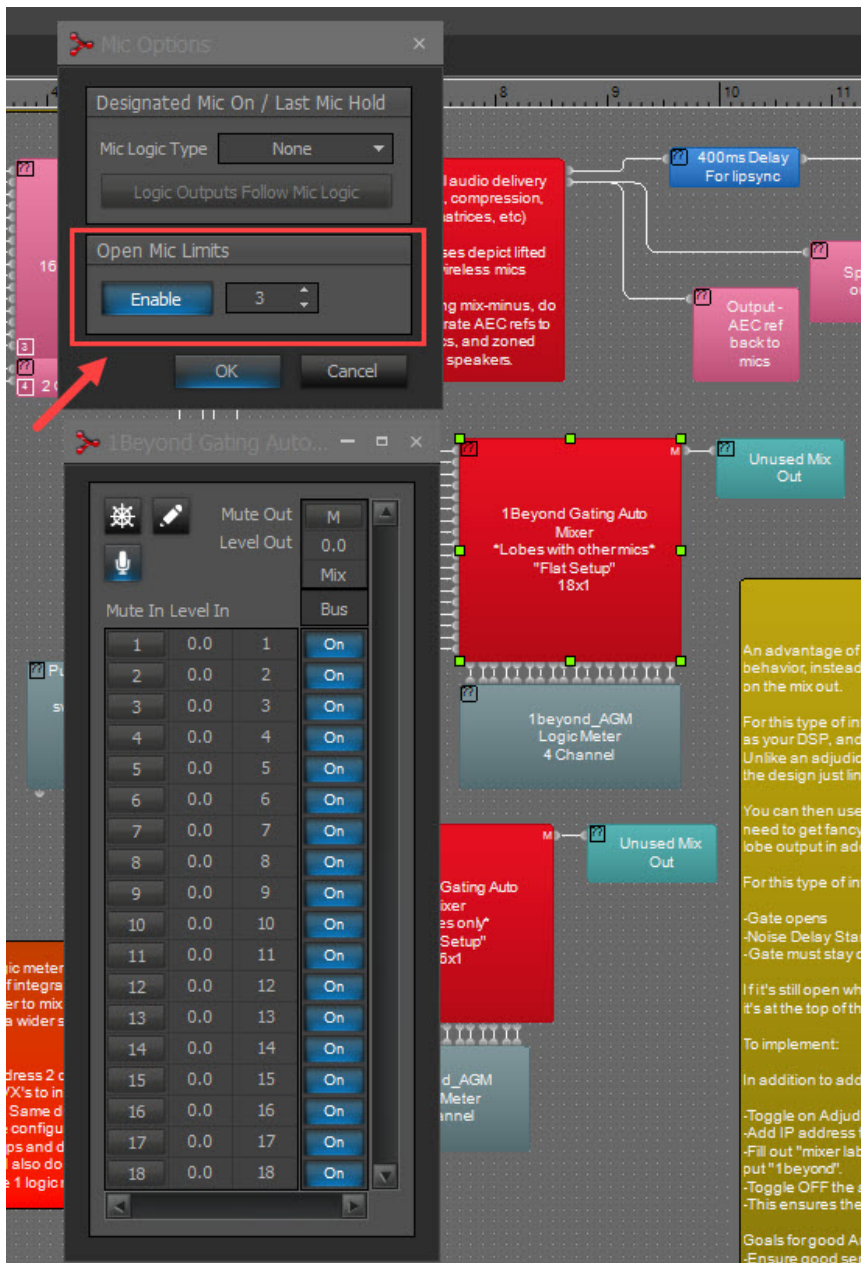

## Gate Hold Time

Adjusting the Gate Hold Time value eliminates accidental camera switching due to random audio during AutoSwitching. For more information about AutoSwitching, refer to [Main Menu on page 181](#).

To adjust the Gate Hold Time of a gating mixer channel:

1. Select the **Gating Auto Mixer** block to open the **Properties** menu.

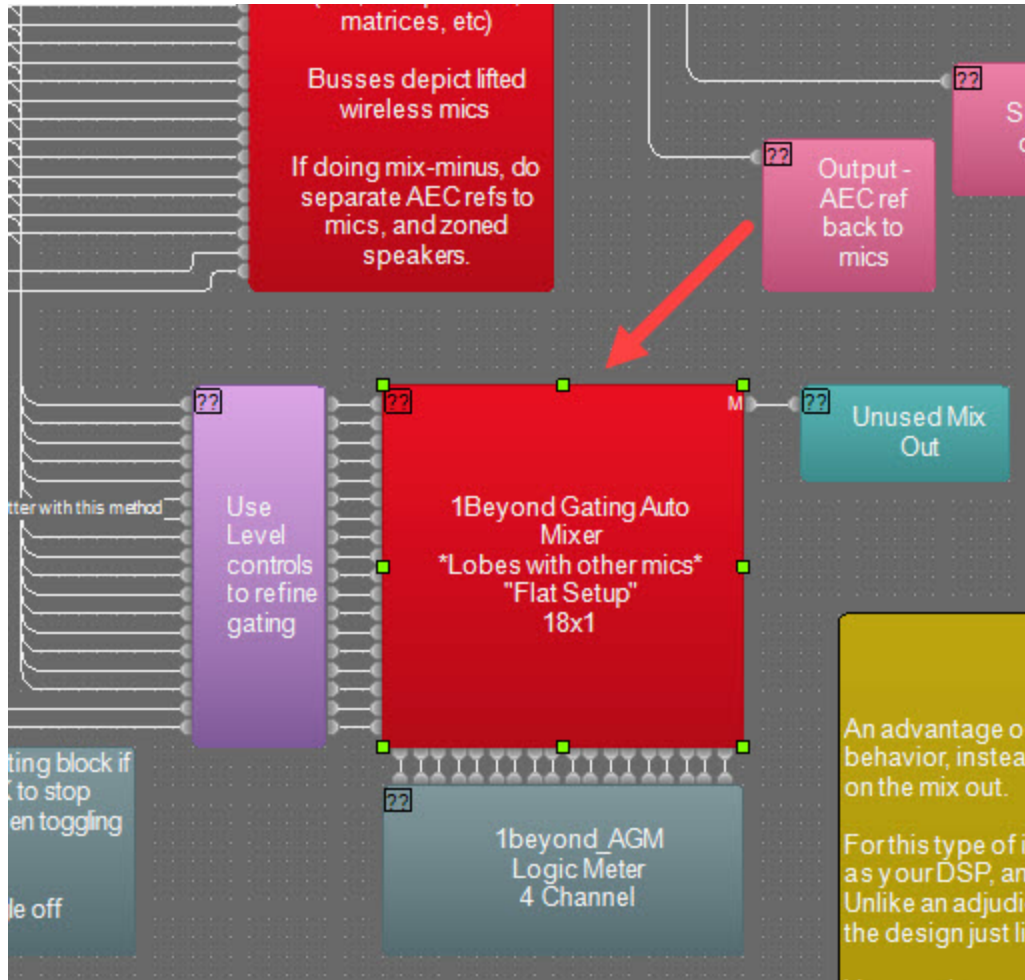



- Input 250 ms into the **Gate Hold Time (ms)** text field. Do this for all channels on the Gating Auto Mixer block.

The screenshot displays a software interface with a signal flow diagram on the left and a Properties panel on the right. The diagram shows a signal path starting from a 'Final audio delivery' block, passing through a '400ms Delay' block, and then to a 'Speaker output' block. Below this, there are two '1Beyond Gating Auto Mixer' blocks and two '1Beyond\_AGM LogicMeter' blocks. The Properties panel on the right is titled 'Mixer5' and shows various settings. The 'Gate Hold Time (ms)' field is highlighted with a red box and set to 250.0.

## Level Block

A Level block provides a better control of gating and AutoSwitching behavior with Automate VX. For more information about AutoSwitching, refer to [Main Menu on page 181](#).

To add a Level block to the project:

- On the Object Toolbar, select the **Control Components** button  to open the drop-down menu.

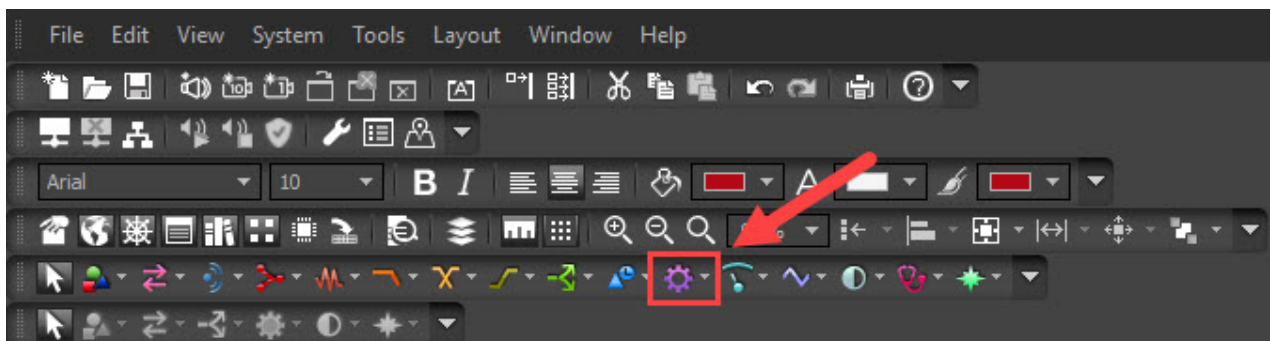

2. Select **Level**, then click the left mouse button inside the project to add the **Level** block. The **Level** block appears in the project.

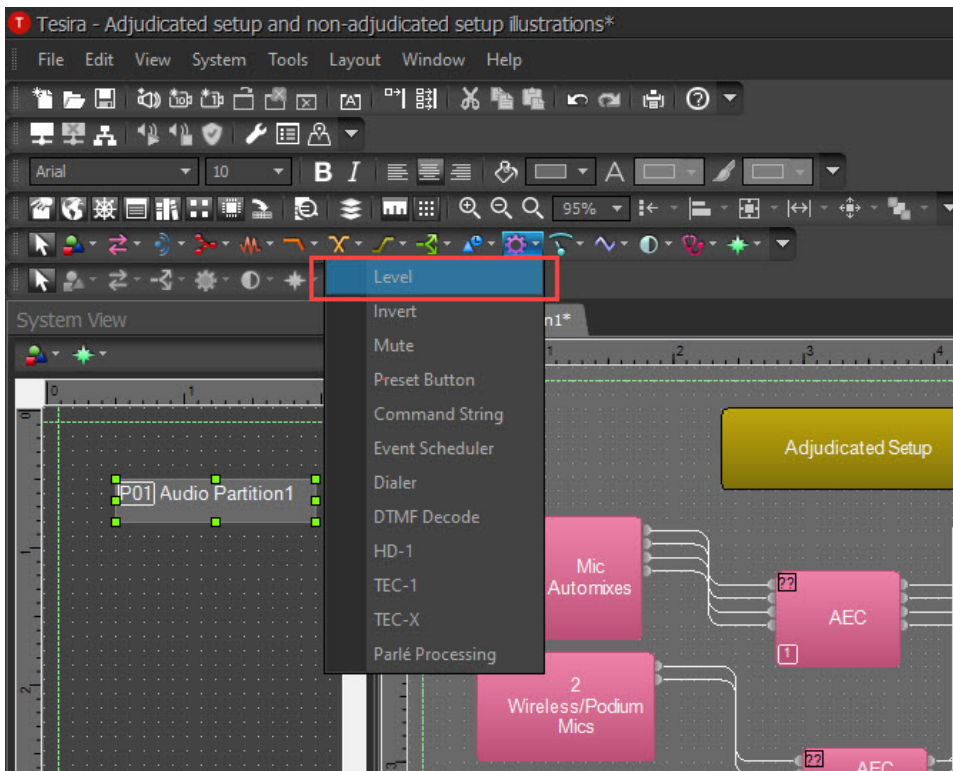

Level Block

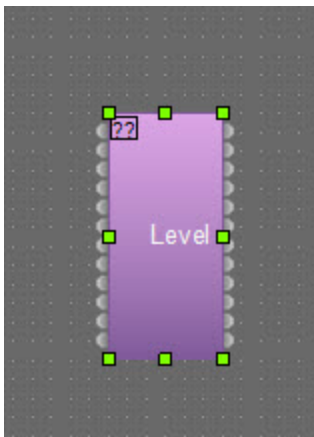

- Place the Level block before the gating mixer.
- Click and hold the left mouse button on a output node of the **Level** block, then drag the output node to the input node on the **Gating Auto Mixer** block to form a connection. Release the left mouse button once a connection is made. Do this for all output nodes on the **Level** block.

### Level Block in Project

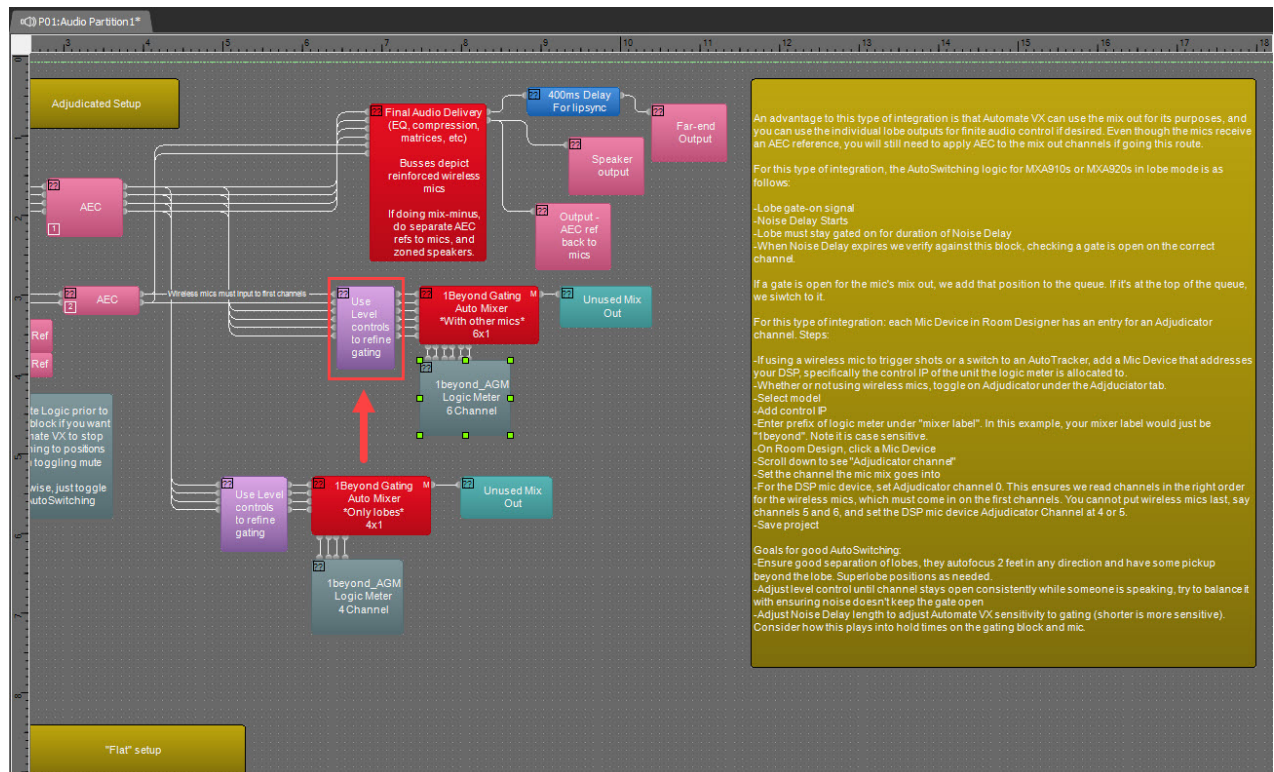

## Logic Meter

Automate VX requires logic feedback from audio passing through the DSP for AutoSwitching. For more information about AutoSwitching, refer to [Main Menu on page 181](#).

To add a Logic Meter block to the project:

1. Select **Logic Meter**, then click the left mouse button inside the project to add the **Logic Meter** block. The **Logic Meter** block appears in the project.

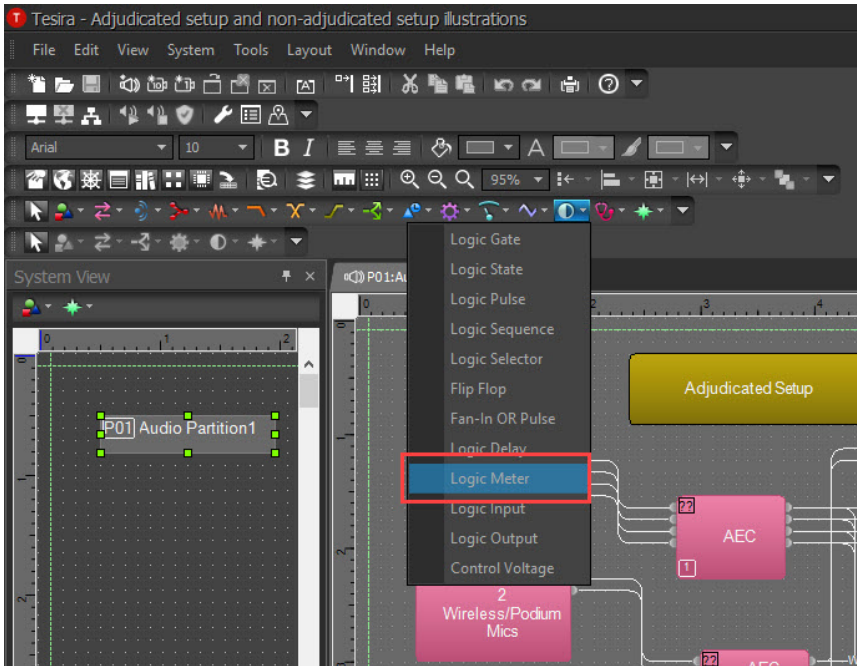

### Logic Meter

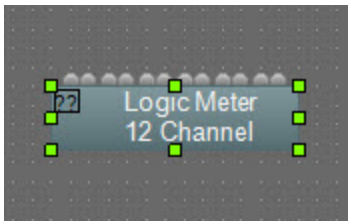



- In the **Channel Count** drop-down menu, select the exact amount of channels used by the gating mixer.

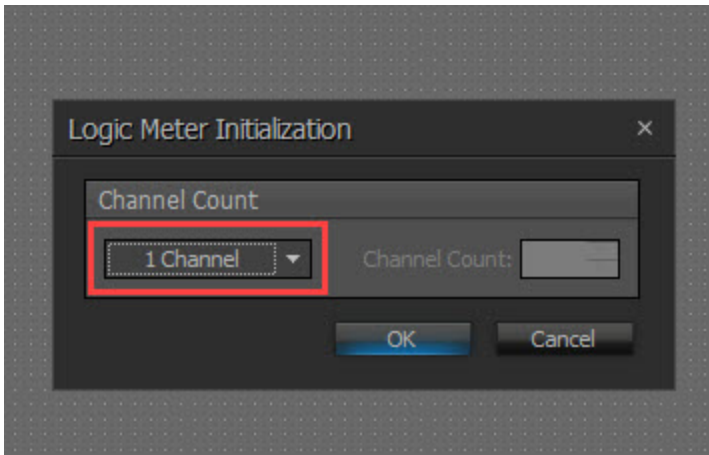

- Click and hold the left mouse button on a output node of the **Logic Meter** block, then drag the output node to a input node on the **Gating Auto Mixer** block. Release the left mouse button once a connection is made. Do this for all output nodes on the **Logic Meter** block.

### Logic Meter in Project

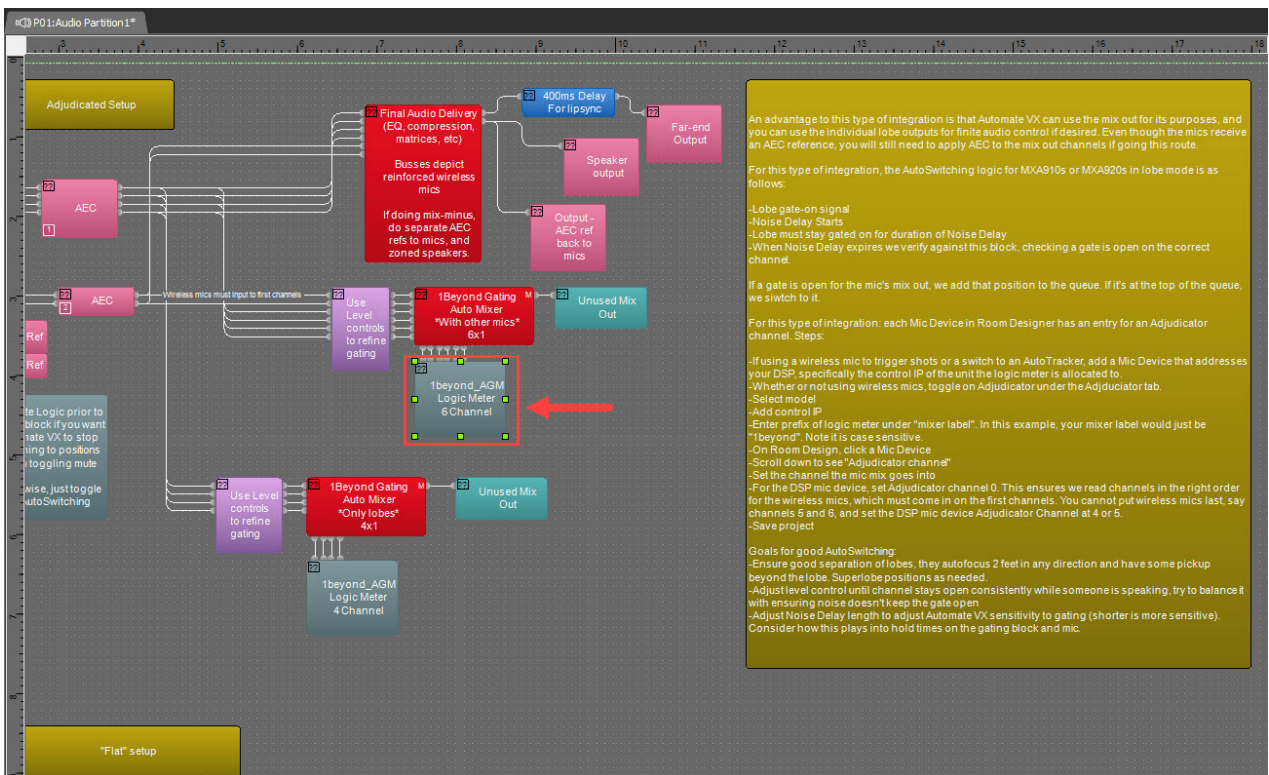

- Select the **Logic Meter** to open the **Properties** menu.

5. Input **1beyond\_AGM** into the **Instance Tag** text field. This changes the instance tag of the Logic Meter to **1beyond\_AGM**.

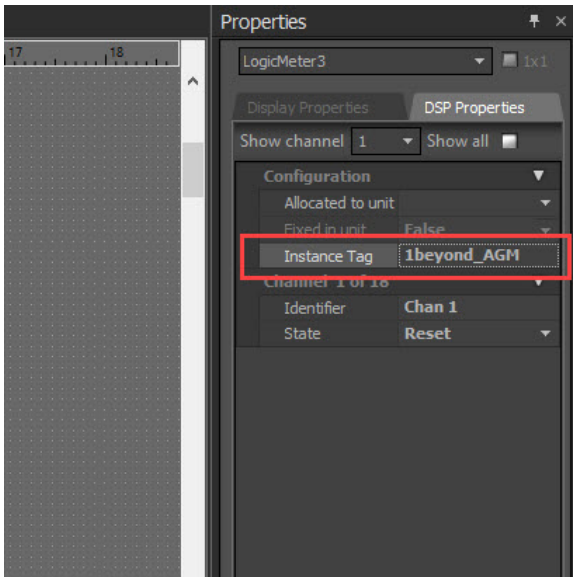

## Enable SSH

SSH (Secure Shell Protocol) must be enabled on the DSP device for Automate VX to communicate with the DSP. To enable SSH on a Biamp Tesira DSP:

1. On the top toolbar, select **System** to open the drop-down menu.
2. Select **Network**, then select **Perform Device Maintenance...**

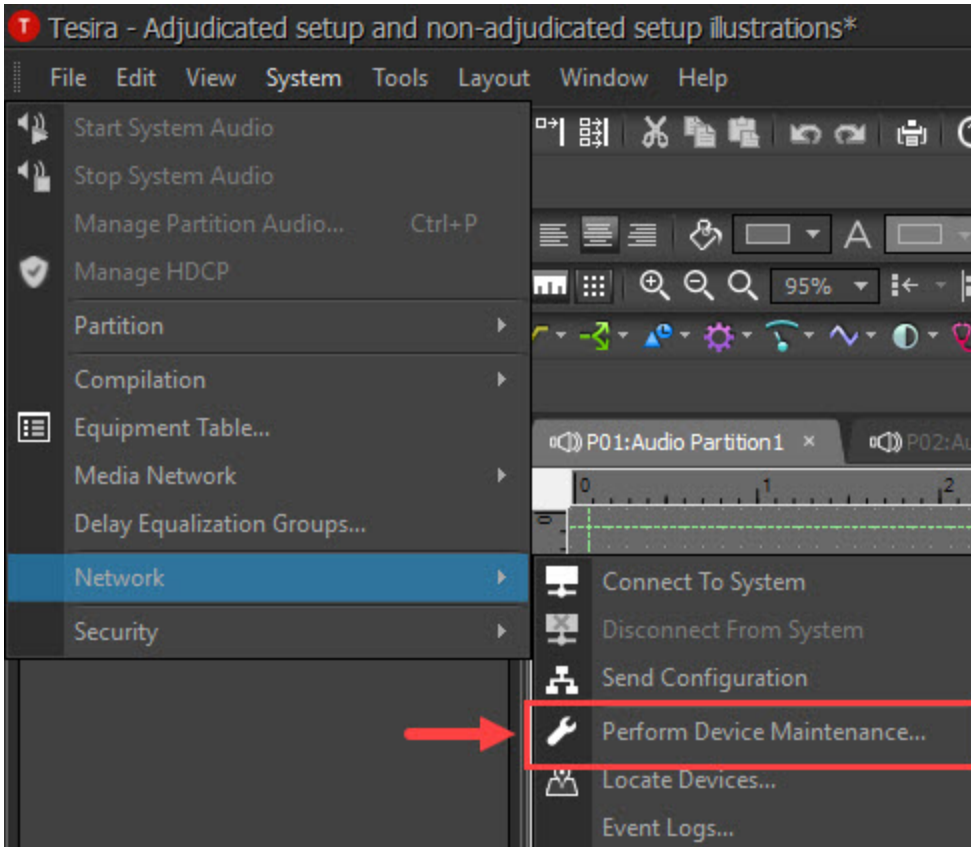

3. Select the **Control Network** tab, then select the **Enable SSH** check box under the **Services** header.

### Network Settings

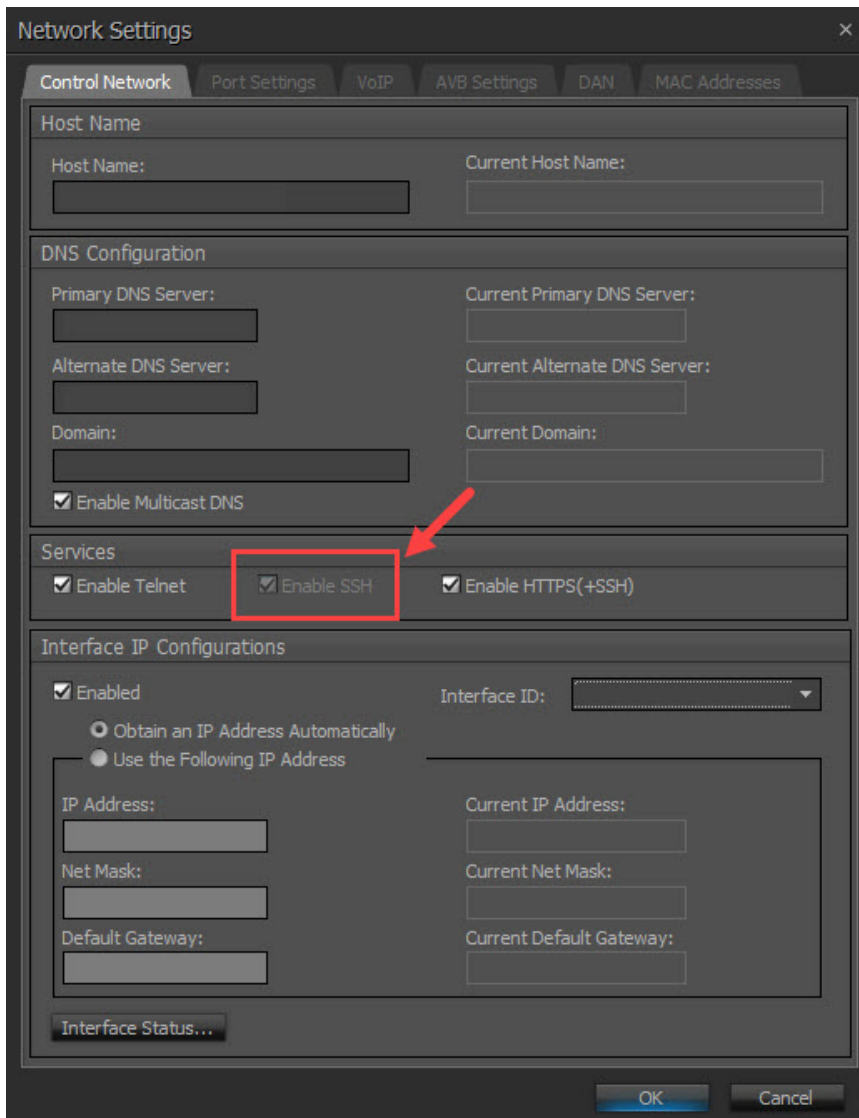

The screenshot shows the 'Network Settings' dialog box with the 'Control Network' tab selected. The 'Services' section contains three checkboxes: 'Enable Telnet', 'Enable SSH', and 'Enable HTTPS(+SSH)'. The 'Enable SSH' checkbox is highlighted with a red box and a red arrow pointing to it. Other sections include 'Host Name', 'DNS Configuration', and 'Interface IP Configurations'.

Network Settings

Control Network | Port Settings | VoIP | AVB Settings | DAN | MAC Addresses

Host Name

Host Name:  Current Host Name:

DNS Configuration

Primary DNS Server:  Current Primary DNS Server:

Alternate DNS Server:  Current Alternate DNS Server:

Domain:  Current Domain:

Enable Multicast DNS

Services

Enable Telnet  **Enable SSH**  Enable HTTPS(+SSH)

Interface IP Configurations

Enabled Interface ID:

Obtain an IP Address Automatically

Use the Following IP Address

IP Address:  Current IP Address:

Net Mask:  Current Net Mask:

Default Gateway:  Current Default Gateway:

Interface Status...

OK Cancel



## AEC Reference

If a ceiling array microphone is in the room, an AEC (Acoustic Echo Cancellation) reference must be sent for it. If there are multiple ceiling array microphones, ensure that an AEC reference is sent for each ceiling array microphone. For more information about ceiling array microphones, refer to [Microphone Device Configuration on page 67](#)

### AEC Reference Example

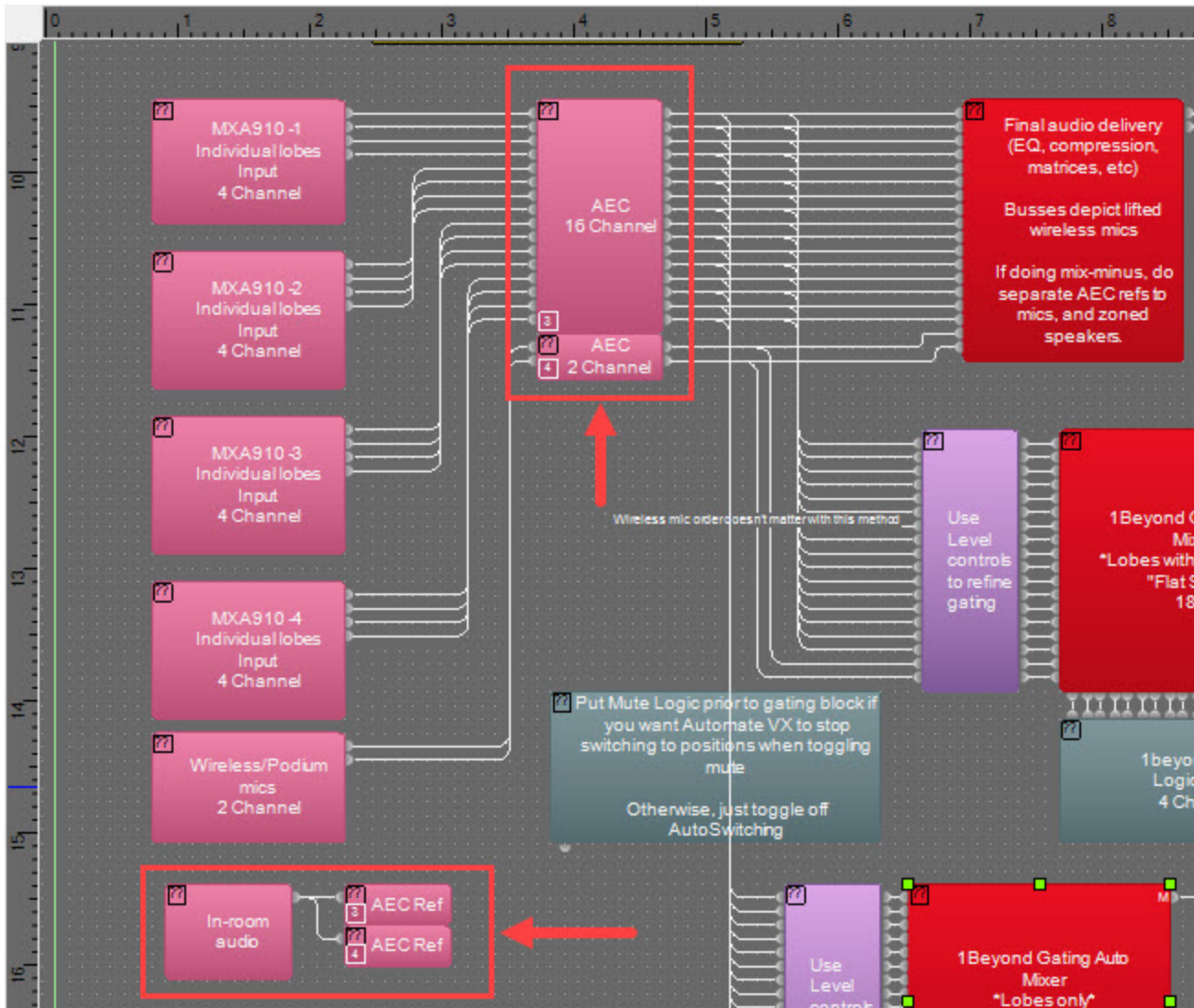

## Delay Block

A delay block is required in the project for the audio to properly sync with the video output from Automate VX. To add and configure a delay block in the project:

1. On the Object Toolbar, select the **Delay Components** button  to open the drop-down menu.

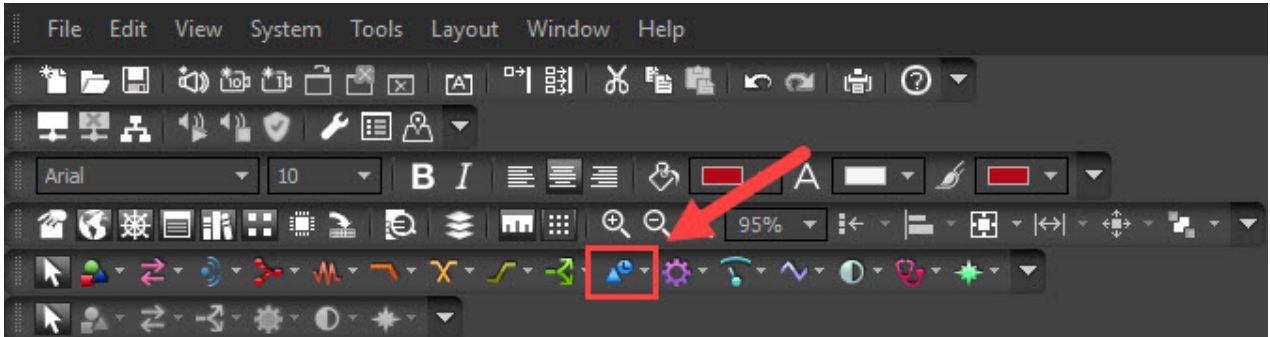

2. Select **Delay**, then click the left mouse button inside the project to add the Delay block. The **Delay** block appears in the project.

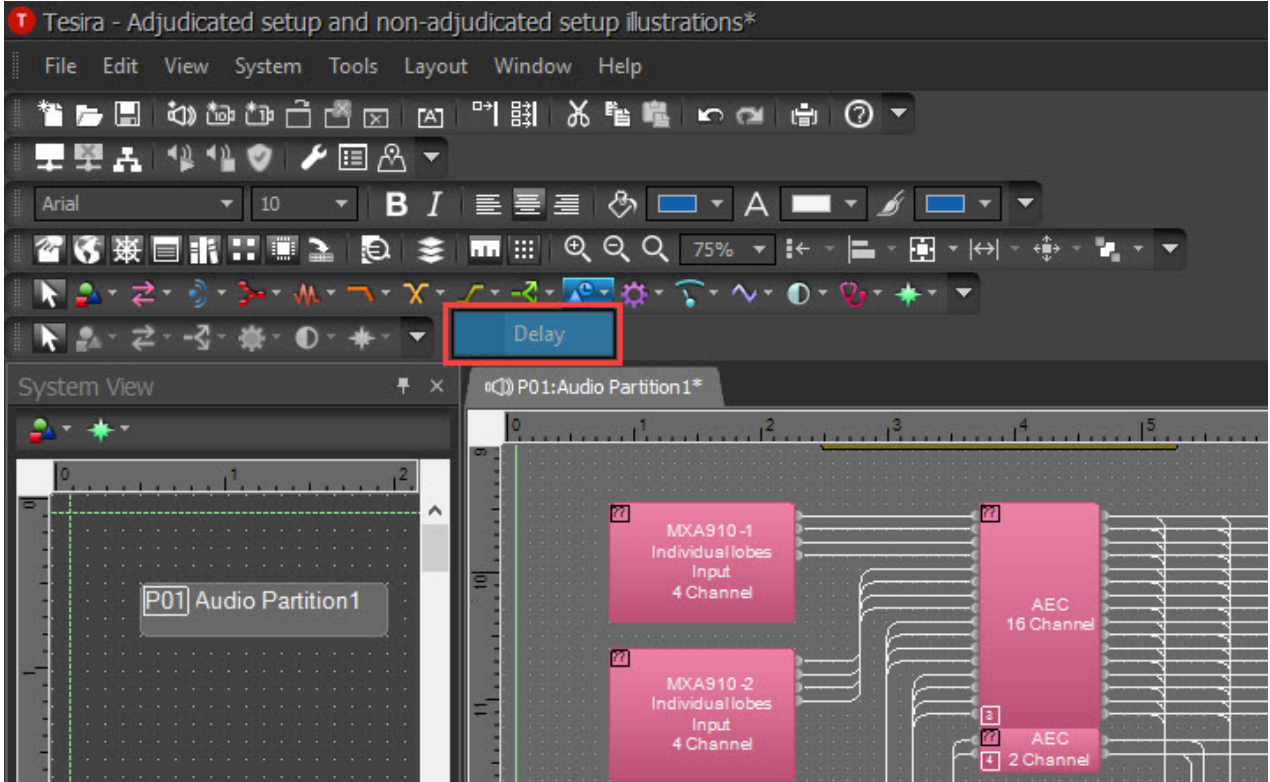

### Delay Block

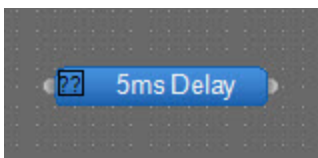

3. Select the **Delay** block to open the Properties menu.

- Input 400 into the **Delay** text field. A 400 ms delay ensures that the audio syncs with the Automate VX video feed.

**NOTE:** If NDI cameras are used with Automate VX, the delay may need to be increased to 450 ms. This is due to the added latency over the network. Test the video output from Automate VX with this value and adjust the delay accordingly to sync the audio and video.

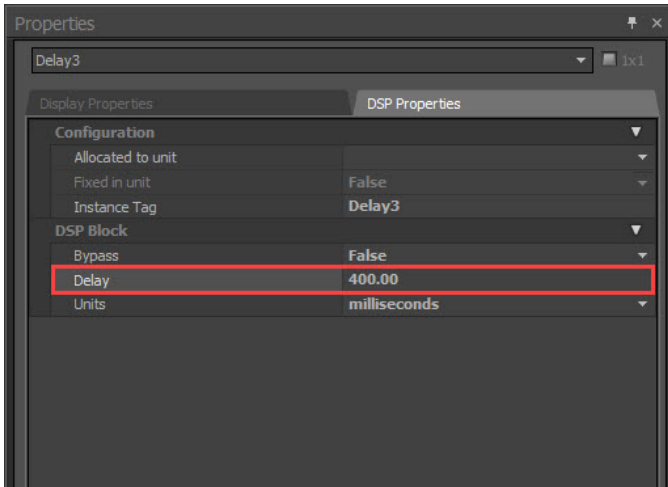

### Delay Block in Project

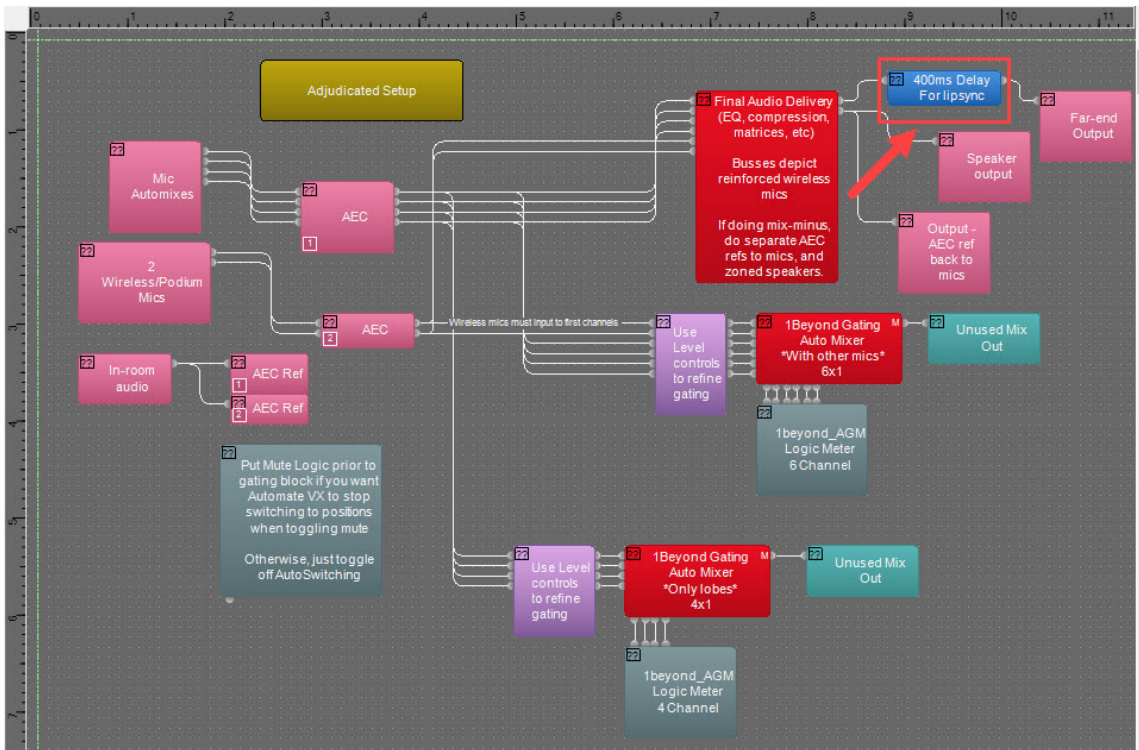

# QSC Q-SYS™ Core Configuration for Automate VX

The following items are required to integrate a QSC Q-SYS™ Core DSP with Automate VX:

- IV-SAM-VXS-1B, IV-SAM-VXP-1B, or IV-SAM-VXN-1B.
- QSC Q-SYS Core 110F, QSC Q-SYS Core 510i, or QSC Q-SYS Core 610.
- A computer with the latest version of Q-SYS Designer software.

Before configuring the QSC Q-SYS Core DSP to communicate with Automate VX, complete the following procedure to open the Q-SYS Designer project file:

1. Open Q-SYS Designer software on a computer. Ensure that it is the newest version of the software.
2. Select **File** in the top left corner of the software.
3. Select **Open**, then select the project for the room that is going to be used with Automate VX.

## Gating Mixer

A Q-SYS Core DSP requires a legacy gating mixer block to properly communicate with Automate VX. Complete the following procedure to add a legacy gating mixer to the Q-SYS Designer project:

1. Select the **Schematic Elements** menu. The Schematic Elements menu opens, and the Components menu is displayed.

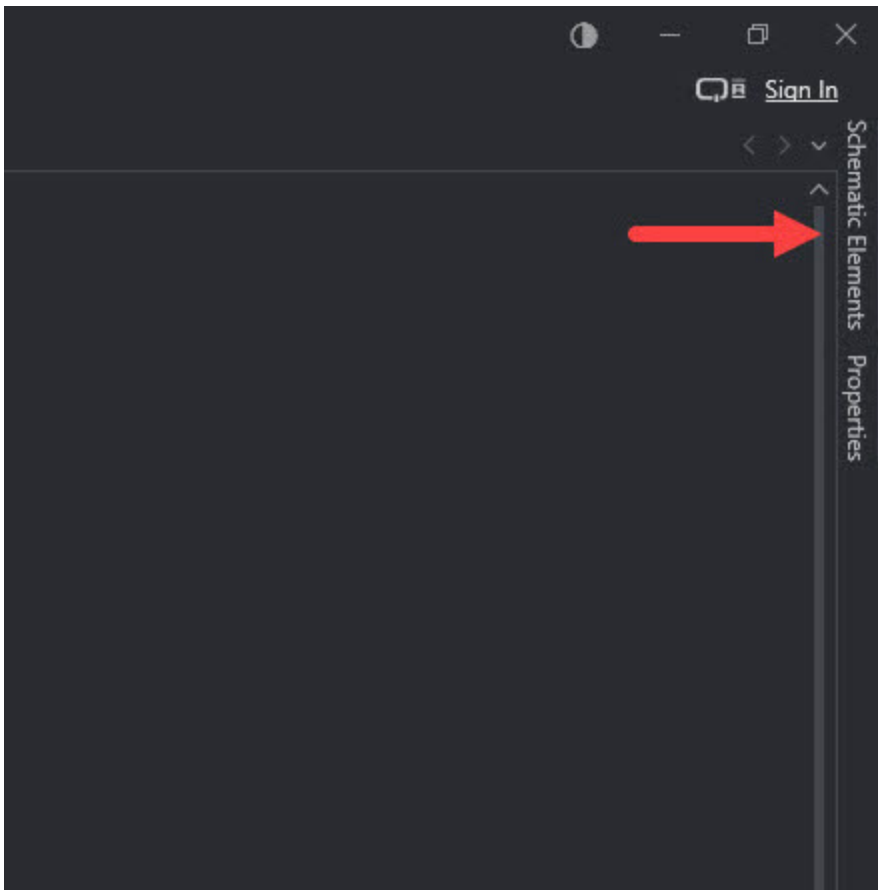

2. Select **Audio Components** to show more components, then select **Mixers** to expand the Mixers menu.

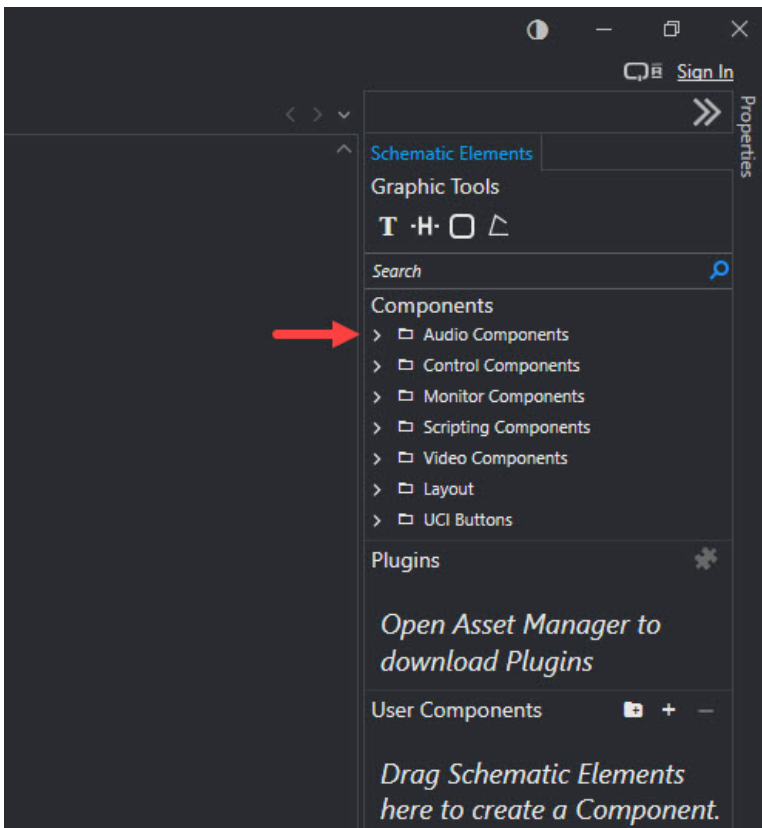

## Audio Components Menu

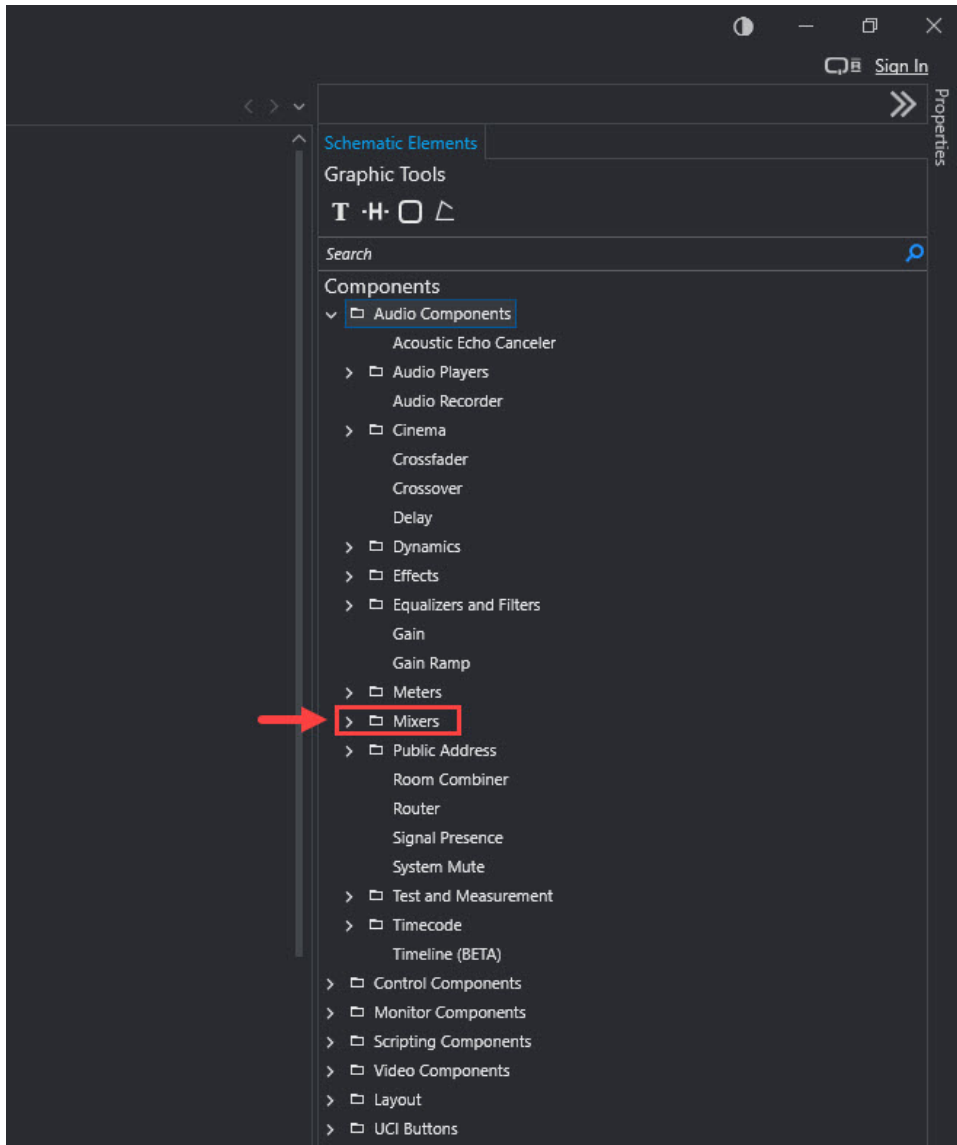

3. In the Mixers menu, select **Gating Automatic Mic Mixers**. The Gating Automatic Mic Mixers menu opens.

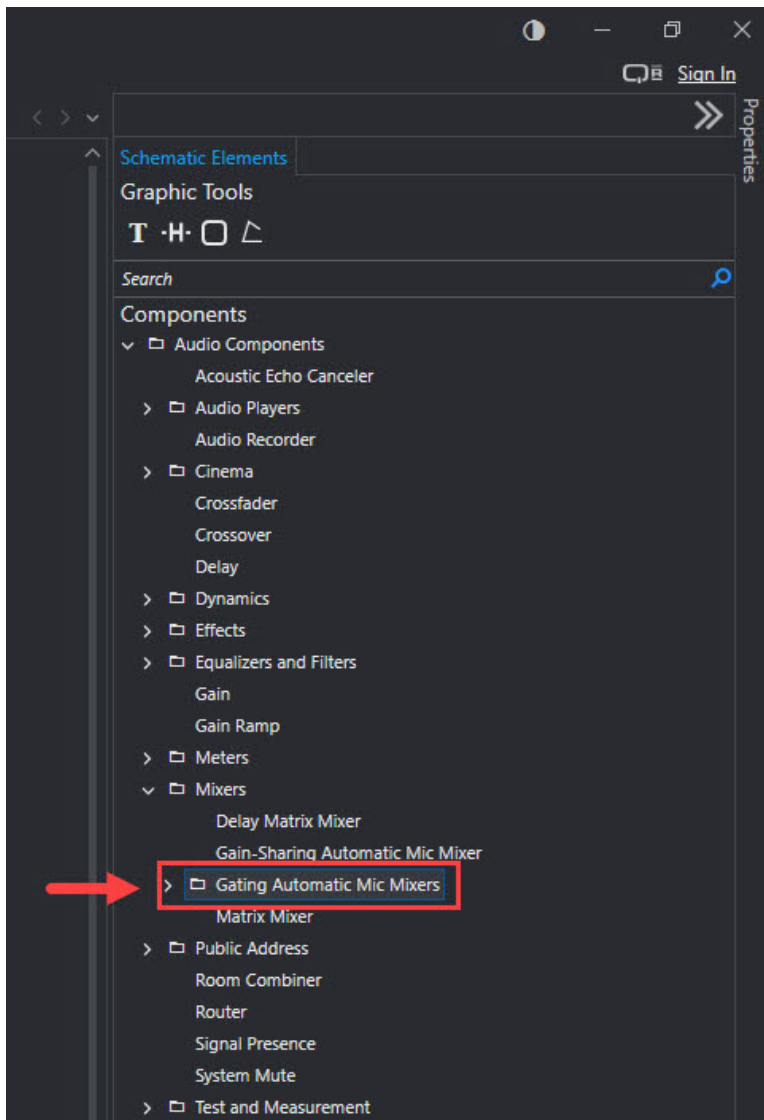



- Click and hold the left mouse button on **Absolute Threshold (Legacy)**, then drag **Absolute Threshold (Legacy)** into the project. Release the left mouse button to insert the **Gating Automatic Mic Mixer (Legacy)** block into the project.

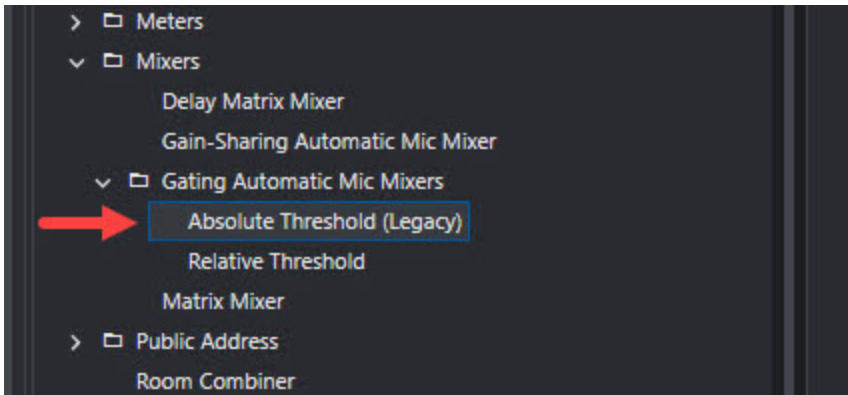

Gating Mixer Block

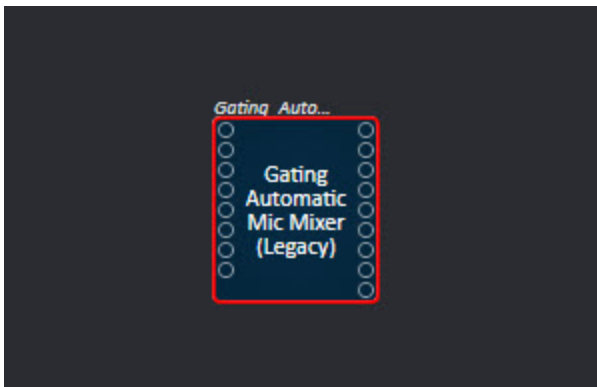



## Gating Mixer Properties

The properties of the gating mixer block must be changed to communicate with Automate VX. To set the properties of the gating mixer block:

1. Select the **Gating Automatic Mic Mixer (Legacy)** block, then select **Properties**.

**NOTE:** The **Gating Automatic Mic Mixer (Legacy)** block is the **Absolute Threshold (Legacy)** component from the previous section. For more information on adding a **Gating Automatic Mic Mixer (Legacy)** to the project, refer to [Gating Mixer on page 163](#).

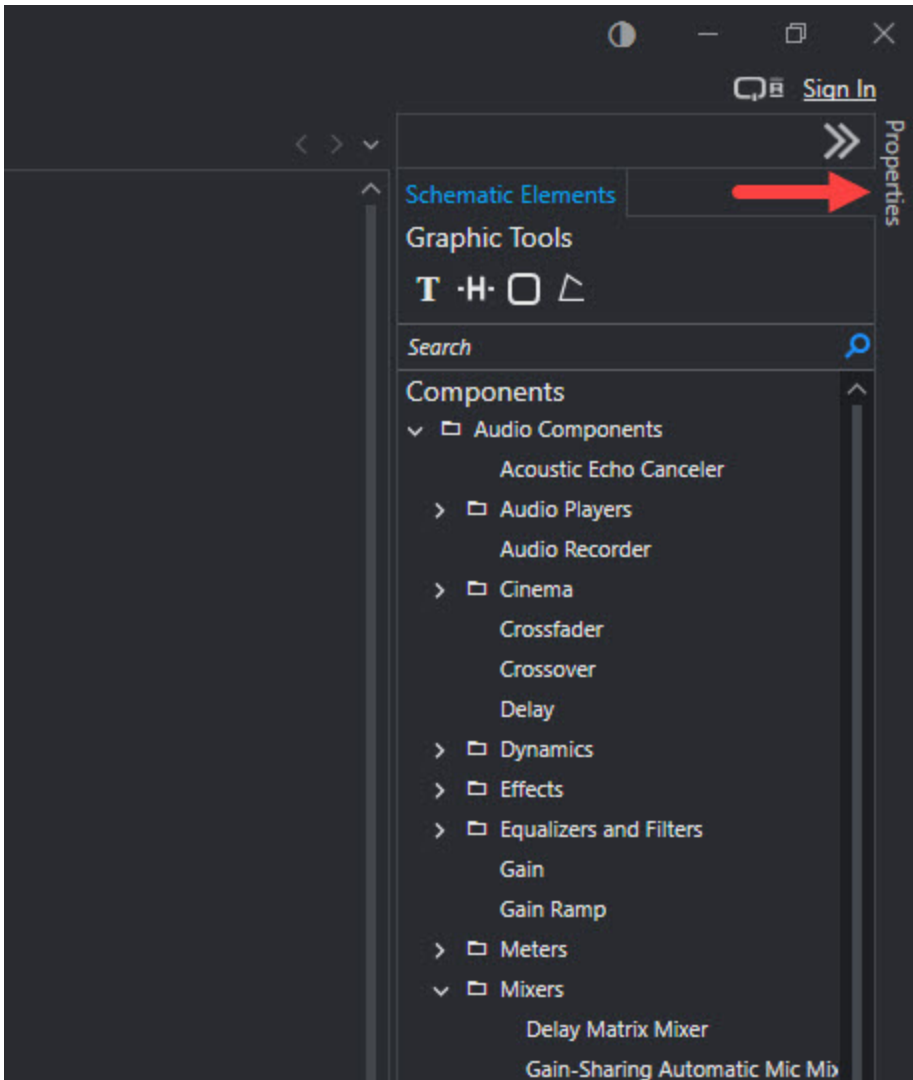

- In the Properties menu, select the **Channels** text field. Input the same number of channels used in the AutoSwitching configuration. For more information about channels in Automate VX, refer to [Configuring Adjudicators on page 90](#).

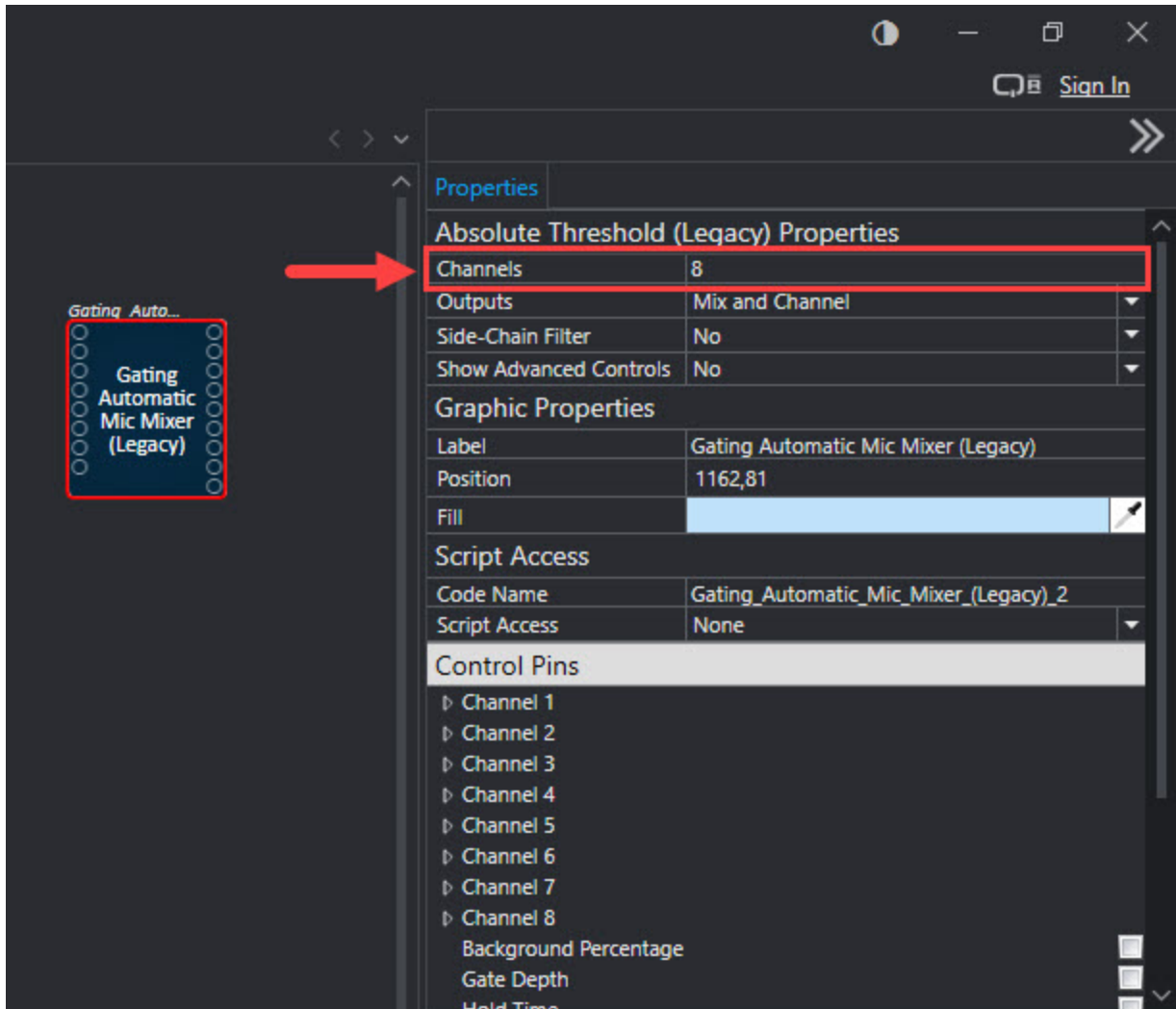

3. In the Properties menu, use the **Code Name** text field to change the gating mixer code name to **1beyond:GatingAutomaticMicMixer(Legacy)**. For Q-SYS Designer software versions 9.5 and prior, change the code name of the gating mixer to **1beyond**.

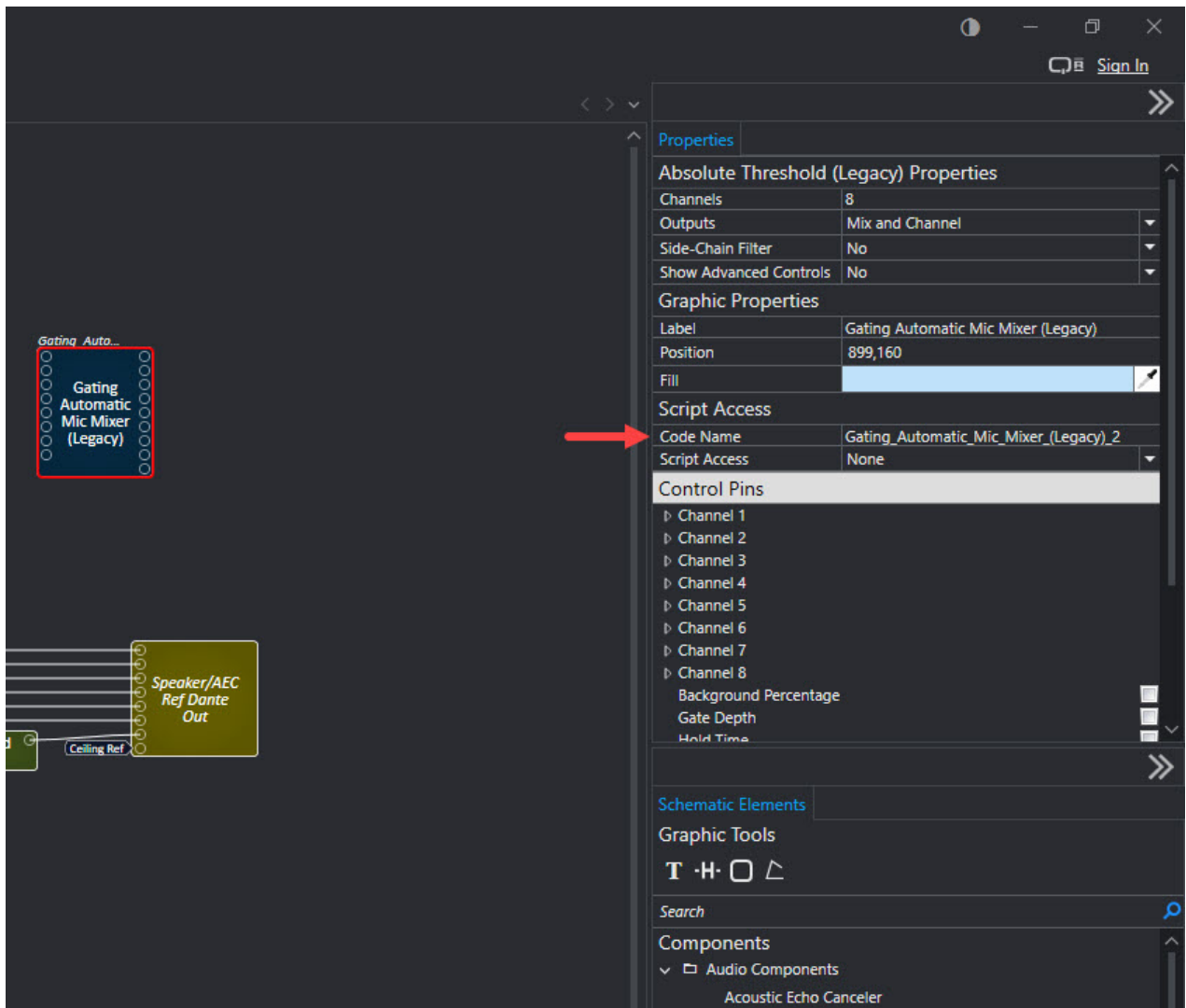

## NOTES:

- The **Gating Automatic Mic Mixer (Legacy)** is a separate, but parallel gating mixer to the one used for audio processing.
- The audio is routed into the gating mixer after AEC and room mutes, but before other audio processing (EQ, compression, and so forth).

## Gating Mixer in Project

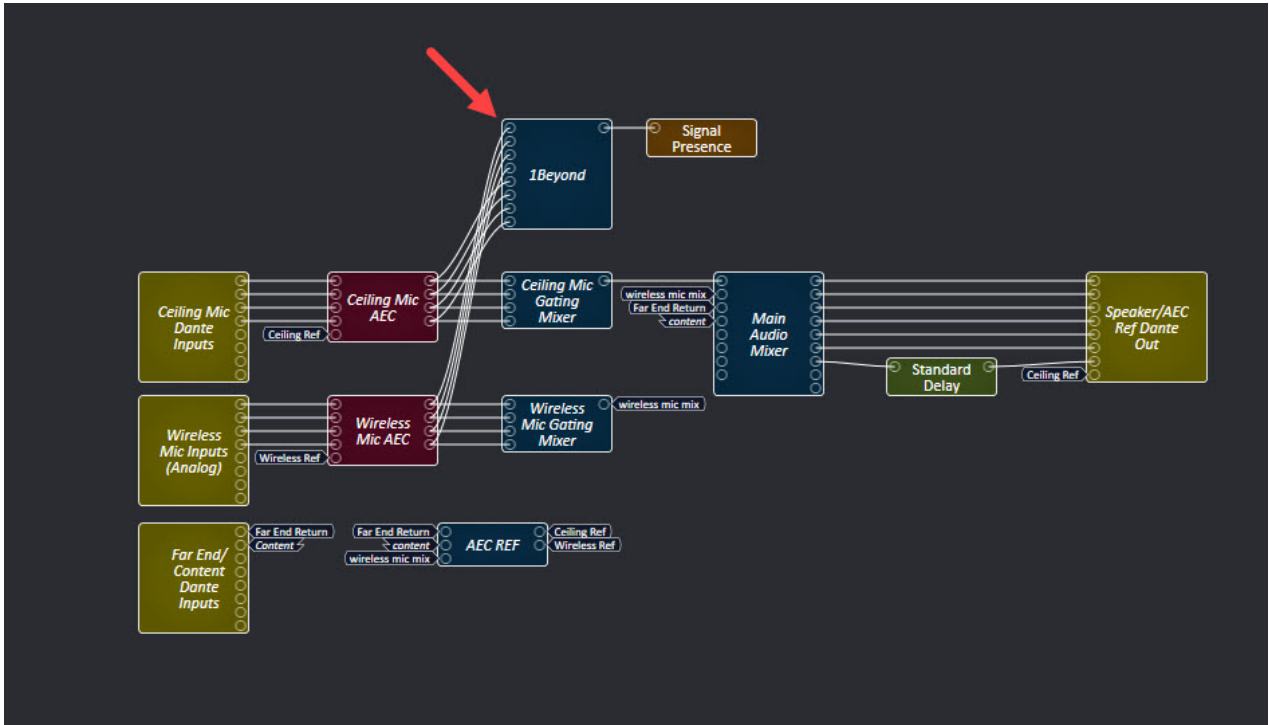

## Named Controls

The channels of the gating mixer require a specific naming convention to communicate with Automate VX. To set the named controls for the channels of the gating mixer:

1. Double-click the left mouse button on the **Gating Automatic Mic Mixer (Legacy)** block. The mixer block settings window is displayed.

**NOTE:** The **Gating Automatic Mic Mixer (Legacy)** block requires the code name **1beyond:GatingAutomaticMicMixer(Legacy)**. For more information on gating mixer properties, refer to [Gating Mixer Properties on page 168](#)

## Mixer Block Selection

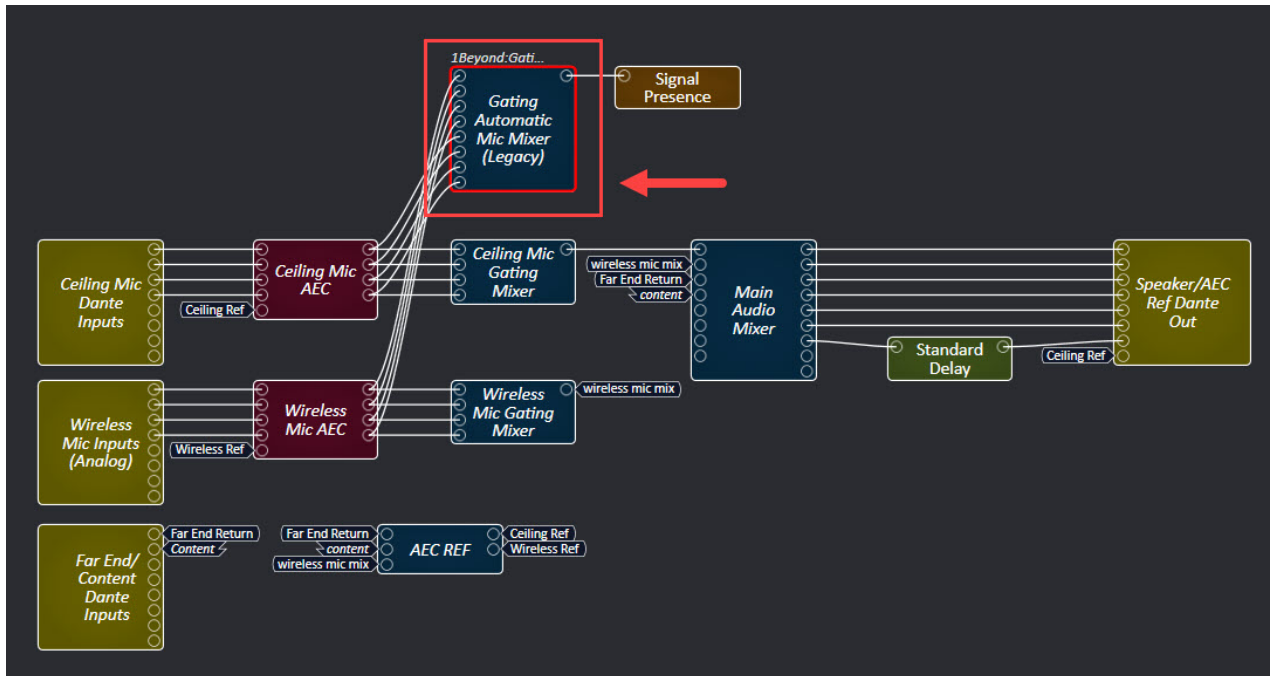

## Mixer Block Settings Window

The screenshot shows the configuration interface for the '1Beyond : Gating Automatic Mic Mixer (Legacy)'. The interface is divided into several sections:

- Input:** Controls for 8 individual inputs, including 'Open' (checkboxes), 'Manual' (sliders), 'Mode' (dropdowns set to 'Automatic'), 'Priority' (checkboxes set to '1'), and 'Threshold' (sliders set to '-37.0dB').
- Mix:** Includes a 'Mute' button and a 'Gain' slider set to '0dB'.
- Gate:** Includes 'Last Mic On' (checkbox), 'ID Gating' (checkbox), 'Background Percentage' (slider set to '0%'), 'Depth' (slider set to '60.0dB'), and 'Hold Time' (slider set to '250ms').
- NOM:** Includes 'Max NOM' (set to '3'), 'Response Time' (slider set to '10.0ms'), and 'Gain' (slider set to '0dB').

2. Select **Named Controls** on the bottom left side of the software screen. This expands the Named Controls menu.

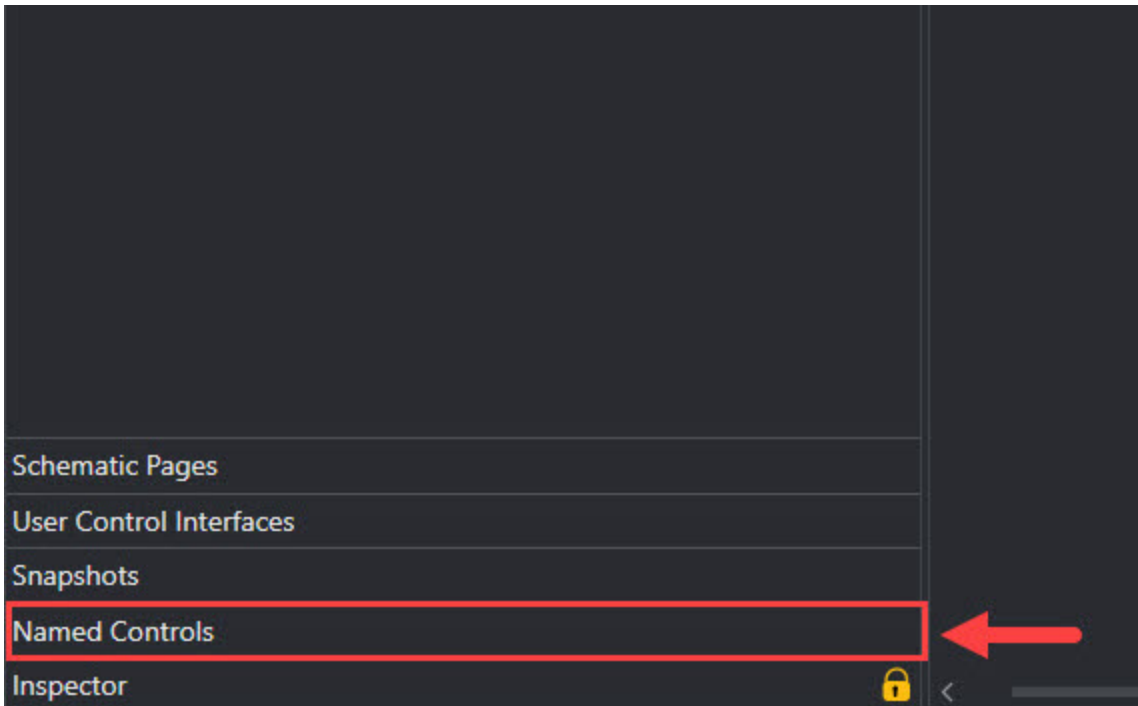

3. In the mixer blocks settings window, click and hold the left mouse button on an open gate and drag the gate into the named controls. Do this step for each open gate. Each channel within the named controls should have the name **1beyond:GatingAutomaticMicMixer(Legacy)channel#open**.

### Named Controls Menu

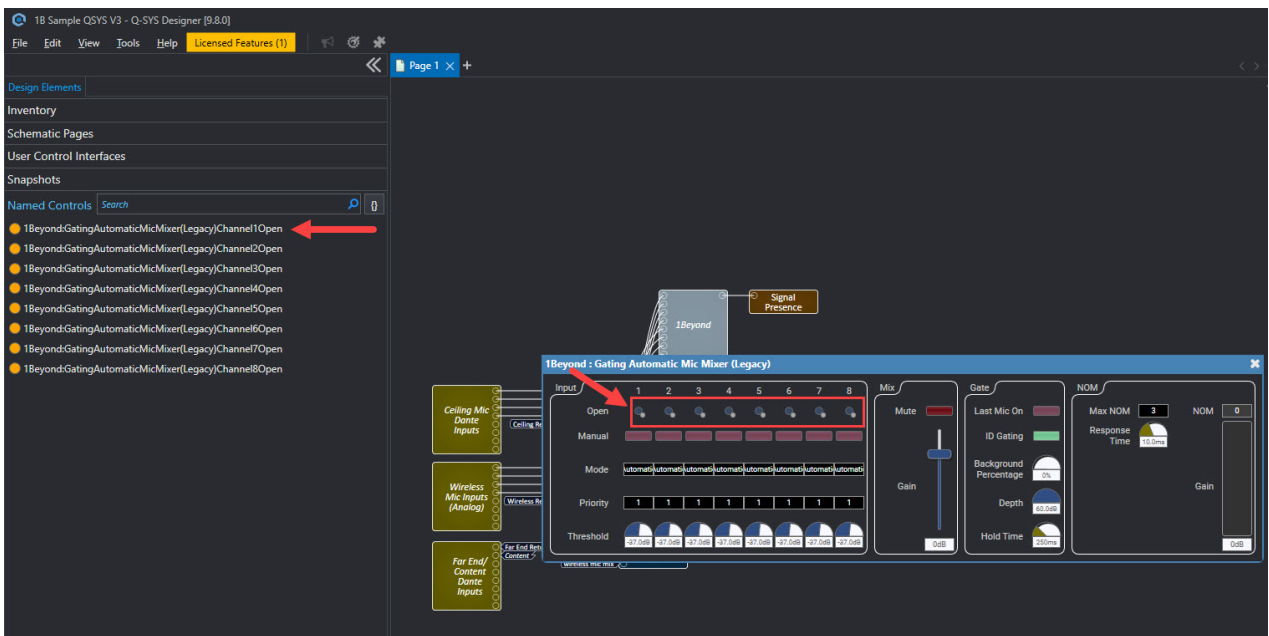

## Settings

Certain settings of the gating mixer block provide a better AutoSwitching experience with Automate VX. Complete the following procedure to configure the settings of the gating mixer block:

1. Double-click the left mouse button on the **Gating Automatic Mic Mixer (Legacy)** block. The mixer block settings window is displayed.

### Mixer Block Selection

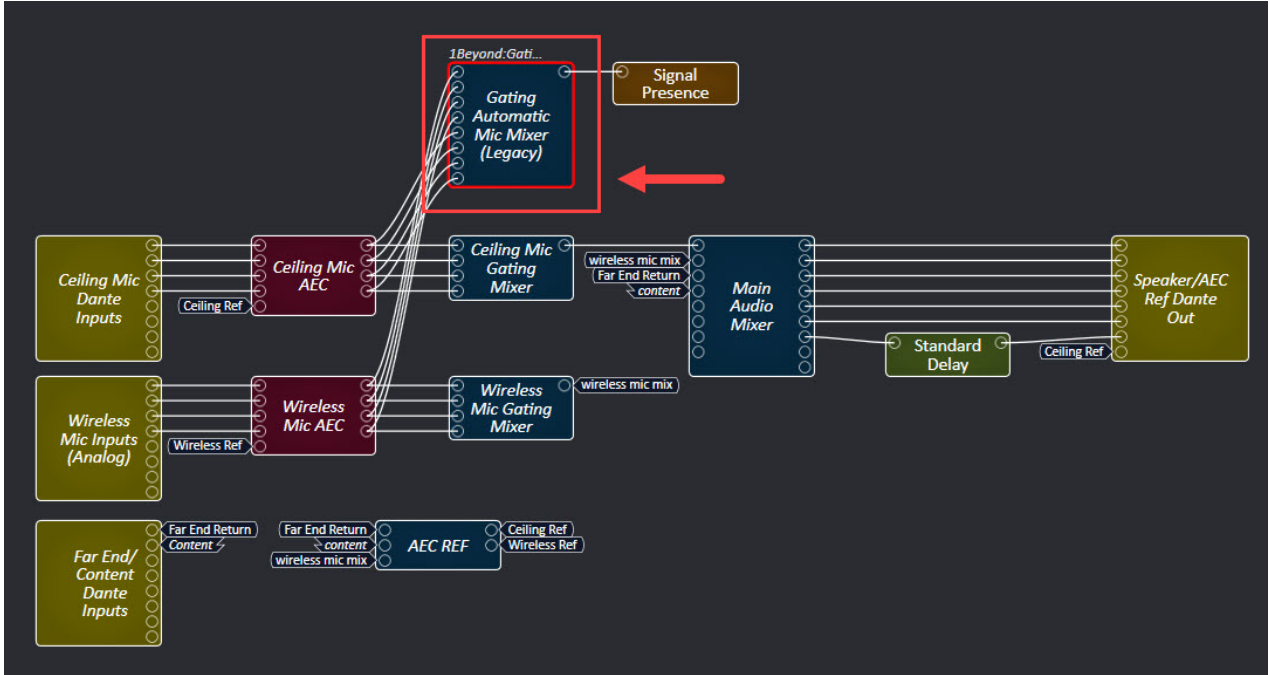

### Mixer Block Settings Window

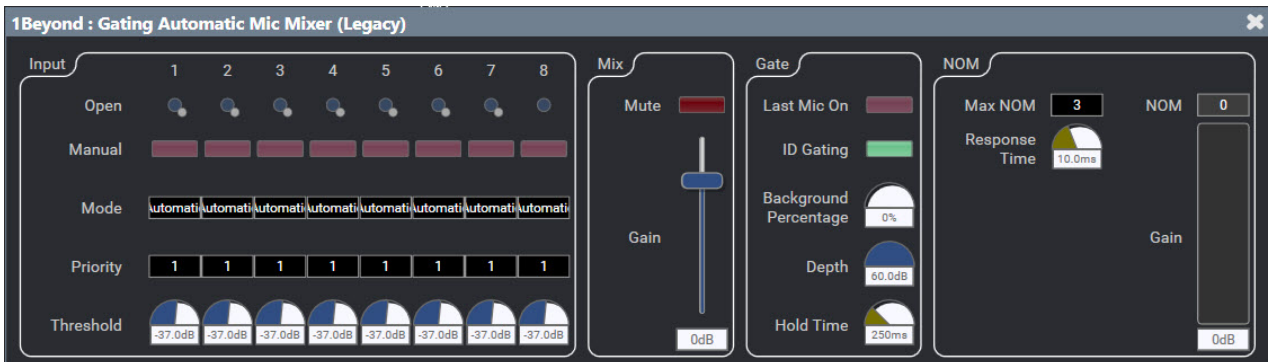

2. Select **File** in the top left corner of the software screen. Then, select **Emulate**.

**NOTE:** Alternately, press the **F6** button on the keyboard to activate **Emulate**.

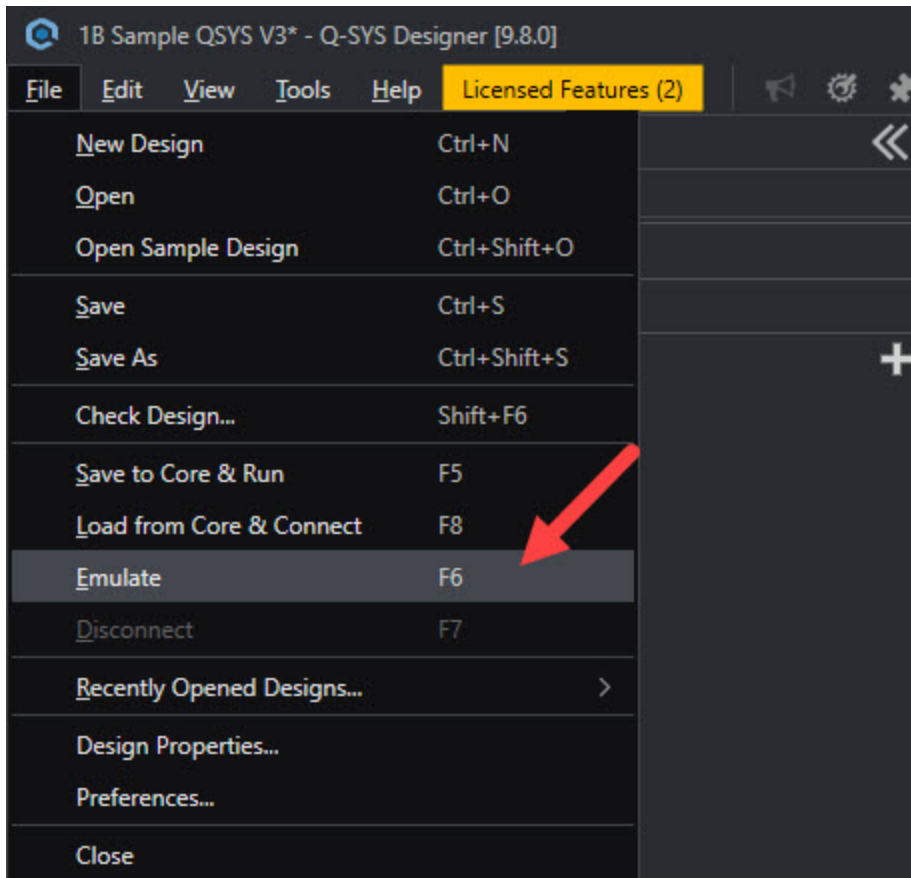

3. In the mixer block settings window, select the **Hold time** dial. Then, type 250 on the keyboard to set the **Hold Time** to **250 ms** for all channels.

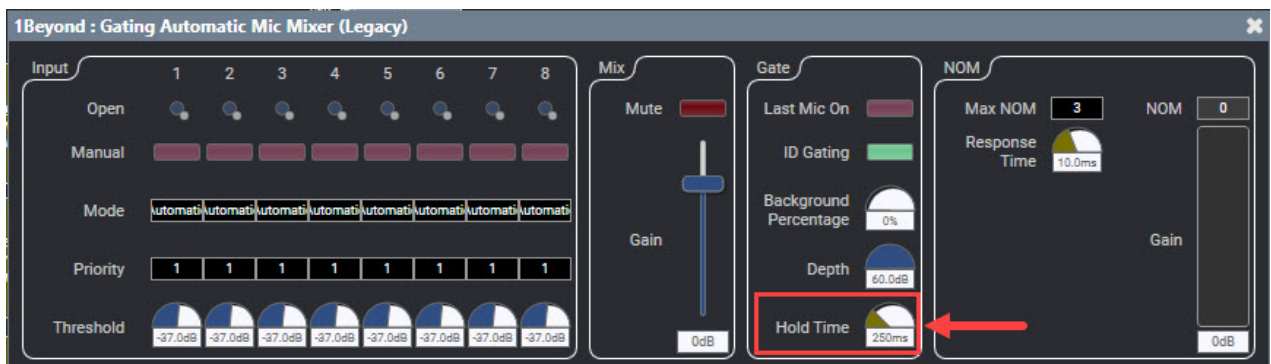



- In the mixer block settings window, use the **Max NOM** text field to set the NOM (Number of Open Mics) to 2 or 3 depending on the number of channels. For more information about channels in Automate VX, refer to [Configuring Adjudicators on page 90](#).

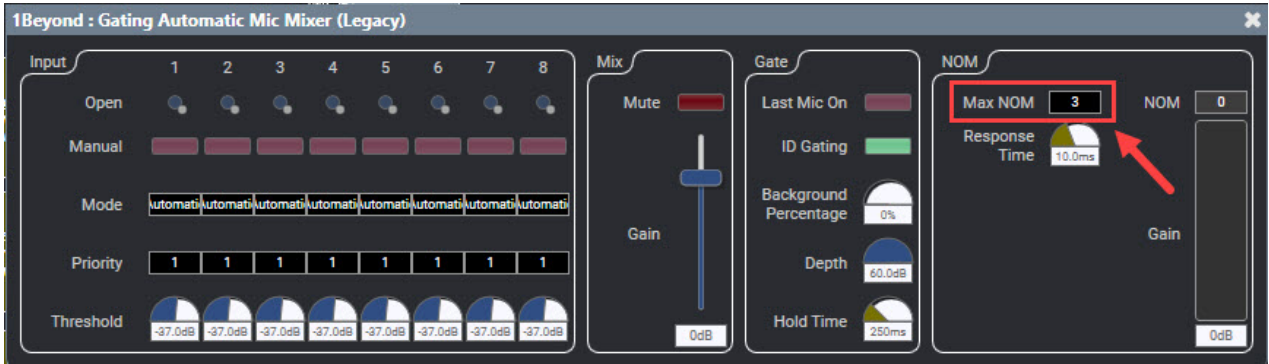

- In the mixer block settings window, ensure that the **Last Mic On** setting is set to off. The status of the **Last Mic On** setting is determined by the red button, the button glows red when it is on. Select the button next to **Last Mic On** to switch the setting to on or off.

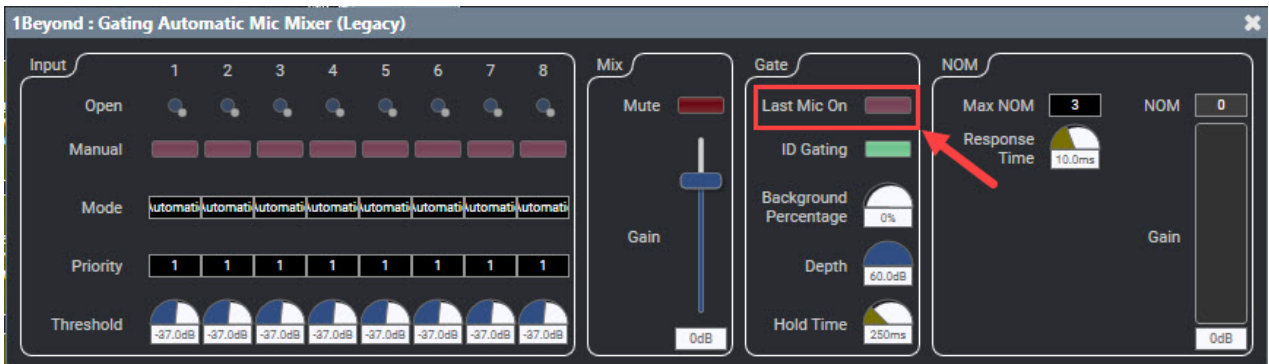

- In the mixer block settings window, select a **Threshold** dial. Then, type -35 on the keyboard to set the **Threshold** level to **-35 dB**. Perform this step on each channel's **Threshold**.

**NOTE:** Adjust the **-35 dB** value if necessary for correct gating behavior.

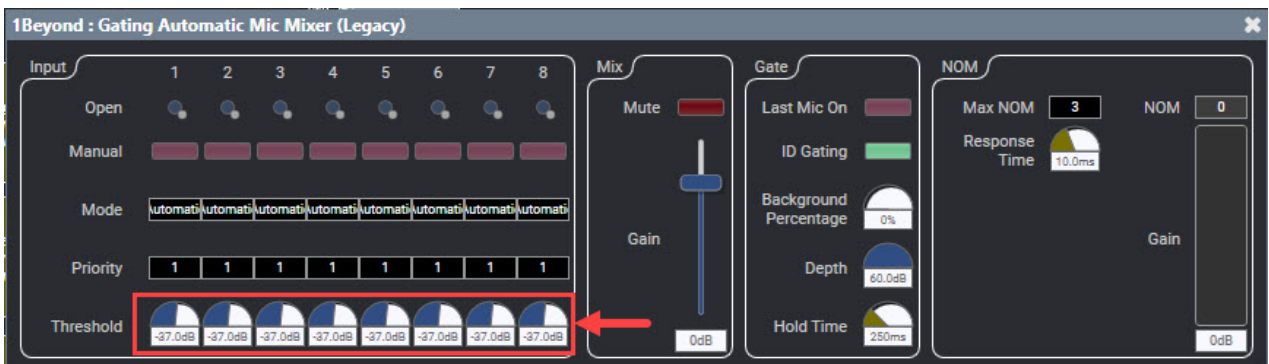

## AEC Reference

If a ceiling array microphone is in the room, an AEC (Acoustic Echo Cancellation) reference must be sent for it. If there are multiple ceiling array microphones, ensure that an AEC reference is sent for each ceiling array microphone. For more information about ceiling array microphones, refer to [Microphone Device Configuration on page 67](#)

### AEC Reference Example

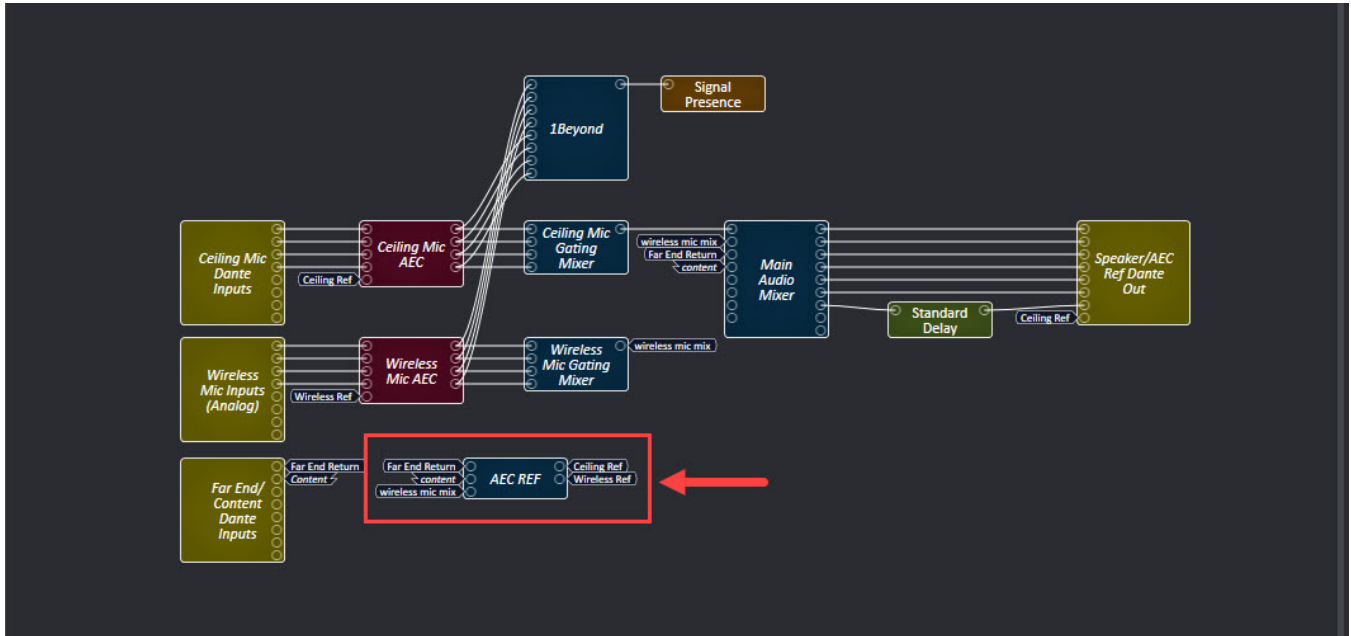

## Delay Block

A delay block is required in the project for the audio to properly sync with the video output from Automate VX. To add and configure a delay block into the project:

1. In the **Schematic Elements** menu, click and hold the left mouse button on **Delay**. Then, drag **Delay** into the project and release the left mouse button. This adds a **Standard Delay** block to the project.

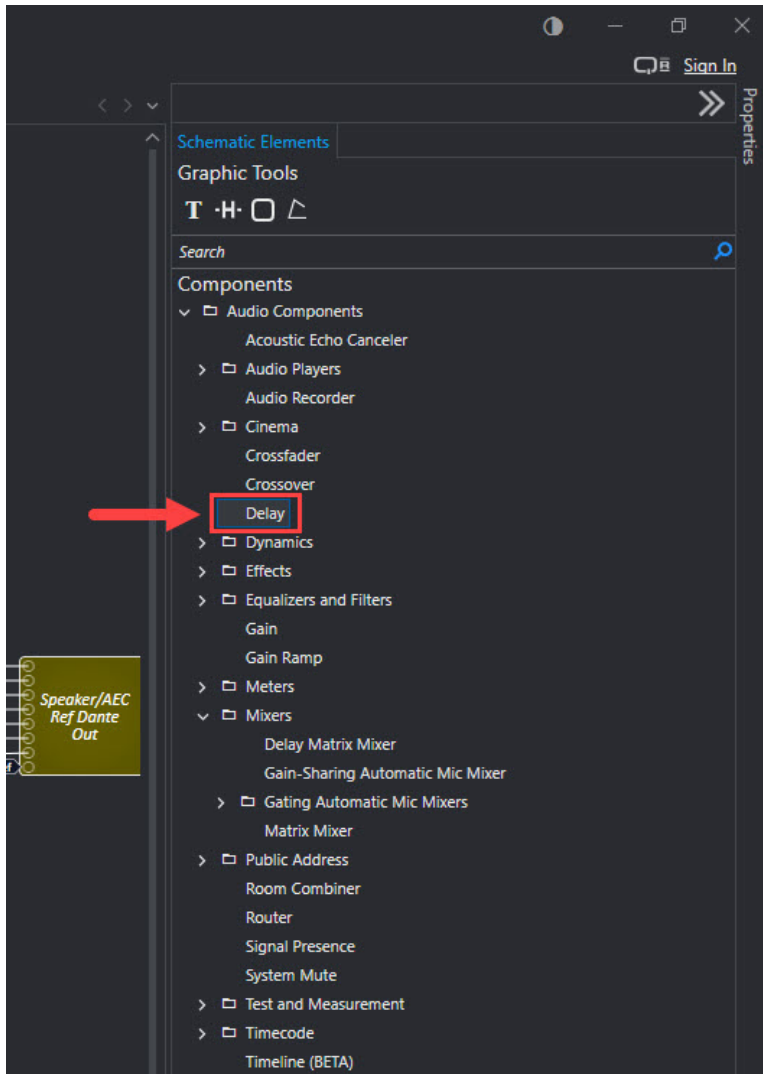

### Delay Block

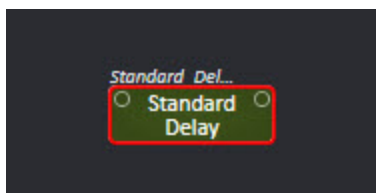

2. Select the **Standard Delay** block to open the mixer block settings window.

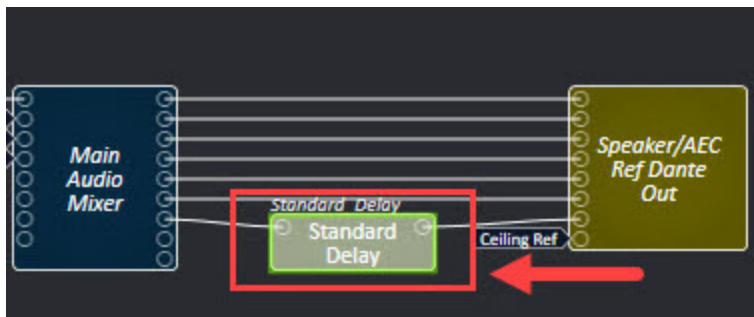

3. Select **File** in the top left corner of the software screen. Then, select **Emulate**.

**NOTE:** Alternately, press the **F6** button on the keyboard to activate **Emulate**.

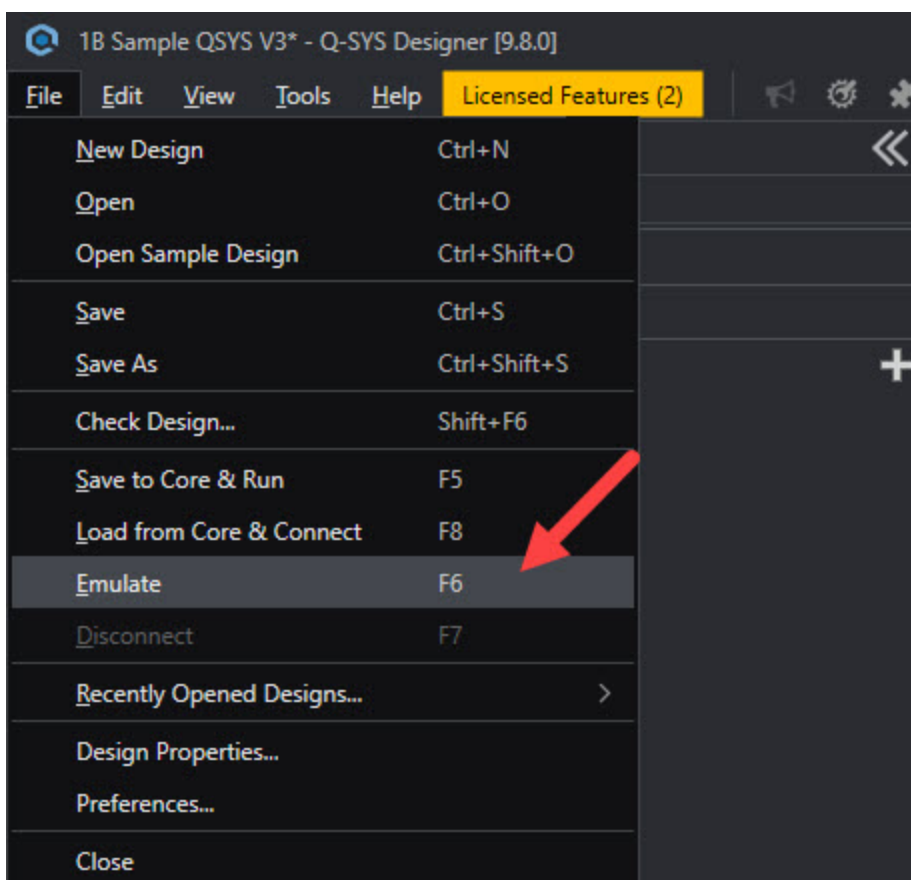

- In the mixer block settings window, select the **Delay** dial. Then, type 400 on the keyboard to set the **Delay** to **400 ms**. This ensures that the audio syncs with the Automate VX video.

**NOTE:** If NDI cameras are used with Automate VX, the delay may need to be increased to 450ms. This is due to the added latency over the network. Test the video output from Automate VX with this value and adjust the delay accordingly to match the audio.

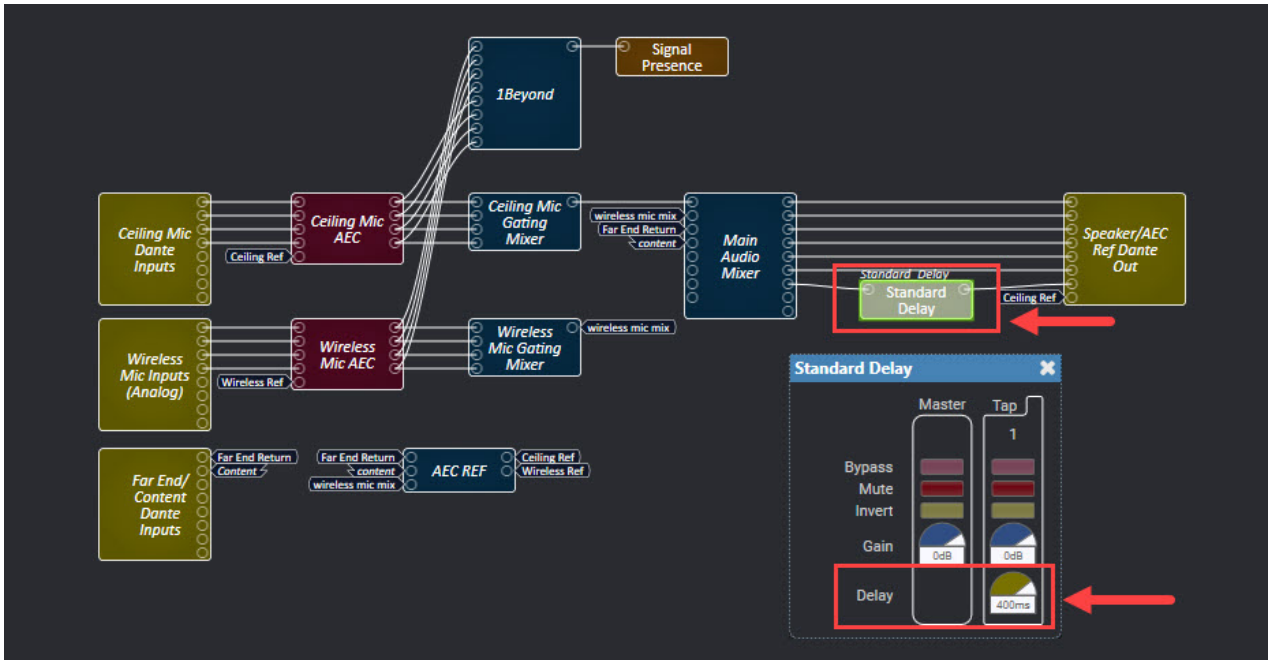

# Operation

The following procedures describe how to operate the basic functions of the Automate VX. For information on how to enter the web user interface, refer to [Access the Web Configuration Interface on page 33](#).

When the web user interface is opened, there are five main tabs that control the operation of the Automate VX system. The contents of these tabs are explained below.

**NOTE:** Before using these controls, ensure that the Automate VX is configured to the desired specifications. For more information on how to configure the Automate VX, refer to [System Configuration on page 100](#) and [Room Designer on page 32](#).

## Main Menu

Select the **Main** tab to view and perform common functions for the Automate VX.

### Main Menu Selections

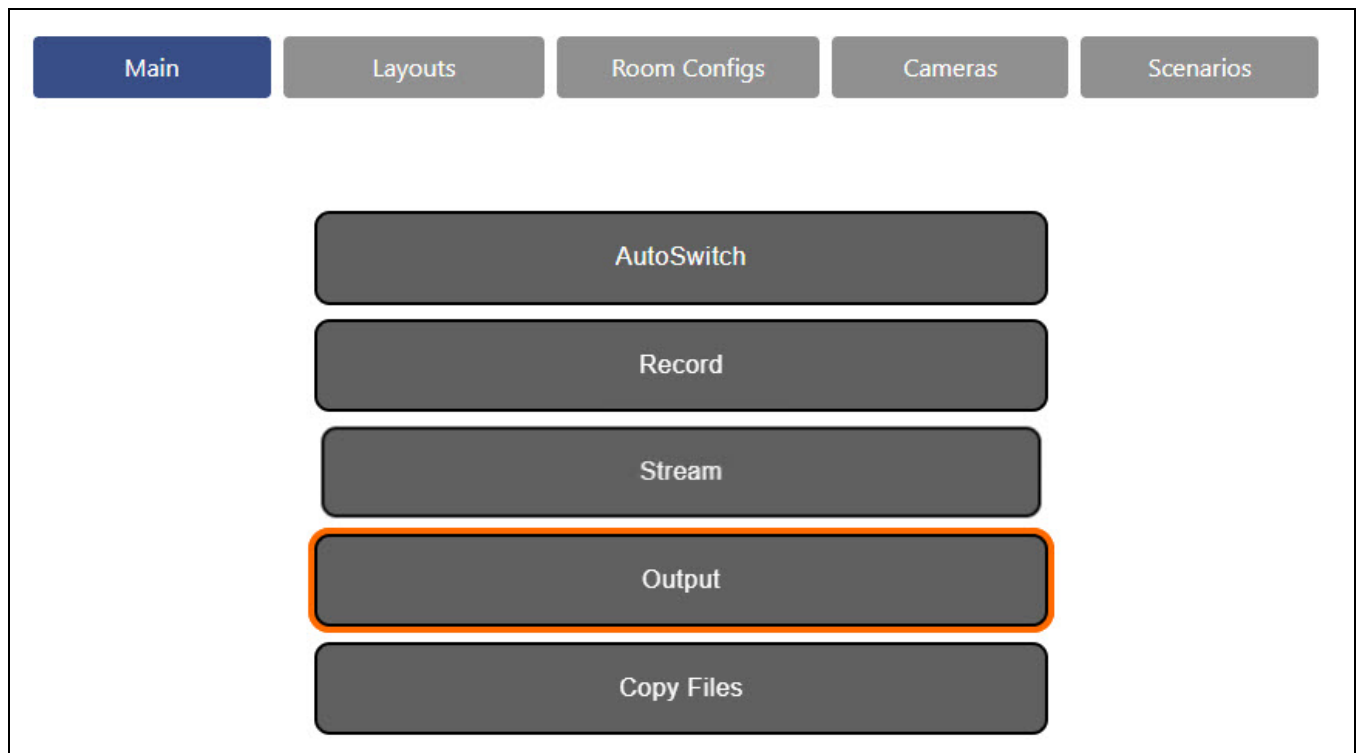

Select **AutoSwitch** to start and stop automated switching. AutoSwitching is the Automate VX using the Virtual Mic positions from Room Designer in conjunction with the Microphone Device to switch camera shots automatically. The software only communicates with Microphone Devices when **AutoSwitch** is activated. For more information on setting up a room layout in Room Designer to ensure the best AutoSwitching performance, refer to [Room Designer on page 32](#).

A green outline is shown around the button when AutoSwitching is turned on, and will initially go to the Default Shot of the configuration. With AutoSwitching on, the system output will switch automatically based on the active speaking participant. Select **AutoSwitch** again to stop automated switching.

**NOTE:** Automate VX may display a connection error when **AutoSwitch** is started and a microphone or camera cannot connect to the system. The error message will display the IP Address of any Microphone Devices or Camera Devices that it is unable to connect to.

#### AutoSwitch On

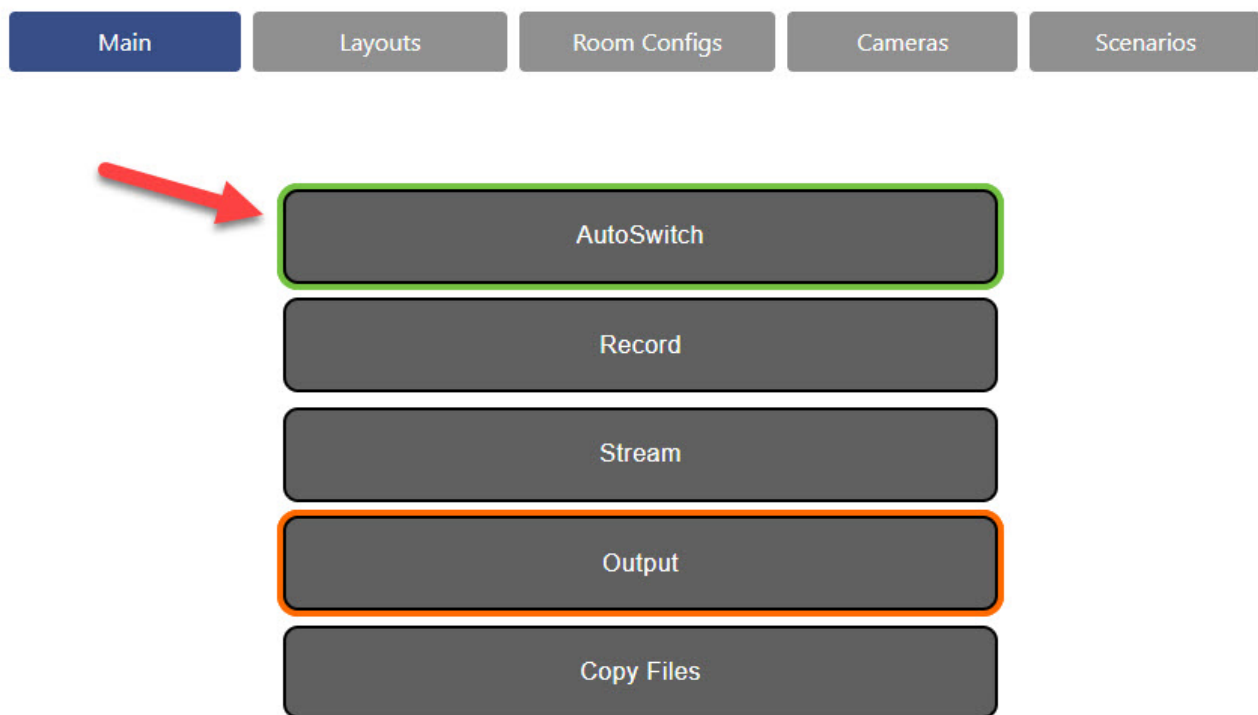

Select **Record** to start and stop a recording. A red outline is shown around the button when recording is turned on. Select **Record** again to stop recording.

- Recordings can be paused and resumed. This option is turned off by default. To turn on this option, refer to [General Settings on page 103](#).
- If ISO recording is turned on, separate video files for each input are created in addition to the main program recording.
- Program recordings and ISO recordings are saved to local storage at **D:\Recordings\VX**.

Select **Output** to start the camera feed of the Automate VX to output in Wirecast. For more information, refer to [Wirecast Configuration on page 132](#).

Select **Copy Files** to copy any recordings to the destination specified in the copy file settings.

Select **Stream** to start or stop a stream from Wirecast to an external streaming source, such as supported social media platforms. Streaming must be initially configured in Wirecast before this option can be used. For more information, refer to the [Wirecast documentation](#).

## Layouts Menu

Select the **Layouts** tab to view and select preset layouts for the Automate VX.

### Layouts Menu Selections

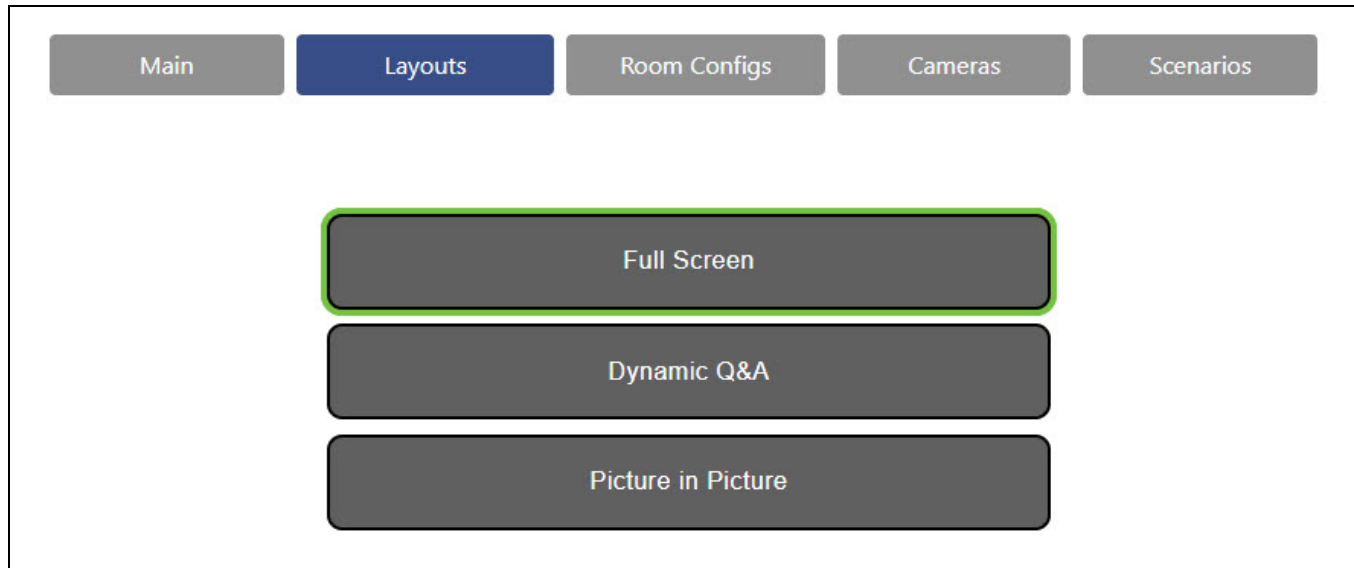

To change layouts during AutoSwitch mode, select the button that corresponds with the desired layout. The layout changes immediately, and the currently active layout is highlighted in green. The layouts are only used when AutoSwitch mode is enabled. For more information about configuring layouts, refer to [Layout Settings on page 105](#).



# Room Configs Menu

Select the **Room Configs** tab to view and select preset room configurations for the Automate VX.

## Room Configs Menu Selections

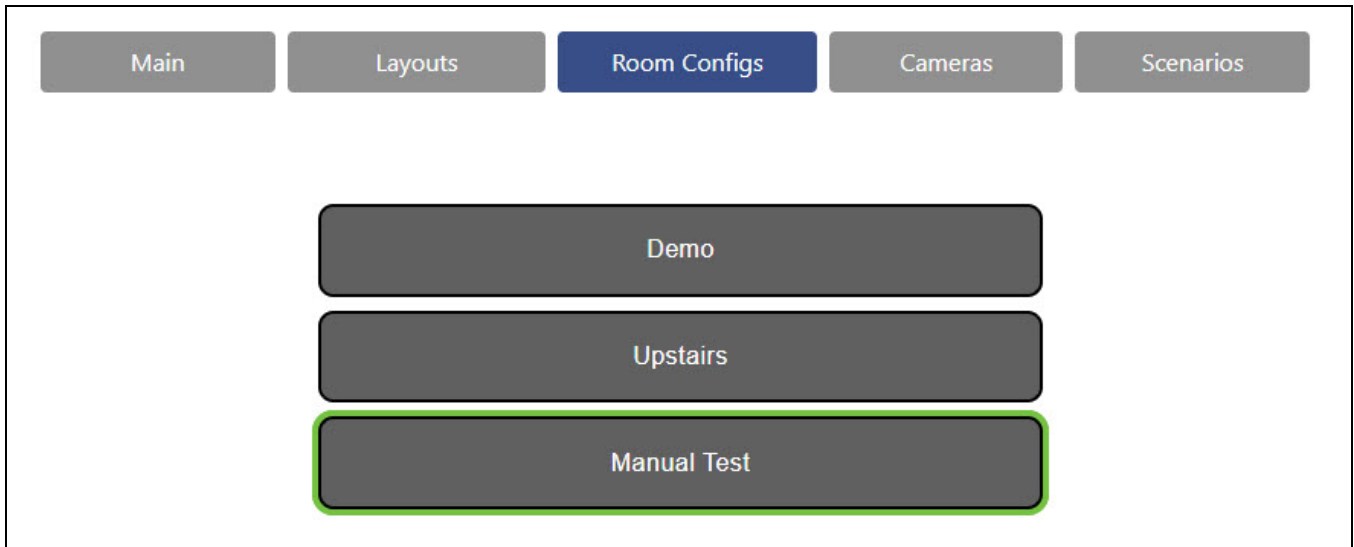

To change room configurations, select the button that corresponds with the desired room configuration. The room configuration changes immediately. For more information about room configurations, refer to [Room Configurations on page 110](#).

# Cameras Menu

Select the **Cameras** tab to view and select individual cameras for manual control.

## Cameras Menu Selections

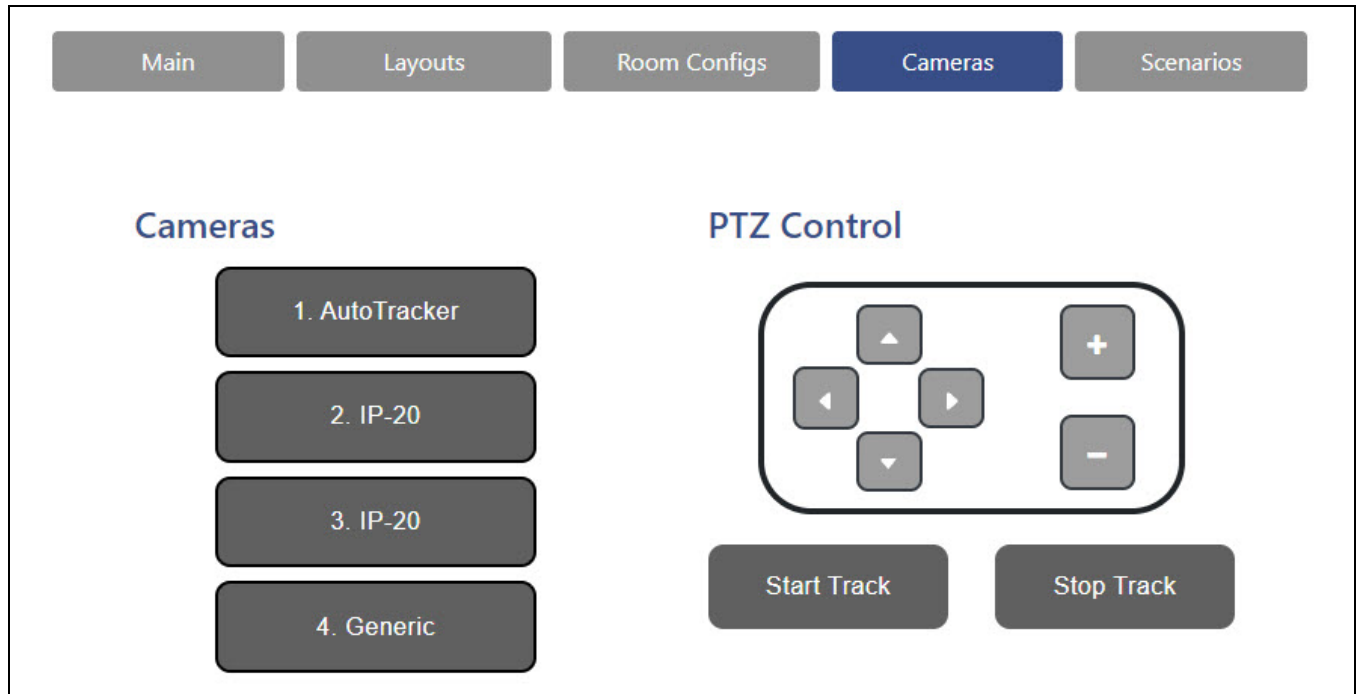

To select a camera for manual control, select a button under **Cameras** that corresponds to the desired camera. The live shot will change to the selected camera immediately.

Use the PTZ Control settings to manually change the direction and zoom of the selected camera. These PTZ movements will not save, and once AutoSwitching is enabled, it will override any inputs selected here. To change how cameras interact when AutoSwitching, refer to [Room Designer on page 32](#).

If using a camera that supports tracking, the **Start Track** and **Stop Track** buttons are used to start and stop tracking, respectively.

# Scenarios Menu

Select the **Scenarios** tab to view and select available scenarios to choose from.

## Scenarios Menu Selections

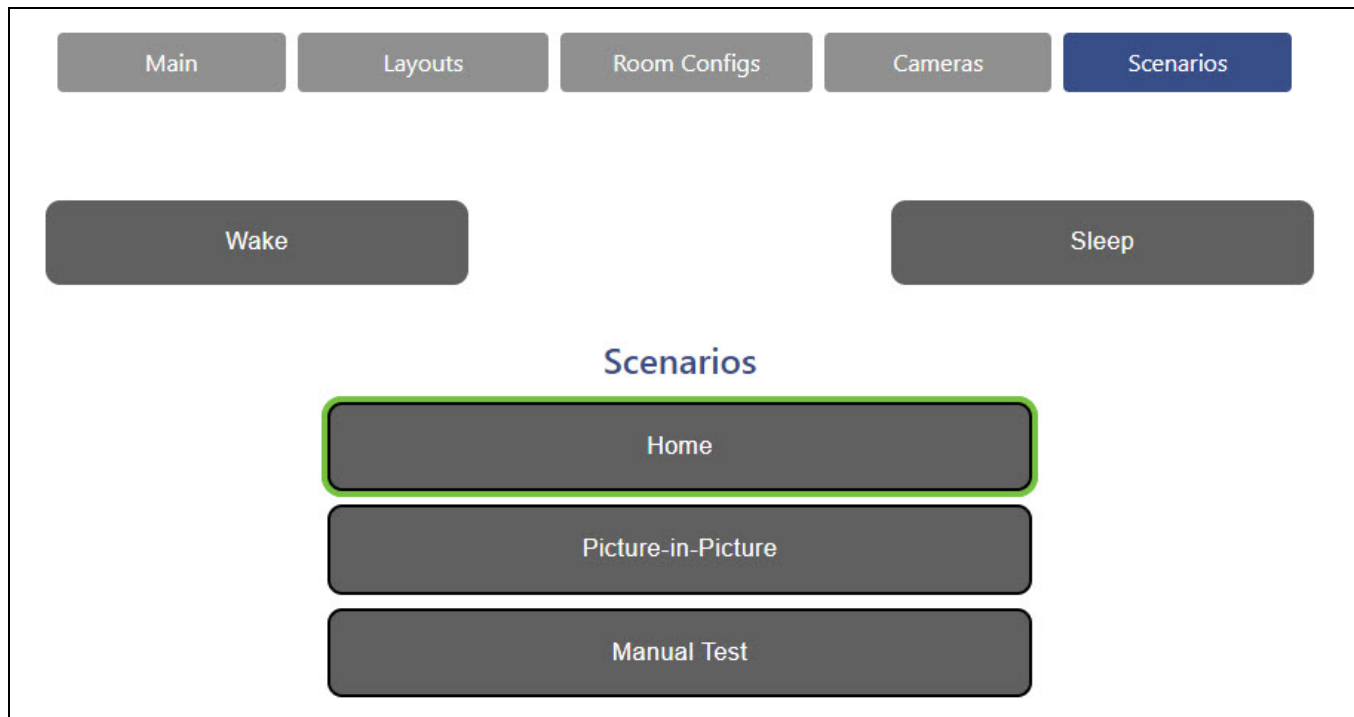

To change the current output to a scenario, select one of the created scenarios from the **Scenarios** list. This will make the current camera feed switch to the desired scenario. For more information about scenarios, refer to [System Configuration on page 100](#).

Select the **Wake** button to turn the system on from sleep mode. Enabling **Wake** will enable **Output**. It will also call the **Wake Action** defined in the **General** tab in the settings menu.

Select the **Sleep** button to put the system into sleep mode. Enabling Sleep will stop the Output, AutoSwitch, Recording, Streaming, and AutoTracking in any intelligent cameras. It will also call the Sleep Action defined in the **General** tab.

**NOTE:** To change what the Automate VX does for Sleep and Wake Actions, refer to [Sleep and Wake Settings on page 106](#).

# Resources

The following resources are provided for the Automate VX.

**NOTE:** You may need to provide your Crestron.com web account credentials when prompted to access some of the following resources.

## Crestron Support and Training

- [Crestron True Blue Support](#)
- [Crestron Resource Library](#)
- [Crestron Online Help \(OLH\)](#)
- [Crestron Training Institute \(CTI\) Portal](#)

## Product Certificates

To search for product certificates, refer to [support.crestron.com/app/certificates](https://support.crestron.com/app/certificates).

## Related Documentation

- [IV-SAM-VX2 Series Product Manual](#)
- [IV-SAM-VX Series Product Manual](#)
- [IV-CAM-P12/IV-CAM-P20/IV-CAM-I12/IV-CAM-I20 Series Product Manual](#)
- [IV-CAMPTZ-20 Series Product Manual](#)
- [IV-CAMPTZ-12 Series Product Manual](#)
- [IV-CAMA3-20 Series Product Manual](#)

