



TSS-70 Series
7 in. and 10.1 in. Room Scheduling Touch
Screens

Product Manual
Crestron Electronics, Inc.

The original language version of this document is U.S. English.
All other languages are a translation of the original document.

Regulatory Model: M201923002, M201923003

Crestron product development software is licensed to Crestron dealers and Crestron Service Providers (CSPs) under a limited nonexclusive, nontransferable Software Development Tools License Agreement. Crestron product operating system software is licensed to Crestron dealers, CSPs, and end-users under a separate End-User License Agreement. Both of these Agreements can be found on the Crestron website at www.crestron.com/legal/software_license_agreement.

The product warranty can be found at www.crestron.com/warranty.

The specific patents that cover Crestron products are listed online at www.crestron.com/legal/patents.

Certain Crestron products contain open source software. For specific information, please visit www.crestron.com/opensource.

Crestron, the Crestron logo, Crestron Fusion, Crestron Home, Crestron Toolbox, PinPoint, Rava, Smart Graphics, and XiO Cloud are either trademarks or registered trademarks of Crestron Electronics, Inc. in the United States and/or other countries. 2N is either a trademark or a registered trademark of 2N Telekomunikace in the United States and/or other countries. 22 Miles is either a trademark or a registered trademark of 22 Miles, Inc. in the United States and/or other countries. Appspace and the Appspace logo are either trademarks or registered trademarks of Appspace, Inc. in the United States and/or other countries. AskCody is either a trademark or a registered trademark of AskCody in the United States and/or other countries. Bluetooth is either a trademark or registered trademark of Bluetooth SIG, Inc. in the United States and/or other countries. EMS Software and the EMS logo are either trademarks or registered trademarks of EMS Software, LLC in the United States and/or other countries. Gingco.net is either a trademark or a registered trademark of Gingco.net in the United States and/or other countries. Envoy is either a trademark or a registered trademark of Envoy, Inc. in the United States and/or other countries. G Suite, Google, and Google Calendar are either trademarks or registered trademarks of Google, Inc. in the United States and/or other countries. Indoor Finders is either a trademark or a registered trademark of IntelliGroups, LLC in the United States and/or other countries. iOffice is either a trademark or a registered trademark of iOffice, LP in the United States and/or other countries. Kardham Digital is either a trademark or a registered trademark of Kardham Digital in the United States and/or other countries. Matrix Booking is either a trademark or a registered trademark of Matrix Booking in the United States and/or other countries. Active Directory, Microsoft, Microsoft Teams, and Office 365 are either trademarks or registered trademarks of Microsoft Corporation in the United States and/or other countries. New Wave Apps is either a trademark or a registered trademark of New Wave Apps in the United States and/or other countries. NFS is either a trademark or a registered trademark of NFS Technology Group in the United States and/or other countries. OfficeSpace is either a trademark or a registered trademark of OfficeSpace Software Inc. in the United States and/or other countries. Pepperdash is either a trademark or a registered trademark of Pepperdash Technology Corporation in the United States and/or other countries. Door Tablet is either a trademark or a registered trademark of Public.Class Limited in the United States and/or other countries. Korbyt is either a trademark or registered trademark of RMG Enterprise Solutions, Inc. in the United States and/or other countries. Robin and the Robin logo are either trademarks or registered trademarks of Robin Powered, Inc. in the United States and/or other countries. SharingCloud is either a trademark or a registered trademark of SharingCloud in the United States and/or other countries. Smartway2 is either a trademark or a registered trademark of Smartway2 Ltd. in the United States and/or other countries. Sonos is either a trademark or a registered trademark of Sonos, Inc. in the United States and/or other countries. Space Connect is either a trademark or a registered trademark of Spaceconnect Pty Ltd in the United States and/or other countries. SpacelQ is either a trademark or a registered trademark of Space IQ, LLC in the United States and/or other countries. Telelogos is either a trademark or a registered trademark of Telelogos SAS in the United States and/or other countries. EventBoard, Teem, and the Teem logo are either trademarks or registered trademarks of Teem, LLC in the United States and/or other countries. Zoom and Zoom Rooms are either trademarks or registered trademarks of Zoom Video Communications, Inc. in the United States and/or other countries. Other trademarks, registered trademarks, and trade names may be used in this document to refer to either the entities claiming the marks and names or their products. Crestron disclaims any proprietary interest in the marks and names of others. Crestron is not responsible for errors in typography or photography.

©2023 Crestron Electronics, Inc.

Contents

- Overview** **1**
- Features 2
 - TSS-770 Features 3
 - TSS-770-T Features 7
 - TSS-770-Z Features 11
 - TSS-1070 Features 15
 - TSS-1070-T Features 19
 - TSS-1070-Z Features 23
- Physical Description 27
- Specifications** **28**
- TSS-770 Specifications 29
 - Product Specifications 29
 - Dimension Drawings 32
- TSS-770-T Specifications 34
 - Product Specifications 34
 - Dimension Drawings 37
- TSS-770-Z Specifications 39
 - Product Specifications 39
 - Dimension Drawings 42
- TSS-1070 Specifications 44
 - Product Specifications 44
 - Dimension Drawings 47
- TSS-1070-T Specifications 49
 - Product Specifications 49
 - Dimension Drawings 52
- TSS-1070-Z Specifications 53
 - Product Specifications 53
 - Dimension Drawings 56
- Installation** **57**
- Install the Mounting Bracket 57
 - Electrical Box Mounting 58
 - Drywall Mounting 59
- Install the Security Bracket (Optional) 59
- Connect the Touch Screen 60
- Mount the Touch Screen 61
- Configure the Touch Screen 62
 - Access the Device Setup Screens 63
 - Access the Web Configuration Interface 63
 - Create an Admin Account 64
 - Set the Time Zone 65

Select an Application	65
Configure Microsoft Teams Panels	66
Configure the Zoom Rooms Application	68
Configuration	70
Local Configuration	72
Access the Setup Screens	72
Ethernet Setup	73
Application Selection	80
Wi-Fi Setup	81
Bluetooth Beacon	88
Virtual Toolbar	89
Diagnostics & Advanced	91
About	96
Web Configuration	97
Actions Menu	98
Status	101
Settings	106
Security	123
802.1x Configuration	131
Application Selection	134
Operation	136
Resources	138
Crestron Support and Training	138
Programmer and Developer Resources	138
Related Documentation	138

Overview

The Crestron® [TSS-770](#) and [TSS-1070](#) are wall mount touch screens designed specifically for room scheduling applications. The touch screens install near the entrance of a meeting room or huddle space to provide a clear indication of the room availability and schedule, and they integrate seamlessly with a variety of popular scheduling services.

NOTE: The TSS-770 and TSS-1070 are functionally similar. For simplicity within this documentation, the term "touch screen" is used except where otherwise noted.

Crestron offers the following variations for its standard touch screen models. Certain settings described in this document are not applicable to these models.

- The [TSS-770-T](#) and [TSS-1070-T](#) series touch screens are designed to specifically run the Microsoft Teams® Panels scheduling application.
- The [TSS-770-Z](#) and [TSS-1070-Z](#) series touch screens are designed to specifically run the Zoom Rooms® scheduling application.

Features

Refer to the following sections for more information on the features provided by various TSS-70 Series models.

- [TSS-770 Features on page 3](#)
- [TSS-770-T Features on page 7](#)
- [TSS-770-Z Features on page 11](#)
- [TSS-1070 Features on page 15](#)
- [TSS-1070-T Features on page 19](#)
- [TSS-1070-Z Features on page 23](#)

TSS-770 Features

Crestron® TSS-770 series touch screens are designed to enhance and simplify room scheduling across an enterprise. The TSS-770 installs near a meeting room or huddle space to provide a clear indication of its availability and scheduling while integrating seamlessly with a variety of popular scheduling services.

The TSS-770 is also sold as part of a kit that includes one [TSW-770-LB](#) series room availability light bar, providing a complete room scheduling solution out of the box.

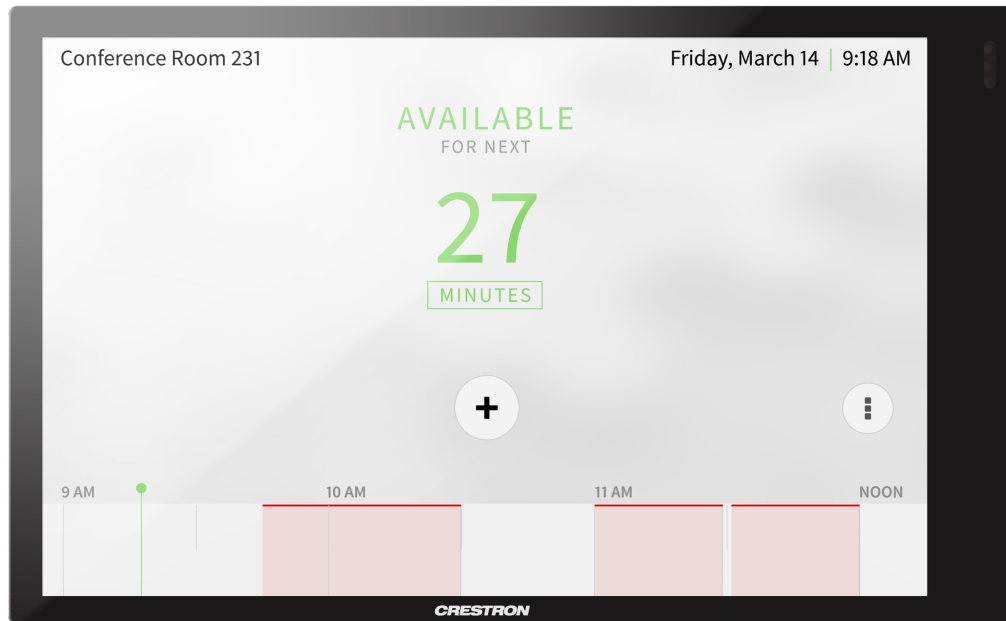

Key features include:

- Touch screen designed specifically for enterprise room scheduling applications
- Delivers a superior and cost-effective alternative to consumer tablet devices
- Integrates directly with various room scheduling services
- 7 in. (178 mm) widescreen capacitive touch screen display
- Standard U.S., U.K., and European electrical box installation with additional mounting options available
- Single wire Ethernet connection with PoE or PoE+ power
- Wi-Fi® network connectivity
- Dual USB 2.0 ports for room availability accessories
- Enterprise grade security and authentication
- Choice of white or black smooth finish

Crestron Room Scheduling App

The native Crestron Scheduling app helps to maximize productivity and manage usage for meeting spaces. If desired, the room can be reserved on the spot for an ad hoc meeting. A [CEN-ODT-C-POE](#)

occupancy sensor (sold separately) can also be paired to the touch screen, allowing for occupancy status to be reported instantly to the scheduling app for no-shows and unscheduled room usage.¹

Crestron room scheduling also offers three levels of customization—ranging from simply configuring settings in the web user interface to modifying the application source code for a completely unique appearance—depending on the needs of an enterprise.

Running the Crestron Scheduling App, the TSS-770 integrates directly with [Crestron Fusion®](#) software, Microsoft Exchange Server® software (for users of Outlook® software and Office 365® software), the Google Calendar™ calendaring app (including G Suite™ software), CollegeNET® 25Live® scheduling software, or Ad Astra® software. IBM® Notes® software is also supported through a Crestron Fusion on-premises server.

Third-Party Scheduling Apps

The TSS-770 includes support various third-party scheduling applications. New providers are made available via firmware updates. Whatever provider you choose, setup is as simple as connecting the touch screen to the network and choosing an app from the web-based setup menu or built-in setup screens. The selected app downloads from the cloud and installs on the touch screen without any programming or control system required.^{1,2,3}

Built for Enterprise Scheduling

The TSS-770 is engineered to meet the demands of a corporate office, conference center, or education environment. Its 7 in. (178 mm) capacitive display provides an intuitive user interface. The UI can be customized and branded with your choice of background images and logos.¹ A larger 10.1 in. (257 mm) version ([TSS-1070](#) series) is also available.

- **Functional:** The TSS-770 provides a compact unit for scheduling applications that mounts over a standard electrical box or cutout. The TSS-770 offers high-speed Ethernet and PoE/PoE+ connectivity, or, for deployments without access to Ethernet, can connect to the network over Wi-Fi® communications via a local wireless access point (WAP).
- **Versatile:** Crestron offers a variety of mounting options for mounting the TSS-770 to drywall, masonry, glass, mullions, and other surfaces. Optional light bar and hallway sign accessories are available to increase the visibility of the room availability status.
- **Reliable:** The TSS-770 is purpose-built for permanent installation and years of reliable 24/7 operation in a commercial environment. To ensure the latest features are available, the TSS-770 checks nightly for app updates and loads the latest version automatically.
- **Secure:** The TSS-770 employs enterprise-grade networking with robust security features such as 802.1X authentication, TLS encryption, HTTPS connectivity, and Active Directory® service integration. These features protect your network against service interruptions and malicious intrusions.
- **Manageable:** The TSS-770 features cloud-based provisioning and management, which streamlines configuring, monitoring, and updating the touch screen on the network. The TSS-770 also supports SNMP, so it can be monitored by your IT administrator.

Status Indicator Options

The TSS-770 provides dual high-speed USB 2.0 ports for connecting Crestron room scheduling accessories (sold separately) to the touch screen that enhance an enterprise room scheduling solution.

NOTE: The touch screen supports the use of a single light bar or status indicator accessory only. The [RFID-USB](#) card reader accessory can be connected to the second USB port.

- The optional [TSW-770-LB](#) series light bars provide a 180° visual indication of a room's availability status, illuminating green if the room is available and red when reserved, with options for custom color mixing and programming.⁴
- The optional [SSW-EL](#) and [SSC-EL](#) series hallway signs feature a two sided acrylic sign face that can be custom engraved with the room name or number. The [SIW-100](#) offers a lower profile wall mount status indicator.⁴

Bluetooth Beacon

The built-in Bluetooth® proximity detection beacon works with the Crestron Go App and Crestron App to determine when a mobile device is in or near the same room as the beacon, and signals the mobile app to automatically display the appropriate controls and information for the room.⁵

Proximity Sensor and Brightness Controls

The TSS-770 provides a built-in proximity sensor that wakes the screen without requiring any user interaction, and automatic brightness controls ensure optimal visibility under varying lighting conditions.

Power over Ethernet

PoE (Power over Ethernet) eliminates the need for a local power supply or any dedicated power wiring. [Crestron PoE switches](#) (sold separately) offer a total networking solution with built-in PoE for multiple touch screens. A PoE Injector ([PWE-4803RU](#), sold separately) is also available to support a single touch screen.

NOTE: Refer to the "Power" specifications for more details.

XiO Cloud Service

The TSS-770 is compatible with the XiO Cloud® service, which remotely provisions, monitors, and manages Crestron devices across an enterprise or an entire client base. Built on the Microsoft® Azure® software platform and utilizing Microsoft's Azure IoT Hub technology, XiO Cloud enables installers and IT managers to deploy and manage thousands of devices simultaneously. Unlike other virtual machine-based cloud solutions, Azure services provide unlimited scalability. For more information, visit www.crestron.com/xiocloud.

Wall Mount Options

Using the bracket provided, the TSS-770 is easily installed over a 2-gang or 3-gang US electrical box, or a 2-gang European or UK electrical box. A security latch option is included to deter unauthorized removal of the touch screen.

Additional wall mounting options are available using the optional [TSW-UMB-70](#) universal mounting bracket, [TSW-UMB-70-PMK](#) preconstruction mounting kit, and [TSW-UMB-70-BBI](#) back box (sold separately).⁶

Optional Mounting Accessories

The TSS-770 supports numerous optional mounting accessories (sold separately) that allow the touch screen to be installed in all kinds of installations:

- The [TSW-770-MSMK](#) multisurface mount kit allows a TSS-770 touch screen to be mounted directly to virtually any flat surface, which is ideal for mounting at a meeting space entrance for room scheduling applications.
- The [TSW-770/1070-MUMK](#) allows the touch screen to be attached to the mullion of an interior glass wall, window, or partition.
- The [TSW-770/1070-RMB-1](#) and [TSW-770/1070-RMB-2](#) retrofit mounting brackets allow for retrofit installations in place of an older Crestron touch screen (APAD, CT-1000, LC-1000, TPS-4L, or TPS-2000L) without having to tear out the old mounting hardware or patch the wall.
- The [TSW-770-FP](#) face plate hides the electrical box from view when replacing a TSW-760 or TSS-7 series touch screen with a TSS-770 series touch screen.
- Though not typical for most scheduling applications, the [TSW-570/770-RMK-1](#) rack mount kit can be used to mount the touch screen into a 19 in. rack. When installed, the touch screen occupies three rack spaces.

The TSS-770 is also compatible with Wall-Smart® flush wall mount products via a partnership with Crestron. For more information on supported Wall-Smart hardware, click [here](#).

Notes:

1. Actual functionality and on-screen appearance varies based on which scheduling app is in use and how the app is set up. The functionality described in this spec sheet generally refers to the Crestron Scheduling app. Each third-party provider determines the functionality and appearance of their respective app. Additionally, CollegeNET® 25Live® scheduling software and Ad Astra™ software do not support scheduling ad hoc meetings from the touch screen. Refer to each provider's website for more information.
2. Refer to the firmware release notes for a list of all scheduling apps that are supported by that firmware release.
3. Additional subscriptions and/or licenses may be required. Refer to each provider's website for details about the capabilities and requirements of its scheduling application and services. Third-party apps typically run on the TSS-770 as they do on a tablet device. The TSS-770 runs only one app, which is selected at setup. Only the apps approved and delivered by Crestron can run on the TSS-770. The TSS-770 cannot be interfaced with a control system and cannot be custom programmed for any other functionality. An internet connection is required.
4. The TSS-770 may be powered by either a PoE or PoE+ power source when a light bar or hallway sign is connected. Refer to the Accessories section for a list of all available options. Refer to each accessory's spec sheet for further information.
5. Bluetooth technology is used solely for proximity detection and does not transmit or receive any control, multimedia, or personal data. Crestron Bluetooth beacons are only visible to Bluetooth enabled devices that are specifically programmed and configured to work with them.
6. The TSW-UMB-70 is also compatible with older TSW-UMB-PMK series preconstruction mounting kits and TSW-BBI series back boxes, allowing the TSS-770 to be installed in place of a previous generation touch screen.

TSS-770-T Features

Crestron® TSS-770-T series touch screens are designed to enhance and simplify room scheduling across an enterprise. The TSS-770-T installs near a meeting room or huddle space to provide a clear indication of its availability and scheduling while integrating seamlessly with the Microsoft Teams® Panels scheduling application. Support for additional room scheduling services is also provided.

The TSS-770-T is sold as part of a kit that includes one [TSW-770-LB](#) series room availability light bar, providing a complete room scheduling solution out of the box.



Key features include:

- Touch screen designed specifically to run the Microsoft Teams® Panels scheduling application
- Delivers a superior and cost-effective alternative to consumer tablet devices
- 7 in. (178 mm) widescreen capacitive touch screen display
- Standard U.S., U.K., and European electrical box installation with additional mounting options available
- Single wire Ethernet connection with PoE or PoE+ power
- Wi-Fi® network connectivity
- Dual USB 2.0 ports for room availability accessories
- Enterprise grade security and authentication
- Choice of white or black smooth finish

Microsoft Teams Panels

The native Microsoft Teams Panels scheduling application helps to maximize productivity and manage usage for meeting spaces via Microsoft Teams. The touch screen can be configured to use the Microsoft Teams scheduling calendar, allowing users to book meetings through their Microsoft Teams account. If desired, the room can be reserved on the spot for an ad hoc meeting.^{1,2}

NOTE: For more information on Microsoft Teams Panels, refer to <https://docs.microsoft.com/en-us/microsoftteams/devices/teams-panels>.

Built for Enterprise Scheduling

The TSS-770-T is engineered to meet the demands of a corporate office, conference center, or education environment. Its 7 in. (178 mm) capacitive display provides an intuitive user interface. A larger 10.1 in. (257 mm) version ([TSS-1070](#) series) is also available.

- **Functional:** The TSS-770-T provides a compact unit for scheduling applications that mounts over a standard electrical box or cutout. The TSS-770-T offers high-speed Ethernet and PoE/PoE+ connectivity, or, for deployments without access to Ethernet, can connect to the network over Wi-Fi® communications via a local wireless access point (WAP).
- **Versatile:** Crestron offers a variety of mounting options for mounting the TSS-770-T to drywall, masonry, glass, mullions, and other surfaces. Optional light bar and hallway sign accessories are available to increase the visibility of the room availability status.
- **Reliable:** The TSS-770-T is purpose-built for permanent installation and years of reliable 24/7 operation in a commercial environment. To ensure the latest features are available, the TSS-770-T checks nightly for app updates and loads the latest version automatically.
- **Secure:** The TSS-770-T employs enterprise-grade networking with robust security features such as 802.1X authentication, TLS encryption, HTTPS connectivity, and Active Directory® service integration. These features protect your network against service interruptions and malicious intrusions.
- **Manageable:** The TSS-770-T features cloud-based provisioning and management, which streamlines configuring, monitoring, and updating the touch screen on the network. The TSS-770-T also supports SNMP, so it can be monitored by your IT administrator.

Status Indicator Options

The TSS-770-T provides dual high-speed USB 2.0 ports for connecting Crestron room scheduling accessories (sold separately) to the touch screen that enhance an enterprise room scheduling solution.

NOTE: The touch screen supports the use of a single light bar or status indicator accessory only. The [RFID-USB](#) card reader accessory can be connected to the second USB port.

- The included [TSW-770-LB](#) series light bar provides a 180° visual indication of a room's availability status, illuminating green if the room is available and red when reserved, with options for custom color mixing and programming.³
- The optional [SSW-EL](#) and [SSC-EL](#) series hallway signs feature a two sided acrylic sign face that can be custom engraved with the room name or number. The [SIW-100](#) offers a lower profile wall mount status indicator.³

Bluetooth Beacon

The built-in Bluetooth® proximity detection beacon works with the Crestron Go App and Crestron App to determine when a mobile device is in or near the same room as the beacon, and signals the mobile app to automatically display the appropriate controls and information for the room.⁴

Proximity Sensor and Brightness Controls

The TSS-770-T provides a built-in proximity sensor that wakes the screen without requiring any user interaction, and automatic brightness controls ensure optimal visibility under varying lighting conditions.

Power over Ethernet

PoE (Power over Ethernet) eliminates the need for a local power supply or any dedicated power wiring. [Crestron PoE switches](#) (sold separately) offer a total networking solution with built-in PoE for multiple touch screens. A PoE Injector ([PWE-4803RU](#), sold separately) is also available to support a single touch screen.

NOTE: Refer to the "Power" specifications for more details.

XiO Cloud Service

The TSS-770-T is compatible with the XiO Cloud® service, which remotely provisions, monitors, and manages Crestron devices across an enterprise or an entire client base. Built on the Microsoft® Azure® software platform and utilizing Microsoft's Azure IoT Hub technology, XiO Cloud enables installers and IT managers to deploy and manage thousands of devices simultaneously. Unlike other virtual machine-based cloud solutions, Azure services provide unlimited scalability. For more information, visit www.crestron.com/xiocloud.

Wall Mount Options

Using the bracket provided, the TSS-770-T is easily installed over a 2-gang or 3-gang US electrical box, or a 2-gang European or UK electrical box. A security latch option is included to deter unauthorized removal of the touch screen.

Additional wall mounting options are available using the optional [TSW-UMB-70](#) universal mounting bracket, [TSW-UMB-70-PMK](#) preconstruction mounting kit, and [TSW-UMB-70-BBI](#) back box (sold separately).⁵

Optional Mounting Accessories

The TSS-770-T supports numerous optional mounting accessories (sold separately) that allow the touch screen to be installed in all kinds of installations:

- The [TSW-770-MSMK](#) multisurface mount kit allows a TSS-770-T touch screen to be mounted directly to virtually any flat surface, which is ideal for mounting at a meeting space entrance for room scheduling applications.
- The [TSW-770/1070-MUMK](#) allows the touch screen to be attached to the mullion of an interior glass wall, window, or partition.
- The [TSW-770/1070-RMB-1](#) and [TSW-770/1070-RMB-2](#) retrofit mounting brackets allow for retrofit installations in place of an older Crestron touch screen (APAD, CT-1000, LC-1000, TPS-4L, or TPS-2000L) without having to tear out the old mounting hardware or patch the wall.

- Though not typical for most scheduling applications, the [TSW-570/770-RMK-1](#) rack mount kit can be used to mount the touch screen into a 19 in. rack. When installed, the touch screen occupies three rack spaces.

Notes:

1. Microsoft determines the functionality and appearance of the Microsoft Teams room scheduling application. Refer to the Microsoft website for more information.
2. Additional subscriptions and/or licenses may be required. Refer to the Microsoft website for details about the capabilities and requirements of its scheduling application and services. The TSS-770-T cannot be interfaced with a control system and cannot be custom programmed for any other functionality. An internet connection is required.
3. The TSS-770-T may be powered by either a PoE or PoE+ power source when a light bar or hallway sign is connected. Refer to the Accessories section for a list of all available options. Refer to each accessory's spec sheet for further information.
4. Bluetooth technology is used solely for proximity detection and does not transmit or receive any control, multimedia, or personal data. Crestron Bluetooth beacons are only visible to Bluetooth enabled devices that are specifically programmed and configured to work with them.
5. The TSW-UMB-70 is also compatible with older TSW-UMB-PMK series preconstruction mounting kits and TSW-BBI series back boxes, allowing the TSS-770-T to be installed in place of a previous generation touch screen.

TSS-770-Z Features

Crestron® TSS-770-Z series touch screens are designed to enhance and simplify room scheduling across an enterprise. The TSS-770-Z installs near a meeting room or huddle space to provide a clear indication of its availability and scheduling while integrating seamlessly with the Zoom Rooms® scheduling application. Support for additional room scheduling services is also provided.

The TSS-770-Z is sold as part of a kit that includes one [TSW-770-LB](#) series room availability light bar, providing a complete room scheduling solution out of the box.



Key features include:

- Touch screen designed specifically to run the Zoom Rooms® scheduling application
- Delivers a superior and cost-effective alternative to consumer tablet devices
- 7 in. (178 mm) widescreen capacitive touch screen display
- Standard U.S., U.K., and European electrical box installation with additional mounting options available
- Single wire Ethernet connection with PoE or PoE+ power
- Wi-Fi® network connectivity
- Dual USB 2.0 ports for room availability accessories
- Enterprise grade security and authentication
- Choice of white or black smooth finish

Zoom Rooms Application

The native Zoom Rooms scheduling application helps to maximize productivity and manage usage for meeting spaces. The touch screen can be configured to use the Zoom Rooms scheduling calendar, allowing users to check meeting room availability and book meetings through their organization's Zoom Rooms deployment. If desired, the room can be reserved on the spot for an ad hoc or future meeting^{1,2}

A provided USB drive boots the touch screen directly into Zoom Rooms scheduling mode for fast deployment.

NOTE: For more information on Zoom Rooms scheduling, refer to <https://support.zoom.us/hc/en-us/articles/115003336806-Using-Zoom-Rooms-scheduling-display>.

Built for Enterprise Scheduling

The TSS-770-Z is engineered to meet the demands of a corporate office, conference center, or education environment. Its 7 in. (178 mm) capacitive display provides an intuitive user interface. A larger 10.1 in. (257 mm) version ([TSS-1070](#) series) is also available.

- **Functional:** The TSS-770-Z provides a compact unit for scheduling applications that mounts over a standard electrical box or cutout. The TSS-770-Z offers high-speed Ethernet and PoE/PoE+ connectivity, or, for deployments without access to Ethernet, can connect to the network over Wi-Fi® communications via a local wireless access point (WAP).
- **Versatile:** Crestron offers a variety of mounting options for mounting the TSS-770-Z to drywall, masonry, glass, mullions, and other surfaces. Optional light bar and hallway sign accessories are available to increase the visibility of the room availability status.
- **Reliable:** The TSS-770-Z is purpose-built for permanent installation and years of reliable 24/7 operation in a commercial environment. To ensure the latest features are available, the TSS-770-Z checks nightly for app updates and loads the latest version automatically.
- **Secure:** The TSS-770-Z employs enterprise-grade networking with robust security features such as 802.1X authentication, TLS encryption, HTTPS connectivity, and Active Directory® service integration. These features protect your network against service interruptions and malicious intrusions.
- **Manageable:** The TSS-770-Z features cloud-based provisioning and management, which streamlines configuring, monitoring, and updating the touch screen on the network. The TSS-770-Z also supports SNMP, so it can be monitored by your IT administrator.

Status Indicator Options

The TSS-770-Z provides dual high-speed USB 2.0 ports for connecting Crestron room scheduling accessories (sold separately) to the touch screen that enhance an enterprise room scheduling solution.

NOTE: The touch screen supports the use of a single light bar or status indicator accessory only. The [RFID-USB](#) card reader accessory can be connected to the second USB port.

- The included [TSW-770-LB](#) series light bar provides a 180° visual indication of a room's availability status, illuminating green if the room is available and red when reserved, with options for custom color mixing and programming.³

- The optional [SSW-EL](#) and [SSC-EL](#) series hallway signs feature a two sided acrylic sign face that can be custom engraved with the room name or number. The [SIW-100](#) offers a lower profile wall mount status indicator.³

Bluetooth Beacon

The built-in Bluetooth® proximity detection beacon works with the Crestron Go App and Crestron App to determine when a mobile device is in or near the same room as the beacon, and signals the mobile app to automatically display the appropriate controls and information for the room.

Proximity Sensor and Brightness Controls

The TSS-770-Z provides a built-in proximity sensor that wakes the screen without requiring any user interaction, and automatic brightness controls ensure optimal visibility under varying lighting conditions.

Power over Ethernet

PoE (Power over Ethernet) eliminates the need for a local power supply or any dedicated power wiring. [Crestron PoE switches](#) (sold separately) offer a total networking solution with built-in PoE for multiple touch screens. A PoE Injector ([PWE-4803RU](#), sold separately) is also available to support a single touch screen.

NOTE: Refer to the "Power" specifications for more details.

XiO Cloud Service

The TSS-770-Z is compatible with the XiO Cloud® service, which remotely provisions, monitors, and manages Crestron devices across an enterprise or an entire client base. Built on the Microsoft® Azure® software platform and utilizing Microsoft's Azure IoT Hub technology, XiO Cloud enables installers and IT managers to deploy and manage thousands of devices simultaneously. Unlike other virtual machine-based cloud solutions, Azure services provide unlimited scalability. For more information, visit www.crestron.com/xiocloud.

Wall Mount Options

Using the bracket provided, the TSS-770-Z is easily installed over a 2-gang or 3-gang US electrical box, or a 2-gang European or UK electrical box. A security latch option is included to deter unauthorized removal of the touch screen.

Additional wall mounting options are available using the optional [TSW-UMB-70](#) universal mounting bracket, [TSW-UMB-70-PMK](#) preconstruction mounting kit, and [TSW-UMB-70-BBI](#) back box (sold separately).⁵

Optional Mounting Accessories

The TSS-770-Z supports numerous optional mounting accessories (sold separately) that allow the touch screen to be installed in all kinds of installations:

- The [TSW-770-MSMK](#) multisurface mount kit allows a TSS-770-Z touch screen to be mounted directly to virtually any flat surface, which is ideal for mounting at a meeting space entrance for room scheduling applications.
- The [TSW-770/1070-MUMK](#) allows the touch screen to be attached to the mullion of an interior glass wall, window, or partition.

- The [TSW-770/1070-RMB-1](#) and [TSW-770/1070-RMB-2](#) retrofit mounting brackets allow for retrofit installations in place of an older Crestron touch screen (APAD, CT-1000, LC-1000, TPS-4L, or TPS-2000L) without having to tear out the old mounting hardware or patch the wall.
- Though not typical for most scheduling applications, the [TSW-570/770-RMK-1](#) rack mount kit can be used to mount the touch screen into a 19 in. rack. When installed, the touch screen occupies three rack spaces.

Notes:

1. Zoom determines the functionality and appearance of the Zoom Rooms® room scheduling application. Refer to the Zoom® website for more information.
2. Additional subscriptions and/or licenses may be required. Refer to the Zoom website for details about the capabilities and requirements of its scheduling application and services. The TSS-770-Z cannot be interfaced with a control system and cannot be custom programmed for any other functionality. An internet connection is required.
3. The TSS-770-Z may be powered by either a PoE or PoE+ power source when a light bar or hallway sign is connected. Refer to the Accessories section for a list of all available options. Refer to each accessory's spec sheet for further information.
4. Bluetooth technology is used solely for proximity detection and does not transmit or receive any control, multimedia, or personal data. Crestron Bluetooth beacons are only visible to Bluetooth enabled devices that are specifically programmed and configured to work with them.
5. The TSW-UMB-70 is also compatible with older TSW-UMB-PMK series preconstruction mounting kits and TSW-BBI series back boxes, allowing the TSS-770-Z to be installed in place of a previous generation touch screen.

TSS-1070 Features

Crestron® TSS-1070 series touch screens are designed to enhance and simplify room scheduling across an enterprise. The TSS-1070 installs near a meeting room or huddle space to provide a clear indication of its availability and scheduling while integrating seamlessly with a variety of popular scheduling services.

The TSS-1070 is also sold as part of a kit that includes one [TSW-1070-LB](#) series room availability light bar, providing a complete room scheduling solution out of the box.

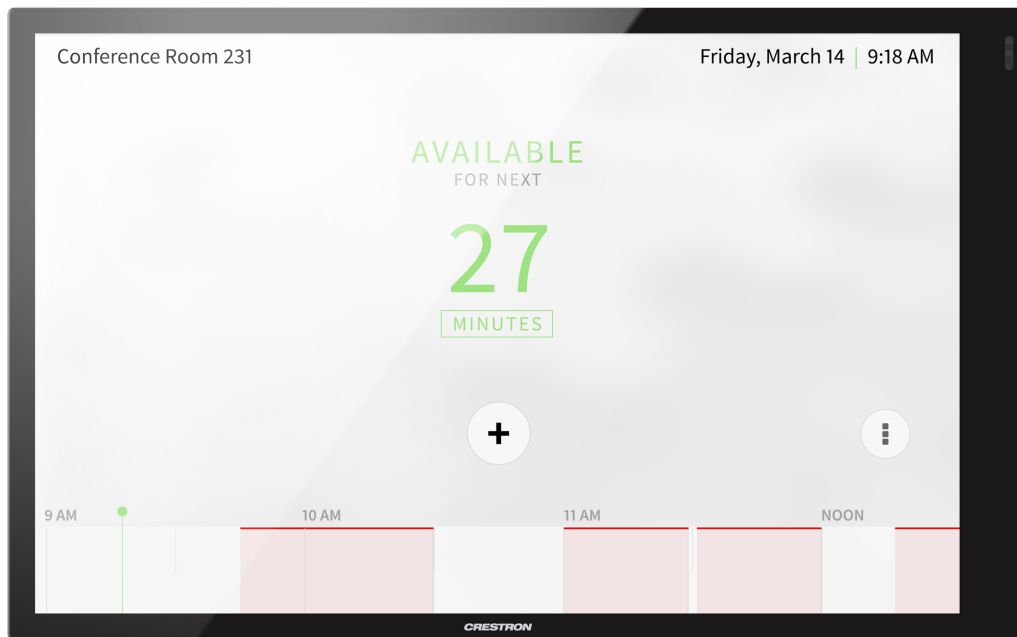

Key features include:

- Touch screen designed specifically for enterprise room scheduling applications
- Delivers a superior and cost-effective alternative to consumer tablet devices
- Integrates directly with various room scheduling services
- 10.1 in. (257 mm) widescreen capacitive touch screen display
- Standard U.S., U.K., and European electrical box installation with additional mounting options available
- Single wire Ethernet connection with PoE or PoE+ power
- Wi-Fi® network connectivity
- Dual USB 2.0 ports for room availability accessories
- Enterprise grade security and authentication
- Choice of white or black smooth finish

Crestron Room Scheduling App

The native Crestron Scheduling app helps to maximize productivity and manage usage for meeting spaces. If desired, the room can be reserved on the spot for an ad hoc meeting. A [CEN-ODT-C-POE](#) occupancy sensor (sold separately) can also be paired to the touch screen, allowing for occupancy status to be reported instantly to the scheduling app for no-shows and unscheduled room usage.¹

Crestron room scheduling also offers three levels of customization—ranging from simply configuring settings in the web user interface to modifying the application source code for a completely unique appearance—depending on the needs of an enterprise.

Running the Crestron Scheduling App, the TSS-1070 integrates directly with [Crestron Fusion](#)® software, Microsoft Exchange Server® software (for users of Outlook® software and Office 365® software), the Google Calendar™ calendaring app (including G Suite™ software), CollegeNET® 25Live® scheduling software, or Ad Astra® software. IBM® Notes® software is also supported through a Crestron Fusion on-premises server.

Third-Party Scheduling Apps

The TSS-1070 includes support various third-party scheduling applications. New providers are made available via firmware updates. Whatever provider you choose, setup is as simple as connecting the touch screen to the network and choosing an app from the web-based setup menu or built-in setup screens. The selected app downloads from the cloud and installs on the touch screen without any programming or control system required.^{1,2,3}

Built for Enterprise Scheduling

The TSS-1070 is engineered to meet the demands of a corporate office, conference center, or education environment. Its 10.1 in. (257 mm) capacitive display provides an intuitive user interface. The UI can be customized and branded with your choice of background images and logos.¹ A smaller 7 in. (178 mm) version ([TSS-770](#) series) is also available.

- **Functional:** The TSS-1070 provides a compact unit for scheduling applications that mounts over a standard electrical box or cutout. The TSS-1070 offers high-speed Ethernet and PoE/PoE+ connectivity, or, for deployments without access to Ethernet, can connect to the network over Wi-Fi® communications via a local wireless access point (WAP).
- **Versatile:** Crestron offers a variety of mounting options for mounting the TSS-1070 to drywall, masonry, glass, mullions, and other surfaces. Optional light bar and hallway sign accessories are available to increase the visibility of the room availability status.
- **Reliable:** The TSS-1070 is purpose-built for permanent installation and years of reliable 24/7 operation in a commercial environment. To ensure the latest features are available, the TSS-1070 checks nightly for app updates and loads the latest version automatically.
- **Secure:** The TSS-1070 employs enterprise-grade networking with robust security features such as 802.1X authentication, TLS encryption, HTTPS connectivity, and Active Directory® service integration. These features protect your network against service interruptions and malicious intrusions.
- **Manageable:** The TSS-1070 features cloud-based provisioning and management, which streamlines configuring, monitoring, and updating the touch screen on the network. The TSS-1070 also supports SNMP, so it can be monitored by your IT administrator.

Status Indicator Options

The TSS-1070 provides dual high-speed USB 2.0 ports for connecting Crestron room scheduling accessories (sold separately) to the touch screen that enhance an enterprise room scheduling solution.

NOTE: The touch screen supports the use of a single light bar or status indicator accessory only. The [RFID-USB](#) card reader accessory can be connected to the second USB port.

- The optional [TSW-1070-LB](#) series light bars provide a 180° visual indication of a room's availability status, illuminating green if the room is available and red when reserved, with options for custom color mixing and programming.⁴
- The optional [SSW-EL](#) and [SSC-EL](#) series hallway signs feature a two sided acrylic sign face that can be custom engraved with the room name or number. The [SIW-100](#) offers a lower profile wall mount status indicator.⁴

Bluetooth Beacon

The built-in Bluetooth® proximity detection beacon works with the Crestron Go App and Crestron App to determine when a mobile device is in or near the same room as the beacon, and signals the mobile app to automatically display the appropriate controls and information for the room.⁵

Proximity Sensor and Brightness Controls

The TSS-1070 provides a built-in proximity sensor that wakes the screen without requiring any user interaction, and automatic brightness controls ensure optimal visibility under varying lighting conditions.

Power over Ethernet

PoE (Power over Ethernet) eliminates the need for a local power supply or any dedicated power wiring. [Crestron PoE switches](#) (sold separately) offer a total networking solution with built-in PoE for multiple touch screens. A PoE Injector ([PWE-4803RU](#), sold separately) is also available to support a single touch screen.

NOTE: PoE+ is required when connecting a light bar or hallway sign via USB. Refer to the "Power" specifications for more details.

XiO Cloud Service

The TSS-1070 is compatible with the XiO Cloud® service, which remotely provisions, monitors, and manages Crestron devices across an enterprise or an entire client base. Built on the Microsoft® Azure® software platform and utilizing Microsoft's Azure IoT Hub technology, XiO Cloud enables installers and IT managers to deploy and manage thousands of devices simultaneously. Unlike other virtual machine-based cloud solutions, Azure services provide unlimited scalability. For more information, visit www.crestron.com/xiocloud.

Wall Mount Options

Using the bracket provided, the TSS-1070 is easily installed over a 2-gang or 3-gang US electrical box, or a 2-gang European or UK electrical box. A security latch option is included to deter unauthorized removal of the touch screen.

Additional wall mounting options are available using the optional [TSW-UMB-70](#) universal mounting bracket, [TSW-UMB-70-PMK](#) preconstruction mounting kit, and [TSW-UMB-70-BBI](#) back box (sold separately).⁶

Optional Mounting Accessories

The TSS-1070 supports numerous optional mounting accessories (sold separately) that allow the touch screen to be installed in all kinds of installations:

- The [TSW-1070-MSMK](#) multisurface mount kit allows a TSS-1070 touch screen to be mounted directly to virtually any flat surface, which is ideal for mounting at a meeting space entrance for room scheduling applications.
- The [TSW-770/1070-MUMK](#) allows the touch screen to be attached to the mullion of an interior glass wall, window, or partition.
- The [TSW-770/1070-RMB-1](#), [TSW-770/1070-RMB-2](#), and [TSW-1070-RMB-3](#) retrofit mounting brackets allow for retrofit installations in place of an older Crestron touch screen (APAD, CT-1000, LC-1000, TPS-4L, TPS-6L, or TPS-2000L) without having to tear out the old mounting hardware or patch the wall.
- Though not typical for most scheduling applications, the [TSW-1070-RMK-2](#) rack mount kit can be used to mount the touch screen into a 19 in. rack. When installed, the touch screen occupies four rack spaces.

The TSS-1070 is also compatible with Wall-Smart® flush wall mount products via a partnership with Crestron. For more information on supported Wall-Smart hardware, click [here](#).

Notes:

1. Actual functionality and on-screen appearance varies based on which scheduling app is in use and how the app is set up. The functionality described in this spec sheet generally refers to the Crestron Scheduling app. Each third-party provider determines the functionality and appearance of their respective app. Additionally, CollegeNET® 25Live® scheduling software and Ad Astra™ software do not support scheduling ad hoc meetings from the touch screen. Refer to each provider's website for more information.
2. Refer to the firmware release notes for a list of all scheduling apps that are supported by that firmware release.
3. Additional subscriptions and/or licenses may be required. Refer to each provider's website for details about the capabilities and requirements of its scheduling application and services. Third-party apps typically run on the TSS-1070 as they do on a tablet device. The TSS-1070 runs only one app, which is selected at setup. Only the apps approved and delivered by Crestron can run on the TSS-1070. The TSS-1070 cannot be interfaced with a control system and cannot be custom programmed for any other functionality. An internet connection is required.
4. The TSS-1070 must be powered by a PoE+ power source when a light bar or hallway sign is connected. Refer to the Accessories section for a list of all available options. Refer to each accessory's spec sheet for further information.
5. Bluetooth technology is used solely for proximity detection and does not transmit or receive any control, multimedia, or personal data. Crestron Bluetooth beacons are only visible to Bluetooth enabled devices that are specifically programmed and configured to work with them.
6. The TSW-UMB-70 is also compatible with older TSW-UMB-PMK series preconstruction mounting kits and TSW-BBI series back boxes, allowing the TSS-1070 to be installed in place of a previous generation touch screen.

TSS-1070-T Features

Crestron® TSS-1070-T series touch screens are designed to enhance and simplify room scheduling across an enterprise. The TSS-1070-T installs near a meeting room or huddle space to provide a clear indication of its availability and scheduling while integrating seamlessly with the Microsoft Teams® Panels scheduling application. Support for additional room scheduling services is also provided.

The TSS-1070-T is sold as part of a kit that includes one [TSW-1070-LB](#) series room availability light bar, providing a complete room scheduling solution out of the box.

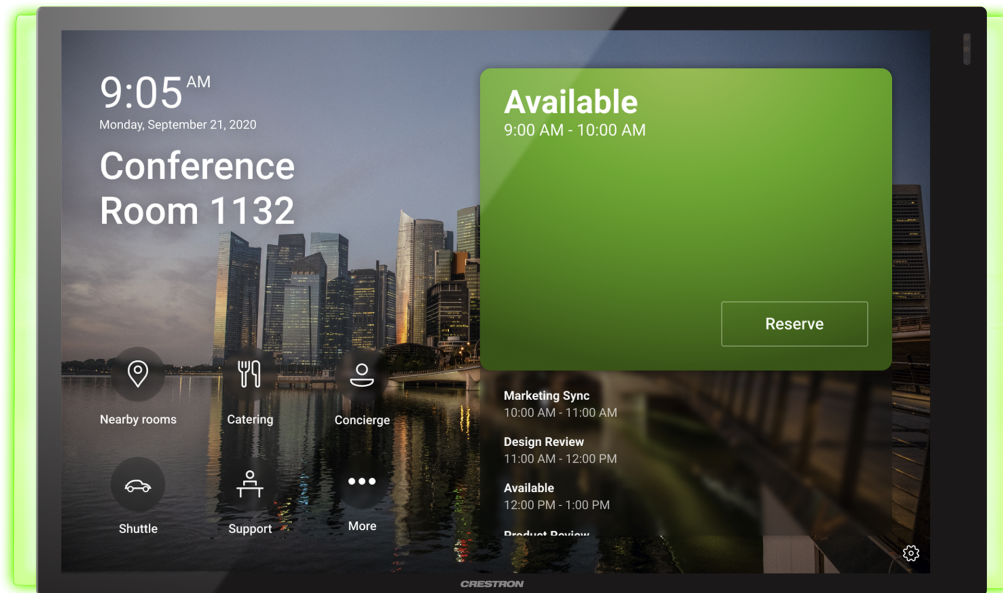

Key features include:

- Touch screen designed specifically to run the Microsoft Teams® Panels scheduling application
- Delivers a superior and cost-effective alternative to consumer tablet devices
- 10.1 in. (257 mm) widescreen capacitive touch screen display
- Standard U.S., U.K., and European electrical box installation with additional mounting options available
- Single wire Ethernet connection with PoE or PoE+ power
- Wi-Fi® network connectivity
- Dual USB 2.0 ports for room availability accessories
- Enterprise grade security and authentication
- Choice of white or black smooth finish

Microsoft Teams Panels

The native Microsoft Teams Panels scheduling application helps to maximize productivity and manage usage for meeting spaces via Microsoft Teams. The touch screen can be configured to use the Microsoft

Teams scheduling calendar, allowing users to book meetings through their Microsoft Teams account. If desired, the room can be reserved on the spot for an ad hoc meeting.^{1,2}

NOTE: For more information on Microsoft Teams Panels, refer to <https://docs.microsoft.com/en-us/microsoftteams/devices/teams-panels>.

Built for Enterprise Scheduling

The TSS-1070-T is engineered to meet the demands of a corporate office, conference center, or education environment. Its 10.1 in. (257 mm) capacitive display provides an intuitive user interface. A smaller 7 in. (178 mm) version ([TSS-770](#) series) is also available.

- **Functional:** The TSS-1070-T provides a compact unit for scheduling applications that mounts over a standard electrical box or cutout. The TSS-1070-T offers high-speed Ethernet and PoE/PoE+ connectivity, or, for deployments without access to Ethernet, can connect to the network over Wi-Fi® communications via a local wireless access point (WAP).
- **Versatile:** Crestron offers a variety of mounting options for mounting the TSS-1070-T to drywall, masonry, glass, mullions, and other surfaces. Optional light bar and hallway sign accessories are available to increase the visibility of the room availability status.
- **Reliable:** The TSS-1070-T is purpose-built for permanent installation and years of reliable 24/7 operation in a commercial environment. To ensure the latest features are available, the TSS-1070-T checks nightly for app updates and loads the latest version automatically.
- **Secure:** The TSS-1070-T employs enterprise-grade networking with robust security features such as 802.1X authentication, TLS encryption, HTTPS connectivity, and Active Directory® service integration. These features protect your network against service interruptions and malicious intrusions.
- **Manageable:** The TSS-1070-T features cloud-based provisioning and management, which streamlines configuring, monitoring, and updating the touch screen on the network. The TSS-1070-T also supports SNMP, so it can be monitored by your IT administrator.

Status Indicator Options

The TSS-1070-T provides dual high-speed USB 2.0 ports for connecting Crestron room scheduling accessories (sold separately) to the touch screen that enhance an enterprise room scheduling solution.

NOTE: The touch screen supports the use of a single light bar or status indicator accessory only. The [RFID-USB](#) card reader accessory can be connected to the second USB port.

- The included [TSW-1070-LB](#) series light bar provides a 180° visual indication of a room's availability status, illuminating green if the room is available and red when reserved, with options for custom color mixing and programming.³
- The optional [SSW-EL](#) and [SSC-EL](#) series hallway signs feature a two sided acrylic sign face that can be custom engraved with the room name or number. The [SIW-100](#) offers a lower profile wall mount status indicator.³

Bluetooth Beacon

The built-in Bluetooth® proximity detection beacon works with the Crestron Go App and Crestron App to determine when a mobile device is in or near the same room as the beacon, and signals the mobile app to automatically display the appropriate controls and information for the room.⁴

Proximity Sensor and Brightness Controls

The TSS-1070-T provides a built-in proximity sensor that wakes the screen without requiring any user interaction, and automatic brightness controls ensure optimal visibility under varying lighting conditions.

Power over Ethernet

PoE (Power over Ethernet) eliminates the need for a local power supply or any dedicated power wiring. [Crestron PoE switches](#) (sold separately) offer a total networking solution with built-in PoE for multiple touch screens. A PoE Injector ([PWE-4803RU](#), sold separately) is also available to support a single touch screen.

NOTE: PoE+ is required when connecting a light bar or hallway sign via USB. Refer to the "Power" specifications for more details.

XiO Cloud Service

The TSS-1070-T is compatible with the XiO Cloud® service, which remotely provisions, monitors, and manages Crestron devices across an enterprise or an entire client base. Built on the Microsoft® Azure® software platform and utilizing Microsoft's Azure IoT Hub technology, XiO Cloud enables installers and IT managers to deploy and manage thousands of devices simultaneously. Unlike other virtual machine-based cloud solutions, Azure services provide unlimited scalability. For more information, visit www.crestron.com/xiocloud.

Wall Mount Options

Using the bracket provided, the TSS-1070-T is easily installed over a 2-gang or 3-gang US electrical box, or a 2-gang European or UK electrical box. A security latch option is included to deter unauthorized removal of the touch screen.

Additional wall mounting options are available using the optional [TSW-UMB-70](#) universal mounting bracket, [TSW-UMB-70-PMK](#) preconstruction mounting kit, and [TSW-UMB-70-BBI](#) back box (sold separately).⁵

Optional Mounting Accessories

The TSS-1070-T supports numerous optional mounting accessories (sold separately) that allow the touch screen to be installed in all kinds of installations:

- The [TSW-1070-MSMK](#) multisurface mount kit allows a TSS-1070-T touch screen to be mounted directly to virtually any flat surface, which is ideal for mounting at a meeting space entrance for room scheduling applications.
- The [TSW-770/1070-MUMK](#) allows the touch screen to be attached to the mullion of an interior glass wall, window, or partition.

- The [TSW-770/1070-RMB-1](#), [TSW-770/1070-RMB-2](#), and [TSW-1070-RMB-3](#) retrofit mounting brackets allow for retrofit installations in place of an older Crestron touch screen (APAD, CT-1000, LC-1000, TPS-4L, TPS-6L, or TPS-2000L) without having to tear out the old mounting hardware or patch the wall.
- Though not typical for most scheduling applications, the [TSW-1070-RMK-2](#) rack mount kit can be used to mount the touch screen into a 19 in. rack. When installed, the touch screen occupies four rack spaces.

Notes:

1. Microsoft determines the functionality and appearance of the Microsoft Teams room scheduling application. Refer to the Microsoft website for more information.
2. Additional subscriptions and/or licenses may be required. Refer to the Microsoft website for details about the capabilities and requirements of its scheduling application and services. The TSS-1070-T cannot be interfaced with a control system and cannot be custom programmed for any other functionality. An internet connection is required.
3. The TSS-1070-T must be powered by a PoE+ power source when a light bar or hallway sign is connected. Refer to the Accessories section for a list of all available options. Refer to each accessory's spec sheet for further information.
4. Bluetooth technology is used solely for proximity detection and does not transmit or receive any control, multimedia, or personal data. Crestron Bluetooth beacons are only visible to Bluetooth enabled devices that are specifically programmed and configured to work with them.
5. The TSW-UMB-70 is also compatible with older TSW-UMB-PMK series preconstruction mounting kits and TSW-BBI series back boxes, allowing the TSS-1070-T to be installed in place of a previous generation touch screen.

TSS-1070-Z Features

Crestron® TSS-1070-Z series touch screens are designed to enhance and simplify room scheduling across an enterprise. The TSS-1070-Z installs near a meeting room or huddle space to provide a clear indication of its availability and scheduling while integrating seamlessly with the Zoom Rooms® scheduling application. Support for additional room scheduling services is also provided.

The TSS-1070-Z is sold as part of a kit that includes one [TSW-1070-LB](#) series room availability light bar, providing a complete room scheduling solution out of the box.



Key features include:

- Touch screen designed specifically to run the Zoom Rooms® scheduling application
- Delivers a superior and cost-effective alternative to consumer tablet devices
- 10.1 in. (257 mm) widescreen capacitive touch screen display
- Standard U.S., U.K., and European electrical box installation with additional mounting options available
- Single wire Ethernet connection with PoE or PoE+ power
- Wi-Fi® network connectivity
- Dual USB 2.0 ports for room availability accessories
- Enterprise grade security and authentication
- Choice of white or black smooth finish

Zoom Rooms Application

The native Zoom Rooms scheduling application helps to maximize productivity and manage usage for meeting spaces. The touch screen can be configured to use the Zoom Rooms scheduling calendar,

allowing users to check meeting room availability and book meetings through their organization's Zoom Rooms deployment. If desired, the room can be reserved on the spot for an ad hoc or future meeting^{1,2}

A provided USB drive boots the touch screen directly into Zoom Rooms scheduling mode for fast deployment.

NOTE: For more information on Zoom Rooms scheduling, refer to <https://support.zoom.us/hc/en-us/articles/115003336806-Using-Zoom-Rooms-scheduling-display>.

Built for Enterprise Scheduling

The TSS-1070-Z is engineered to meet the demands of a corporate office, conference center, or education environment. Its 10.1 in. (257 mm) capacitive display provides an intuitive user interface. A smaller 7 in. (178 mm) version ([TSS-770](#) series) is also available.

- **Functional:** The TSS-1070-Z provides a compact unit for scheduling applications that mounts over a standard electrical box or cutout. The TSS-1070-Z offers high-speed Ethernet and PoE/PoE+ connectivity, or, for deployments without access to Ethernet, can connect to the network over Wi-Fi® communications via a local wireless access point (WAP).
- **Versatile:** Crestron offers a variety of mounting options for mounting the TSS-1070-Z to drywall, masonry, glass, mullions, and other surfaces. Optional light bar and hallway sign accessories are available to increase the visibility of the room availability status.
- **Reliable:** The TSS-1070-Z is purpose-built for permanent installation and years of reliable 24/7 operation in a commercial environment. To ensure the latest features are available, the TSS-1070-Z checks nightly for app updates and loads the latest version automatically.
- **Secure:** The TSS-1070-Z employs enterprise-grade networking with robust security features such as 802.1X authentication, TLS encryption, HTTPS connectivity, and Active Directory® service integration. These features protect your network against service interruptions and malicious intrusions.
- **Manageable:** The TSS-1070-Z features cloud-based provisioning and management, which streamlines configuring, monitoring, and updating the touch screen on the network. The TSS-1070-Z also supports SNMP, so it can be monitored by your IT administrator.

Status Indicator Options

The TSS-1070-Z provides dual high-speed USB 2.0 ports for connecting Crestron room scheduling accessories (sold separately) to the touch screen that enhance an enterprise room scheduling solution.

NOTE: The touch screen supports the use of a single light bar or status indicator accessory only. The [RFID-USB](#) card reader accessory can be connected to the second USB port.

- The included [TSW-1070-LB](#) series light bar provides a 180° visual indication of a room's availability status, illuminating green if the room is available and red when reserved, with options for custom color mixing and programming.³
- The optional [SSW-EL](#) and [SSC-EL](#) series hallway signs feature a two sided acrylic sign face that can be custom engraved with the room name or number. The [SIW-100](#) offers a lower profile wall mount status indicator.³

Bluetooth Beacon

The built-in Bluetooth® proximity detection beacon works with the Crestron Go App and Crestron App to determine when a mobile device is in or near the same room as the beacon, and signals the mobile app to automatically display the appropriate controls and information for the room.

Proximity Sensor and Brightness Controls

The TSS-1070-Z provides a built-in proximity sensor that wakes the screen without requiring any user interaction, and automatic brightness controls ensure optimal visibility under varying lighting conditions.

Power over Ethernet

PoE (Power over Ethernet) eliminates the need for a local power supply or any dedicated power wiring. [Crestron PoE switches](#) (sold separately) offer a total networking solution with built-in PoE for multiple touch screens. A PoE Injector ([PWE-4803RU](#), sold separately) is also available to support a single touch screen.

NOTE: PoE+ is required when connecting a light bar or hallway sign via USB. Refer to the "Power" specifications for more details.

XiO Cloud Service

The TSS-1070-Z is compatible with the XiO Cloud® service, which remotely provisions, monitors, and manages Crestron devices across an enterprise or an entire client base. Built on the Microsoft® Azure® software platform and utilizing Microsoft's Azure IoT Hub technology, XiO Cloud enables installers and IT managers to deploy and manage thousands of devices simultaneously. Unlike other virtual machine-based cloud solutions, Azure services provide unlimited scalability. For more information, visit www.crestron.com/xiocloud.

Wall Mount Options

Using the bracket provided, the TSS-1070-Z is easily installed over a 2-gang or 3-gang US electrical box, or a 2-gang European or UK electrical box. A security latch option is included to deter unauthorized removal of the touch screen.

Additional wall mounting options are available using the optional [TSW-UMB-70](#) universal mounting bracket, [TSW-UMB-70-PMK](#) preconstruction mounting kit, and [TSW-UMB-70-BBI](#) back box (sold separately).⁵

Optional Mounting Accessories

The TSS-1070-Z supports numerous optional mounting accessories (sold separately) that allow the touch screen to be installed in all kinds of installations:

- The [TSW-1070-MSMK](#) multisurface mount kit allows a TSS-1070-Z touch screen to be mounted directly to virtually any flat surface, which is ideal for mounting at a meeting space entrance for room scheduling applications.
- The [TSW-770/1070-MUMK](#) allows the touch screen to be attached to the mullion of an interior glass wall, window, or partition.

- The [TSW-770/1070-RMB-1](#), [TSW-770/1070-RMB-2](#), and [TSW-1070-RMB-3](#) retrofit mounting brackets allow for retrofit installations in place of an older Crestron touch screen (APAD, CT-1000, LC-1000, TPS-4L, TPS-6L, or TPS-2000L) without having to tear out the old mounting hardware or patch the wall.
- Though not typical for most scheduling applications, the [TSW-1070-RMK-2](#) rack mount kit can be used to mount the touch screen into a 19 in. rack. When installed, the touch screen occupies four rack spaces.

Notes:

1. Zoom determines the functionality and appearance of the Zoom Rooms® room scheduling application. Refer to the Zoom® website for more information.
2. Additional subscriptions and/or licenses may be required. Refer to the Zoom website for details about the capabilities and requirements of its scheduling application and services. The TSS-1070-Z cannot be interfaced with a control system and cannot be custom programmed for any other functionality. An internet connection is required.
3. The TSS-1070-Z must be powered by a PoE+ power source when a light bar or hallway sign is connected. Refer to the Accessories section for a list of all available options. Refer to each accessory's spec sheet for further information.
4. Bluetooth technology is used solely for proximity detection and does not transmit or receive any control, multimedia, or personal data. Crestron Bluetooth beacons are only visible to Bluetooth enabled devices that are specifically programmed and configured to work with them.
5. The TSW-UMB-70 is also compatible with older TSW-UMB-PMK series preconstruction mounting kits and TSW-BBI series back boxes, allowing the TSS-1070-Z to be installed in place of a previous generation touch screen.

Physical Description

The TSS-70 Series provides the following connectors and indicators.

TSS-770 and TSS-1070 Series Connectors

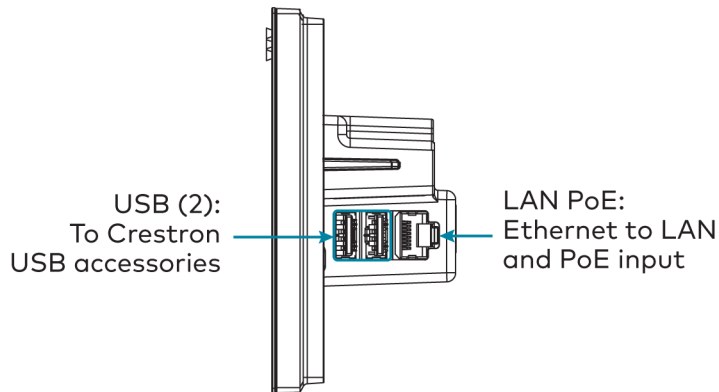

Connectors and Indicators

LAN PoE	(1) 8-pin RJ-45 connector, female, with 2 LED indicators; 100BASE-TX Ethernet port; PoE+ PD port; Green and yellow LEDs indicate Ethernet port status
USB	(2) USB Type-A connectors, female; USB 2.0 host ports

NOTE: The touch screen supports the use of a single light bar or status indicator accessory only. The [RFID-USB](#) card reader accessory can be connected to the second USB port.

Specifications

Refer to the following sections for more information on the specifications for various TSS-70 Series models.

- [TSS-770 Specifications on page 29](#)
- [TSS-770-T Specifications on page 34](#)
- [TSS-770-Z Specifications on page 39](#)
- [TSS-1070 Specifications on page 44](#)
- [TSS-1070-T Specifications on page 49](#)
- [TSS-1070-Z Specifications on page 53](#)

TSS-770 Specifications

Product specifications for the TSS-770 are provided below.

Product Specifications

Room Scheduling Support

Crestron Scheduling App Crestron Fusion® software, Microsoft Exchange Server® and Office 365® software, Google Calendar™ calendaring app and G Suite™ software, CollegeNET® 25Live® software, and Ad Astra™ software (IBM® Notes® software is also supported through Crestron Fusion on-premises server only)

Third-Party Apps Includes support for various third-party scheduling apps^{1,2,3}

Languages

Crestron Fusion® Software Chinese (Simplified), Chinese (Traditional), Danish, Dutch (Netherlands), English (US), English (UK), French, German, Hebrew, Italian, Japanese, Korean, Norwegian, Portuguese (Brazil), Portuguese (Portugal), Russian, Spanish, Swedish

Wired Communications

Ethernet 100 Mbps, auto switching, auto negotiating, auto discovery, full/half duplex, TCP/IP, UDP/IP, DHCP, SSL, TLS, SSH, SFTP (SSH File Transfer Protocol), IEEE 802.1X, SNMP, HTTPS, IPv4 or IPv6, Active Directory® service authentication, HTTPS web browser setup, XiO Cloud® client, IEEE 802.3at compliant

USB USB 2.0 host for light bar or hallway sign⁴

Wireless Communications

Transceiver IEEE 802.11a/b/g/n/ac Wi-Fi (2.4 or 5 GHz 2-way RF), static IP or dynamic IP via DHCP

Security 64 and 128-bit WEP, WPA and WPA2-PSK with TKIP and AES

Range Up to 50 ft (15 m), subject to site-specific conditions

Bluetooth® Hardware Crestron Bluetooth beacon⁵

Touch Screen Display

Display Type TFT active matrix color LCD

Size 7 in. (178 mm) diagonal

Aspect Ratio 16:10 WXGA

Resolution 1280 x 800 pixels

Brightness 350 nits (cd/m²)

Contrast 850:1

Color Depth 24 bit, 16.7M colors

Illumination Edgelit LED with auto brightness control

Viewing Angle	±80° horizontal, ±80° vertical
Touch Screen	Projected capacitive, 5-point multitouch capable

Buttons

Virtual Buttons	(6) Virtual buttons in collapsible universal tool bar, per-button show/hide, preconfigured with icons for Power, Home, Lights, Up, Down, and Microphone
Reset	Pin hole on rear panel for hardware reset

Audio

Features	Built-in speakers for touch feedback and alerts
----------	---

Connectors

LAN PoE	(1) 8-pin RJ-45 connector, female, with 2 LED indicators; 100BASE-TX Ethernet port; PoE+ PD port; Green and yellow LEDs indicate Ethernet port status
USB	(2) USB Type-A connectors, female; USB 2.0 host ports; For optional room scheduling accessories

NOTE: The touch screen supports the use of a single light bar or status indicator accessory only. The [RFID-USB](#) card reader accessory can be connected to the second USB port.

Power

PoE (Power over Ethernet)	IEEE 802.3at Type 2 compliant PoE+ PD (Powered Device); Requests 15 W from an 802.3at Type 2 PSE with LLDP advanced power management; Requests 30 W (PoE+ Class 4) from an 802.3at Type 2 PSE without LLDP; Requests 15.4 W (PoE Class 0) from an 802.3af (or 802.3at Type 1) PSE
---------------------------	--

Environmental

Temperature	32 to 104°F (0 to 40°C)
Humidity	10% to 95% RH (noncondensing)
Heat Dissipation	44 BTU/hr

Construction

Housing	Plastic, smooth black or white finish, edge-to-edge glass with black or white surround
Mounting	Surface mount over a 2 or 3-gang US electrical box, 2-gang European (DIN 49073) electrical box, or 2-gang UK (BS 4662) electrical box; Lectern mount over a 2 in. H x 3-3/4 in. W (51 mm H x 96 mm W) cutout; 1-3/8 in. (35 mm) minimum mounting depth; Wall mount, surface mount, and rack options available separately

Dimensions

Height	4.17 in. (106 mm)
Width	6.80 in. (173 mm)
Depth	1.99 in. (51 mm)

Dimensions do not include the mounting bracket or add-on accessories

Weight

14.11 oz (400 g)

Compliance

Regulatory Model: M201923002
IC, CE, FCC Part 15 Class B digital device

Dimension Drawings

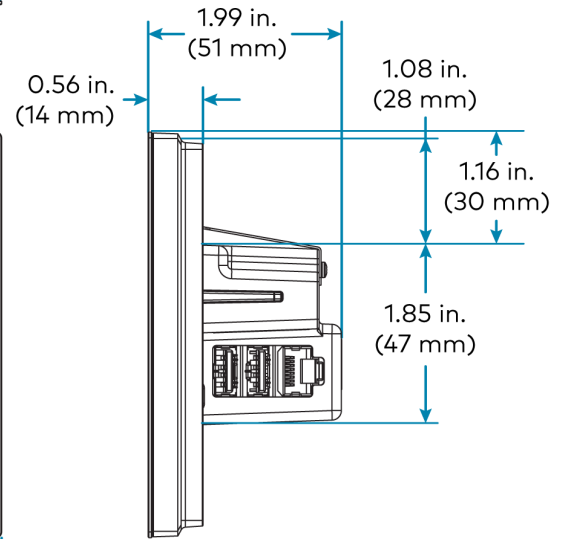
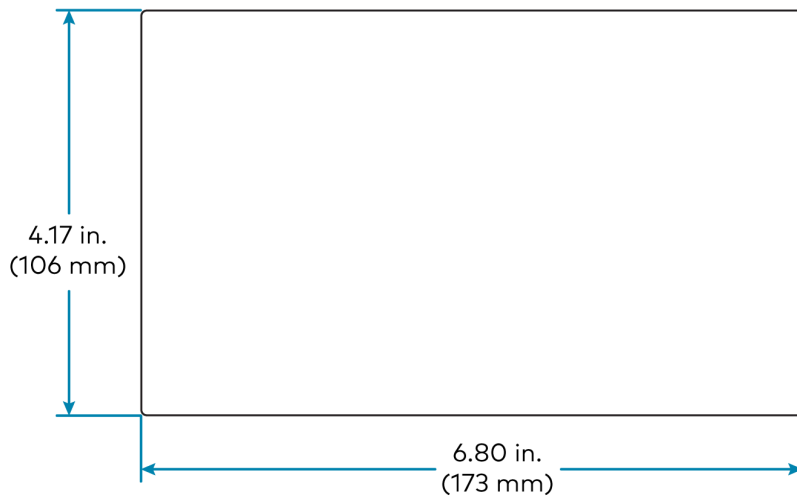
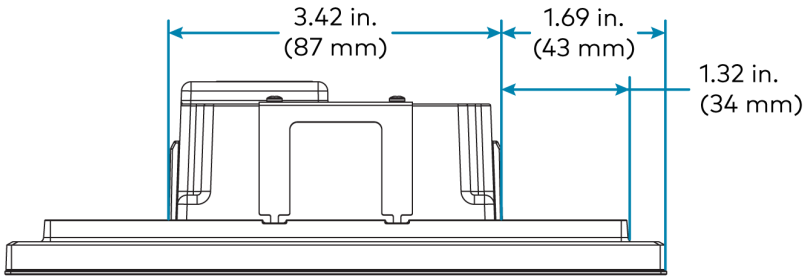
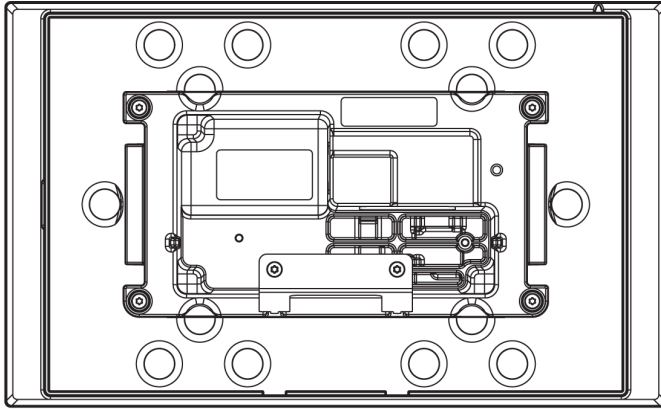

Notes:

1. Actual functionality and on-screen appearance varies based on which scheduling app is in use and how the app is set up. The functionality described in this spec sheet generally refers to the Crestron Scheduling app. Each third-party provider determines the functionality and appearance of their respective app. Additionally, CollegeNET® 25Live® scheduling software and Ad Astra™ software do not support scheduling ad hoc meetings from the touch screen. Refer to each provider's website for more information.
2. Refer to the firmware release notes for a list of all scheduling apps that are supported by that firmware release.
3. Additional subscriptions and/or licenses may be required. Refer to each provider's website for details about the capabilities and requirements of its scheduling application and services. Third-party apps typically run on the TSS-770 as they do on a tablet device. The TSS-770 runs only one app, which is selected at setup. Only the apps approved and delivered by Crestron can run on the TSS-770. The TSS-770 cannot be interfaced with a control system and cannot be custom programmed for any other functionality. An internet connection is required.
4. The TSS-770 may be powered by either a PoE or PoE+ power source when a light bar or hallway sign is connected. Refer to the Accessories section for a list of all available options. Refer to each accessory's spec sheet for further information.
5. Bluetooth technology is used solely for proximity detection and does not transmit or receive any control, multimedia, or personal data. Crestron Bluetooth beacons are only visible to Bluetooth enabled devices that are specifically programmed and configured to work with them.
6. The TSW-UMB-70 is also compatible with older TSW-UMB-PMK series preconstruction mounting kits and TSW-BBI series back boxes, allowing the TSS-770 to be installed in place of a previous generation touch screen.

TSS-770-T Specifications

Product specifications for the TSS-770-T are provided below.

Product Specifications

Room Scheduling Support

Microsoft Teams® Panels	Includes native support for Microsoft Teams Panels scheduling application ^{1,2}
Additional Apps	Includes support for Crestron and various third-party scheduling apps

Languages

Crestron Fusion® Software	Chinese (Simplified), Chinese (Traditional), Danish, Dutch (Netherlands), English (US), English (UK), French, German, Hebrew, Italian, Japanese, Korean, Norwegian, Portuguese (Brazil), Portuguese (Portugal), Russian, Spanish, Swedish
----------------------------------	---

Wired Communications

Ethernet	100 Mbps, auto switching, auto negotiating, auto discovery, full/half duplex, TCP/IP, UDP/IP, DHCP, SSL, TLS, SSH, SFTP (SSH File Transfer Protocol), IEEE 802.1X, SNMP, HTTPS, IPv4 or IPv6, Active Directory® service authentication, HTTPS web browser setup, XiO Cloud® client, IEEE 802.3at compliant
USB	USB 2.0 host for light bar or hallway sign ³

Wireless Communications

Transceiver	IEEE 802.11a/b/g/n/ac Wi-Fi (2.4 or 5 GHz 2-way RF), static IP or dynamic IP via DHCP
Security	64 and 128-bit WEP, WPA and WPA2-PSK with TKIP and AES
Range	Up to 50 ft (15 m), subject to site-specific conditions
Bluetooth® Hardware	Crestron Bluetooth beacon ⁴

Touch Screen Display

Display Type	TFT active matrix color LCD
Size	7 in. (178 mm) diagonal
Aspect Ratio	16:10 WXGA
Resolution	1280 x 800 pixels
Brightness	350 nits (cd/m ²)
Contrast	850:1
Color Depth	24 bit, 16.7M colors
Illumination	Edgelit LED with auto brightness control
Viewing Angle	±80° horizontal, ±80° vertical
Touch Screen	Projected capacitive, 5-point multitouch capable

Buttons

Virtual Buttons	(6) Virtual buttons in collapsible universal tool bar, per-button show/hide, preconfigured with icons for Power, Home, Lights, Up, Down, and Microphone
Reset	Pin hole on rear panel for hardware reset

Audio

Features	Built-in speakers for touch feedback and alerts
-----------------	---

Connectors

LAN PoE	(1) 8-pin RJ-45 connector, female, with 2 LED indicators; 100BASE-TX Ethernet port; PoE+ PD port; Green and yellow LEDs indicate Ethernet port status
USB	(2) USB Type-A connectors, female; USB 2.0 host ports; For optional room scheduling accessories

NOTE: The touch screen supports the use of a single light bar or status indicator accessory only. The [RFID-USB](#) card reader accessory can be connected to the second USB port.

Power

PoE (Power over Ethernet)	IEEE 802.3at Type 2 compliant PoE+ PD (Powered Device); Requests 15 W from an 802.3at Type 2 PSE with LLDP advanced power management; Requests 30 W (PoE+ Class 4) from an 802.3at Type 2 PSE without LLDP; Requests 15.4 W (PoE Class 0) from an 802.3af (or 802.3at Type 1) PSE
----------------------------------	--

Environmental

Temperature	41 to 104°F (5 to 40°C)
Humidity	10% to 90% RH (noncondensing)
Heat Dissipation	49 BTU/hr

Construction

Housing	Plastic, smooth black or white finish, edge-to-edge glass with black or white surround
Mounting	Surface mount over a 2 or 3-gang US electrical box, 2-gang European (DIN 49073) electrical box, or 2-gang UK (BS 4662) electrical box; Lectern mount over a 2 in. H x 3-3/4 in. W (51 mm H x 96 mm W) cutout; 1-3/8 in. (35 mm) minimum mounting depth; Wall mount, surface mount, and rack options available separately

Dimensions

Height	4.17 in. (106 mm)
Width	7.30 in. (185 mm)
Depth	2.26 in. (57 mm)

Weight

14.11 oz (400 g)

Compliance

Regulatory Model: M201923002

IC, CE, FCC Part 15 Class B digital device

Dimension Drawings

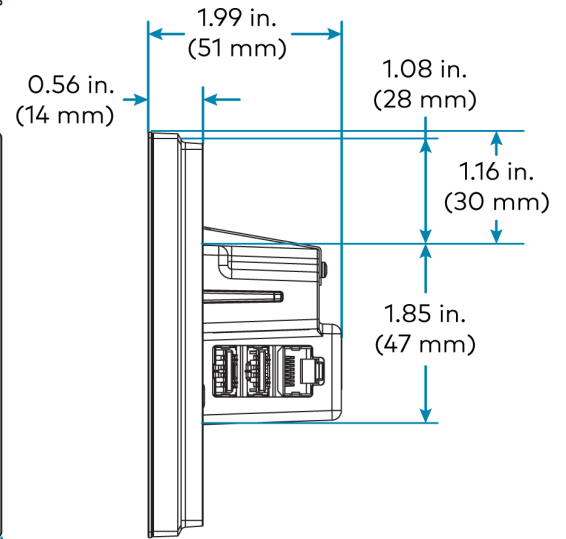
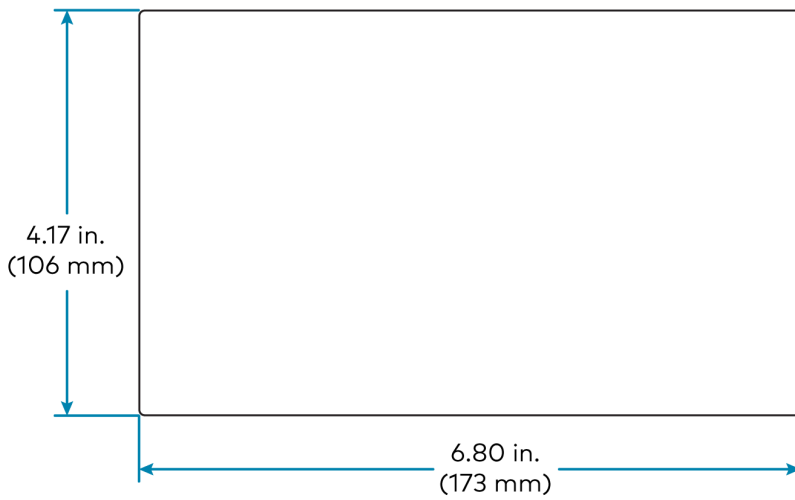
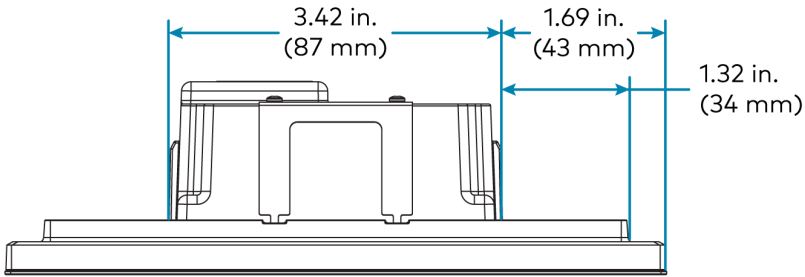
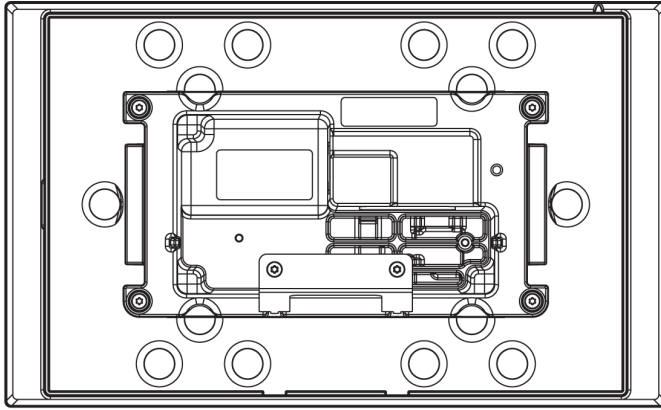

Notes:

1. Microsoft determines the functionality and appearance of the Microsoft Teams room scheduling application. Refer to the Microsoft website for more information.
2. Additional subscriptions and/or licenses may be required. Refer to the Microsoft website for details about the capabilities and requirements of its scheduling application and services. The TSS-770-T cannot be interfaced with a control system and cannot be custom programmed for any other functionality. An internet connection is required.
3. The TSS-770-T may be powered by either a PoE or PoE+ power source when a light bar or hallway sign is connected. Refer to the Accessories section for a list of all available options. Refer to each accessory's spec sheet for further information.
4. Bluetooth technology is used solely for proximity detection and does not transmit or receive any control, multimedia, or personal data. Crestron Bluetooth beacons are only visible to Bluetooth enabled devices that are specifically programmed and configured to work with them.
5. The TSW-UMB-70 is also compatible with older TSW-UMB-PMK series preconstruction mounting kits and TSW-BBI series back boxes, allowing the TSS-770-T to be installed in place of a previous generation touch screen.

TSS-770-Z Specifications

Product specifications for the TSS-770-Z are provided below.

Product Specifications

Room Scheduling Support

Zoom Rooms® App	Includes native support for Zoom Rooms scheduling application ^{1,2}
Additional Apps	Includes support for Crestron and various third-party scheduling apps

Languages

Crestron Fusion® Software	Chinese (Simplified), Chinese (Traditional), Danish, Dutch (Netherlands), English (US), English (UK), French, German, Hebrew, Italian, Japanese, Korean, Norwegian, Portuguese (Brazil), Portuguese (Portugal), Russian, Spanish, Swedish
----------------------------------	---

NOTE: Only a subset of these languages are available while running the Zoom Rooms application.

Wired Communications

Ethernet	100 Mbps, auto switching, auto negotiating, auto discovery, full/half duplex, TCP/IP, UDP/IP, DHCP, SSL, TLS, SSH, SFTP (SSH File Transfer Protocol), IEEE 802.1X, SNMP, HTTPS, IPv4 or IPv6, Active Directory® service authentication, HTTPS web browser setup, XiO Cloud® client, IEEE 802.3at compliant
USB	USB 2.0 host for light bar or hallway sign ³

Wireless Communications

Transceiver	IEEE 802.11a/b/g/n/ac Wi-Fi (2.4 or 5 GHz 2-way RF), static IP or dynamic IP via DHCP
Security	64 and 128-bit WEP, WPA and WPA2-PSK with TKIP and AES
Range	Up to 50 ft (15 m), subject to site-specific conditions
Bluetooth® Hardware	Crestron Bluetooth beacon ⁴

Touch Screen Display

Display Type	TFT active matrix color LCD
Size	7 in. (178 mm) diagonal
Aspect Ratio	16:10 WXGA
Resolution	1280 x 800 pixels
Brightness	350 nits (cd/m ²)
Contrast	850:1
Color Depth	24 bit, 16.7M colors
Illumination	Edgelit LED with auto brightness control
Viewing Angle	±80° horizontal, ±80° vertical

Touch Screen Projected capacitive, 5-point multitouch capable

Buttons

Virtual Buttons (6) Virtual buttons in collapsible universal tool bar, per-button show/hide, preconfigured with icons for Power, Home, Lights, Up, Down, and Microphone

Reset Pin hole on rear panel for hardware reset

Audio

Features Built-in speakers for touch feedback and alerts

Connectors

LAN PoE (1) 8-pin RJ-45 connector, female, with 2 LED indicators;
100BASE-TX Ethernet port;
PoE+ PD port;
Green and yellow LEDs indicate Ethernet port status

USB (2) USB Type-A connectors, female;
USB 2.0 host ports;
For optional room scheduling accessories

NOTE: The touch screen supports the use of a single light bar or status indicator accessory only. The [RFID-USB](#) card reader accessory can be connected to the second USB port.

Power

PoE (Power over Ethernet) IEEE 802.3at Type 2 compliant PoE+ PD (Powered Device);
Requests 15 W from an 802.3at Type 2 PSE with LLDP advanced power management;
Requests 30 W (PoE+ Class 4) from an 802.3at Type 2 PSE without LLDP;
Requests 15.4 W (PoE Class 0) from an 802.3af (or 802.3at Type 1) PSE

Environmental

Temperature 41 to 104°F (5 to 40°C)

Humidity 10% to 90% RH (noncondensing)

Heat Dissipation 49 BTU/hr

Construction

Housing	Plastic, smooth black or white finish, edge-to-edge glass with black or white surround
Mounting	Surface mount over a 2 or 3-gang US electrical box, 2-gang European (DIN 49073) electrical box, or 2-gang UK (BS 4662) electrical box; Lectern mount over a 2 in. H x 3-3/4 in. W (51 mm H x 96 mm W) cutout; 1-3/8 in. (35 mm) minimum mounting depth; Wall mount, surface mount, and rack options available separately

Dimensions

Height	4.17 in. (106 mm)
Width	7.30 in. (185 mm)
Depth	2.26 in. (57 mm)

Weight

14.11 oz (400 g)

Compliance

Regulatory Model: M201923002

IC, CE, FCC Part 15 Class B digital device

Dimension Drawings

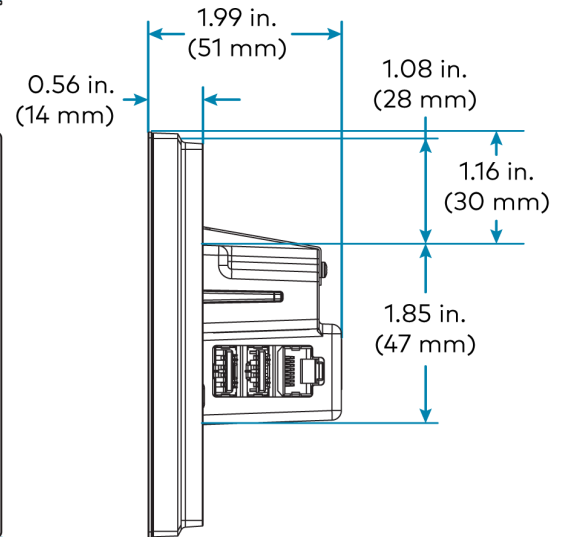
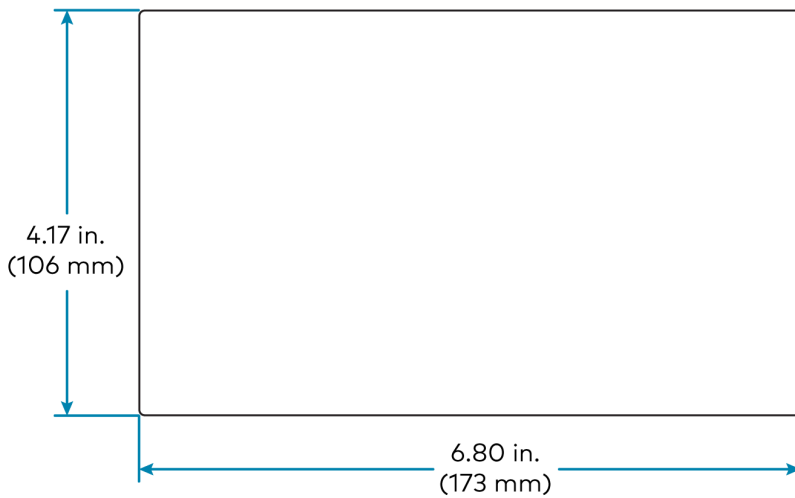
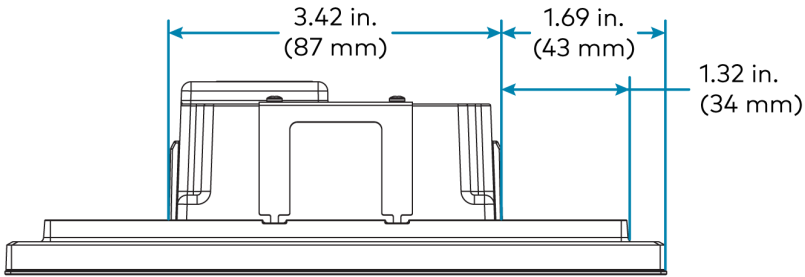
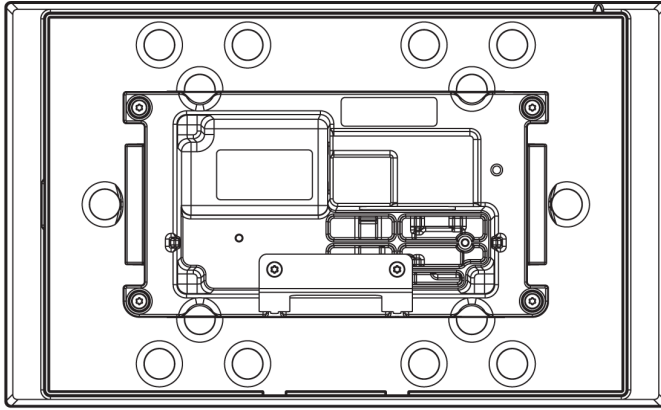

Notes:

1. Zoom determines the functionality and appearance of the Zoom Rooms® room scheduling application. Refer to the Zoom® website for more information.
2. Additional subscriptions and/or licenses may be required. Refer to the Zoom website for details about the capabilities and requirements of its scheduling application and services. The TSS-770-Z cannot be interfaced with a control system and cannot be custom programmed for any other functionality. An internet connection is required.
3. The TSS-770-Z may be powered by either a PoE or PoE+ power source when a light bar or hallway sign is connected. Refer to the Accessories section for a list of all available options. Refer to each accessory's spec sheet for further information.
4. Bluetooth technology is used solely for proximity detection and does not transmit or receive any control, multimedia, or personal data. Crestron Bluetooth beacons are only visible to Bluetooth enabled devices that are specifically programmed and configured to work with them.
5. The TSW-UMB-70 is also compatible with older TSW-UMB-PMK series preconstruction mounting kits and TSW-BBI series back boxes, allowing the TSS-770-Z to be installed in place of a previous generation touch screen.

TSS-1070 Specifications

Product specifications for the TSS-1070 are provided below.

Product Specifications

Room Scheduling Support

Crestron Scheduling App Crestron Fusion® software, Microsoft Exchange Server® and Office 365® software, Google Calendar™ calendaring app and G Suite™ software, CollegeNET® 25Live® software, and Ad Astra™ software (IBM® Notes® software is also supported through Crestron Fusion on-premises server only)

Third-Party Apps Includes support for various third-party scheduling apps^{1,2,3}

Languages

Crestron Fusion® Software Chinese (Simplified), Chinese (Traditional), Danish, Dutch (Netherlands), English (US), English (UK), French, German, Hebrew, Italian, Japanese, Korean, Norwegian, Portuguese (Brazil), Portuguese (Portugal), Russian, Spanish, Swedish

Wired Communications

Ethernet 100 Mbps, auto switching, auto negotiating, auto discovery, full/half duplex, TCP/IP, UDP/IP, DHCP, SSL, TLS, SSH, SFTP (SSH File Transfer Protocol), IEEE 802.1X, SNMP, HTTPS, IPv4 or IPv6, Active Directory® service authentication, HTTPS web browser setup, XiO Cloud® client, IEEE 802.3at compliant

USB USB 2.0 host for light bar or hallway sign⁴

Wireless Communications

Transceiver IEEE 802.11a/b/g/n/ac Wi-Fi (2.4 or 5 GHz 2-way RF), static IP or dynamic IP via DHCP

Security 64 and 128-bit WEP, WPA and WPA2-PSK with TKIP and AES

Range Up to 50 ft (15 m), subject to site-specific conditions

Bluetooth® Hardware Crestron Bluetooth beacon⁵

Touch Screen Display

Display Type TFT active matrix color LCD

Size 10.1 in. (257 mm) diagonal

Aspect Ratio 16:10 WUXGA

Resolution 1920 x 1200 pixels

Brightness 400 nits (cd/m²)

Contrast 1000:1

Color Depth 24 bit, 16.7M colors

Illumination Edgelit LED with auto brightness control

Viewing Angle ±80° horizontal, ±80° vertical

Touch Screen Projected capacitive, 5-point multitouch capable

Buttons

Virtual Buttons (6) Virtual buttons in collapsible universal tool bar, per-button show/hide, preconfigured with icons for Power, Home, Lights, Up, Down, and Microphone

Reset Pin hole on rear panel for hardware reset

Audio

Features Built-in speakers for touch feedback and alerts

Connectors

LAN PoE (1) 8-pin RJ-45 connector, female, with 2 LED indicators;
100BASE-TX Ethernet port;
PoE+ PD port;
Green and yellow LEDs indicate Ethernet port status

USB (2) USB Type-A connectors, female;
USB 2.0 host ports;
For optional room scheduling accessories

NOTE: The touch screen supports the use of a single light bar or status indicator accessory only. The [RFID-USB](#) card reader accessory can be connected to the second USB port.

Power

PoE (Power over Ethernet) IEEE 802.3at Type 2 compliant PoE+ PD (Powered Device);
Normally requests 15 W from an 802.3at Type 2 PSE with LLDP advanced power management;
With room scheduling and USB enabled, requests 18 W from an 802.3at Type 2 PSE with LLDP;
Requests 30 W (PoE+ Class 4) from an 802.3at Type 2 PSE without LLDP;
Requests 15.4 W (PoE Class 0) from an 802.3af (or 802.3at Type 1) PSE

NOTE: Enabling the USB port requires use of an 802.3at Type 2 PoE+ PSE.

Environmental

Temperature	32 to 104°F (0 to 40°C)
Humidity	10% to 95% RH (noncondensing)
Heat Dissipation	44 BTU/hr

Construction

Housing	Plastic, smooth black or white finish, edge-to-edge glass with black or white surround
Mounting	Surface mount over a 2 or 3-gang US electrical box, 2-gang European (DIN 49073) electrical box, or 2-gang UK (BS 4662) electrical box; Lectern mount over a 2 in. H x 3-3/4 in. W (51 mm H x 96 mm W) cutout; 1-3/8 in. (35 mm) minimum mounting depth; Wall mount, surface mount, and rack options available separately

Dimensions

Height	5.87 in. (149 mm)
Width	9.46 in. (240 mm)
Depth	2.01 in. (51 mm)

Dimensions do not include the mounting bracket or add-on accessories

Weight

1.61 lb (730 g)

Compliance

Regulatory Model: M201923003
IC, CE, FCC Part 15 Class B digital device

Dimension Drawings

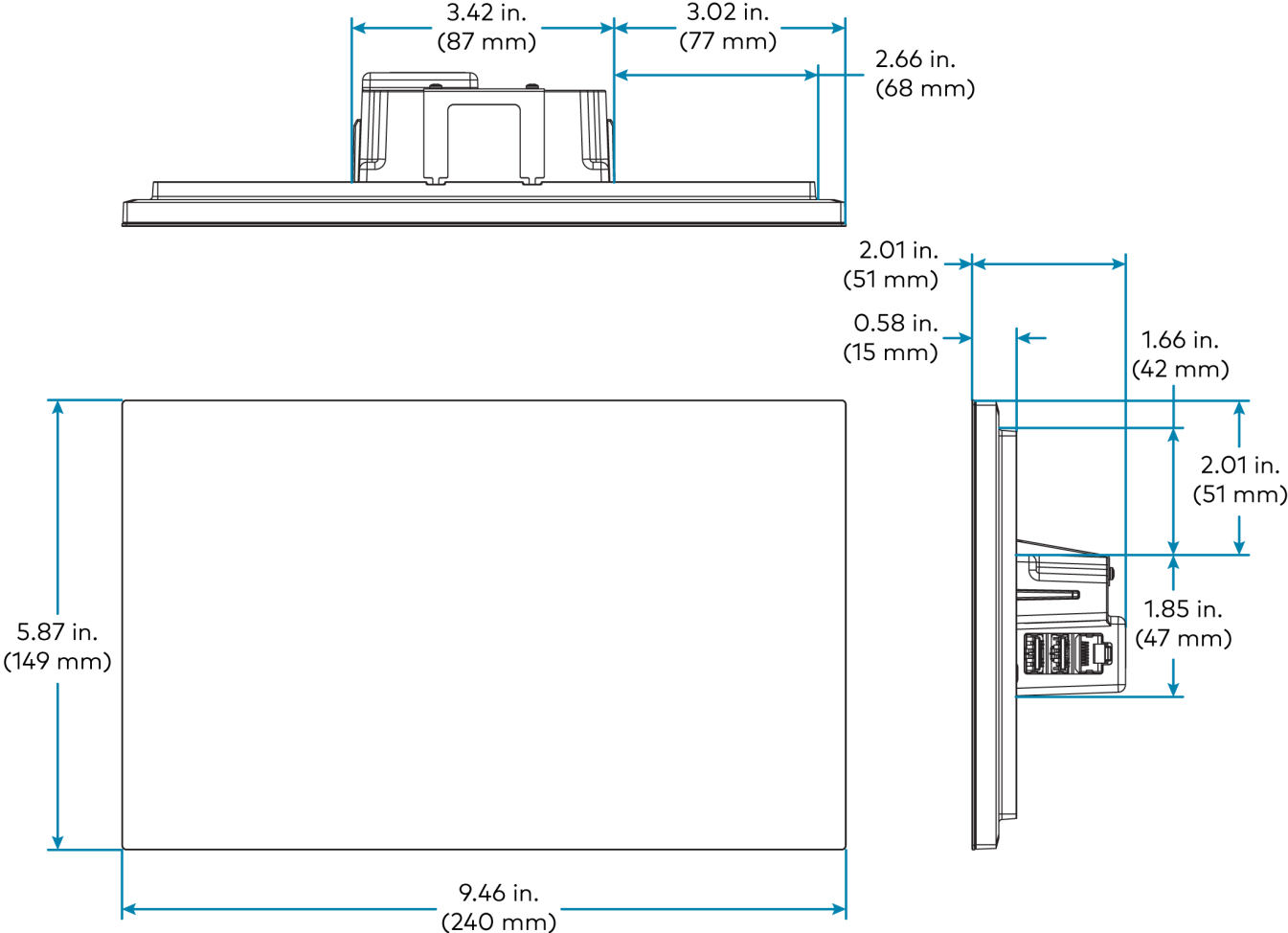

Notes:

1. Actual functionality and on-screen appearance varies based on which scheduling app is in use and how the app is set up. The functionality described in this spec sheet generally refers to the Crestron Scheduling app. Each third-party provider determines the functionality and appearance of their respective app. Additionally, CollegeNET® 25Live® scheduling software and Ad Astra™ software do not support scheduling ad hoc meetings from the touch screen. Refer to each provider's website for more information.
2. Refer to the firmware release notes for a list of all scheduling apps that are supported by that firmware release.
3. Additional subscriptions and/or licenses may be required. Refer to each provider's website for details about the capabilities and requirements of its scheduling application and services. Third-party apps typically run on the TSS-1070 as they do on a tablet device. The TSS-1070 runs only one app, which is selected at setup. Only the apps approved and delivered by Crestron can run on the TSS-1070. The TSS-1070 cannot be interfaced with a control system and cannot be custom programmed for any other functionality. An internet connection is required.
4. The TSS-1070 must be powered by a PoE+ power source when a light bar or hallway sign is connected. Refer to the Accessories section for a list of all available options. Refer to each accessory's spec sheet for further information.
5. Bluetooth technology is used solely for proximity detection and does not transmit or receive any control, multimedia, or personal data. Crestron Bluetooth beacons are only visible to Bluetooth enabled devices that are specifically programmed and configured to work with them.
6. The TSW-UMB-70 is also compatible with older TSW-UMB-PMK series preconstruction mounting kits and TSW-BBI series back boxes, allowing the TSS-1070 to be installed in place of a previous generation touch screen.

TSS-1070-T Specifications

Product specifications for the TSS-1070-T are provided below.

Product Specifications

Room Scheduling Support

Microsoft Teams® Panels	Includes native support for Microsoft Teams Panels scheduling application ^{1,2}
Additional Apps	Includes support for Crestron and various third-party scheduling apps

Languages

Crestron Fusion® Software	Chinese (Simplified), Chinese (Traditional), Danish, Dutch (Netherlands), English (US), English (UK), French, German, Hebrew, Italian, Japanese, Korean, Norwegian, Portuguese (Brazil), Portuguese (Portugal), Russian, Spanish, Swedish
----------------------------------	---

Wired Communications

Ethernet	100 Mbps, auto switching, auto negotiating, auto discovery, full/half duplex, TCP/IP, UDP/IP, DHCP, SSL, TLS, SSH, SFTP (SSH File Transfer Protocol), IEEE 802.1X, SNMP, HTTPS, IPv4 or IPv6, Active Directory® service authentication, HTTPS web browser setup, XiO Cloud® client, IEEE 802.3at compliant
USB	USB 2.0 host for light bar or hallway sign ³

Wireless Communications

Transceiver	IEEE 802.11a/b/g/n/ac Wi-Fi (2.4 or 5 GHz 2-way RF), static IP or dynamic IP via DHCP
Security	64 and 128-bit WEP, WPA and WPA2-PSK with TKIP and AES
Range	Up to 50 ft (15 m), subject to site-specific conditions
Bluetooth® Hardware	Crestron Bluetooth beacon ⁴

Touch Screen Display

Display Type	TFT active matrix color LCD
Size	10.1 in. (257 mm) diagonal
Aspect Ratio	16:10 WUXGA
Resolution	1920 x 1200 pixels
Brightness	400 nits (cd/m ²)
Contrast	1000:1
Color Depth	24 bit, 16.7M colors
Illumination	Edgelit LED with auto brightness control
Viewing Angle	±80° horizontal, ±80° vertical
Touch Screen	Projected capacitive, 5-point multitouch capable

Buttons

Virtual Buttons	(6) Virtual buttons in collapsible universal tool bar, per-button show/hide, preconfigured with icons for Power, Home, Lights, Up, Down, and Microphone
Reset	Pin hole on rear panel for hardware reset

Audio

Features	Built-in speakers for touch feedback and alerts
-----------------	---

Connectors

LAN PoE	(1) 8-pin RJ-45 connector, female, with 2 LED indicators; 100BASE-TX Ethernet port; PoE+ PD port; Green and yellow LEDs indicate Ethernet port status
USB	(2) USB Type-A connectors, female; USB 2.0 host ports; For optional room scheduling accessories

NOTE: The touch screen supports the use of a single light bar or status indicator accessory only. The [RFID-USB](#) card reader accessory can be connected to the second USB port.

Power

PoE (Power over Ethernet)	IEEE 802.3at Type 2 compliant PoE+ PD (Powered Device); Normally requests 15 W from an 802.3at Type 2 PSE with LLDP advanced power management; With room scheduling and USB enabled, requests 18 W from an 802.3at Type 2 PSE with LLDP; Requests 30 W (PoE+ Class 4) from an 802.3at Type 2 PSE without LLDP; Requests 15.4 W (PoE Class 0) from an 802.3af (or 802.3at Type 1) PSE
----------------------------------	--

NOTE: Enabling the USB port requires use of an 802.3at Type 2 PoE+ PSE.

Environmental

Temperature	41 to 104°F (5 to 40°C)
Humidity	10% to 90% RH (noncondensing)
Heat Dissipation	49 BTU/hr

Construction

Housing	Plastic, smooth black or white finish, edge-to-edge glass with black or white surround
Mounting	Surface mount over a 2 or 3-gang US electrical box, 2-gang European (DIN 49073) electrical box, or 2-gang UK (BS 4662) electrical box; Lectern mount over a 2 in. H x 3-3/4 in. W (51 mm H x 96 mm W) cutout; 1-3/8 in. (35 mm) minimum mounting depth; Wall mount, surface mount, and rack options available separately

Dimensions

Height	5.87 in. (149 mm)
Width	10.18 in. (259 mm)
Depth	2.28 in. (58 mm)

Weight

1.61 lb (730 g)

Compliance

Regulatory Model: M201923003
IC, CE, FCC Part 15 Class B digital device

Dimension Drawings

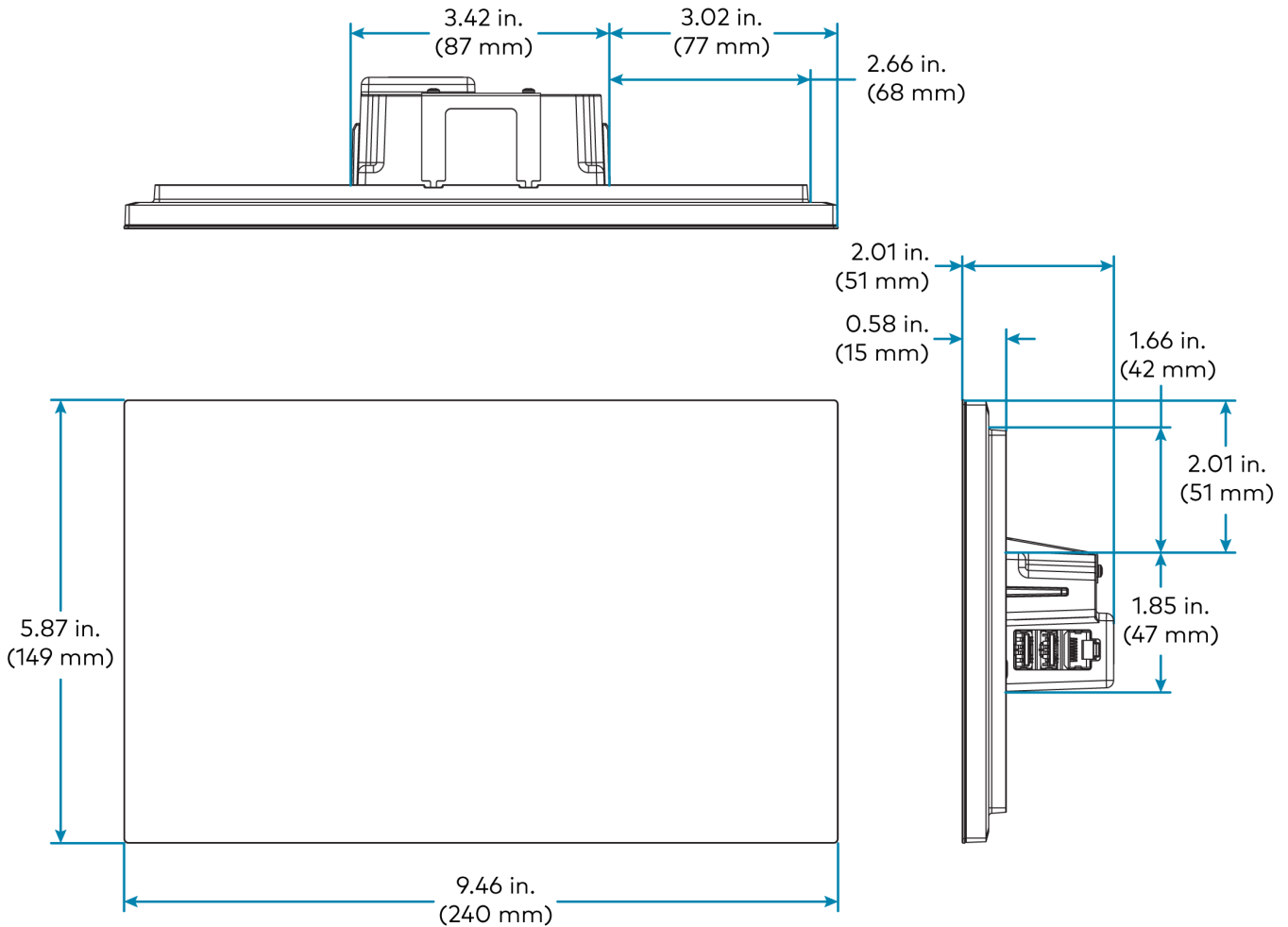

Notes:

1. Microsoft determines the functionality and appearance of the Microsoft Teams room scheduling application. Refer to the Microsoft website for more information.
2. Additional subscriptions and/or licenses may be required. Refer to the Microsoft website for details about the capabilities and requirements of its scheduling application and services. The TSS-1070-T cannot be interfaced with a control system and cannot be custom programmed for any other functionality. An internet connection is required.
3. The TSS-1070-T must be powered by a PoE+ power source when a light bar or hallway sign is connected. Refer to the Accessories section for a list of all available options. Refer to each accessory's spec sheet for further information.
4. Bluetooth technology is used solely for proximity detection and does not transmit or receive any control, multimedia, or personal data. Crestron Bluetooth beacons are only visible to Bluetooth enabled devices that are specifically programmed and configured to work with them.
5. The TSW-UMB-70 is also compatible with older TSW-UMB-PMK series preconstruction mounting kits and TSW-BBI series back boxes, allowing the TSS-1070-T to be installed in place of a previous generation touch screen.

TSS-1070-Z Specifications

Product specifications for the TSS-1070-Z are provided below.

Product Specifications

Room Scheduling Support

Zoom Rooms® App	Includes native support for Zoom Rooms scheduling application ^{1,2}
Additional Apps	Includes support for Crestron and various third-party scheduling apps

Languages

Crestron Fusion® Software	Chinese (Simplified), Chinese (Traditional), Danish, Dutch (Netherlands), English (US), English (UK), French, German, Hebrew, Italian, Japanese, Korean, Norwegian, Portuguese (Brazil), Portuguese (Portugal), Russian, Spanish, Swedish
----------------------------------	---

NOTE: Only a subset of these languages are available while running the Zoom Rooms application.

Wired Communications

Ethernet	100 Mbps, auto switching, auto negotiating, auto discovery, full/half duplex, TCP/IP, UDP/IP, DHCP, SSL, TLS, SSH, SFTP (SSH File Transfer Protocol), IEEE 802.1X, SNMP, HTTPS, IPv4 or IPv6, Active Directory® service authentication, HTTPS web browser setup, XiO Cloud® client, IEEE 802.3at compliant
USB	USB 2.0 host for light bar or hallway sign ³

Wireless Communications

Transceiver	IEEE 802.11a/b/g/n/ac Wi-Fi (2.4 or 5 GHz 2-way RF), static IP or dynamic IP via DHCP
Security	64 and 128-bit WEP, WPA and WPA2-PSK with TKIP and AES
Range	Up to 50 ft (15 m), subject to site-specific conditions
Bluetooth® Hardware	Crestron Bluetooth beacon ⁴

Touch Screen Display

Display Type	TFT active matrix color LCD
Size	10.1 in. (257 mm) diagonal
Aspect Ratio	16:10 WUXGA
Resolution	1920 x 1200 pixels
Brightness	400 nits (cd/m ²)
Contrast	1000:1
Color Depth	24 bit, 16.7M colors
Illumination	Edgelit LED with auto brightness control
Viewing Angle	±80° horizontal, ±80° vertical

Touch Screen Projected capacitive, 5-point multitouch capable

Buttons

Virtual Buttons (6) Virtual buttons in collapsible universal tool bar, per-button show/hide, preconfigured with icons for Power, Home, Lights, Up, Down, and Microphone

Reset Pin hole on rear panel for hardware reset

Audio

Features Built-in speakers for touch feedback and alerts

Connectors

LAN PoE (1) 8-pin RJ-45 connector, female, with 2 LED indicators;
100BASE-TX Ethernet port;
PoE+ PD port;
Green and yellow LEDs indicate Ethernet port status

USB (2) USB Type-A connectors, female;
USB 2.0 host ports;
For optional room scheduling accessories

NOTE: The touch screen supports the use of a single light bar or status indicator accessory only. The [RFID-USB](#) card reader accessory can be connected to the second USB port.

Power

PoE (Power over Ethernet) IEEE 802.3at Type 2 compliant PoE+ PD (Powered Device);
Normally requests 15 W from an 802.3at Type 2 PSE with LLDP advanced power management;
With room scheduling and USB enabled, requests 18 W from an 802.3at Type 2 PSE with LLDP;
Requests 30 W (PoE+ Class 4) from an 802.3at Type 2 PSE without LLDP;
Requests 15.4 W (PoE Class 0) from an 802.3af (or 802.3at Type 1) PSE

NOTE: Enabling the USB port requires use of an 802.3at Type 2 PoE+ PSE.

Environmental

Temperature	41 to 104°F (5 to 40°C)
Humidity	10% to 90% RH (noncondensing)
Heat Dissipation	49 BTU/hr

Construction

Housing	Plastic, smooth black or white finish, edge-to-edge glass with black or white surround
Mounting	Surface mount over a 2 or 3-gang US electrical box, 2-gang European (DIN 49073) electrical box, or 2-gang UK (BS 4662) electrical box; Lectern mount over a 2 in. H x 3-3/4 in. W (51 mm H x 96 mm W) cutout; 1-3/8 in. (35 mm) minimum mounting depth; Wall mount, surface mount, and rack options available separately

Dimensions

Height	5.87 in. (149 mm)
Width	10.18 in. (259 mm)
Depth	2.28 in. (58 mm)

Weight

1.61 lb (730 g)

Compliance

Regulatory Model: M201923003
IC, CE, FCC Part 15 Class B digital device

Dimension Drawings

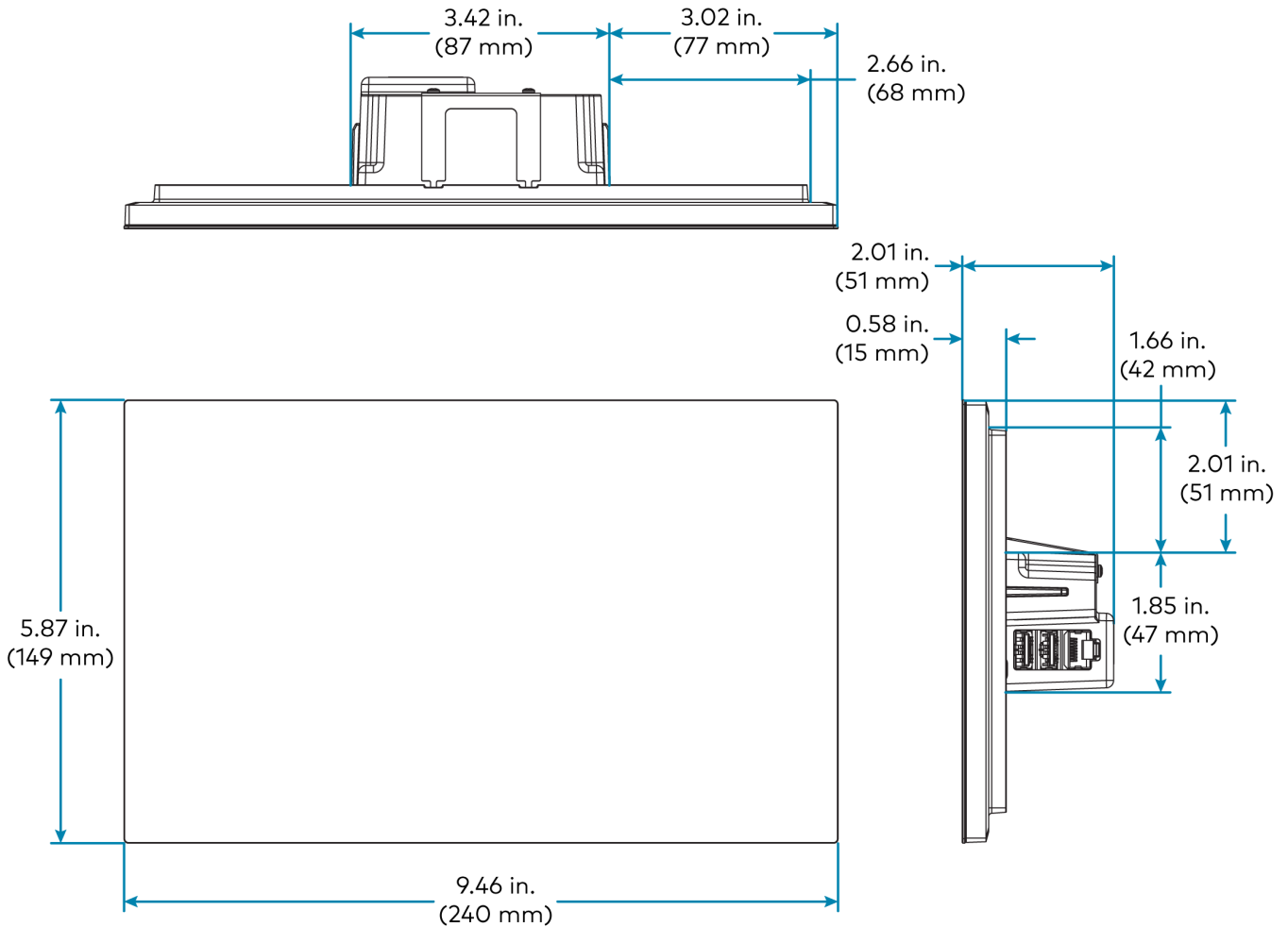

Notes:

1. Zoom determines the functionality and appearance of the Zoom Rooms® room scheduling application. Refer to the Zoom® website for more information.
2. Additional subscriptions and/or licenses may be required. Refer to the Zoom website for details about the capabilities and requirements of its scheduling application and services. The TSS-1070-Z cannot be interfaced with a control system and cannot be custom programmed for any other functionality. An internet connection is required.
3. The TSS-1070-Z must be powered by a PoE+ power source when a light bar or hallway sign is connected. Refer to the Accessories section for a list of all available options. Refer to each accessory's spec sheet for further information.
4. Bluetooth technology is used solely for proximity detection and does not transmit or receive any control, multimedia, or personal data. Crestron Bluetooth beacons are only visible to Bluetooth enabled devices that are specifically programmed and configured to work with them.
5. The TSW-UMB-70 is also compatible with older TSW-UMB-PMK series preconstruction mounting kits and TSW-BBI series back boxes, allowing the TSS-1070-Z to be installed in place of a previous generation touch screen.

Installation

Use the following procedures to install the TSS-770 and TSS-1070 touch screens.

Install the Mounting Bracket

The TSS-770 and TSS-1070 install over a standard 2-gang or 3-gang U.S. electrical box, a 2-gang European electrical box, or a 2-gang U.K. electrical box. The touch screen also installs into drywall.

NOTES:

- Additional mounting options are possible using the following mounting accessories. For more information, refer to the product pages at www.crestron.com.
 - TSW-UMB-70 universal mounting bracket
 - TSW-UMB-70-PMK preconstruction mounting kit
 - TSW-UMB-70-BBI wall mount back box
 - TSW-770/1070-MSMK series multisurface mounting kits
 - TSW-770/1070-MUMK mullion mounting kit
 - TSW-770/1070-RMB series retrofit mounting brackets
 - TSW-770/1070-RMK series rack mount kits
- Installing the mounting bracket to an electrical box is required only if one of the mounting solutions above is not used. Refer to the documentation for your chosen mounting solution at www.crestron.com/manuals.

Electrical Box Mounting

To mount the touch screen into an electrical box, use the appropriate screws (four 6-32 x 3/4 in. screws, four M3 x 16 mm screws, or two M3.5 x 25 mm screws) to attach the mounting bracket to the electrical box as shown in the following illustrations:

NOTE: For U.S. installations, use a #2 Phillips screwdriver. For European or U.K. installations, use a #1 Phillips screwdriver.

- For U.S. installations, use the four 6-32 x 3/4 in. screws.

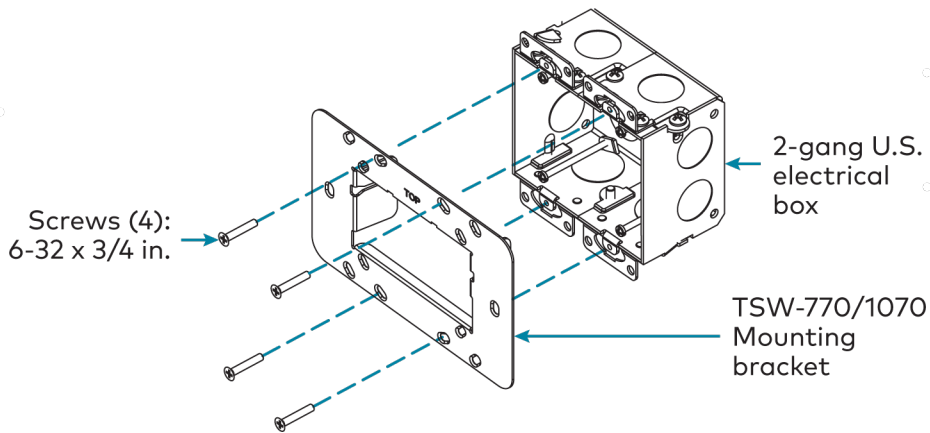

- For European installations, use the four M3 x 16 mm screws.

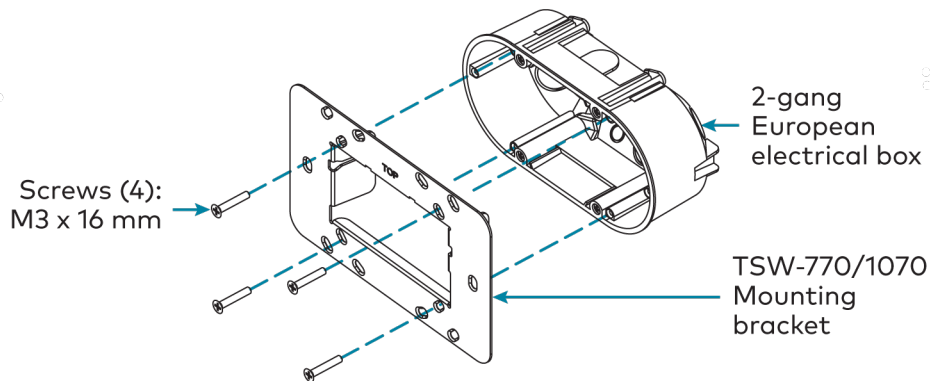

- For U.K. installations (not pictured), use the two M3.5 x 25 mm screws to attach the mounting bracket to the electrical box. Insert the screws through the center openings in the left and right sides of the mounting bracket.

Drywall Mounting

Mounting hardware is provided with the touch screen for drywall installations without an electrical box. Using this hardware will ensure that the bracket is completely flush with the touch screen to provide maximum magnetic force.

To install the mounting bracket into drywall:

1. Using the inside of the mounting bracket as a template, cut a 2-1/8 x 3-5/8 in. (54 x 92 mm) hole into the drywall. Ensure the template is level prior to cutting the hole.
2. Align the mounting bracket with the cutout and ensure it is level.
3. Use one of the anchors to make a center mark in the drywall through the four 2-gang openings in the template. Refer to the image below for the required mounting holes.
4. Screw the four anchors into the drywall using the center marks as a reference.
5. Attach the mounting bracket to the anchors using the four 6-AB x 1 in. screws as shown in the image below.

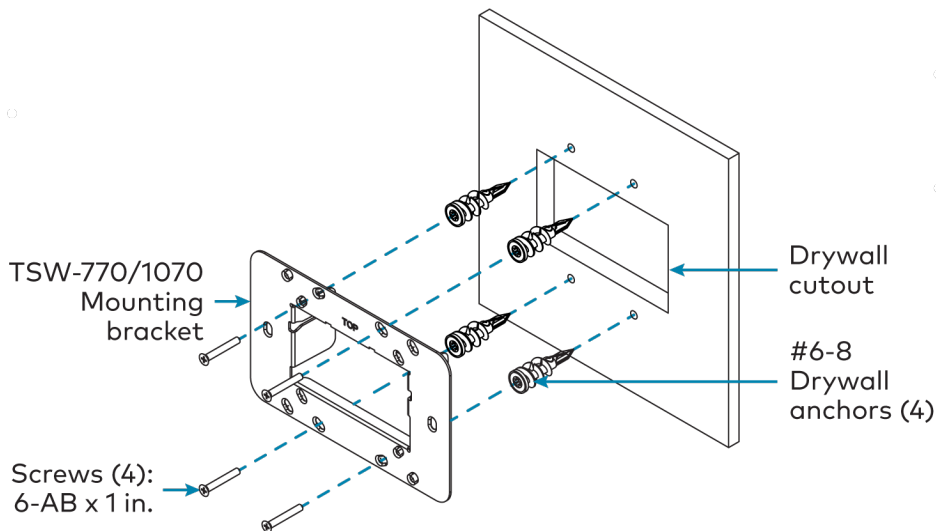

Install the Security Bracket (Optional)

The included security bracket may be attached to the touch screen to prevent unauthorized removal after installation. The security bracket snaps into place behind the mounting bracket so that the touch screen cannot be removed without using the included release key.

Use the two M2 x 4 mm screws to attach the security bracket to the touch screen rear housing as shown in the following illustration.

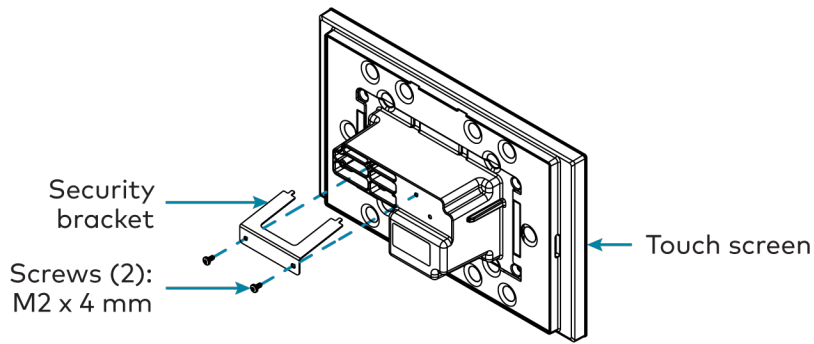

To remove the touch screen after installation, use the included release key to push down on the security bracket release tabs as shown in the following illustration while gently pulling the touch screen away from the mounting bracket.

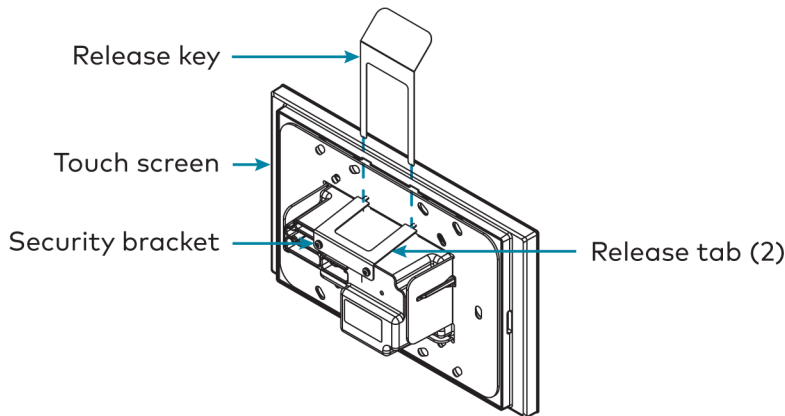

Connect the Touch Screen

Route all necessary cables through the rear of the mounting bracket, and then make connections to the side of the touch screen rear housing.

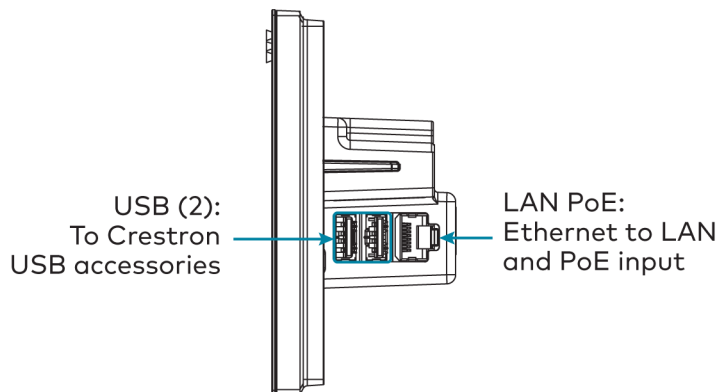

Observe the following when connecting the touch screen:

- Power and data connection is provided to the touch screen by a single Ethernet cable. A Crestron PoE (Power over Ethernet) power supply, such as the [PWE-4803RU](#), or a PoE-capable network switch is recommended (neither included).
- The USB ports are used to connect compatible Crestron LED accessories to the touch screen.

NOTE: The TSS-770 may use either PoE or PoE+ to supply power to compatible LED accessories over USB; the TSS-1070 requires at minimum PoE+ to supply power to LED accessories over USB.

- Apply power after all connections have been made.

Mount the Touch Screen

After all connections have been made, push the touch screen gently into the mounting bracket so that its rear housing is secured within the center opening of the mounting bracket.

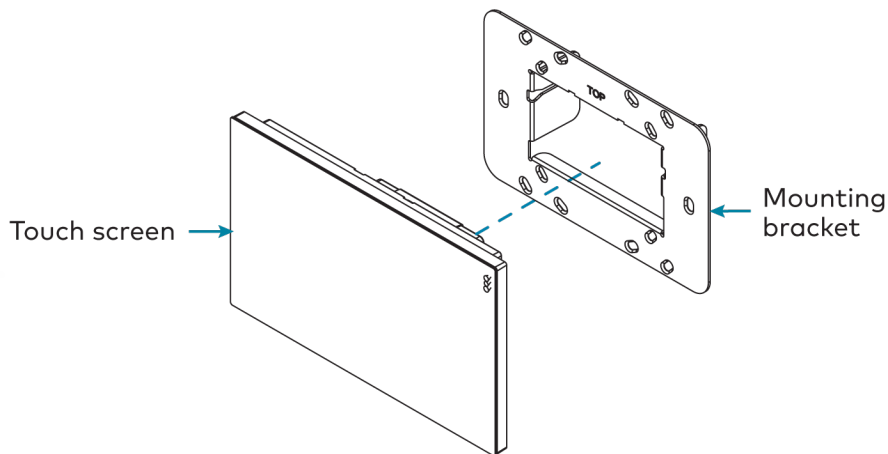

If the touch screen is not level after installation, pull it out of the mounting bracket and loosen the screws holding the bracket into place. This procedure allows the mounting bracket to be rotated slightly.

Once the mounting bracket has been repositioned, retighten the screws, reinstall the touch screen into the bracket, and ensure that the touch screen is now level.

NOTE: To clean or disinfect a touch screen display, use a soft, clean, damp (not wet) cloth with any commercially available non-ammonia glass cleaner or disinfectant cleaner. Bezels do not provide a complete watertight seal, so apply cleaning solution to the cloth rather than the surface of the touch screen. Wipe the touch screen clean and avoid ingress of moisture beneath the bezels.

Configure the Touch Screen

When power is applied for the first time, the touch screen boots with the Crestron room scheduling application selected by default. The touch screen may take up to two minutes to boot.

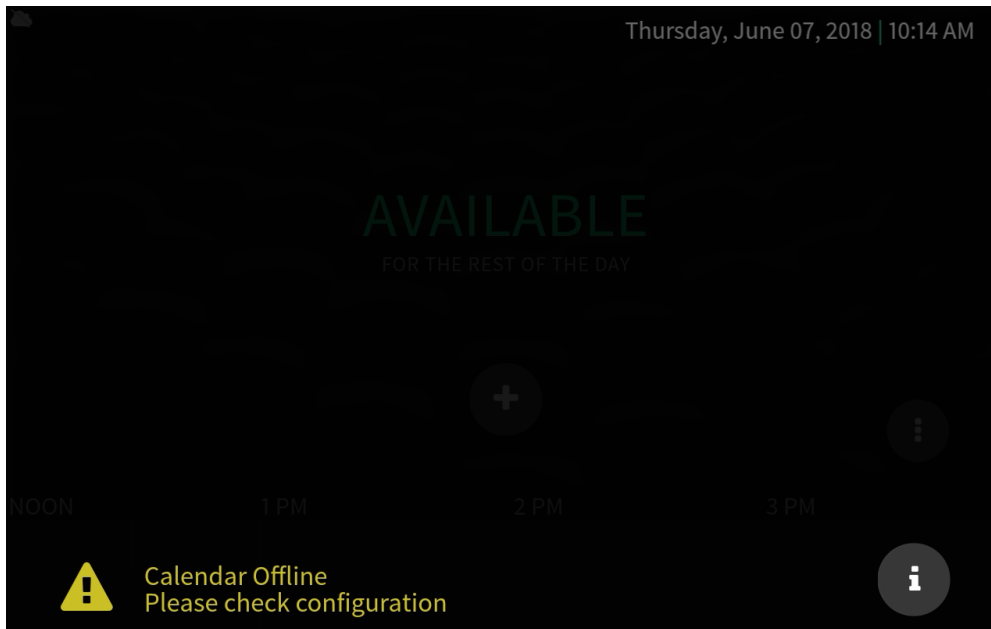

Device settings for the touch screen may be configured using the built-in setup screens or the web configuration interface. For more information on configuring the touch screen, refer to [Configuration on page 70](#).

NOTES:

- The touch screen included in the TSS-770-T-LB or TSS-1070-T-LB kits boots to the Microsoft Teams Panels scheduling application setup screen by default. To configure the application, refer to [Installation on page 57](#).
- The touch screen included in the TSS-770-Z-LB or TSS-1070-Z-LB kits boots to the Zoom Rooms scheduling application setup screen when the provided USB drive is installed before applying power. To configure the application, refer to [Configure the Zoom Rooms Application on page 68](#).
- To access the device setup screens for these touch screens, refer to [Access the Device Setup Screens on page 63](#).

Access the Device Setup Screens

To access the built-in setup screens, place five fingers on the display and hold for 15 seconds. The main Setup screen is displayed (TSS-770 shown).

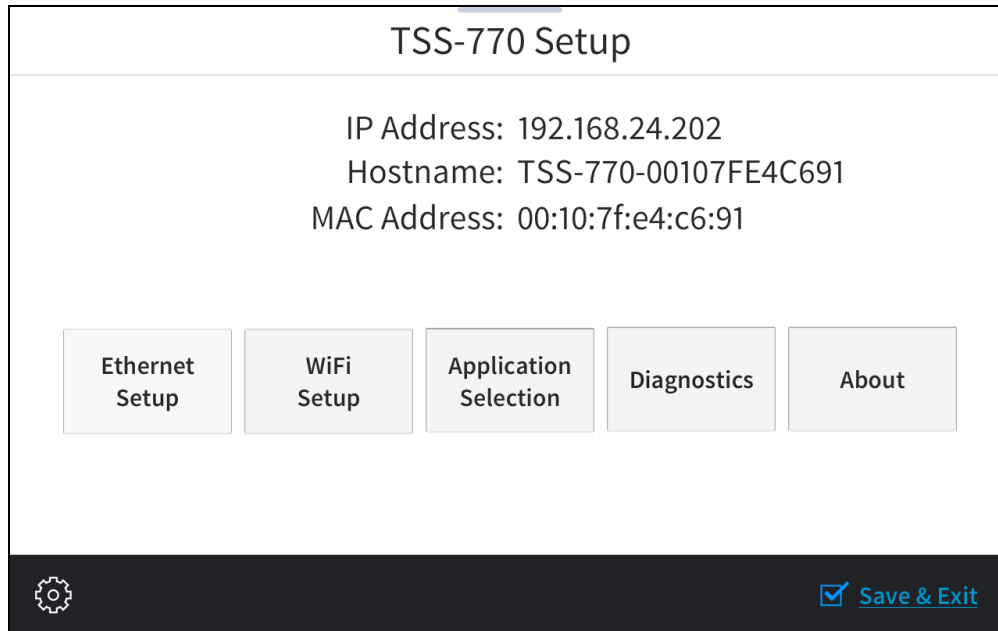

Use the setup screens to configure various settings for the touch screen, including Ethernet setup, scheduling application selection, Wi-Fi network setup, and diagnostics.

Access the Web Configuration Interface

The touch screen provides a web configuration interface that is used to view and configure various touch screen settings and to select a scheduling application. The interface can be accessed using the touch screen IP address or the XiO Cloud® service.

Touch Screen IP Address

To access the web configuration interface using the touch screen IP address:

1. Ensure that the touch screen is connected to the network.
2. Use the Device Discovery tool in Crestron Toolbox™ software to discover the touch screen and its IP address on the network.
3. Enter the touch screen IP address into a web browser.

XiO Cloud Service

The [XiO Cloud® service](#) allows supported devices across an enterprise to be managed and configured from one central and secure location in the cloud. Supported Crestron® devices are configured to connect to the service out of the box.

Use of the service requires a registered XiO Cloud account. To register for an XiO Cloud account, refer to www.crestron.com/Support/Tools/Licensing-Registration/XiO-Account-Registration.

NOTE: The device may be disconnected from the XiO Cloud service by navigating to the **Cloud Services** tab in Crestron Toolbox™ software (**Functions > Device Info > Cloud Services**). For details, refer to the Crestron Toolbox help file.

To connect the device to the XiO Cloud service:

1. Record the MAC address and serial number that are labeled on the shipping box or the device. The MAC address and serial number are required to add the device to the XiO Cloud service.

NOTE: If the device has multiple MAC addresses, use the MAC address that is providing the primary connection back to the network. For most devices, the Ethernet MAC address should be used. However, if your device is connecting to the network over a different protocol (such as Wi-Fi® communications), use the MAC address for that protocol instead.

2. Log in to your XiO Cloud account at portal.crestron.io.
3. Claim the device to the XiO Cloud service as described in the [XiO Cloud User Guide](#).

Select the device from the cloud interface to view its status and settings. The device may now also be managed and assigned to a group or room. For more information, refer to the [XiO Cloud User Guide](#).

NOTE: For XiO Cloud accounts with room-based licenses, the device must be added to a licensed room before its status and settings can be viewed.

Create an Admin Account

The first time the web configuration interface is accessed, a page is displayed asking the user to create an admin account. A similar message is displayed when connecting to the control system in Crestron Toolbox software if an admin account has not already been created.

To create an admin account:

1. Enter a username and password for the admin account in the appropriate text fields.

CAUTION: Do not lose the username and password for the admin account, as the control system must be reset to factory settings to regain access.

2. Select **OK** to create the admin account. The web configuration interface refreshes to show the standard login page.
3. Reenter the credentials created in step 1 and select **Sign In**.

NOTE: The username and password must also be entered when connecting from Crestron Toolbox or XPanel.

Set the Time Zone

The time zone must be set on the touch screen prior to selecting a scheduling application.

To set the time zone:

1. Access the web configuration interface using either the touch screen IP address or the XiO Cloud service.
2. Select the **Settings** tab.
3. Navigate to **System Setup > Time/Date**.
4. Select the time zone where the touch screen will be used from the **Time Zone** drop-down menu.
5. Select **Save Changes** on the top right of the screen.

Select an Application

The touch screen ships with various built-in scheduling applications. An application may be selected from the web configuration interface.

Certain TSS-70 series models are designed to run specific applications out of the box:

- The touch screen included in the TSS-770-T-LB or TSS-1070-T-LB kits runs the Microsoft Teams Panels scheduling application by default. For more information, refer to [Configure Microsoft Teams Panels on page 66](#).
- The touch screen included in the TSS-770-Z-LB or TSS-1070-Z-LB kits runs the Zoom Rooms scheduling application via the included USB drive. For more information, refer to [Configure the Zoom Rooms Application on page 68](#).
- Other supported applications can be configured to run on these touch screens through the local or web configuration interfaces.

NOTE: Applications can be selected and configured from the device setup screens or from the web configuration interface at any time. For more information, refer to [Application Selection on page 134](#).

To select a touch screen application:

1. Enter the touch screen IP address into a web browser to access the web configuration interface.
2. Navigate to **Settings > Applications**.
3. Select the desired scheduling provider from the **Application Mode** drop-down menu.
4. If necessary, enter any additional information (such as a registration URL) that is required for connecting to the scheduling provider.
5. Select **Save Changes** on the top right of the screen.
6. When prompted, restart the touch screen. The touch screen restarts with the selected scheduling mode running.

An application may also be selected using the **Application Selection** function on the main device Setup screen.

Configure Microsoft Teams Panels

The touch screen included in the TSS-770-T-LB or TSS-1070-T-LB kits ships with the Microsoft Teams Panels scheduling application running out of the box, with the **Language Selection** screen displayed upon initial boot. The application must be configured prior to use.

NOTE: A Microsoft Teams account is required for configuration. Refer to your IT administrator for assistance.

To set up the Microsoft Teams Panels scheduling application on the touch screen:

1. Select a language for the application on the **Language Selection** screen.

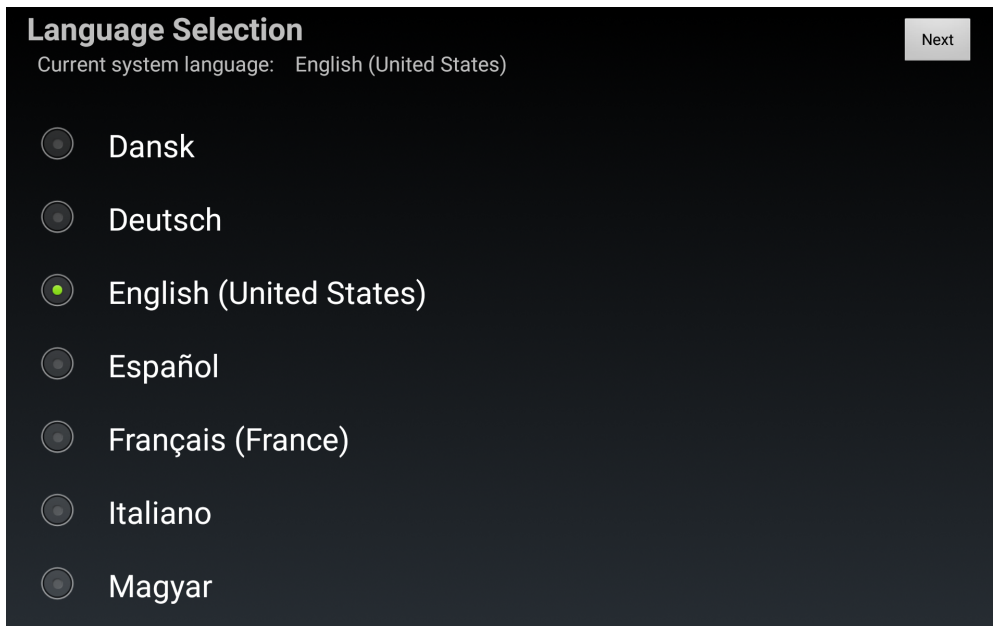

2. Tap **Next**. The **Time Zone Selection** screen is displayed.

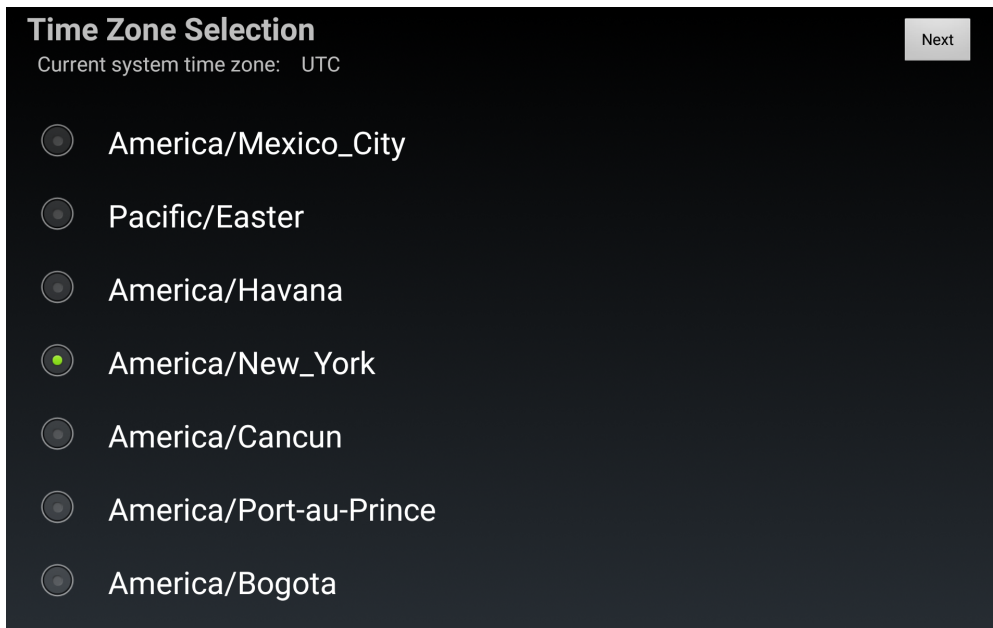

3. Select the time zone that will be used by the application on the **Time Zone Selection** screen.
4. Tap **Next**. A Microsoft Teams sign in screen is displayed.

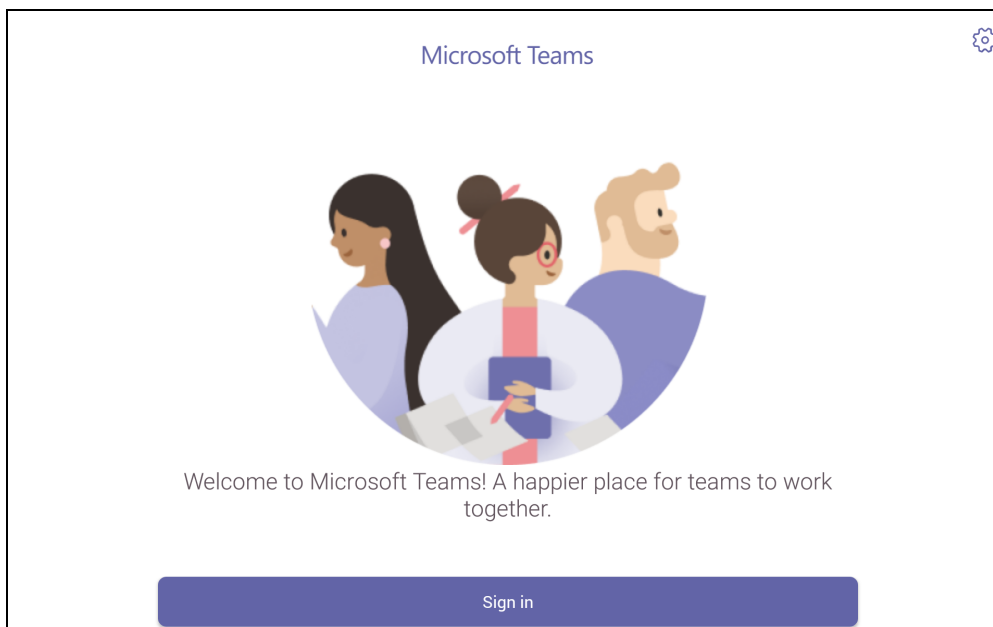

5. Tap **Sign In**.
6. Enter your Microsoft Teams username and password when prompted.
7. If two-factor authentication is enabled by your organization, follow the prompts provided to authenticate with the application.

Upon successful sign in, the scheduling calendar for your organization is displayed.

For more information on using Microsoft Teams, refer to <https://support.microsoft.com/en-us/teams>.

Configure the Zoom Rooms Application

The TSS-770-Z-LB and TSS-1070-Z-LB kits ship with a USB drive that boots the included touch screen directly into Zoom Rooms scheduling mode. The application must be configured prior to use.

NOTE: A Zoom Rooms account is required for configuration. Refer to your IT administrator for assistance.

To configure the Zoom Rooms application on the touch screen:

1. Insert the included USB drive into the touch screen USB port while the touch screen is powered off. Refer to [Connect the Touch Screen on page 60](#) to locate the USB port.

NOTE: If the USB drive is not inserted into the touch screen before power is applied, the touch screen will boot its default mode (Crestron Room scheduling) instead.

2. Apply power to the touch screen. The Zoom Rooms application user interface is displayed on the touch screen following the boot.

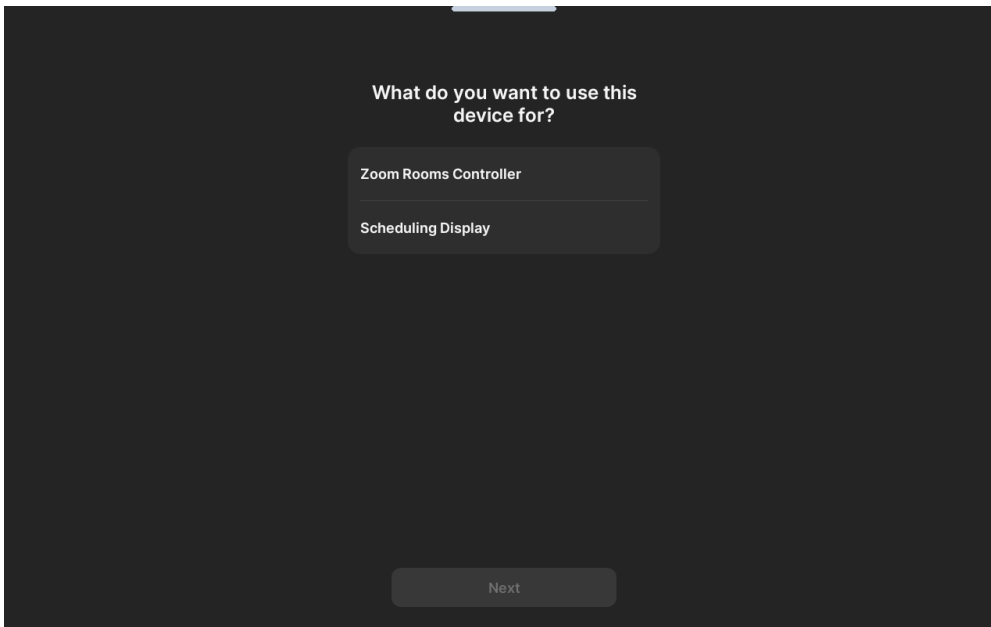

3. Select **Scheduling Display** from the provided menu, and then select **Next**. A screen for connecting to the Zoom Rooms PC is displayed.

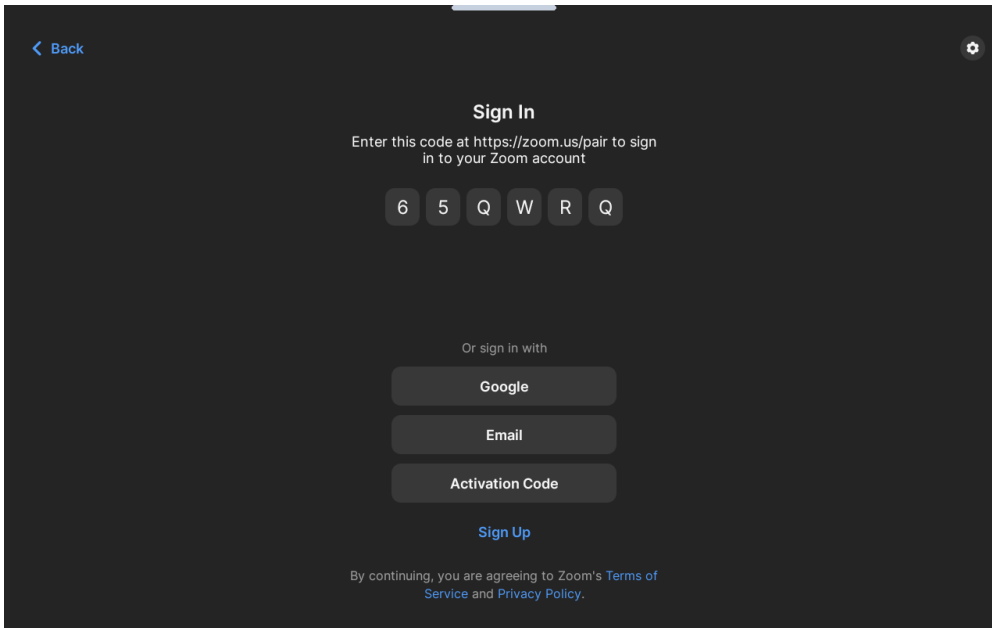

4. Pair the touch screen to your Zoom Rooms account using one of the following methods:
 - Enter the provided pairing code at zoom.us/pair after logging into your Zoom Rooms account.
 - Select **Google** to sign in to Zoom Rooms via a paired Google account using a web browser.
 - Select **Email** to sign in to Zoom Rooms by entering the account email address and password (supplied by your IT department).
 - Select **Activation Code** to sign into Zoom Rooms by entering the pairing code for the Zoom Rooms account (supplied by your IT department).
5. When prompted, confirm that the correct Zoom Rooms account is signing into the device.

If the account pairing is successfully, a notification appears confirming the registration success, and the application updates to display the scheduling display for the Zoom Rooms deployment.

For more information on setting up and using Zoom Rooms, refer to <https://support.zoom.us/hc/en-us/categories/200108436-Zoom-Rooms>.

Configuration

Prior to configuration, ensure the device is running the latest firmware. To update the firmware, refer to [Update Firmware on page 99](#).

When power is applied for the first time, the touch screen boots with the Crestron room scheduling application selected by default. The touch screen may take up to two minutes to boot.

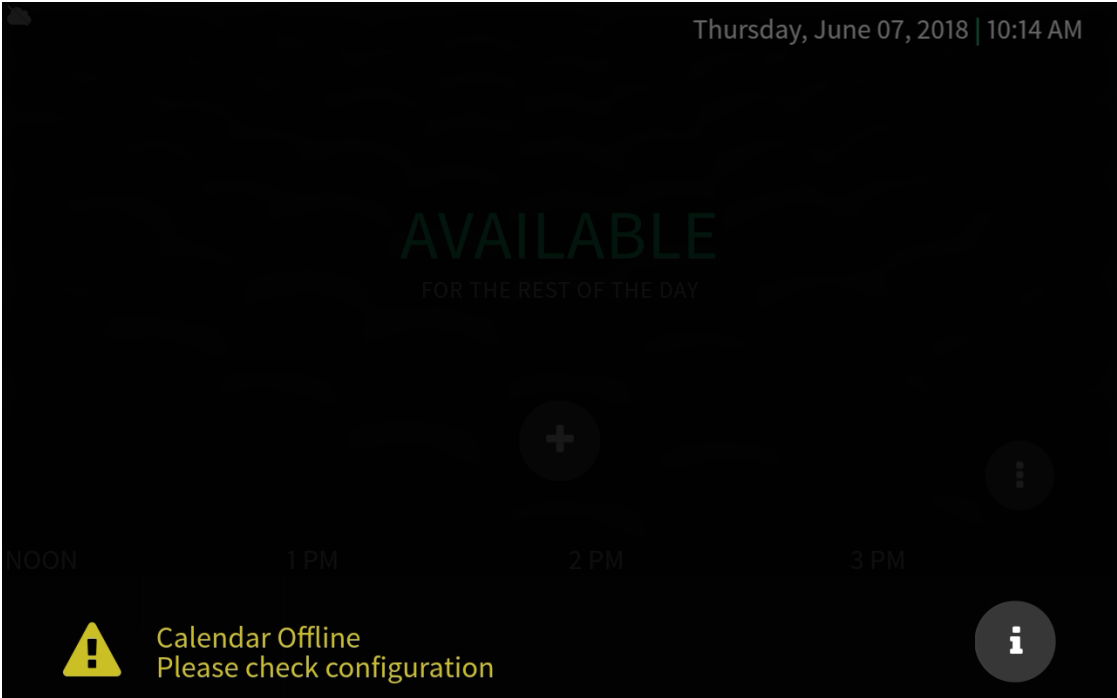

Place five fingers on the display and hold for 20 seconds to display the main Setup screen (TSS-770 shown).

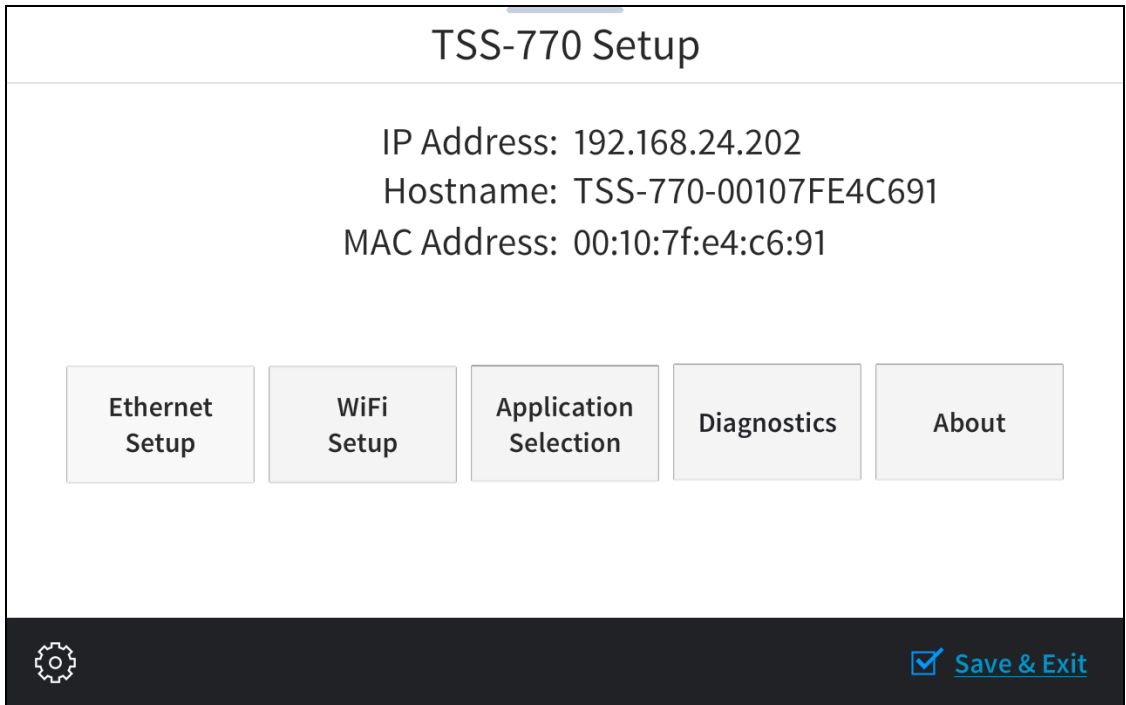

Device settings for the touch screen may be configured using the built-in setup screens or the web configuration interface.

- To configure the device using the built-in setup screens, refer to [Local Configuration on page 72](#).
- To configure the device using the web configuration interface, refer to [Web Configuration on page 97](#).

Local Configuration

Refer to the following sections for information about configuring the device locally using its built-in setup screens.

Access the Setup Screens

The setup screens enable basic configuration prior to regular operation of the touch screen.

To access the touch screen's built-in setup screens during regular operation, place five fingers on the display and hold for 15 seconds.

The main Setup screen is displayed (TSS-770 shown).

TSS-770 Setup Screen

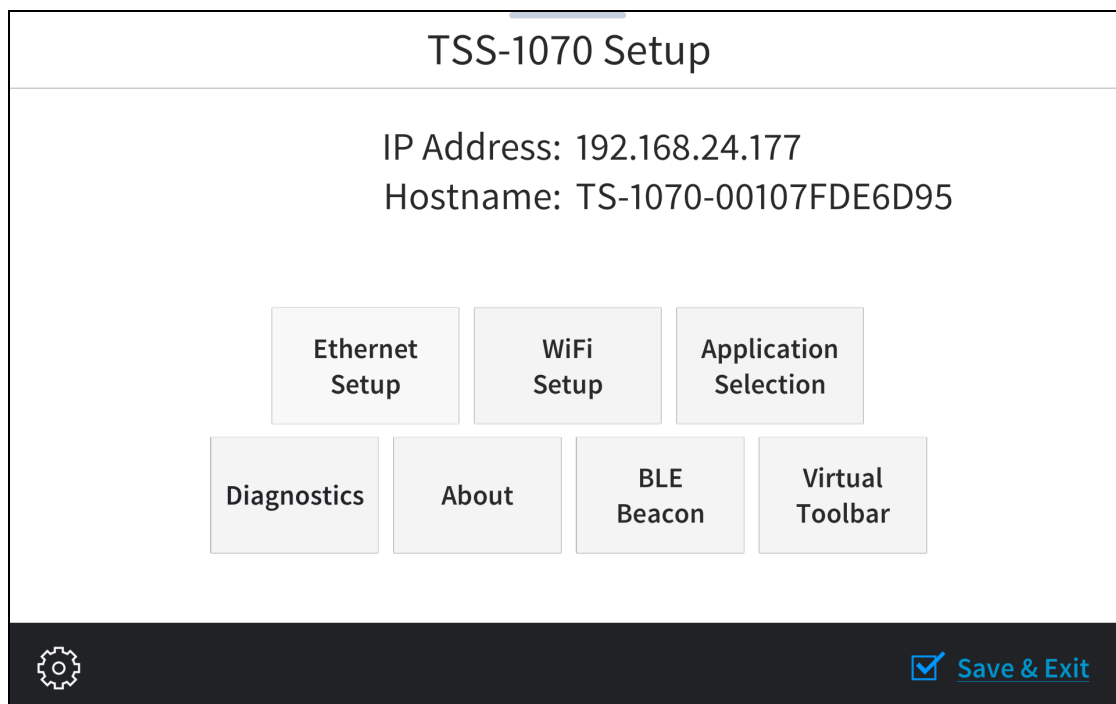

The Setup screen shows the IP address and host name of the touch screen and provides the following configuration selections:

- Buttons for Ethernet setup, application selection, Wi-Fi® network setup, diagnostics, Bluetooth® beacon configuration, and the virtual toolbar.
- An **About** button that provides information about the touch screen.

The functions of each button are detailed in the following sections.

NOTE: A toolbar is present on the bottom of all setup screens. The toolbar provides a gear button  that may be tapped to return to the Setup screen and a **Save & Exit** button that may be tapped to save all settings, to exit the setup screens, and to return to the selected scheduling application.

Ethernet Setup

Tap **Ethernet Setup** on the Setup screen to display the **Select Network Procotol** screen.

Select Network Protocol Screen

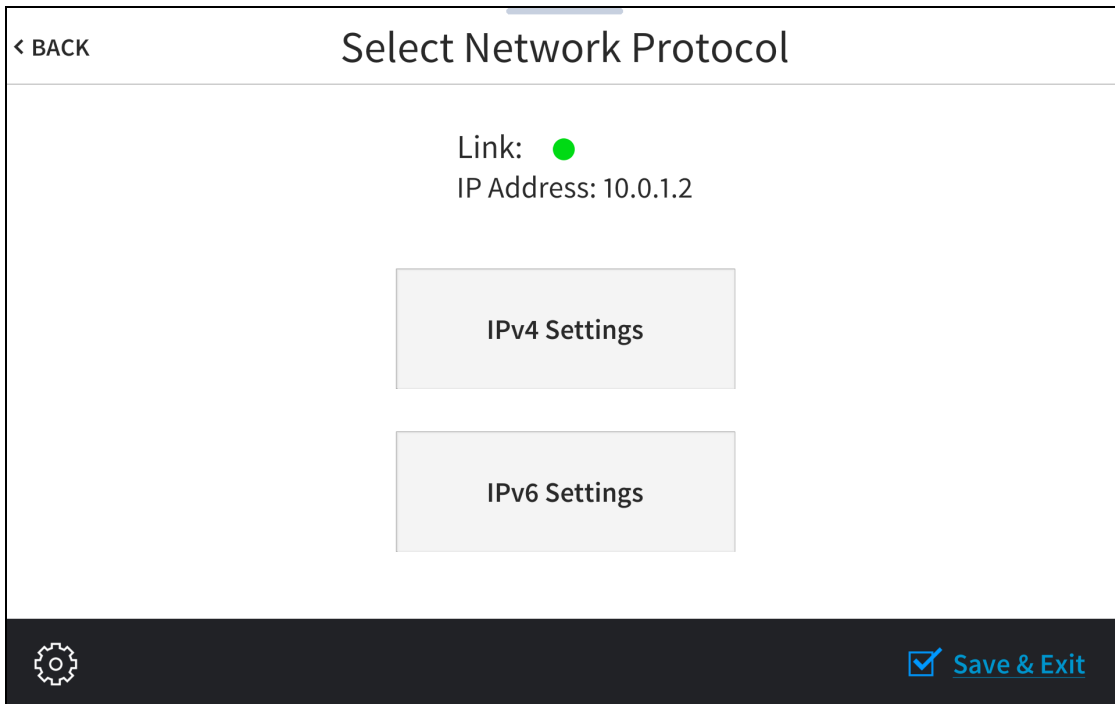

Tap **IPv4 Settings** or **IPv6 Settings** to configure IPv4 or IPv6 Ethernet settings for the touch screen, respectively.

Tap < **BACK** to return to the Setup screen.

IPv4 Settings

Tap **IPv4 Settings** on the **Select Network Protocol** screen to display the **IPv4 Ethernet Settings** screen.

< BACK IPv4 Ethernet Setup APPLY CHANGES REBOOT

Link: ●
MAC: 00:10:7f:da:64:00
IP Address: 10.0.1.2
Subnet Mask: 255.255.255.0
Default Router: 10.0.1.1
Primary DNS: 10.0.1.1
Secondary DNS:
Hostname: TSS-1070-001
Domain: localdomain

Ethernet IP Options
Set Static IP Address Settings

DHCP Enable
On Off

Set Hostname

LAN Access
On Off

Save & Exit

Use the **IPv4 Ethernet Setup** screen to view the touch screen IPv4 MAC and IP addresses, subnet mask address, default router address, primary and secondary DNS addresses, host name, and domain. A **Link** indicator is provided to indicate the status of the IPv4 Ethernet connection. (Green indicates that the Ethernet connection is active.)

The following buttons are provided for configuring IPv4 Ethernet settings:

- Tap **On** or **Off** under **LAN Access** to turn the IPv4 Ethernet adapter on or off. If **LAN Access** is set to **Off**, IPv4 Ethernet will not function and a Wi-Fi connection can be established.
- Tap **On** or **Off** under **DHCP Enable** to turn DHCP (Dynamic Host Configuration Protocol) on or off.

NOTE: DHCP is turned on by default.

- If DHCP is turned off, tap **Set Static IP Address Settings** to enter static IPv4 addresses manually.
- Tap **Set Hostname** to enter a new touch screen host name using an on-screen keyboard.
- Tap **APPLY CHANGES** to apply any new IPv4 Ethernet settings to the touch screen and to stay in setup mode.
- Tap **REBOOT** to exit setup mode and restart the touch screen.

To change a static IPv4 address, tap **Off** under **DHCP Enable**. Then, tap **Set Static IP Address Settings** to display the **IPv4 Static IP Setup** screen.

IPv4 Static IP Setup Screen

< BACK IPv4 Static IP Setup APPLY CHANGES REBOOT

[Touch a Setting to Edit](#)

Static IP address	0.0.0.0	Preferred DNS	0.0.0.0
Static Subnet Mask	0.0.0.0	Alternate Preferred DNS	0.0.0.0
Static Default Router	0.0.0.0		



 [Save & Exit](#)

To edit the static IP address, the static subnet mask, the static default router, the preferred DNS, or the alternate preferred DNS, tap the text field underneath the setting name.

The on-screen numeric keypad opens for the chosen setting.

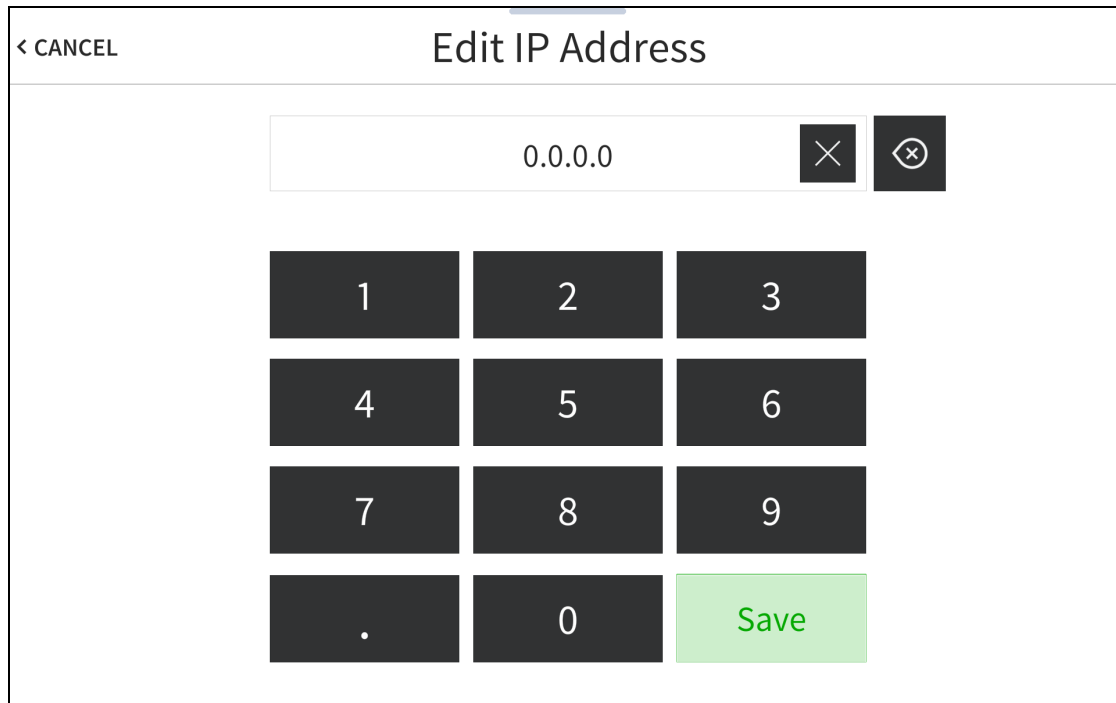
Edit IP Address On-Screen Numeric Keypad



- Use the keypad to make a new entry.
- Tap the clear button  in the text field to clear any previous entry.
- Tap the delete button  to delete the last digit.
- Tap **Save** to save a new entry or tap **< CANCEL** to discard any changes. The display returns to the **IPv4 Static IP Setup** screen.

After new settings have been saved, tap **APPLY CHANGES** on the **IPv4 Static IP Setup** screen to apply the new settings and stay in setup mode. Tap **REBOOT** to exit setup mode and restart the touch screen.

Tap **< BACK** to return to the **IPv4 Ethernet Setup** screen.

Tap **< BACK** on the **IPv4 Ethernet Setup** screen to return to the **Select Network Protocol** screen.

IPv6 Settings

Tap **IPv6 Settings** on the **Select Network Protocol** screen to display the **IPv6 Ethernet Settings** screen.

The screenshot shows the "IPv6 Ethernet Setup" screen. At the top left is a "< BACK" button. The title "IPv6 Ethernet Setup" is centered at the top. To the right of the title are "APPLY CHANGES" and "REBOOT" buttons. The screen is divided into two main sections. The left section contains the following labels and values: "Link:" with a green dot, "MAC: 00:10:7f:da:64:00", "IP Address 1: fe80::6a8c:d44:f5ad:6440/64", "IP Address 2:", "IP Address 3:", "Default Router: ::", "Primary DNS:", and "Secondary DNS:". The right section contains three main areas: "Ethernet IP Options" with a button "Set Static IP Address Settings", "IPv6 Enable" with a toggle switch set to "On", and a button "Set Hostname". At the bottom left is a gear icon, and at the bottom right is a "Save & Exit" button with a checkmark icon.

Use the **IPv6 Ethernet Setup** screen to view the touch screen IPv6 MAC and IP addresses, default router address, and primary and secondary DNS addresses. A **Link** indicator is provided to indicate the status of the IPv6 Ethernet connection. (Green indicates that the Ethernet connection is active.)

The following buttons are provided for configuring IPv6 Ethernet settings:

- Tap **On** or **Off** under **IPv6 Enable** to turn IPv6 addressing on or off.
- Tap **Set Static IP Address Settings** to enter static IPv6 addresses manually.
- Tap **Set Hostname** to enter a new touch screen host name using an on-screen keyboard.
- Tap **APPLY CHANGES** to apply any new IPv6 Ethernet settings to the touch screen and to stay in setup mode.
- Tap **REBOOT** to exit setup mode and restart the touch screen.

To change a static IPv6 address, tap **Set Static IP Address Settings** to display the **IPv6 Static IP Setup** screen.

IPv6 Static IP Setup Screen

< BACK IPv6 Static IP Setup APPLY CHANGES REBOOT

[Touch a Setting to Edit](#)

Static IP address

Preferred DNS

Static Default Router

Alternate Preferred DNS



 [Save & Exit](#)

To edit the static IP address, the static default router, the preferred DNS, or the alternate preferred DNS, tap the text field underneath the setting name.

The on-screen numeric keypad opens for the chosen setting.

Edit IPv6 Address On-Screen Numeric Keypad

The screenshot shows the 'Edit IPv6 Address' interface. At the top left is a '< CANCEL' button. The title 'Edit IPv6 Address' is centered at the top. Below the title is a text input field with a clear button (X) and a delete button (X with a left arrow). Below the text field is a numeric keypad with two rows. The first row contains digits 1 through 0. The second row contains a colon (:), lowercase letters a through f, and a forward slash (/). Below the keypad is a green 'Save' button.

- Use the keypad to make a new entry.
- Tap the clear button  in the text field to clear any previous entry.
- Tap the delete button  to delete the last digit.
- Tap **Save** to save a new entry or tap **< CANCEL** to discard any changes. The display returns to the **IPv6 Static IP Setup** screen.

After new settings have been saved, tap **APPLY CHANGES** on the **IPv6 Static IP Setup** screen to apply the new settings and stay in setup mode. Tap **REBOOT** to exit setup mode and restart the touch screen.

Tap **< BACK** to return to the **IPv6 Ethernet Setup** screen.

Tap **< BACK** on the **IPv6 Ethernet Setup** screen to return to the **Select Network Protocol** screen.

Application Selection

Tap **Application Selection** on the Setup screen to display the **Application Setup** screen.

Application Setup Screen

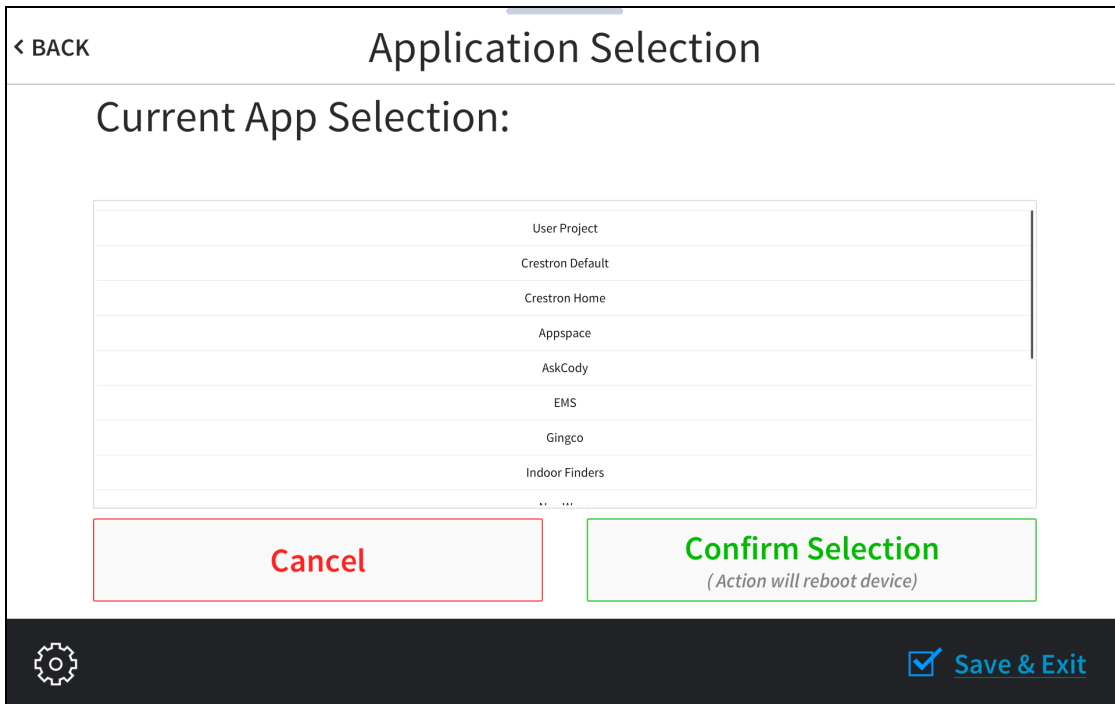

Use the **Application Selection** screen to select a scheduling application from the available selections. Swipe up or down through the list, and then tap an application to select it. Tap **Confirm Selection** to confirm the selection or tap **Cancel** to return to the previous screen. Once confirmed, the touch screen restarts with the new application running.

NOTE: Each application uses a unique setup procedure for registering and configuring the application. For more information on setting up each application, refer to [Application Selection on page 134](#).

Tap **< BACK** to return to the Setup screen.

Wi-Fi Setup

Tap **Wi-Fi Setup** on the Setup screen to display the **Wi-Fi Setup** screen.

Wi-Fi Setup Screen

The screenshot shows the 'WiFi Setup' screen with a title bar containing '< BACK', 'WiFi Setup', 'APPLY CHANGES', and 'REBOOT'. The screen is divided into two main sections. The left section displays network details: 'Link' with a green indicator, 'WiFi MAC: 00:00:00:00:00:00', 'IP Address: 10.0.255.0', 'Subnet Mask: 255.255.255.0', 'Default Router: 10.0.1.0', 'Primary DNS: 10.0.1.0', 'Secondary DNS:', 'Hostname: TSS-1070-001', 'Domain: localdomain', 'SSID: Ham1', 'BSSID: b8:c7:5d:07:f7:b8', and 'Radio Band: G'. The right section contains 'WiFi IP Options' with a 'Set Static IP Address Settings' button, 'DHCP Enable' with 'On' and 'Off' buttons, 'Set Hostname', 'Select WiFi Access Point', and 'Manage WiFi Access Points'. At the bottom right, there is a 'WiFi Access' section with 'On' and 'Off' buttons. A 'Save & Exit' button with a checkmark icon is located at the bottom right of the screen.

Use the **Wi-Fi Setup** screen to view the Wi-Fi network MAC and IP addresses, subnet mask address, default router address, primary and secondary DNS addresses, host name, domain, and various details about the Wi-Fi connection. A **Link** indicator is provided to indicate the status of the Wi-Fi connection. (Green indicates that the Wi-Fi connection is active.)

NOTE: Ethernet must be disabled before a Wi-Fi connection can be configured.

The following buttons are provided for configuring Wi-Fi settings:

- Tap **On** or **Off** under **Wi-Fi Access** to turn the Wi-Fi adapter on or off. If **Wi-Fi Access** is set to **Off**, Wi-Fi will not function and an Ethernet connection can be established.
- Tap **On** or **Off** under **DHCP Enable** to turn DHCP (Dynamic Host Configuration Protocol) on or off.

NOTE: DHCP is enabled on the touch screen by default.

- If DHCP is turned off, tap **Set Static IP Address Settings** to enter static IP addresses manually.
- Tap **Set Hostname** to enter a new touch screen host name using an on-screen keyboard.
- Tap **APPLY CHANGES** to apply any new Wi-Fi settings to the touch screen and to stay in setup mode.
- Tap **REBOOT** to exit setup mode and restart the touch screen.

To change a static IP address, tap **Off** under **DHCP Enable**. Then, tap **Set Static IP Address Settings** to display the **Wi-Fi Static IP Setup** screen.

Wi-Fi Static IP Setup Screen

< BACK WiFi Static IP Setup APPLY CHANGES REBOOT

[Touch a Setting to Edit](#)

Static IP address	0.0.0.0	Preferred DNS	0.0.0.0
Static Subnet Mask	0.0.0.0	Alternate Preferred DNS	0.0.0.0
Static Default Router	0.0.0.0		

 [Save & Exit](#)



To edit the static IP address, the static subnet mask, the static default router, the preferred DNS, or the alternate preferred DNS, tap the text field underneath the setting name.

The on-screen numeric keypad opens for the chosen setting.

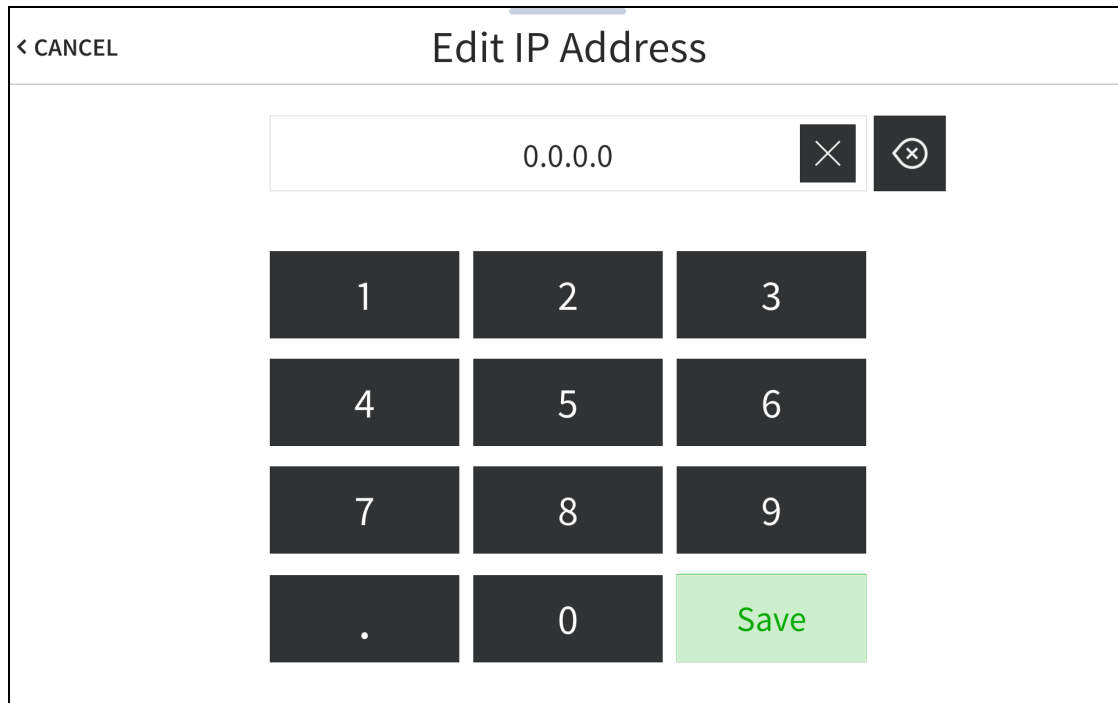
Edit IP Address On-Screen Numeric Keypad



The screenshot shows a mobile application interface titled "Edit IP Address". At the top left is a back arrow and the word "CANCEL". The title "Edit IP Address" is centered at the top. Below the title is a text input field containing "0.0.0.0". To the right of the text field are two buttons: a square button with a white "X" on a dark background, and a square button with a white "X" inside a circle on a dark background. Below the text field is a numeric keypad with four rows of buttons. The first row contains buttons for "1", "2", and "3". The second row contains buttons for "4", "5", and "6". The third row contains buttons for "7", "8", and "9". The fourth row contains buttons for ".", "0", and a green "Save" button.

- Use the keypad to make a new entry.
- Tap the clear button  in the text field to clear any previous entry.
- Tap the delete button  to delete the last digit.
- Tap **Save** to save a new entry or tap **< CANCEL** to discard any changes. The display returns to the **Static IP Ethernet Setup** screen.

After new settings have been saved, tap **APPLY CHANGES** on the **WiFi Static IP Setup** screen to apply the new settings and stay in setup mode. Tap **REBOOT** to exit setup mode and restart the touch screen.

Tap **< BACK** to return to the **Wi-Fi Setup** screen.

Tap **< BACK** on the **Wi-Fi Setup** screen to return to the Setup screen.

Select a Wi-Fi Access Point

On the **Wi-Fi Setup** screen, tap **Select Wi-Fi Access Point**. The **Connect to a Wi-Fi Access Point (1-2-3)** screen is displayed.

Connect to a Wi-Fi Access Point (1-2-3) Screen

The screenshot shows the 'Connect to a WiFi Access Point (1-2-3)' screen. At the top left is a '< BACK' button. The title is 'Connect to a WiFi Access Point (1-2-3)'. The screen is divided into three sections: 'Step 1 - Select a WAP' on the left, 'Step 2 - Touch to Edit WAP Settings' on the right, and 'Step 3 - Make this my Access Point' in a box at the bottom right. Step 1 shows a list of WAPs with 'lan's Guest Network' selected and an 'Add new...' option at the top. Below the list is the text '(Updates within 30 seconds)'. Step 2 shows three input fields: 'WAP Name (SSID):', 'Security:' (with 'Open' selected), and 'Password:'. Step 3 is a button. At the bottom, there is a gear icon on the left and a 'Save & Exit' button on the right.

Use the **Connect to a Wi-Fi Access Point (1-2-3)** screen to connect the touch screen to an existing WAP that is in range or to configure a new WAP. Any WAPs that are in range and discoverable are displayed under **Step 1 - Select a WAP** upon successful discovery.

To set up a Wi-Fi network connection:

1. Select the desired WAP from the options shown underneath **Step 1 - Select a WAP**. If the desired WAP is not shown, tap **Add New**.

NOTE: The **WAP Name (SSID)** and **Security** fields are populated automatically when a discovered WAP is selected. This information must be entered manually when adding a new WAP.

2. Tap the **WAP Name (SSID)** text field to display an on-screen keyboard.
3. Enter or modify the WAP name if necessary, and then tap **SAVE**.

4. Tap the **Security** text field to display the **Wi-Fi Encryption Settings** screen.

Wi-Fi Encryption Settings

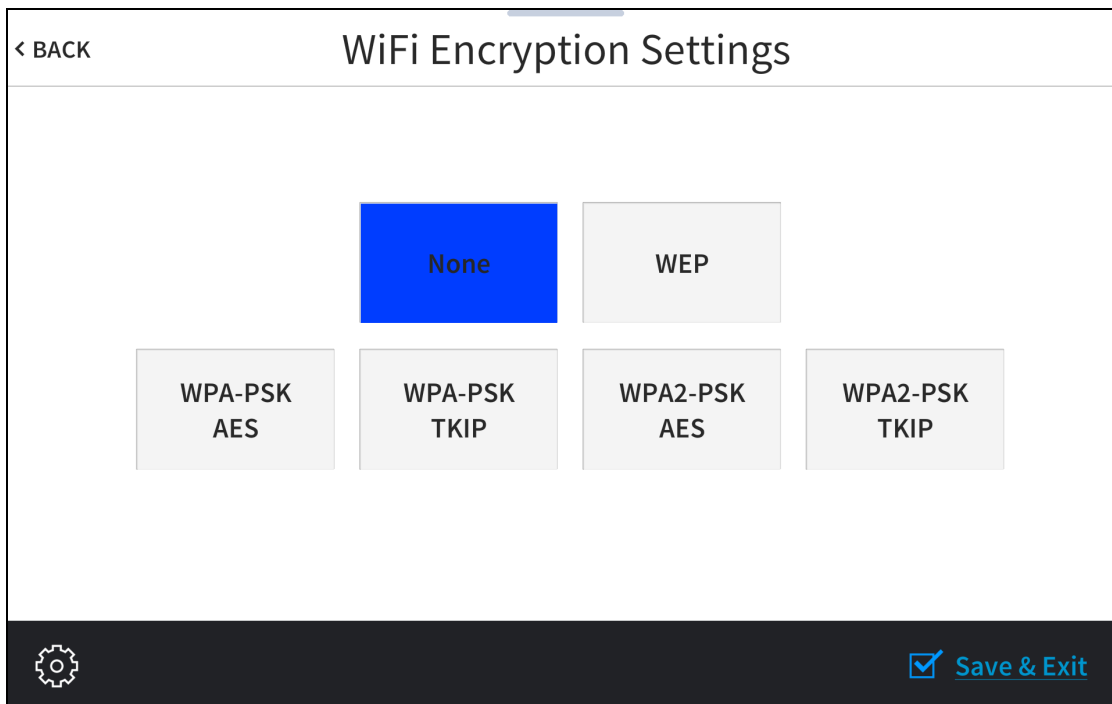

5. Tap the appropriate encryption type used by the WAP, and then tap **< BACK**.
6. Tap the **Password** text field to display an on-screen keyboard.
7. Enter the password used to connect to the WAP, and then tap **SAVE**.
8. Tap **Step 3 - Make this my Access Point**. The **Wi-Fi WAP Selection** screen is displayed.

The touch screen attempts to connect to the WAP using the provided credentials. If a connection is established, connection details for the WAP are shown with a green check mark to the left of **Current Connection**.

Wi-Fi WAP Selection Screen (Connection Successful)

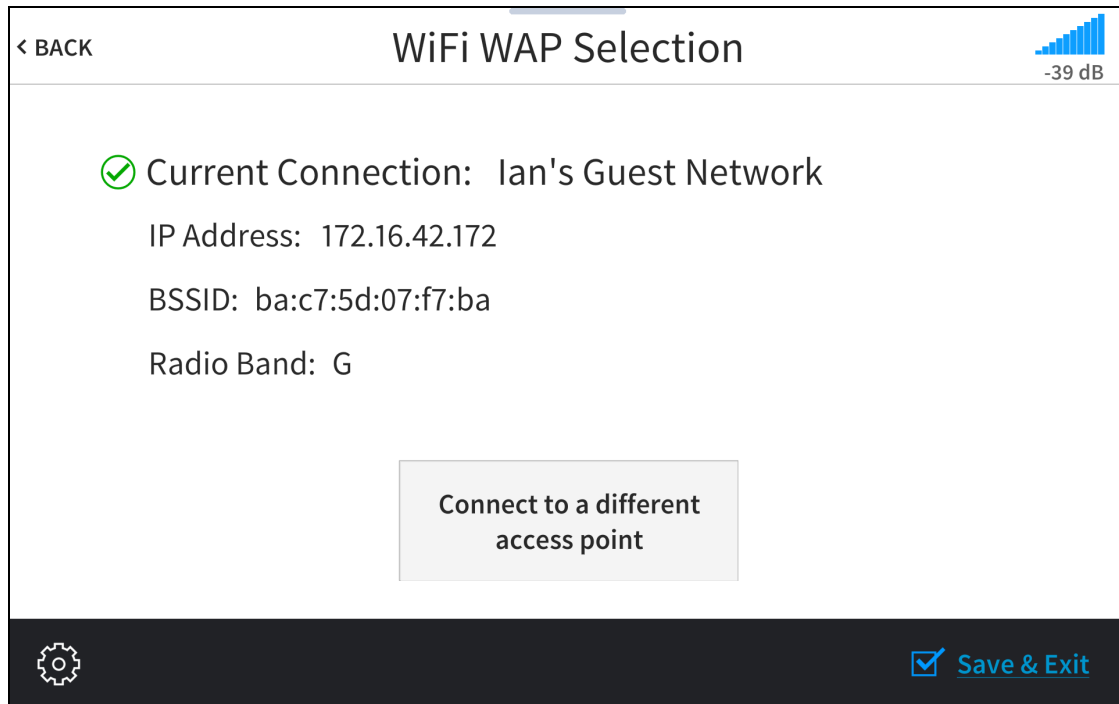

If the connection fails, a failure message is displayed. Tap **Connect to a different access point** to return to the **Connect to a Wi-Fi Access Point (1-2-3)** screen.

NOTE: If four WAPs have already been assigned, the **Wi-Fi WAP Selection** screen indicates that the WAP list is full. Tap **Delete an access point?** to display the **Manage Wi-Fi Access Points** screen, where an existing WAP may be deleted, or tap **< BACK** to cancel adding the new WAP. For more information, refer to [Manage Wi-Fi Access Points on page 87](#).

Tap **< BACK** to return to the **Wi-Fi Setup** screen.

Manage Wi-Fi Access Points

On the **Wi-Fi Setup** screen, tap **Manage Wi-Fi Access Points**. The **Manage Wi-Fi Access Points** screen is displayed.

Manage Wi-Fi Access Points Screen

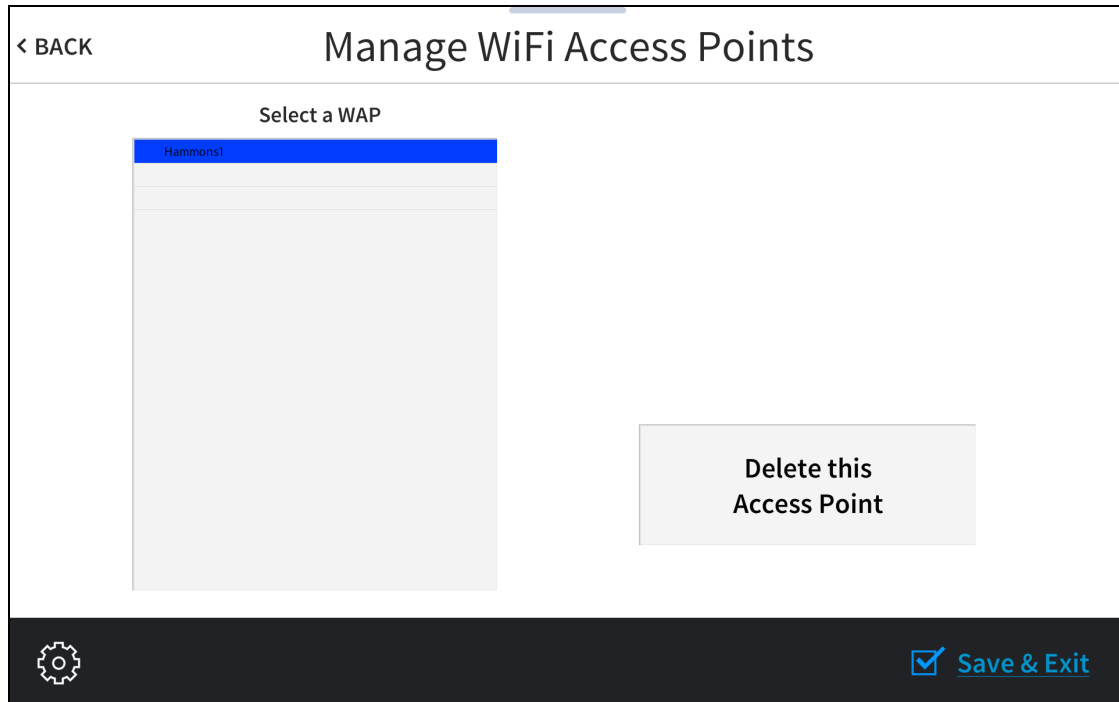

Use the **Manage Wi-Fi Access Points** screen to manage settings for up to four saved WAPs. Tap one of the listed WAPs to display controls to manage the WAP.

Tap **Delete this Access Point** to delete the selected WAP. If a WAP is deleted, it must be added back to the list using the procedures described in [Select a Wi-Fi Access Point on page 84](#).

Tap **< BACK** to return to the **Wi-Fi Setup** screen.

Bluetooth Beacon

Tap **BLE Beacon** on the Setup screen to display the **BLE Beacon** screen.

BLE Beacon Screen



Use the **BLE Beacon** screen to configure the built-in PinPoint™ proximity detection beacon. Using Bluetooth® technology, the beacon works with the Crestron App or Crestron PinPoint App to determine when a mobile device is in or near the same room as the beacon, and signals the mobile app to automatically display the appropriate controls and information for the room.

- Tap **On** or **Off** underneath **BLE Beacon** to turn the proximity beacon on or off, respectively.
- Tap **On** or **Off** underneath **Config Mode** to turn configuration mode on or off, respectively. Turning on configuration mode enables the proximity beacon to be configured.

NOTE: The proximity beacon and configuration mode cannot both be turned on at the same time.

Tap < **BACK** to return to the Setup screen.

Virtual Toolbar

Tap **Virtual Toolbar** on the Setup screen to display the **On-screen Toolbar** screen.

On-screen Toolbar Screen

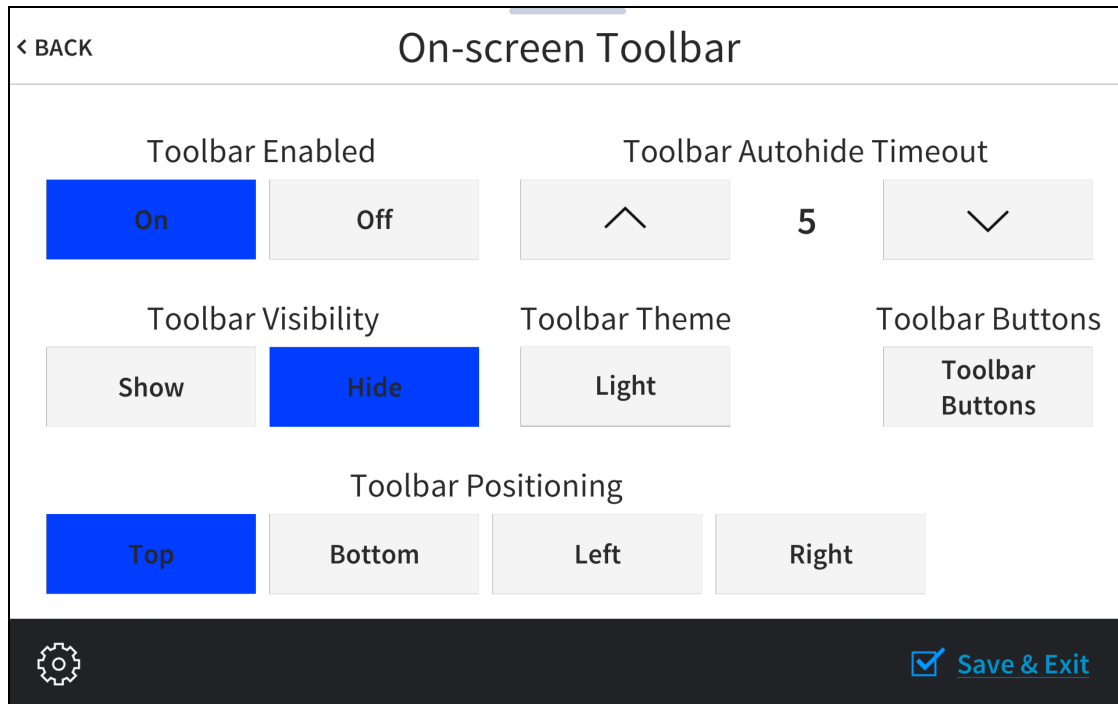

Use the **On-screen Toolbar** screen to configure settings for the virtual toolbar. By default, the virtual toolbar can be accessed by swiping down on the tab located at the top of the screen and provides virtual buttons for power, home, lighting, up, down, and microphone. The toolbar is hidden automatically after a set timeout duration.

NOTE: Virtual button functionality can be custom programmed using a Crestron control system.

On-screen Toolbar Screen (with Virtual Toolbar)

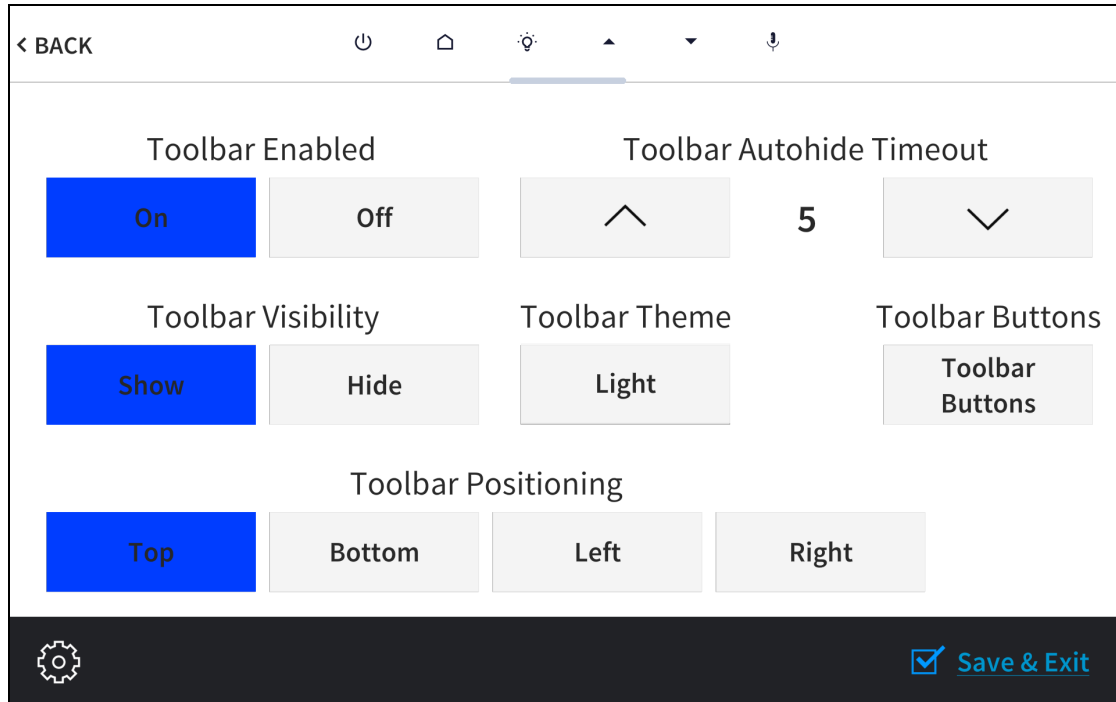

- Tap **On** or **Off** under **Toolbar Enabled** to turn the virtual toolbar on or off, respectively.
- Tap **Show** or **Hide** under **Toolbar Visibility** to have the toolbar exposed or hidden by default, respectively.
- Tap **Top**, **Bottom**, **Left**, or **Right** under **Toolbar Positioning** to place the toolbar on the respective location on the screen.
- Tap the up and down arrow buttons under **Toolbar Autohide Timeout** to increase or decrease the duration before the toolbar is automatically hidden from 0 to 600 seconds. Selecting "0" disables this behavior.
- Tap the button under **Toolbar Theme** to switch between a light and dark theme. The currently selected theme is displayed on the button.
- Tap **Toolbar Buttons** to display a screen for showing or hiding individual buttons in the virtual toolbar. Tap **On** or **Off** next to a button to show or hide the button, respectively.

On-screen Toolbar Screen - Toolbar Buttons

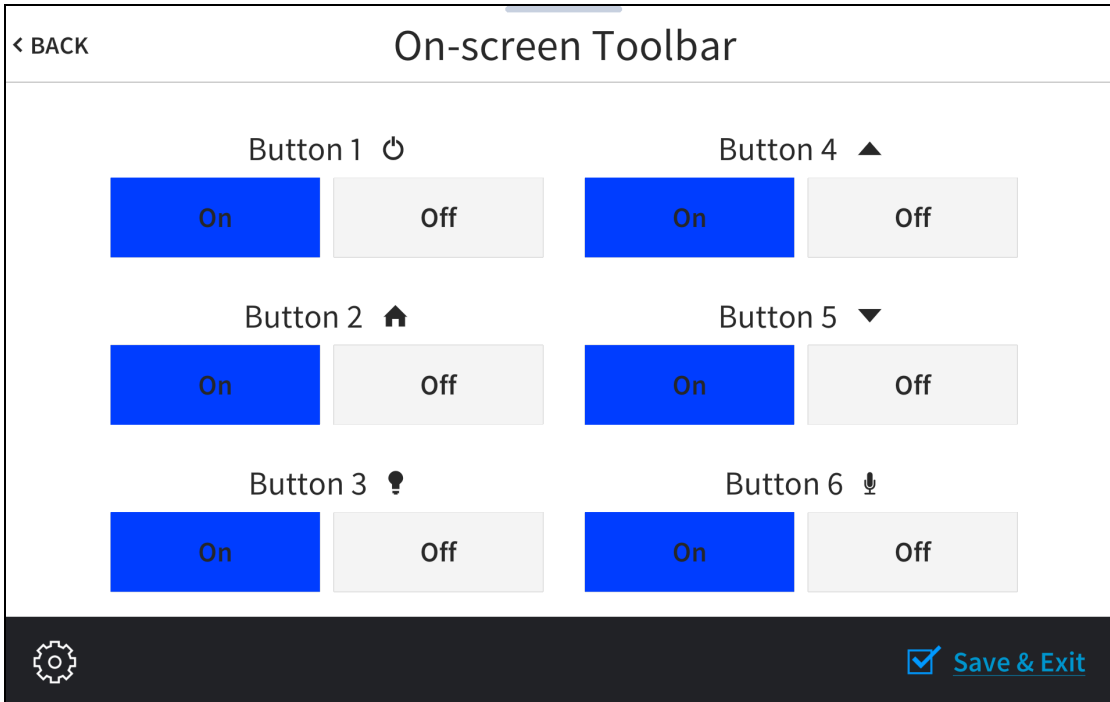

Tap < **BACK** to return to the Setup screen.

Diagnostics & Advanced

Tap **Diagnostics** on the Setup screen to display the **Diagnostics & Advanced** screen.

Diagnostics & Advanced Screen

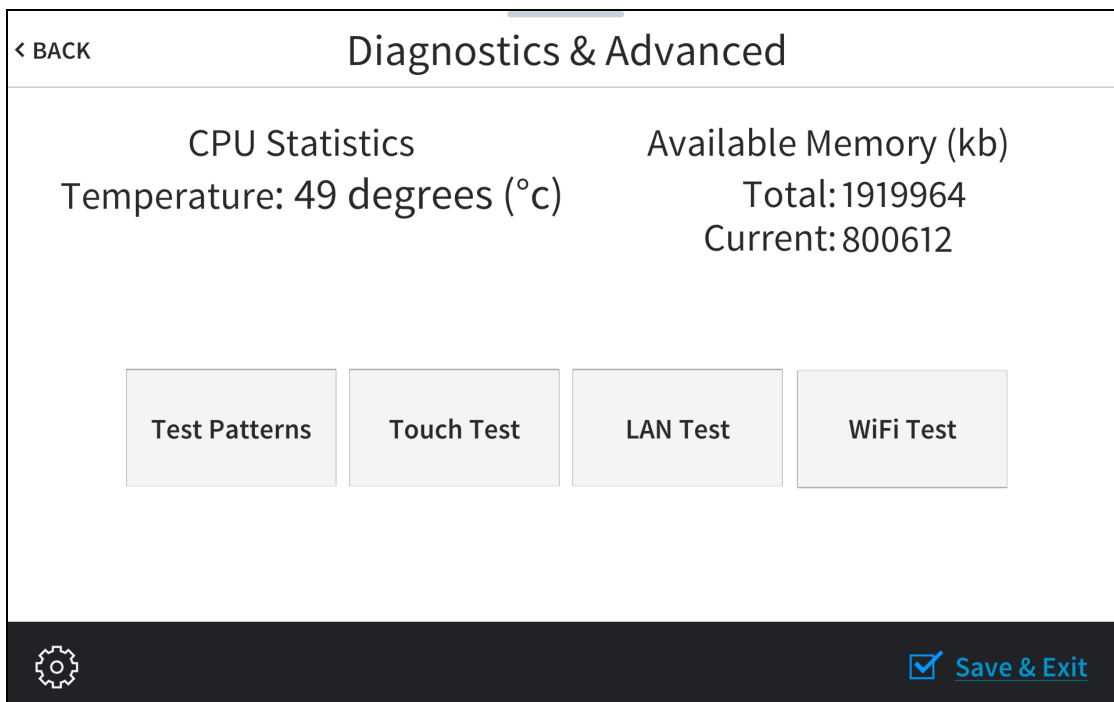

Use the **Diagnostics & Advanced** screen to access various diagnostic test screens for the touch screen. The **Diagnostics & Advanced** screen also provides the touch screen CPU temperature and available memory.

Each test screen is described in the sections that follow.

Test Patterns

Tap **Test Patterns** on the **Diagnostics & Advanced** screen to display the **Test Pattern Diagnostics** screen.

Test Pattern Diagnostics Screen

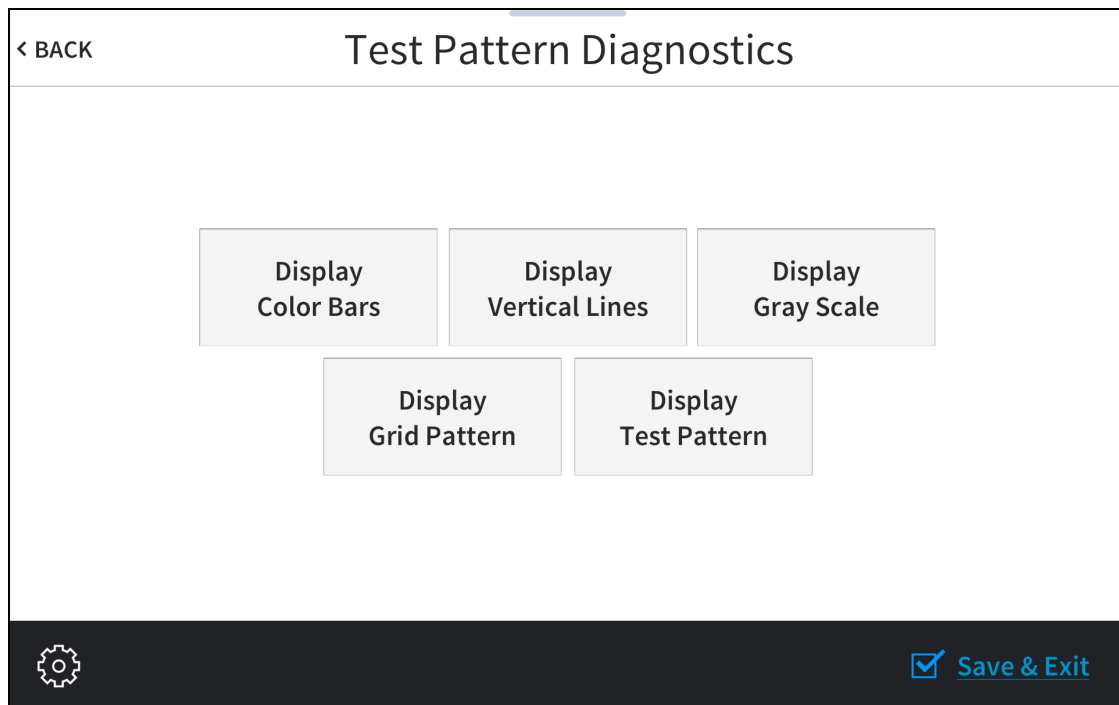

Use the **Test Pattern Diagnostics** screen to display any of the available test patterns. Tap one of the buttons on the screen to display its respective test pattern.

Tap **< BACK** to return to the **Diagnostics & Advanced** screen.

Touch Test

Tap **Touch Test** on the **Diagnostics & Advanced** screen to display the touch test screen.

Touch Test Screen

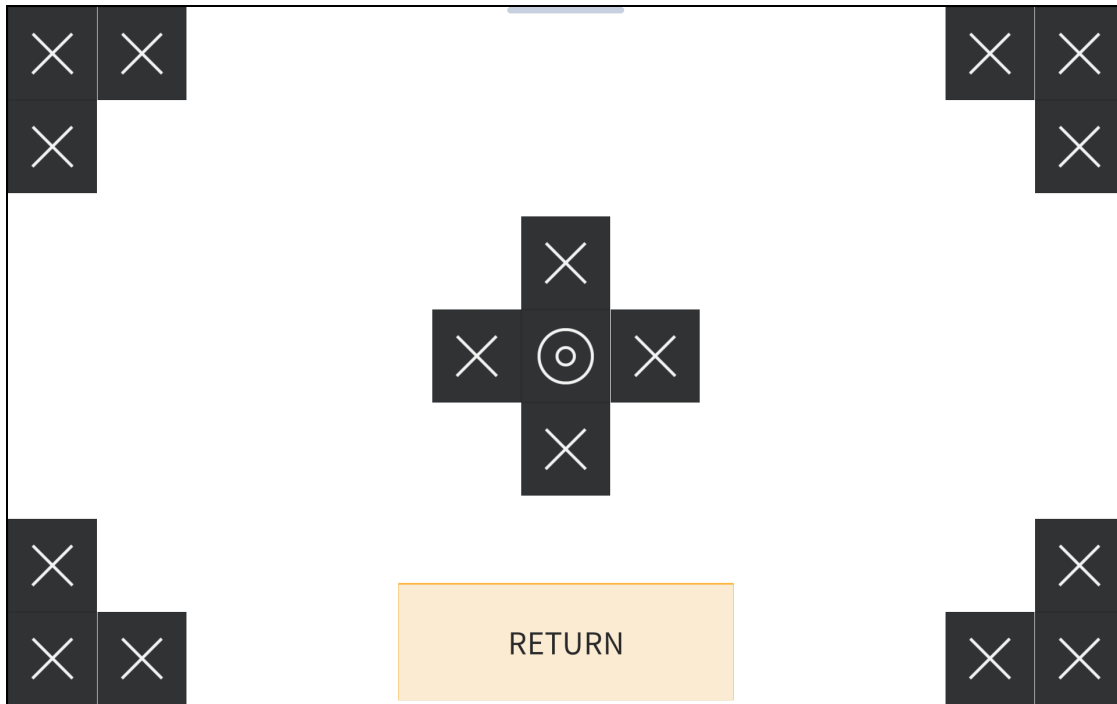

Use the touch test screen to test the touch functionality of the display. When a location button is tapped, its respective indicator lights on the screen.

Tap **RETURN** to return to the **Diagnostics & Advanced** screen.

LAN Test

Tap **LAN Test** on the **Diagnostics & Advanced** screen to display the **Ethernet Diagnostics** screen.

Ethernet Diagnostics Screen

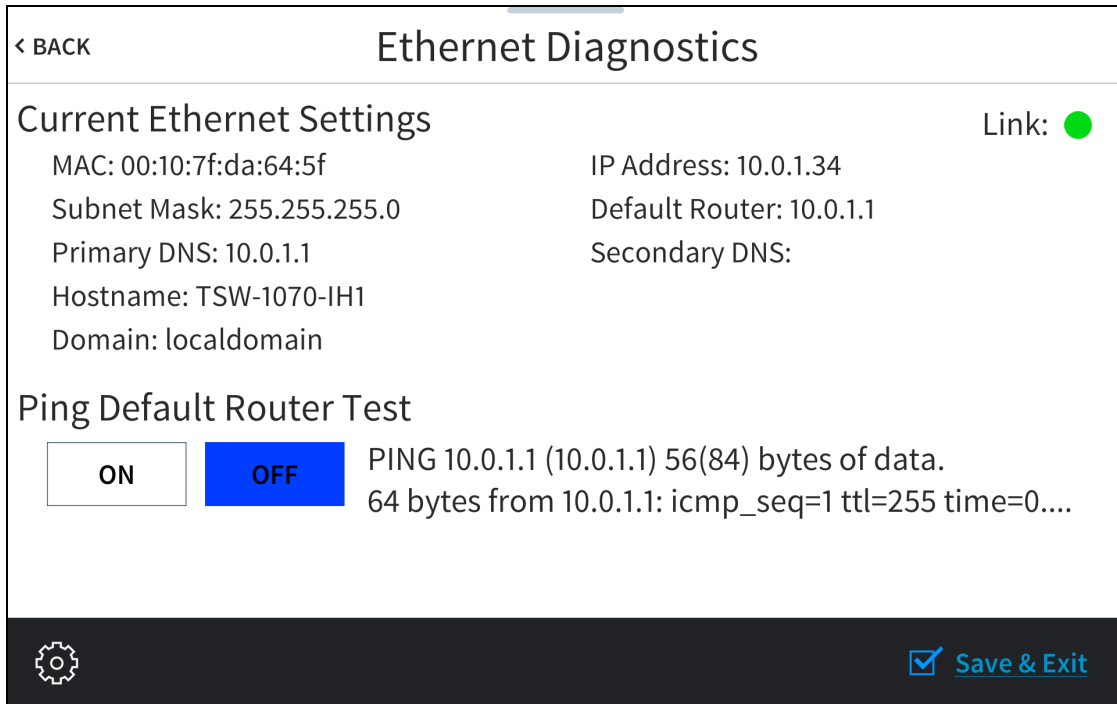

Use the **Ethernet Diagnostics** screen to view and test the Ethernet connection. The Ethernet Diagnostics screen displays the touch screen MAC and IP addresses, subnet mask address, default router address, primary and secondary DNS addresses, host name, and domain name. A **Link** indicator is provided to indicate the status of the Ethernet connection. (Green indicates that the Ethernet connection is active.)

The **Ethernet Diagnostics** screen also provides controls to test the connection to the default router. Tap **On** to begin the test and **Off** to end the test.

During the router test, the touch screen pings the default router. If the router is communicating with the touch screen, connection data is displayed below the ping test controls within five seconds. The connection data updates after every successive ping.

Tap **< BACK** to return to the **Diagnostics & Advanced** screen.

Wi-Fi Test

Tap **Wi-FiTest** on the **Diagnostics & Advanced** screen to display the **Wi-Fi Diagnostics** screen.

Wi-Fi Diagnostics Screen

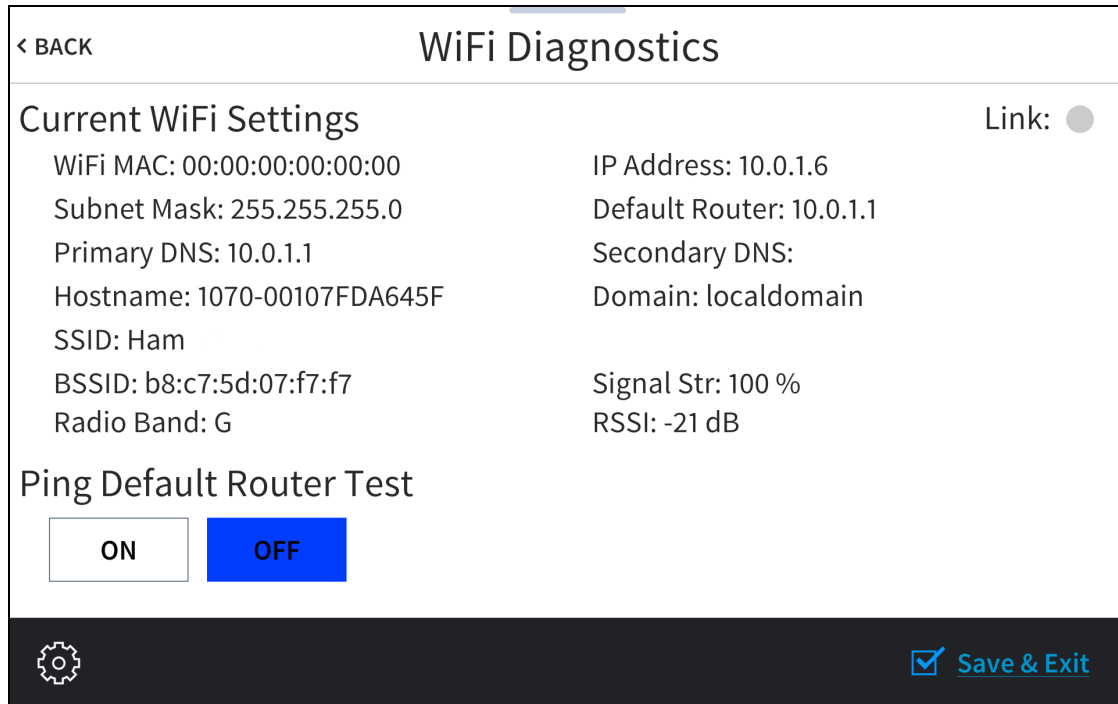

Use the **Wi-Fi Diagnostics** screen to view and test the Wi-Fi network connection. The **Wi-Fi Diagnostics** screen displays the Wi-Fi network MAC and IP addresses, subnet mask address, default router address, primary and secondary DNS addresses, host name, and domain name. A **Link** indicator is provided to indicate the status of the Wi-Fi network connection. (Green indicates that the Wi-Fi network connection is active.)

The **Wi-Fi Diagnostics** screen also provides controls to test the connection to the default router. Tap **On** to begin the test and **Off** to end the test.

During the router test, the touch screen pings the default router. If the router is communicating with the touch screen, connection data is displayed below the ping test controls within five seconds. The connection data updates after every successive ping.

Tap **< BACK** to return to the **Diagnostics & Advanced** screen.

About

Tap **About** on the Setup screen to display the **About** screen.

About Screen

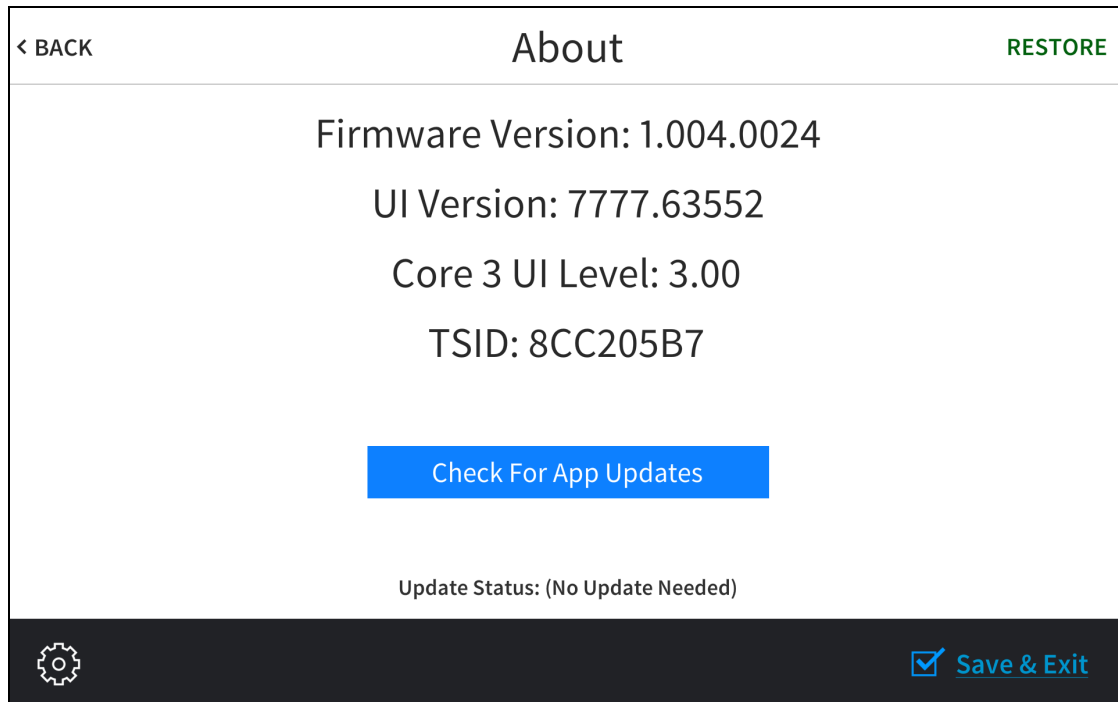

Use the **About** screen to view information about the touch screen, including the firmware version and the operating system versions.

Tap **Check For App Updates** to scan the network for any updates to the touch screen applications. If application updates are available, the touch screen downloads and installs the updates. The status of the updates is shown on the bottom of the screen.

NOTE: The **Check For App Updates** button is shown only if an application is running on the touch screen.

Tap **RESTORE** at the top right of the screen to restore the touch screen to its default factory settings.

Tap **< BACK** to return to the Setup screen.

Web Configuration

The touch screen may be monitored and configured using the included web configuration interface. The configuration interface is accessible from a web browser if the touch screen IP address is known.

The web configuration interface is also accessible through the XiO Cloud® service. For more information, refer to [Installation on page 57](#).

To access the configuration interface:

1. Use the Device Discovery tool in Crestron Toolbox™ software to discover the touch screen and its IP address on the network.
2. Open a web browser.
3. Enter the touch screen IP address into the browser URL field. The configuration interface is displayed (TSS-770 shown).

NOTE: If authentication is turned on for the touch screen, an administrator username and password must be entered prior to accessing the web configuration interface. For more information on configuring authentication settings, refer to [Web Configuration on page 97](#).

Web Configuration Interface

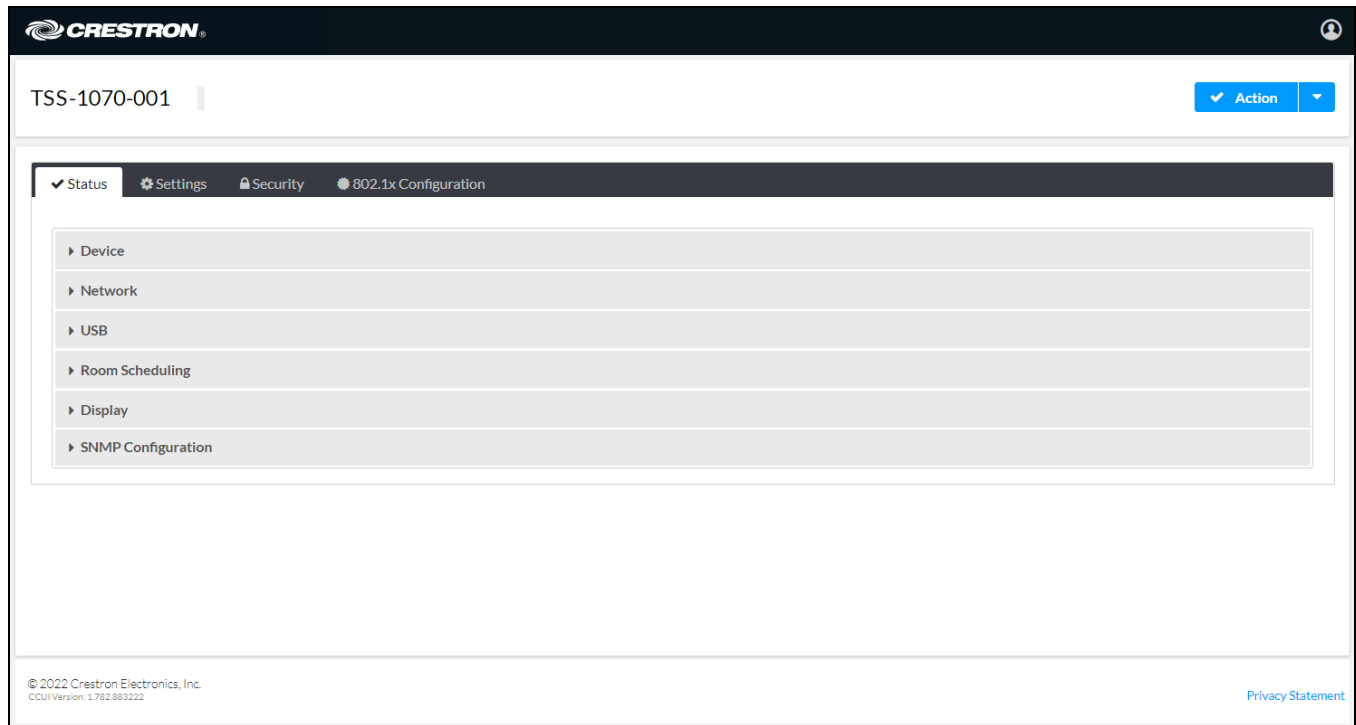

The configuration interface provides the following tabs:

- **Status:** Used to monitor touch screen status
- **Settings:** Used to configure touch screen settings

- **Security:** Used to enable authentication and other security settings
- **802.1x Configuration:** Used to configure IEEE 802.1X network authentication for touch screen security

NOTE: Some device settings may be displayed or hidden depending on the selected application mode.

If the Crestron room scheduling application is running on the touch screen, the web configuration utility provides additional configuration options for the room scheduling application. For more information, refer to the [Crestron Room Scheduling Panels Operations Guide](#).

The **Status** tab is the default tab that is displayed, as shown in the previous image.

Actions Menu

The configuration interface provides an **Actions** drop-down menu on the top right of the page. The **Actions** menu may be accessed at any time.

Actions Menu

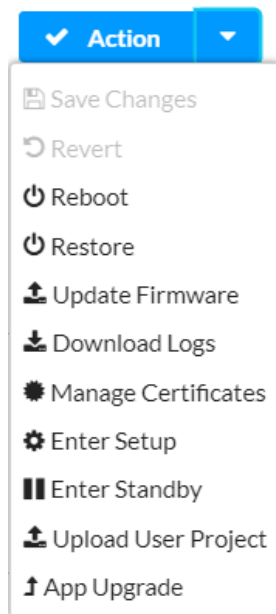

Once any changes have been made to the touch screen configuration, the **Actions** button changes to a **Save Changes** button. Select **Save Changes** to save changes to the configuration settings.

If a restart is required after changes have been saved, a dialog box is displayed asking whether the restart should be performed. Select **Yes** to restart the device or **No** to cancel the restart.

The **Actions** menu provides the following selections.

Save Changes

Select **Save Changes** to save any changes made to the configuration settings.

Revert

Select **Revert** to revert the touch screen back to the last saved configuration settings.

Reboot

Select **Reboot** to restart the touch screen.

After **Reboot** is selected, a dialog box is displayed asking whether the touch screen should be restarted. Select **Yes** to restart the device or **No** to cancel the restart.

Restore

Select **Restore** to restore the touch screen configuration settings to their default values.

After **Restore** is selected a dialog box is displayed asking whether the device settings should be restored. Select **Yes** to restore the settings or **No** to cancel the restore.

Update Firmware

Select **Update Firmware** to upgrade the touch screen firmware manually with a downloaded PUF (package update file). The **Firmware Upgrade** dialog box opens.

Firmware Upgrade Dialog Box

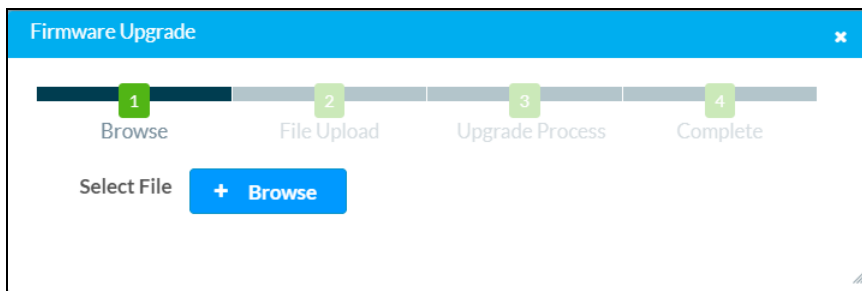

To upload a firmware PUF through the web configuration interface:

NOTE: Visit the appropriate device product page or www.crestron.com/Support/Resource-Library to download the latest firmware PUF.

1. Select **Browse**, and then navigate to the firmware PUF on the host computer.
2. Select the firmware PUF, and then select **Open**.
3. Select **Load** to load the PUF to the touch screen. The upload progress is shown in the dialog box.
4. Once the touch screen has completed the firmware upgrade, select **OK**.

Select the **x** button to close the **Firmware Upgrade** dialog box at any time during the upgrade process. Selecting the **x** button before the PUF is uploaded to the touch screen cancels the upgrade.

Download Logs

Select **Download Logs** to download the touch screen message logs for diagnostic purposes. The message files download as a compressed .tgz file. Once the compressed file is downloaded, extract the message log files to view them.

Manage Certificates

Select **Manage Certificates** to manage any certificates that are installed on the touch screen. For more information on certificate management, refer to [802.1x Configuration on page 131](#).

Enter Setup

Select **Enter Setup** to force the touch screen to enter its built-in setup interface.

Enter Standby

Select **Enter Standby** to force the touch screen to enter standby mode.

Upload Scheduling Project

Select **Upload Scheduling Project** to upload a custom scheduling project to the touch screen. A **Project Upload** dialog box opens.

Project Upload Dialog Box

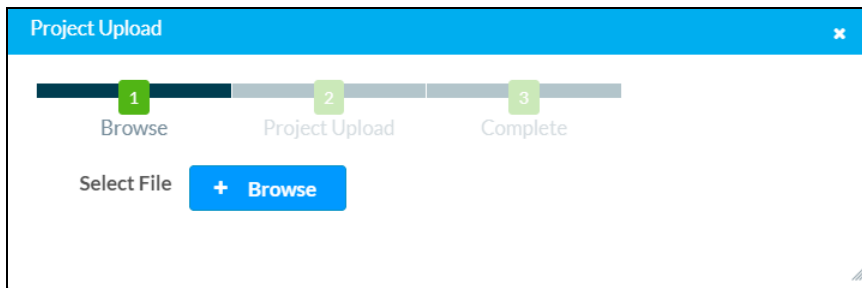

NOTE: This selection is available only if the touch screen is running in **Crestron Default** scheduling mode.

To upload a custom scheduling project:

1. Select **Browse**, and then navigate to the project .vtz file on the host computer.
2. Select the project .vtz file, and then select **Open**.
3. Select **Load** to load the project .vtz file to the touch screen. The upload progress is shown in the dialog box.
4. Once the touch screen has completed the project upload, select **OK**.

Select the **x** button to close the **Project Upload** dialog box at any time during the upgrade process. Selecting the **x** button before the project file is uploaded to the touch screen cancels the upload.

App Upgrade

Select **App Upgrade** to update the currently selected application. The update progress is shown in a pop-up window.

Once the update is complete, select **OK** to close the pop-up window.

Status

Select the **Status** tab on the top left of the configuration interface to display selections for viewing the status of device, network, and control system settings.

Select on a selection name to expand the selection. If the selection is expanded, select the selection name again to collapse the section.

Status Tab Selections



Each selection is described in the sections that follow.

Device

Select **Device** to view general device information.

Status Tab - Device

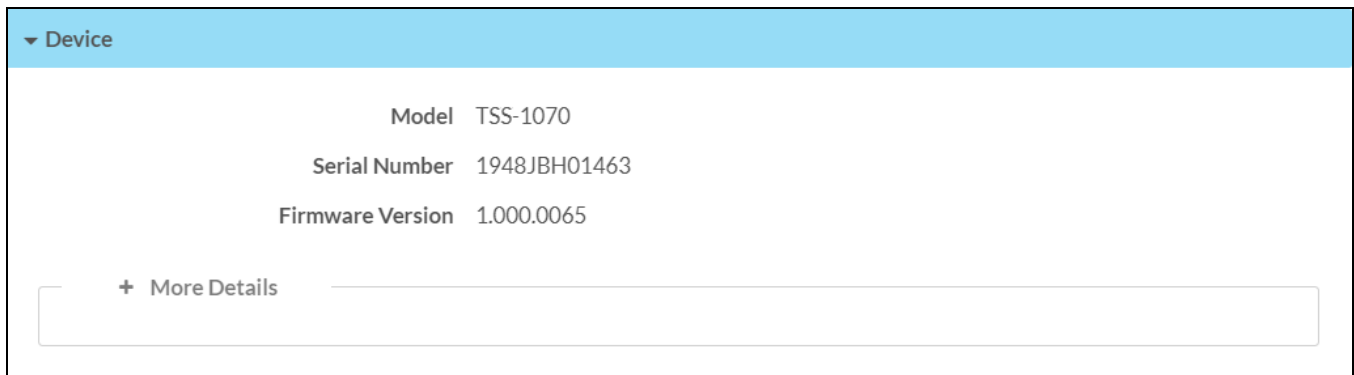

The following **Device** information is displayed:

- **Model:** The touch screen model name
- **Serial Number:** The touch screen serial number
- **Firmware Version:** The firmware version loaded onto the touch screen

Select **+ More details** at the bottom of the **Device** tab to display an expanded section that shows additional touch screen information. If **+ More Details** is selected, select **- Less** details to collapse the section.

Network

Select **Network** to view the status of the network settings for the touch screen.

Status Tab - Network

The screenshot displays the Network settings status tab. It is organized into several sections:

- IPv6:** Hostname TSS-1070-001, IPv6 Enabled Yes, DNS Servers (empty).
- IPv4:** DNS Servers 10.0.1.1(DHCP).
- Primary LAN:**
 - IPv4: Domain localdomain, DHCP Enabled On, IP Address 10.0.1.0, Subnet Mask 255.255.255.0, Default Gateway 10.0.1.1, Link Active True, MAC Address 00.10.7f.da.64.00.
 - IPv6: Default Gateway ::.
 - A table showing Subnet Prefix Length 64, IP Address fe80::6a8c:d44:f5ad:fe80, and Type Link Local.
- WIFI:** IPv4: Domain localdomain, Link Active False, MAC Address de.ad.be.ef.12.de.
- LAN:** Network Proxy Settings Disabled.

The following **Network** information is displayed:

- **Host Name:** The touch screen host name
- **IPv6 Enabled:** Reports whether IPv6 addressing is turned on (**Yes**) or not (**No**)
- **DNS Servers (IPv6):** The DNS (domain name server) addresses used to resolve the touch screen domain to an IPv6 address

- **DNS Servers (IPv4):** The DNS (domain name server) addresses used to resolve the touch screen domain to an IPv4 address

Select the + (plus) icon next to **Primary LAN** to display the following Ethernet settings:

- **Domain:** The touch screen domain name
- **IPv4:** Contains settings for IPv4 Ethernet addressing
 - **DHCP Enabled:** Reports whether the IPv4 Ethernet address is static (**Yes**) or dynamic (**No**)
 - **IP Address:** The touch screen IPv4 Ethernet address, shown only if an Ethernet connection is active
 - **Subnet Mask:** The touch screen subnet mask address, shown only if an Ethernet connection is active
 - **Default Gateway:** The gateway router address, shown only if an Ethernet connection is active
 - **Link Active:** Reports the status of the Ethernet connection (A **true** message indicates that the Ethernet connection is active, while a **false** message indicates that the Ethernet connection is inactive.)
 - **MAC Address:** The unique MAC (media access control) address for the Ethernet adapter
- **IPv6:** Contains settings for IPv6 Ethernet addressing
 - **Default Gateway:** The gateway router address, shown only if an Ethernet connection is active and IPv6 addressing is active
 - Each IPv6 Ethernet address configured for the touch screen is displayed in a table with the following information:
 - **Subnet Prefix Length:** The subnet prefix length for the IPv6 Ethernet address
 - **IP Address:** The IPv6 Ethernet address
 - **Type:** The IPv6 Ethernet address type

Select the + (plus) icon next to **Wi-Fi** to display the following Wi-Fi network settings:

- **Domain:** The Wi-Fi network domain name
- **DHCP Enabled:** Reports whether the Wi-Fi network IP address is static (**Yes**) or dynamic (**No**), shown only if a Wi-Fi network connection is active
- **IP Address:** The Wi-Fi network IP address, shown only if a Wi-Fi network connection is active
- **Subnet Mask:** The Wi-Fi network subnet mask address, shown only if a Wi-Fi network connection is active
- **Default Gateway:** The Wi-Fi network gateway router address, shown only if a Wi-Fi network connection is active
- **Link Active:** Reports the status of the Wi-Fi network connection (A true message indicates that the Wi-Fi network connection is active, while a false message indicates that the Wi-Fi network connection is inactive.)
- **MAC Address:** The unique Wi-Fi network MAC (media access control) address

Select the + (plus) icon next to **LAN** to display the following LAN settings:

- **Network Proxy Settings:** Reports whether network proxy settings are turned on or off for the touch screen

For more information on configuring network settings, refer to [System Setup on page 106](#).

USB

Select **USB** to view the status of a connected USB accessory, such as a room scheduling hallway sign or light bar.

Status Tab - USB

▼ USB
Accessory Connected No
Accessory Type

The following **USB** information is displayed:

- **Accessory Connected:** The name of the connected accessory
- **Accessory Type:** The type of connected accessory

Room Scheduling

Select **Room Scheduling** to view the status of the room if using a room scheduling application.

Status Tab - Room Scheduling

▼ Room Scheduling
Room Status Offline
Calendar Sync
Fusion Online Status Offline

The following **Room Scheduling** information is displayed:

- **Room Status:** The status of the connected room (available or reserved)
- **Calendar Sync:** The status of the sync between the touch screen and the room scheduling calendar
- **Crestron Fusion Online Status:** The status of the Crestron Fusion connection (if applicable)

Display

Select **Display** to view the display status.

Status Tab - Display

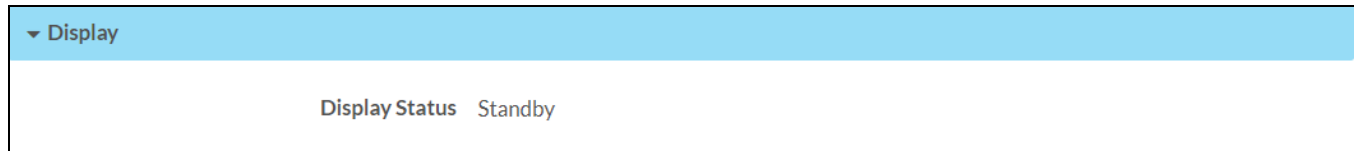

The **Display Status** field indicates the display status (on, standby, or screensaver).

SNMP Configuration

Select **SNMP Configuration** to view the status of the SNMP (Simple Network Management Protocol) configuration for the touch screen.

Status Tab - SNMP Configuration

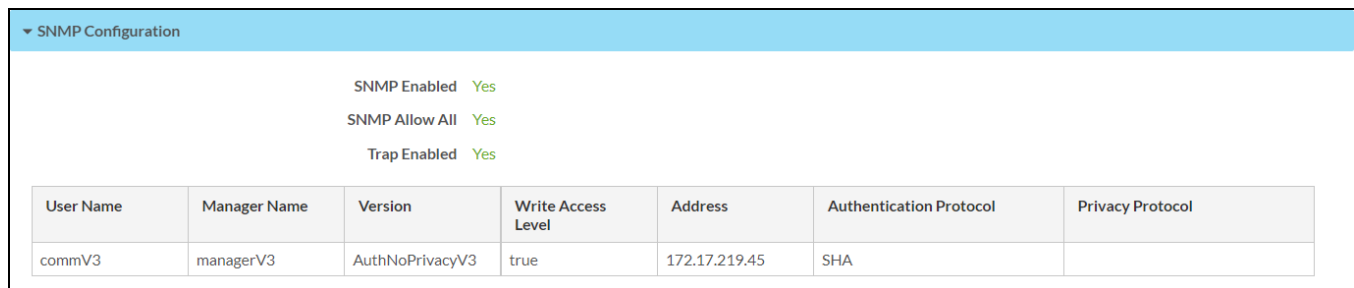

The following **SNMP Configuration** information is displayed:

- **SNMP Enabled:** Reports whether SNMP has been turned on for the touch screen (**Yes**) or not (**No**)
- **SNMP Allow All:** Reports whether the touch screen allows SNMP requests from all managers (**Yes**) or not (**No**)
- **Trap Enabled:** Reports whether SNMP trap notifications have been turned on (**Yes**) or not (**No**)
- Each SNMP user configured for the touch screen is displayed in a table with the following information:
 - **User Name:** The name of the SNMP user
 - **Manager Name:** The SNMP manager for the user
 - **Version:** The SNMP version set for the user
 - **Write Access Level:** Indicates whether the user has write level permissions (**true**) or read-only permissions (**false**)
 - **Address:** The IP address of the SNMP manager
 - **Authentication Protocol:** The authentication protocol used by the SNMP manager
 - **Privacy Protocol:** The privacy protocol used by the SNMP manager

Settings

Select the **Settings** tab on the top left of the configuration interface to display selections for configuring various touch screen settings and to select a touch screen application.

Settings Selections



Each selection is described in the sections that follow.

NOTE: If an invalid value is entered for a setting, the web interface will not allow changes to be saved until a valid value is entered. Red text is displayed next a setting to indicate an invalid value.

System Setup

Select **System Settings** to configure general network and touch screen settings.

Settings Tab - System Setup



Date/Time

Select the + (plus) icon next to **Date/Time** to display the following time and date settings.

Settings Tab - System Setup (Date/Time)

- Date/Time

Synchronization

Time Synchronization

NTP Time Servers

<input type="checkbox"/>	Address	Port	Authentication Method	Authentication Key	Key ID
<input type="checkbox"/>	pool.ntp.org	123	None	0

Configuration

Time Zone: (UTC - 05: 00) Eastern Time (US & ...)

Date: 04/30/2021

Time Format: 12 24

Date Format: WMDY

Time: 15:30

Time Synchronization

- **Time Synchronization:** Turn on the toggle to use time synchronization via SNTP (Simple Network Time Protocol).
- **Synchronize Now:** With **Time Synchronization** turned on, select **Synchronize Now** to synchronize the touch screen with the SNTP server(s) entered in the **NTP Time Servers** table.

- **NTP Time Servers:** With **Time Synchronization** turned on, use the provided table to enter information regarding the SNTP server(s) used to synchronize the date and time for the touch screen.
 - Select **Add** to add a new SNTP server entry into the table.
 - Enter the following information for each entry:
 - Enter the SNTP server address into the **Address** text field.
 - Enter the SNTP server port into the **Port** text field.
 - Use the **Authentication Method** drop-down menu to select the authentication method used to access the SNTP server (if one exists).
 - If an authentication method is selected, enter the key used to authenticate against the SNTP server into the **Authentication Key** text field.
 - If an authentication method is selected, enter the ID for the key used to authenticate against the SNTP server into the **Key ID** text field.
 - To remove an entry, fill the checkbox to the left of the table entry, and then select **Delete**.

Time Configuration

- **Time Zone:** Select a time zone for the touch screen using the drop-down menu.
- **Date:** Select the date for the touch screen using the pop-up calendar that is displayed.
- **Time Format:** Select the format that the time will display on the touch screen (12 hour or 24 hour).
- **Date Format:** Select the format that the date will display on the touch screen using the drop-down menu.
- **Time:** Select the time for the touch screen (in 24-hour format) using the pop-up menu that is displayed.

Device Display

Select the + (plus) icon next to **Device Display** to display the following device display settings.

Settings Tab - System Setup (Device Display)

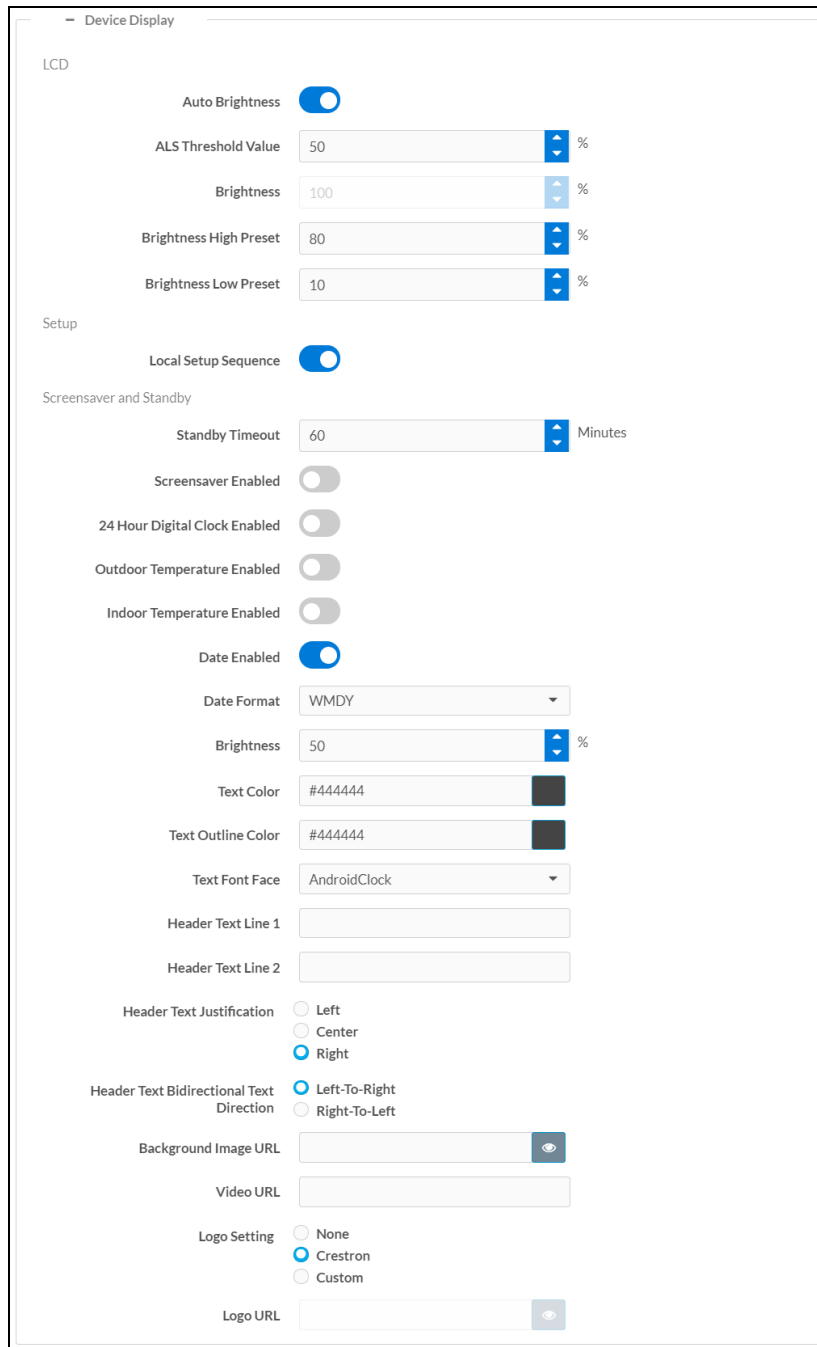

Device Display

LCD

Auto Brightness

ALS Threshold Value 50 %

Brightness 100 %

Brightness High Preset 80 %

Brightness Low Preset 10 %

Setup

Local Setup Sequence

Screensaver and Standby

Standby Timeout 60 Minutes

Screensaver Enabled

24 Hour Digital Clock Enabled

Outdoor Temperature Enabled

Indoor Temperature Enabled

Date Enabled

Date Format WMDY

Brightness 50 %

Text Color #444444

Text Outline Color #444444

Text Font Face AndroidClock

Header Text Line 1

Header Text Line 2

Header Text Justification Left Center Right

Header Text Bidirectional Text Direction Left-To-Right Right-To-Left

Background Image URL

Video URL

Logo Setting None Crestron Custom

Logo URL

- LCD
 - **Auto Brightness:** Turn on the toggle to use automatic brightness control for the touch screen LCD display.

- **ALS Threshold Value:** If **Auto Brightness** is turned on, enter a value (1–100%) for the ALS (ambient light sensor) threshold, which is used for switching between high and low autobrightness presets.
- **Brightness:** If **Auto Brightness** is turned off, enter a value (1–100%) for the LCD display brightness.
- **Brightness High Preset:** Enter a value (1–100%) for the LCD display high brightness preset.
- **Brightness Low Preset:** Enter a value (1–100%) for the LCD display low brightness preset.
- **Setup**
 - **Local Setup Sequence:** Turn on the toggle to allow local access to the setup screens using a five-finger press.
- **Screensaver and Standby**
 - **Standby Timeout:** Enter a standby timeout duration (1–120 minutes) for the touch screen.
 - **Screensaver Enabled:** Turn on the toggle to show a screensaver on the touch screen during standby timeout.
 - **24 Hour Digital Clock Enabled:** Turn on the toggle to display a 24-hour digital clock on the touch screen during standby timeout.
 - **Outdoor Temperature Enabled:** Turn on the toggle to display the outdoor temperature on the touch screen during standby timeout via a join from a control system.
 - **Indoor Temperature Enabled:** Turn on the toggle to display the indoor temperature on the touch screen during standby timeout via a join from a control system.
 - **Date Enabled:** Turn on the toggle to display the date on the touch screen during standby timeout.
 - **Date Format:** Use the drop-down menu to select a format for displaying the date on the touch screen.
 - **Brightness:** Enter a brightness value (1–100%) for the screensaver.
 - **Text Color:** Select the color icon to the right of this field to display a pop-up window for selecting the text color of the screensaver, or enter a hex value for a specific color.
 - **Text Outline Color:** Select the color icon to the right of this field to display a pop-up window for selecting the text outline color of the screensaver, or enter a hex value for a specific color.
 - **Text Font Face:** Use the drop-down menu to select a font for the screensaver text.
 - **Header Text Line 1:** Enter text to be displayed on the first header text line of touch screen screensaver.
 - **Header Text Line 2:** Enter text to be displayed on the second header text line of touch screen screensaver.
 - **Header Text Justification:** Select one of the radio buttons (**Left**, **Center**, or **Right**) to select how the header text is justified on the touch screen screensaver.
 - **Header Text Bidirectional Text Direction:** Select one of the radio buttons (**Left-To-Right** or **Right-To-Left**) to determine the language text direction on the touch screen screensaver.
 - **Background Image URL:** Enter a URL of a background image to be used by the touch screen screensaver.

- **Video URL:** Enter a URL of video to be used by the touch screen screensaver.
- **Logo Setting:** Select one of the radio buttons (**None**, **Crestron**, and **Custom**) to select a logo type to use on the touch screen screensaver.
- **Logo URL:** If **Logo Setting** is set to **Custom**, enter a URL of a custom logo to be used by the touch screen screensaver.

Proximity

Select the + (plus) icon next to **Proximity** to display the following proximity settings.

Settings Tab - System Setup (Proximity)



Turn on the **Wake On Proximity** toggle wake the touch screen automatically when a user enters the touch screen proximity field.

Button Toolbar

Select the + (plus) icon next to **Button Toolbar** to display the following virtual toolbar button settings.

Settings Tab - System Setup (Button Toolbar)

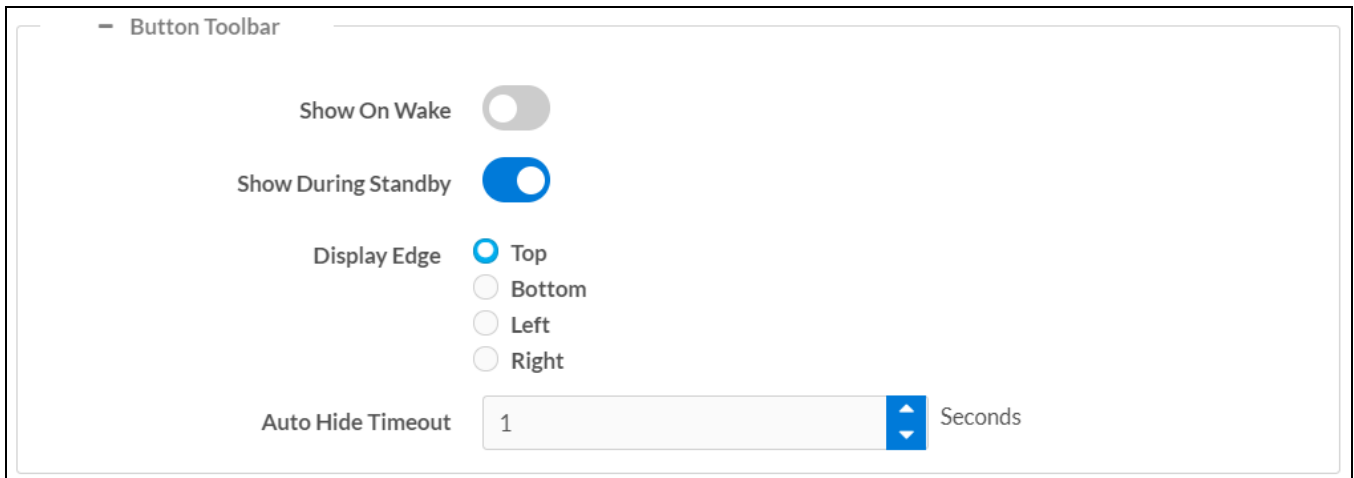

- **Show On Wake:** Turn on the toggle to show the virtual toolbar when the touch screen wakes from standby timeout.
- **Show During Standby:** Turn on the toggle to show the virtual toolbar during standby timeout.
- **Display Edge:** Select a radio button (**Top**, **Bottom**, **Left**, or **Right**) to select the position on the touch screen where the virtual toolbar is displayed.
- **Auto Hide Timeout:** Select a duration (in seconds) that must elapse before the virtual toolbar is hidden automatically.

Pinpoint Beacon

Select the + (plus) icon next to **PinPoint Beacon** to display the following Bluetooth beacon settings.

Settings Tab - System Setup (PinPoint Beacon)



- **BT Enabled:** Turn on the toggle to use the Bluetooth beacon.
- **BT Mode:** Use the drop-down menu to select the mode (**Advertise** or **Config**) of the Bluetooth beacon.
 - Select **Advertise** to make the Bluetooth beacon available to Crestron devices that support this functionality.
 - Select **Config** to put the Bluetooth beacon into configuration mode.

Network

Select **Network** to configure network settings for the touch screen.

Settings Tab - System Setup (Network)

The screenshot displays the Network settings interface, organized into three main sections: IPv6, Primary LAN, and WIFI.

- IPv6 Section:** Includes fields for Hostname (TSW-1070-001), IPv6 Enabled (toggle on), Primary Static DNS, and Secondary Static DNS.
- Primary LAN Section:** Includes Adapter Enabled (toggle on), Domain (localdomain), DHCP (toggle on), IP Address (10.0.1.0), Subnet Mask (255.255.255.0), and Default Gateway (10.0.1.1). It also features an IPv6 Address with Prefix section with an input field and Add/Remove buttons.
- WIFI Section:** Includes Adapter Enabled (toggle on), Domain (localdomain), DHCP Enabled (toggle on), IP Address (0.0.0.0), Subnet Mask (0.0.0.0), and Default Gateway (0.0.0.0). It also has a Scan WiFi Access Points button, a Select Discovered Access Points search field, an Add Access Points button, and a table of discovered access points.

SSID	Encryption Key	Password	Active Access Point	
<input type="checkbox"/>	Hammons1	WPA2	*****	<input type="checkbox"/>

NOTE: The IP Address, Subnet Mask, and Default Gateway fields are required only if DHCP is turned off for Ethernet and Wi-Fi network connections.

- **Hostname:** Enter the touch screen host name.
- **IPv6 Enabled:** Turn on the toggle to use IPv6 addressing for the touch screen.
- **Primary Static DNS (IPv6):** If **IPv6 Enabled** is turned on, enter the primary DNS address used to resolve the touch screen domain to an IPv6 address.
- **Secondary Static DNS (IPv6):** If **IPv6 Enabled** is turned on, enter the secondary DNS address used to resolve the touch screen domain to an IPv6 address.
- **Primary Static DNS (IPv4):** Enter the primary DNS address used to resolve the touch screen domain to an IPv4 address.
- **Secondary Static DNS (IPv4):** Enter the secondary DNS address used to resolve the touch screen domain to an IPv4 address.

Select the + (plus) icon next to **Primary LAN** to display the following Ethernet settings:

- **Adapter Enabled:** Turn on the toggle to use the touch screen Ethernet adapter, which allows the touch screen to make an Ethernet connection.
- **Domain:** Enter the fully qualified domain name on the network.
- **IPv4:** Use these settings to configure IPv4 Ethernet addressing on the network.
 - **DHCP:** Turn on the toggle to use DHCP for the IPv4 Ethernet connection.

NOTE: If DHCP is turned on, IP does not function until a reply has been received from the server. The touch screen broadcasts requests for an IP address periodically.

- **IP Address:** Enter the touch screen IPv4 Ethernet address on the network.
- **Subnet Mask:** Enter the touch screen subnet mask address on the network.
- **Default Gateway:** Enter the gateway router address on the network.
- **IPv6:** Use these settings to configure IPv6 Ethernet addressing on the network.
 - **Default Gateway:** Enter the gateway router address on the network.
 - **IPv6 Address with Prefix:** With **IPv6 Enabled** turned on, use the provided table to add IPv6 Ethernet addresses to the touch screen.
 - Select **Add** to add a new IPv6 Ethernet address to the touch screen.
 - Enter the following information for each entry:
 - Enter the IPv6 Ethernet address into the **Enter IPv6 Address** text field.
 - Enter the prefix for the IPv6 Ethernet address into the text field following the address.
 - If desired, use the copy button  to copy the IPv6 Ethernet address to the clipboard.
 - To remove an entry, fill the checkbox to the left of the table entry, and then select **Remove**.

NOTE: An "x" icon is shown to the right of the IPv6 Ethernet address prefix in a table row if the IPv6 address format is invalid or is missing a prefix. Hover over the icon to view a message explaining the issue.

Select the + (plus) icon next to **Wi-Fi** to display the following Wi-Fi network settings:

- **Adapter Enabled:** Turn on the toggle to use the touch screen Wi-Fi adapter, which allows the touch screen to make a Wi-Fi network connection.
- **Domain:** Enter the fully qualified domain name on the network.
- **IPv4:** Use these settings to configure IPv4 Wi-Fi network addressing on the network.
 - **DHCP:** Turn on the toggle to use DHCP for the IPv4 Wi-Fi network connection.

NOTE: If DHCP is turned on, IP does not function until a reply has been received from the server. The touch screen broadcasts requests for an IP address periodically.

- **IP Address:** Enter the touch screen IPv4 Wi-Fi network address on the network.
- **Subnet Mask:** Enter the touch screen subnet mask address on the network.
- **Default Gateway:** Enter the gateway router address on the network.
- **Wi-Fi Access Points**
 - **Scan Wi-Fi Access Points:** Scans the network for any open Wi-Fi access points. All discovered access points are displayed in the **Select Discovered Access Points** menu.
 - **Select Discovered Access Points:** Select an access point after completing a scan. Enter text in the search field to search for a specific Wi-Fi access point name.
 - **Add Access Points:** Adds the chosen access point entry from the **Select Discovered Access Points** field to the table below.

Each added Wi-Fi access point is displayed in a table that contains the following information.

- **SSID:** Enter or modify the SSID (name) of the Wi-Fi access point.
- **Encryption Key:** Select the security/encryption type used by the Wi-Fi access point.
- **Password:** Enter the password used to connect to the Wi-Fi access point.
- **Active Access Point:** Indicates whether a connection to the Wi-Fi access point is active

Select **Add** to add a new entry to the Wi-Fi access point table. After selecting one more entries in the Wi-Fi access point table, select **Remove** to delete the selected entries.

Services

Select **Services** to configure Crestron Fusion® software settings.

Settings Tab - Services

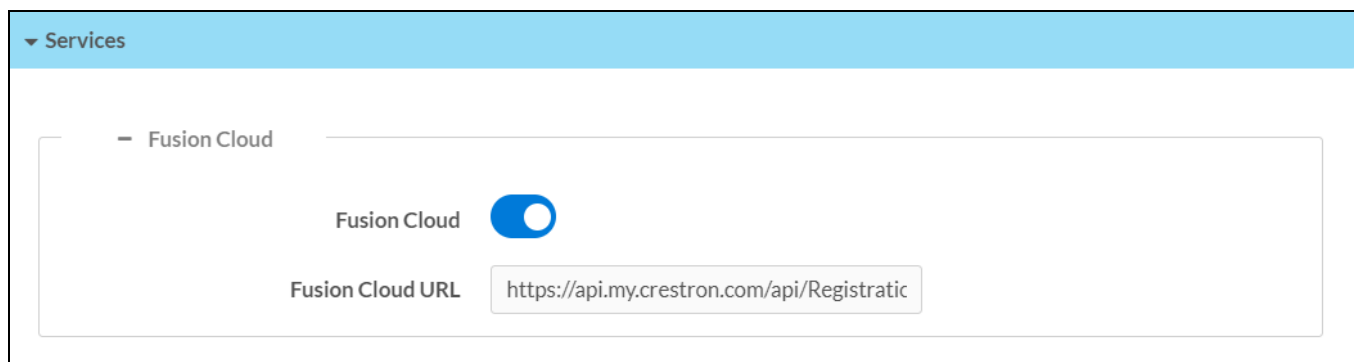

NOTE: If connecting to a Crestron Fusion software on-premises server, connections are made using either traditional (outbound) or inbound communications. For more information, refer to the [Crestron Fusion 10 On-Premises Software Getting Started Guide](#).

- **Crestron Fusion Cloud:** Turn on the toggle to allow a connection to a Crestron Fusion Cloud server. This connection is only applicable when the scheduling mode is set to **Crestron Default** or **User Project**.
- **Crestron Fusion Cloud URL:** Enter the URL used to connect the touch screen to the desired Crestron Fusion Cloud server.

Network Proxy Settings

Select **Network Proxy Settings** to configure network proxy settings for the touch screen.

Settings Tab – Network Proxy Settings

▼ Network Proxy Settings

Proxy

— HTTP Settings

HTTP Proxy

HTTP Proxy Address

HTTP Proxy Port

Username

Password

— HTTPS Settings

HTTPS Proxy

HTTPS Proxy Address

HTTPS Proxy Port

Username

Password

- **Proxy:** Turn on the toggle to configure the touch screen for use with a proxy server.
- **HTTP Settings**
 - **HTTP Proxy:** Turn on the toggle to use an HTTP proxy server.
 - **HTTP Proxy Address:** Enter the IP address of the HTTP proxy server.
 - **HTTP Proxy Port:** Enter the port number of the HTTP proxy server.
 - **Username:** Enter the username required for the HTTP proxy server.
 - **Password:** Enter the password required for the HTTP proxy server.
- **HTTPS Settings**
 - **HTTPS Proxy:** Turn on the toggle to use an HTTPS proxy server.
 - **HTTPS Proxy Address:** Enter the IP address of the HTTPS proxy server.
 - **HTTPS Proxy Port:** Enter the port number of the HTTPS proxy server.
 - **Username:** Enter the username required for the HTTPS proxy server.
 - **Password:** Enter the password required for the HTTPS proxy server.

Device Pairing

Select **Device Pairing** to configure settings for pairing the touch screen to a CEN-ODT-C-POE. The CEN-ODT-C-POE provides local occupancy reporting for supported room scheduling apps.

NOTE: For more information on the occupancy sensor, refer to the [CEN-ODT-C-POE Supplemental Guide](#). For more information on configuring the occupancy source in the Crestron scheduling application, refer to the [Crestron Room Scheduling Panels Operations Guide](#).

Settings Tab – Device Pairing

▼ Device Pairing

Device Model

Pairing Retry Time (Mins)

Pairing Status Offline

Device IP Address/FQDN Device IP Address/FQDN is invalid

– Device Authentication

Device Username

Device Password

- **Device Model:** Use the drop-down menu to select **POE Occ Sensor**.
- **Pairing Retry Time (Min):** Enter a duration (in minutes) that must elapse before the CEN-ODT-C-POE reattempts to pair to the touch screen.
- **Pairing Status:** Reports whether the CEN-ODT-C-POE is paired to the touch screen (**Online**) or not (**Offline**).

Device IP Address/FQDN: Enter the IP address or fully qualified domain name of the CEN-ODT-C-POE. This is required for device pairing.

Device Authentication: Enter authentication credentials for the CEN-ODT-C-POE (if required):

- **Device Username:** Enter a valid username used to access the device.
- **Device Password:** Enter a valid password used to access the device.

Audio

Select **Audio** to configure various audio settings for the touch screen.

Settings Tab – Audio

The screenshot shows the 'Audio' settings tab. Under the 'Device Audio' section, there are six settings:

- Panel Mute:** A toggle switch that is currently turned off.
- Panel Volume:** A slider set to 75%.
- Media Mute:** A toggle switch that is currently turned off.
- Media Volume:** A slider set to 100%.
- Beep Enabled:** A toggle switch that is currently turned on.
- Beep Volume:** A slider set to 75%.

NOTE: The **Media Volume** setting adjusts the H.264 streaming media level in relation to the **Panel Volume** setting.

- **Panel Mute:** Turn on the toggle to mute the main touch screen volume.
- **Panel Volume:** Enter a value (1–100) for the main touch screen volume level.
- **Media Mute:** Turn on the toggle to mute the touch screen media volume.
- **Media Volume:** Enter a value (1–100) for the touch screen media volume level.
- **Beep Enabled:** Turn on the toggle to mute the touch screen beep volume.
- **Beep Volume:** Enter a value (1–100) for the touch screen beep volume.

Auto Update

Select **Auto Update** to configure automatic firmware updates for the touch screen.

NOTE: The **Auto Update** accordion can be used to configure auto update settings for firmware only. Automatic application updates are not affected by these settings.

Settings Tab - Auto Update

Auto Update

Custom URL

Custom URL Path

- Schedule

Day of Week

Time of Day

Poll Interval Minutes

- **Auto Update:** Turn on the toggle to use automatic firmware updates.
- **Custom URL:** Turn on the toggle use a custom update server URL. If turned off, the server URL will default to the standard Crestron update sever.
- **Custom URL Path:** If **Custom URL Path** is turned on, enter the custom URL path for the update server.
- **Day of Week:** Select the day of week when the touch screen will check for updates. Select Daily to have the touch screen check for updates every day.
- **Time of Day:** Enter a time of day (in 24-hour format) when the touch screen will check updates on the scheduled day.
- **Poll Interval:** Enter the polling interval (in hours) for when the touch screen will poll the server for updates.
- Select **Update Now** to check the update server for new firmware and to update the touch screen immediately if new firmware is available.

Cloud Settings

Select **Cloud Settings** to enable or disable a connection between the touch screen and an XiO Cloud® service account. A connection to the XiO Cloud service is enabled by default.

Settings Tab – Cloud Settings

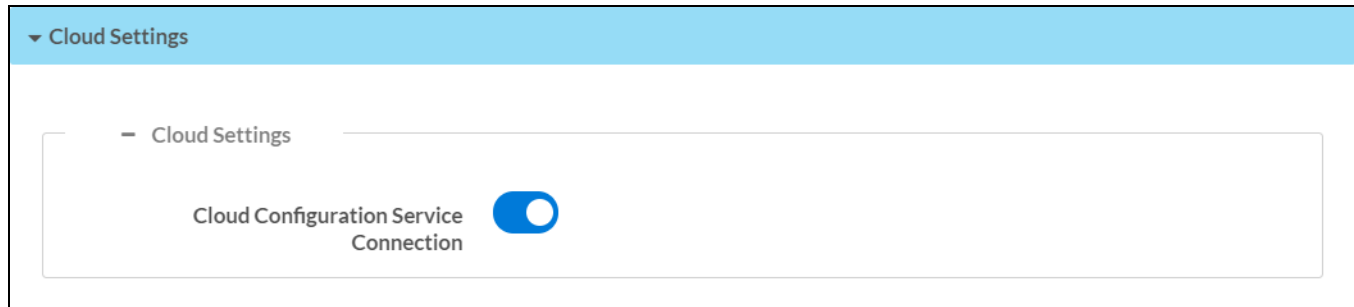

Turn on the **Cloud Configuration Service Connection** to allow a connection between the touch screen and an XiO Cloud account. This setting is turned on by default.

For more information on connecting to the XiO Cloud service, refer to [Connect to XiO Cloud Service](#).

Applications

Select **Applications** to select an application to run on the touch screen.

Settings Tab - Applications

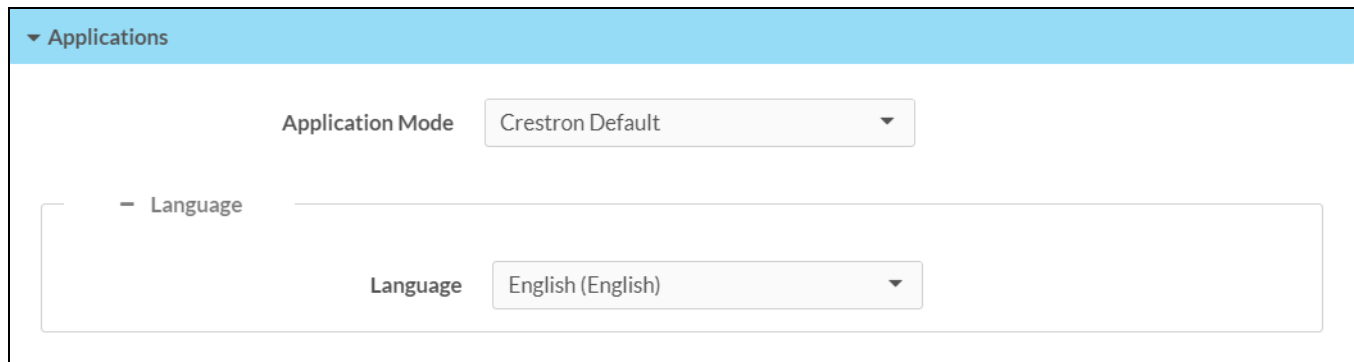

Use the **Application Mode** drop-down menu to select a touch screen application from the available selections. **User Project** is selected by default.

Once a new application is selected, select **Save Changes** from the **Actions** menu. A pop-up dialog box is displayed stating that the touch screen must be rebooted for the new application to take effect. Select **Yes** to restart the touch screen now or **No** to restart the touch screen later. The touch screen restarts with the new application running.

NOTE: Each application uses a unique setup procedure for registering and configuring the application. For more information on supported applications, refer to [Application Selection on page 134](#).

SNMP Configuration

Select **SNMP Configuration** to configure SNMP (Simple Network Management Protocol) settings on the touch screen.

Settings Tab - SNMP Configuration

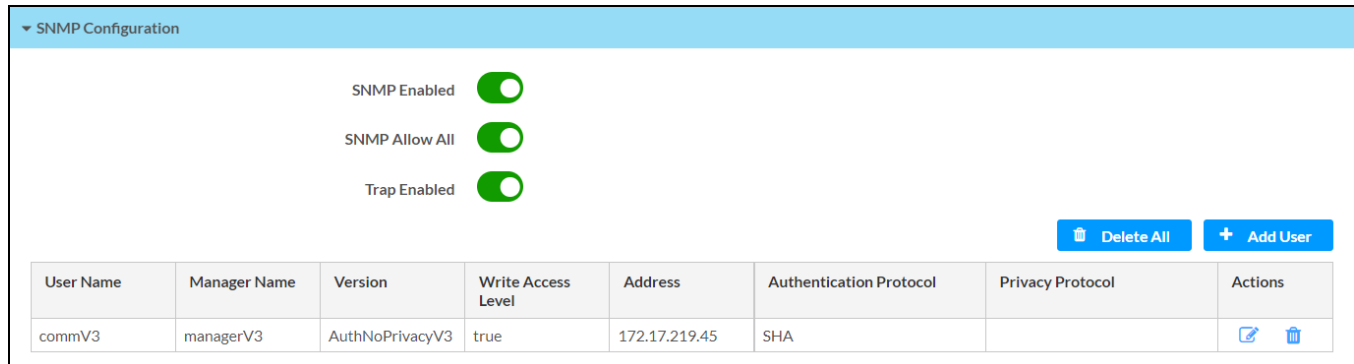



SNMP Configuration

SNMP Enabled

SNMP Allow All

Trap Enabled

Delete All Add User

User Name	Manager Name	Version	Write Access Level	Address	Authentication Protocol	Privacy Protocol	Actions
commV3	managerV3	AuthNoPrivacyV3	true	172.17.219.45	SHA		 

- **SNMP Enabled:** Turn on the toggle to turn on SNMP for the touch screen.
- **SNMP Allow All:** Turn on the toggle to all the touch screen to receive SNMP requests from all managers.
- **Trap Enabled:** Turn on the toggle to turn on SNMP trap notifications.

Each added SNMP user is displayed in a table that contains the following information.

- **User Name:** The name of the SNMP user
- **Manager Name:** The SNMP manager for the user
- **Version:** The SNMP version set for the user
- **Write Access Level:** Indicates whether the user has write level permissions (**true**) or read-only permissions (**false**)
- **Address:** The IP address of the SNMP manager
- **Authentication Protocol:** The authentication protocol used by the SNMP manager
- **Privacy Protocol:** The privacy protocol used by the SNMP manager
- **Actions:** Controls for editing and deleting the SNMP user

Select **Delete All** to delete all existing SNMP users. When a dialog box is shown asking whether all SNMP users should be deleted, select **Yes**.

Select **Add User** to add a new SNMP user. The **Add SNMP Configuration** dialog box is displayed.

Add SNMP Configuration Dialog Box

The screenshot shows a dialog box titled "Add SNMP Configuration". It contains the following fields and controls:

- Manager Name * (text input)
- IP Address/Host Name * (text input)
- Community Name * (text input)
- Write Access Level (dropdown menu: Please Select Access Level)
- SNMP Version * (dropdown menu: Please Select SNMP Version)
- SNMP Authorization Protocol (dropdown menu: None)
- SNMP Privacy Protocol (dropdown menu: None)
- SNMP Security Password (password input)
- SNMP Privacy Password (password input)

Buttons: OK, CANCEL

Enter the following information for the SNMP user:

- **Manager Name:** Enter the SNMP manager name for the user.
- **IP Address/Host Name:** Enter the IP address or host name of the SNMP manager.
- **Community Name:** Enter the SNMP community (user) name.
- **Write Access Level:** Use the drop-down menu to select whether the user has write level access (**True**) or read-only access (**False**).
- **SNMP Version:** Use the drop-down menu to select the SNMP version used by the manager.
- **SNMP Authorization Protocol:** If required, use the drop-down menu to select the authorization protocol used by the SNMP manager.
- **SNMP Privacy Protocol:** If required, use the drop-down menu to select the privacy protocol used by the SNMP manager.
- **SNMP Security Password:** If required, enter the security password for the SNMP manager.
- **SNMP Privacy Password:** If required, use the privacy password for the SNMP manager.

Select **OK** to create the new user. The user is added to the table within the **SNMP Configuration** accordion.

Security

Select the **Security** tab on the top left of the configuration interface to display selections for configuring security and authentication settings for the touch screen.

Security Tab Selections

Expand the **Security** accordion to configure the following settings:

- **SSL Mode:** Select an SSL (Secure Sockets Layer) mode to use for establishing a secure connection to the touch screen:
 - **Encrypt and Validation:** The touch screen will require a username and password to validate an encrypted SSL connection. Enter a username and password in the appropriate fields that are displayed.
 - **Encrypt:** The touch screen will use an encrypted SSL connection
 - **OFF:** The touch screen will not use an SSL connection.

User and group settings are also displayed within the **Security** accordion.

Authentication Settings

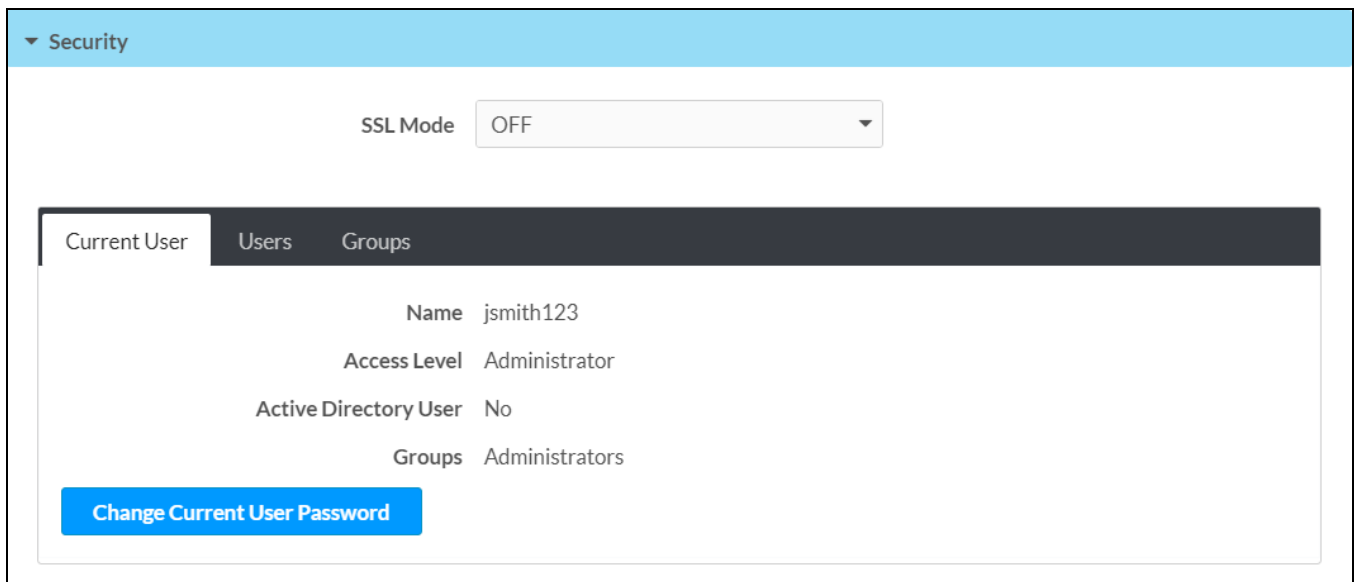

The screenshot shows the Security configuration interface. At the top, there is a blue header with a dropdown arrow and the text "Security". Below this, the "SSL Mode" is set to "OFF" in a dropdown menu. Underneath, there are three tabs: "Current User", "Users", and "Groups". The "Current User" tab is active, displaying the following information: Name: jsmith123, Access Level: Administrator, Active Directory User: No, and Groups: Administrators. At the bottom of the "Current User" section, there is a blue button labeled "Change Current User Password".

The web configuration interface prompts the user to enter a new administrator username and password. After restarting the touch screen, this username and password must be entered to access the web configuration utility or to connect to the touch screen through Crestron Toolbox™ software.

CAUTION: Do not lose the administrator username and password, as the touch screen settings must be restored to factory defaults to reset the username and password.

Use the following settings to add, delete, and edit touch screen users and groups.

Current User

Select the **Current User** tab to view and edit information for the current touch screen user.

Current User Tab

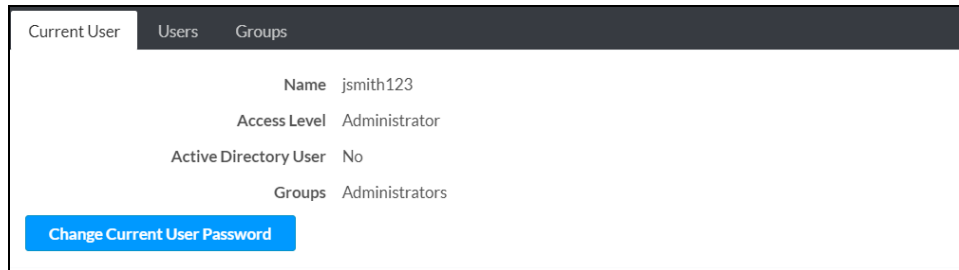

Current User	Users	Groups
Name	jsmith123	
Access Level	Administrator	
Active Directory User	No	
Groups	Administrators	
Change Current User Password		

The following settings are displayed for the current user:

- **Name:** The chosen username
- **Access Level:** The access level granted to the user (**Administrator**, **Programmer**, **Operator**, **User**, or **Connect**)
- **Active Directory User:** Reports whether the current user is (**Yes**) or is not (**No**) authenticated through Active Directory® software

NOTE: A user must be added to an Active Directory group before the user may be selected as an active directory user. For more information, refer to [Groups on page 128](#).

- **Groups:** Any groups of which the current user is a member

Select **Change Current User Password** to change the password for the current user. The **Change Password** dialog box is displayed.

Change Password Dialog Box

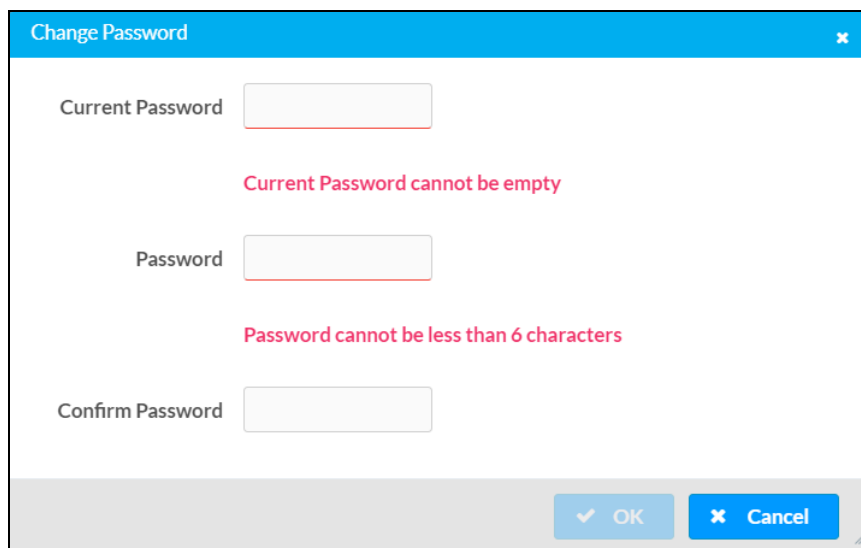

Change Password

Current Password

Current Password cannot be empty

Password

Password cannot be less than 6 characters

Confirm Password

✓ OK ✕ Cancel

Enter the existing password in the **Current Password** field. Then, enter a new password in the **Password** field, and reenter the password in the **Confirm Password** field.

Select **OK** to save the new password, or select **Cancel** to cancel the change.

Users

Select the **Users** tab to view and edit information for the touch screen users.

Users Tab

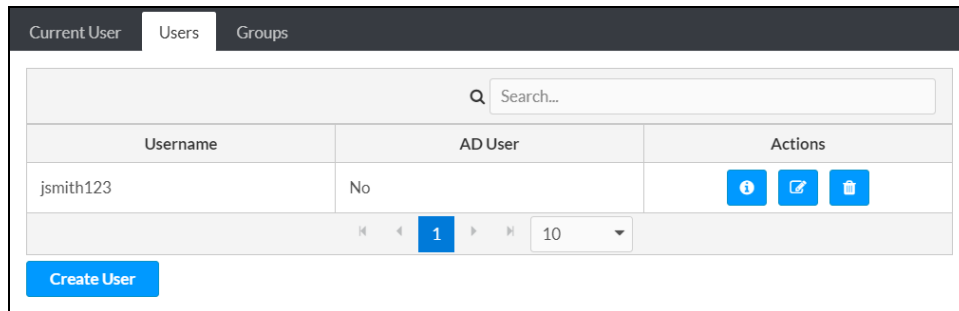

Enter text into the **Search Users** field to find and display users that match the search term(s).

Touch screen users are listed in table format. The following information is displayed for each touch screen user:

- **Username:** The chosen username
- **AD User:** Reports whether the user is (**Yes**) or is not (**No**) authenticated through Active Directory

NOTE: A user must be added to an Active Directory group before the user may be selected as an active directory user. For more information, refer to [Groups on page 128](#).

If the touch screen users span multiple pages, use the navigation arrows on the bottom of the page to move forward or backward through the pages, or select a page number to navigate to that page. Additionally, the number of users displayed on each page may be set to 5, 10, or 20 users.

An **Actions** column is also provided for each user that allows various actions to be performed. The following selections may be selected from the **Actions** column.

User Details

Select the information button  in the **Actions** column to view information for the selected user. The **User Details** pop-up dialog box is displayed.

User Details Dialog Box

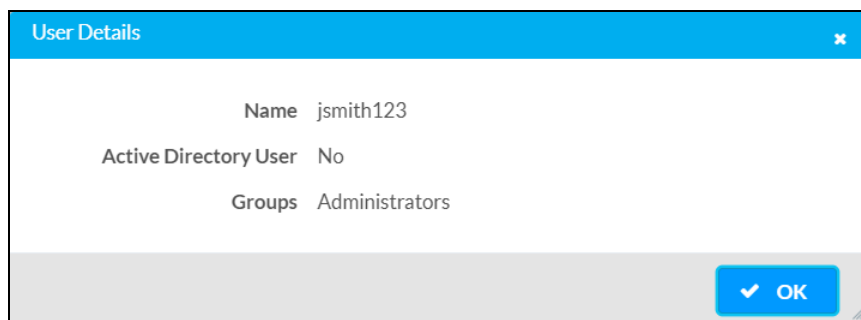

The following settings are displayed for the current user:

- **Name:** The chosen username
- **Active Directory User:** Reports whether the user is (**Yes**) or is not (**No**) authenticated through Active Directory
- **Groups:** Lists any groups that contain the user

Select **OK** to return to the **Authentication Management > Users** page.

Update User

Select the editing button  in the **Actions** column to edit settings for the selected user. The **Update User** dialog box is displayed.

Update User Dialog Box

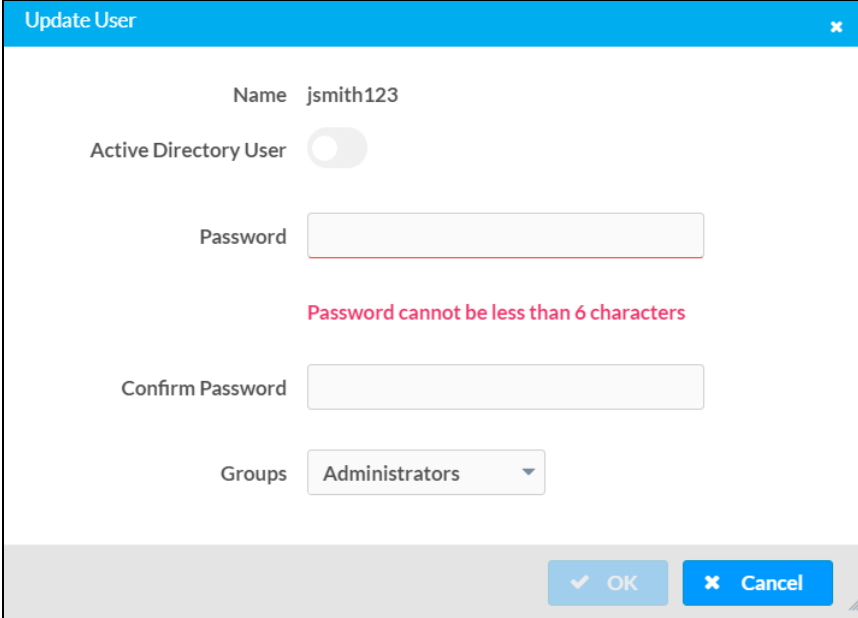

The following **Update User** settings may be viewed or configured:

- **Name:** The chosen username
- **Active Directory User:** Turn on the toggle to use authentication via Active Directory for the selected user.
- **Password:** Enter a new password for the selected user.
- **Confirm Password:** Reenter the password provided in the **Password** field.
- **Groups:** Add the user to one or more groups. For more information, refer to [Groups on page 128](#).

NOTE: A user must be added to an Active Directory group to be selected as an Active Directory user.

Select **OK** to save any changes and to return to the **Authentication Management > Users** page. Select **Cancel** to cancel any changes.

Delete User

Select the trashcan icon  in the **Actions** column to delete the user.

A pop-up dialog box is displayed asking whether the user should be deleted. Select **Yes** to delete the user or **No** to cancel deleting the user.

Create User

Select **Create User** at the bottom of the page to create a new touch screen user. The **Create User** dialog box is displayed.

Create User Dialog Box

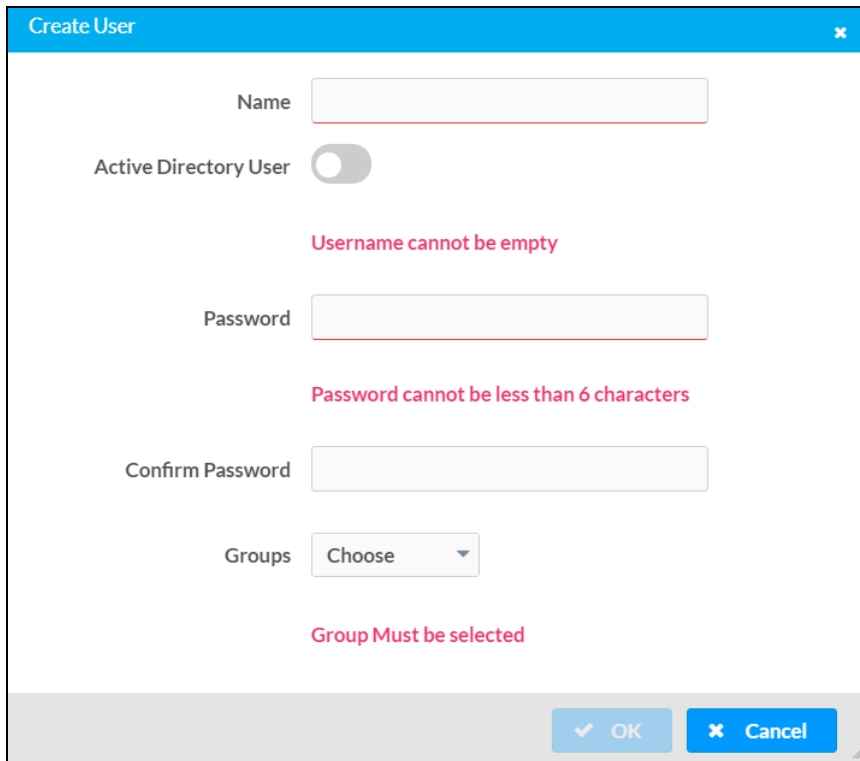

Create User

Name

Active Directory User

Username cannot be empty

Password

Password cannot be less than 6 characters

Confirm Password

Groups Choose ▾

Group Must be selected

✓ OK ✕ Cancel

Use the following settings to create a new user:

- **Name:** Enter a username.
- **Active Directory User:** Turn on the toggle to use authentication via Active Directory for the user.
- **Password:** Enter a password for the user.
- **Confirm Password:** Reenter the password provided in the **Password** field.
- **Groups:** Add the user to one or more groups. For more information, refer to [Groups on page 128](#).

NOTE: A user must be added to an Active Directory group to be selected as an Active Directory user.

Select **OK** to save any changes and to return to the **Authentication Management > Users** page. Select **Cancel** to cancel creating a new user.







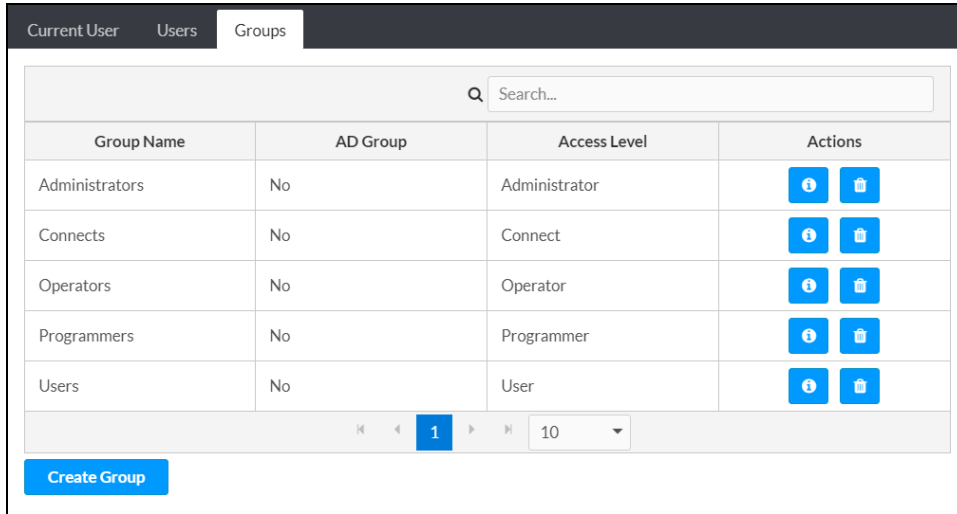



Groups

Select the **Groups** tab to view and edit settings for touch screen groups. Touch screen groups are used to group users by access level and Active Directory authentication settings.

Groups Tab



The screenshot shows a web interface with three tabs: 'Current User', 'Users', and 'Groups'. The 'Groups' tab is active. At the top, there is a search bar labeled 'Search...'. Below it is a table with the following columns: 'Group Name', 'AD Group', 'Access Level', and 'Actions'. The table lists five groups: Administrators, Connects, Operators, Programmers, and Users. Each group has an 'AD Group' of 'No' and an 'Access Level' (Administrator, Connect, Operator, Programmer, User). The 'Actions' column contains two blue icons: an information icon and a trash icon. At the bottom of the table, there are navigation arrows and a page number '1' in a blue box, followed by a dropdown menu set to '10'. A 'Create Group' button is located at the bottom left of the interface.

Group Name	AD Group	Access Level	Actions
Administrators	No	Administrator	 
Connects	No	Connect	 
Operators	No	Operator	 
Programmers	No	Programmer	 
Users	No	User	 

Enter text in to the **Search Groups** field to find and display groups that match the search term(s).

Touch screen groups are listed in table format. The following information is displayed for each touch screen group:

- **Group Name:** The chosen group name
- **AD Group:** Reports whether the group is (**Yes**) or is not (**No**) authenticated through Active Directory

NOTE: Active Directory provides an additional layer of authentication for touch screen groups and users. Active directory group and user names are stored in the touch screen console along with a unique SID (security identifier). When an Active Directory user attempts to authenticate against the console, the console first checks the user credentials. If the Active Directory authentication is successful, Active Directory queries the console for the user or group's SID. The user is granted access to the touch screen only if at least one SID match is found.

- **Access Level:** The access level for the selected group (**Administrator, Programmer, Operator, User, or Connect**)

If the touch screen groups span multiple pages, use the navigation arrows on the bottom of the page to move forward or backward through the pages, or select a page number to navigate to that page. Additionally, the number of groups displayed on each page may be set to 5, 10, or 20 users.

An **Actions** column is also provided for each group that allows various actions to be performed. The following selections may be selected from the **Actions** column.

Group Details

Select the information button  in the **Actions** column to view information for the selected group. The **Group Details** dialog box is displayed.

Group Details Dialog Box

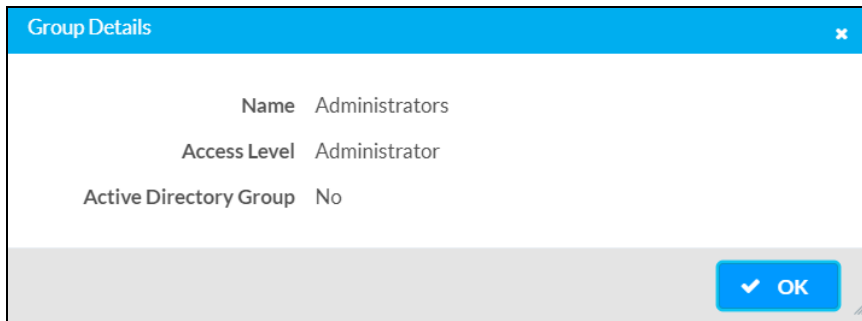

The following settings are displayed for the current group:

- **Name:** The chosen group name

NOTE: If authenticating with Active Directory, do not enter the domain name for the Active Directory group in the **Name** field. If this information is being entered via console commands, omit `domain\local` from the command (for example, `addomaing -n:crestron -L:A` instead of `addomaing -n:domain.local\crestron -L:A`).

- **Access Level:** The access level of the group and its users
- **Active Directory User:** Reports whether the group is (**Yes**) or is not (**No**) authenticated through Active Directory

Select **OK** to return to the **Authentication Management > Groups** page.

Delete Group

Select the trashcan icon  in the **Actions** column to delete the group.

A pop-up dialog box is displayed asking whether the group should be deleted. Select **Yes** to delete the group or **No** to cancel deleting the group.

Create Group

Select **Create Group** at the bottom of the page to create a new touch screen group. The **Create Group** dialog box is displayed.

Create Group Dialog Box

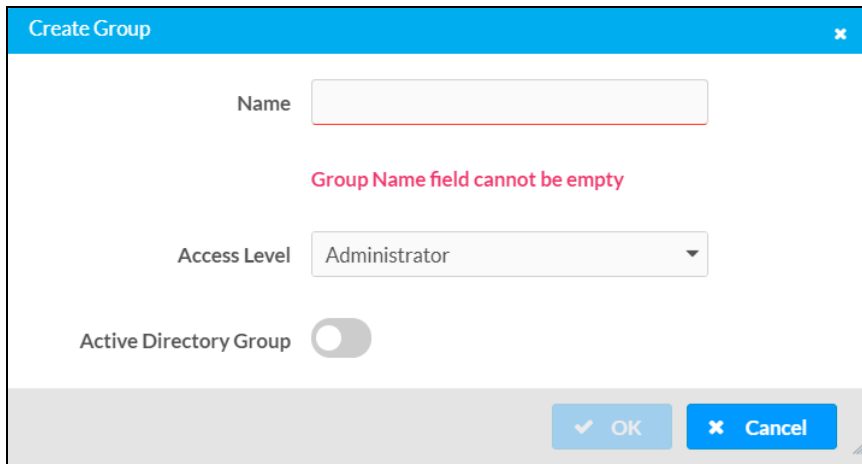

The screenshot shows a 'Create Group' dialog box with the following elements:

- Name:** An empty text input field with a red error message below it: "Group Name field cannot be empty".
- Access Level:** A dropdown menu currently set to "Administrator".
- Active Directory Group:** A toggle switch that is currently turned off.
- Buttons:** "OK" (with a checkmark icon) and "Cancel" (with an 'X' icon) buttons at the bottom right.

Use the following settings to create a new group:

- **Name:** Enter a group name.
- **Access Level:** Select an access level for the group and its users from the drop-down menu.
- **Active Directory Group:** Turn on the toggle to use authentication via Active Directory for the group.

Select **OK** to save any changes and to return to the **Authentication Management > Groups** page. Select **Cancel** to cancel creating a new group.

802.1x Configuration

Select the **802.1x Configuration** tab on the top left of the configuration interface to display selections for configuring IEEE 802.1X network authentication for touch screen security.

802.1x Configuration Tab Selections

The screenshot displays the configuration interface for IEEE 802.1x authentication. At the top, a navigation bar includes tabs for Status, Settings, Security, and 802.1x Configuration. The 802.1x Configuration tab is active, showing a sub-header '802.1x Configuration' with a dropdown arrow. Below this, the 'IEEE 802.1x Authentication' section features a toggle switch that is currently turned off. Underneath, the 'Authentication Method' is set to 'EAP MSCHAP V2- password' in a dropdown menu. There are three input fields: 'Domain', 'Username', and 'Password' (the latter is masked with dots). The 'Enable Authentication Server Validation' section also has a toggle switch that is turned off. Below this, the 'Select Trusted Certificate Authoritie(s)' section contains a search bar and a scrollable list of certificate authorities, each with an unchecked checkbox. The list includes: AAA Certificate Services, AC RAIZ FNMT-RCM, ACCVRAIZ1, Actalis Authentication Root CA, AffirmTrust Commercial, AffirmTrust Networking, AffirmTrust Premium ECC, AffirmTrust Premium, Amazon Root CA 1, Amazon Root CA 2, Amazon Root CA 3, Amazon Root CA 4, Atos TrustedRoot 2011, and Autoridad de Certificacion Firmaprofesional CIF A62634068.

Expand the **802.1x Configuration** accordion to configure the following settings:

- **IEEE 802.1x Authentication:** Turn on the toggle to use 802.1X authentication for the touch screen.
- **Authentication Method:** Select an 802.1X authentication method (**EAP-TLS Certificate** or **EAP MSCHAP V2- password**) from the drop-down menu.
- **Domain:** If **EAP MSCHAP V2- password** is selected for **Authentication Method**, enter a domain name that is required for authentication.
- **Username:** If **EAP MSCHAP V2- password** is selected for **Authentication Method**, enter a username that is required for authentication.
- **Password:** If **EAP MSCHAP V2- password** is selected for **Authentication Method**, enter a password that is required for authentication.
- **Enable Authentication Server Validation:** Turn on the toggle to use server validation for increased security.
- **Select Trusted Certificate Authorities:** Select trusted CAs (Certificate Authorities) from the provided CAs to be used for server validation:
 - Select the check box to the left of a CA to select it as a trusted CA.
 - Enter a search term into the text field at the top of the CA menu to search for and display CAs that match the search term.
 - Select the check box to the left of the search field at the top of the CA menu to select all CAs as trusted CAs.

Select **Manage Certificates** from the **Action** menu to add or remove CAs from the list. The **Manage Certificates** dialog box is displayed with the **Root** tab selected.

Manage Certificates Dialog Box - Root Tab

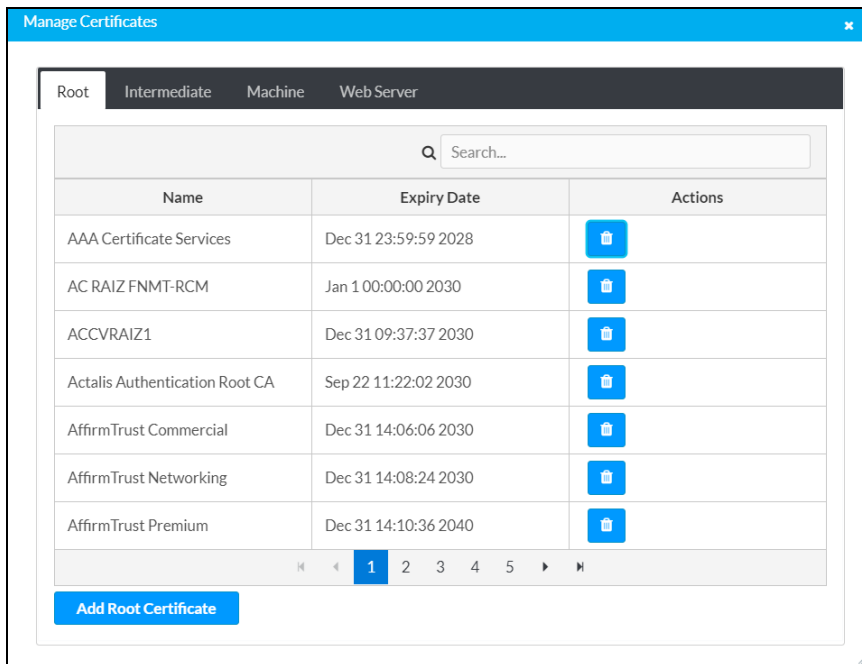

Select the tabs near the top of the page to switch between the different types of CAs (**Root**, **Intermediate**, **Machine**, or **Web Server**). The same settings are provided for each type of CA.

Type a search term into the **Search...** text field to search for and display CAs that match the search term.

The following information is provided for each type of CA:

- **Name:** The CA name
- **Expiry Date:** The date and time that the CA is set to expire

If the CAs span multiple pages, use the navigation arrows on the bottom of the page to move forward or backward through the pages, or select a page number to navigate to that page.

Select the trashcan button  in the **Actions** column for a CA to delete it. A pop-up dialog box is displayed asking if the CA should be deleted. Select **Yes** to delete the certificate or **No** to cancel.

Select **Add [Type] Certificate** to add a CA of one of the four available types (**Root**, **Intermediate**, **Machine**, or **Web Server**) to the list of CAs. The **Add Certificate** pop-up dialog box is displayed.

Add Certificate Dialog Box

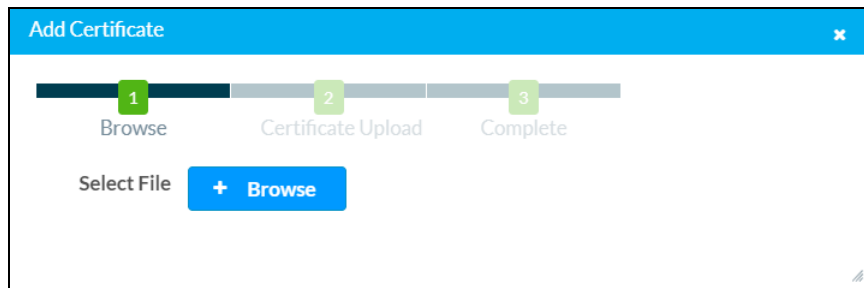

To add a new certificate:

1. Select **Browse**.
2. Navigate to the CA file on the host computer.
3. Select the CA file, and then select **Open**.
4. Select **Load** to load the CA file to the touch screen. The upload progress is shown in the dialog box.
5. Once the touch screen has completed the upload, select **OK**.

Select the **x** button to close the **Add Certificate** dialog box at any time during the upload process. Selecting the **x** button before the CA file is uploaded to the touch screen cancels the upload.

Select the **x** button to close the **Manage Certificates** dialog box and to return to the **802.1x Authentication** page.

Application Selection

The touch screen ships with a variety of preinstalled applications that provide out-of-the-box functionality. Once an application has been selected, it downloads from the cloud and installs on the touch screen automatically.

The following applications ship with the touch screen:

- Crestron general web application¹
- [Crestron room scheduling](#) application
- [22 Miles® ADSign](#) application²
- [Appspace® digital signage](#) application
- [AskCody® room scheduling](#) application
- [Door Tablet® room scheduling](#) application
- [EMS Software® room scheduling](#) application
- [Envoy® room scheduling](#) application
- [Gingco.net™ room scheduling](#) application
- [iOffice® room scheduling](#) application
- [Indoor Finders® room scheduling](#) application
- [Kardham Digital® room scheduling](#) application
- [Korbyt™ room scheduling](#) application
- [KuiqMeeting room scheduling](#) application
- [Matrix Booking® room scheduling](#) application
- [Microsoft Teams Scheduling Panels](#) application
- [NexBoard room scheduling](#) application
- [New Wave Apps® room scheduling](#) application
- [NFS™ Rendezvous room scheduling](#) application
- [OfficeSpace® room scheduling](#) application
- [PADS4 room scheduling](#) application
- [Pepperdash® room scheduling](#) application
- [Robin® room scheduling](#) application
- [SharingCloud™ room scheduling](#) application
- [Smartway2® room scheduling](#) application
- [Space Connect™ room scheduling](#) application
- [SpacelQ® room scheduling](#) application
- [Telelogos® Meeting4Display room scheduling](#) application
- [Teem® room scheduling](#) application
- [Zoom Rooms™ conferencing control and Zoom™ room scheduling](#) application

NOTE: Support for additional applications will be provided by future firmware updates.

The touch screen runs only one app, which is selected at setup. Only the apps approved and delivered by Crestron may run on the touch screen.

NOTE: Additional subscriptions and/or licenses may be required. Refer to each provider's website for details about the capabilities and requirements of its scheduling application and services.

For more information on using and setting up each application, refer to the provider's website.

Note:

1. The Crestron general web functionality allows a user to run a custom web application on the touch screen from a web server. The URL for the web application must be provided within the web configuration interface and must use the HTTPS protocol. For more information on selecting the application, refer to [Applications on page 120](#). For more information on using the Crestron general web functionality with a TSW-70 series light bar, refer to [online help answer ID 1001103](#).
2. The application supports RFID functionality via the Crestron RFID-USB card reader. The RFID-USB installs next to the touch screen and connects to it over USB. Refer to the touch screen firmware release notes for more information on the supported RFID functions.

Operation

The touch screen is controlled by using its capacitive touch screen display. The touch screen supports gesturing and swiping controls to perform various functions. Supported touch controls vary by application or program.



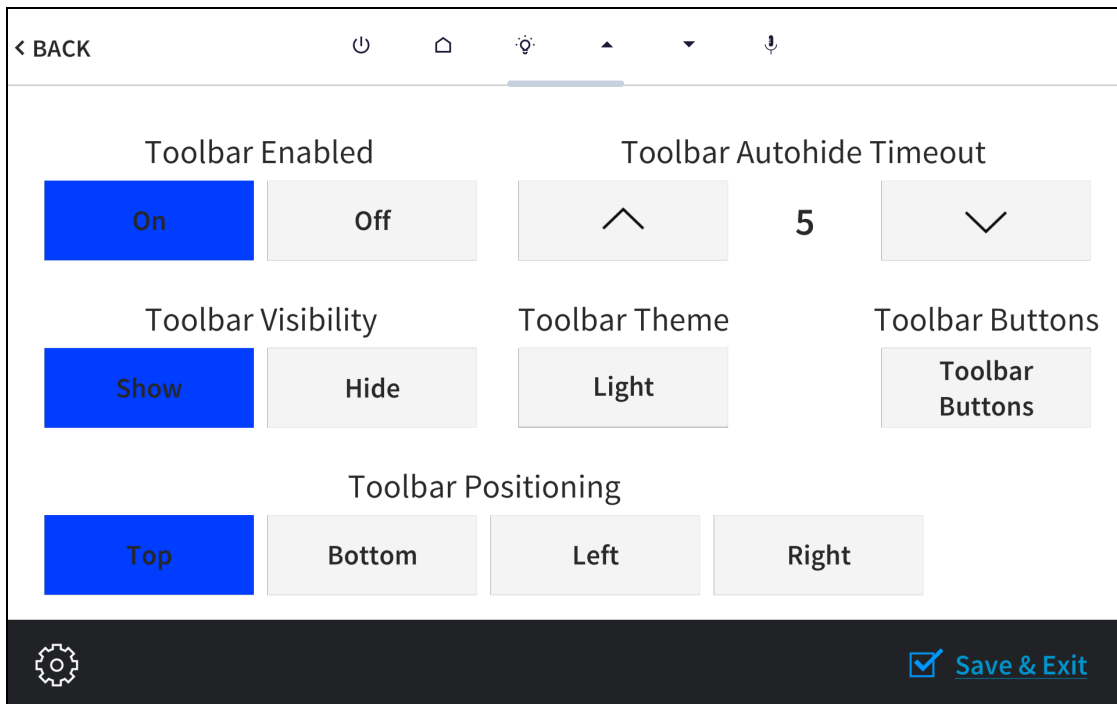

The virtual toolbar is used to perform basic device functions if it has been enabled. By default, the virtual toolbar can be accessed by swiping down on the tab located at the top of the screen. The toolbar can be hidden by swiping up on the tab or is hidden automatically after a set timeout duration.

On-screen Toolbar Screen (with Virtual Toolbar)



The following virtual buttons are provided by default and can be used to control the touch screen or the loaded application or program (if supported). Each button can be manually enabled or disabled in the local configuration pages.

NOTE: Virtual button functionality can be custom programmed using a Crestron control system.

- **Power**  : Powers the touch screen off.
- **Home**  : Returns to the home page of the application or program.
- **Lighting**  : Navigates to lighting controls in the application or program.
- **Up**  : Moves up a page in the application or program.

- **Down** ▼ : Moves down a page in the application or program.
- **Microphone** 🎤 : Enables or disables the microphone functionality.

For more information on configuring the virtual toolbar, refer to [Virtual Toolbar on page 89](#).

Resources

The following resources are provided for the TSS-70 Series.

NOTE: You may need to provide your Crestron.com web account credentials when prompted to access some of the following resources.

Crestron Support and Training

- [Crestron True Blue Support](#)
- [Crestron Resource Library](#)
- [Crestron Online Help \(OLH\)](#)
- [Crestron Training Institute \(CTI\) Portal](#)

Programmer and Developer Resources

- help.crestron.com: Provides help files for Crestron programming tools such as SIMPL, SIMPL#, and Crestron Toolbox™ software
- developer.crestron.com: Provides developer documentation for Crestron APIs, SDKs, and other development tools

Related Documentation

- [Crestron Fusion® Software Help File](#)
- [Crestron Programming Design Guide](#)
- [Crestron Room Scheduling Application Operations Guide](#)
- [Crestron Room Scheduling Application Programming Guide](#)
- [Crestron Room Scheduling Application User Guide](#)
- [TS-70 and TSW-70 Series Touch Screens Security Reference Guide](#)
- [XiO Cloud User Guide](#)

