

Crestron CLW-SWEX-E

Cameo® Express Wireless In-Wall Switch, 120 V

Installation Guide



Further Inquiries

To locate specific information or resolve questions after reviewing this guide, contact Crestron's True Blue Support at 1-888-CRESTRON [1-888-273-7876] or, for assistance within a particular geographic region, refer to the listing of Crestron worldwide offices at www.crestron.com/offices.

To post a question about Crestron products, log onto Crestron's Online Help at www.crestron.com/onlinehelp. First-time users must establish a user account to fully benefit from all available features.

Future Updates

As Crestron improves functions, adds new features, and extends the capabilities of the CLW-SWEX-E, additional information may be made available as manual updates. These updates are solely electronic and serve as intermediary supplements prior to the release of a complete technical documentation revision.

Check the Crestron website periodically for manual update availability and its relevance. Updates are identified as an "Addendum" in the Download column.

WARNING: To avoid fire, shock, or death, turn off power at circuit breaker or fuse and test that power is off before wiring!

NOTES:

- Observe the following points.
- To be installed or used in accordance with appropriate electrical codes and regulations.
- This product should be installed by a qualified electrician.

PREPARING AND CONNECTING WIRES

Strip the ends of the wires approximately 1/4 in (6 mm). Use care to avoid nicking the conductors. Twist together the ends of the wires that share a connection. Apply solder only to the ends of the twisted wires. Avoid tinning too far up the wires or the end becomes brittle.

Crestron Electronics, Inc.
15 Volvo Drive Rockleigh, NJ 07647
Tel: 888.CRESTRON
Fax: 201.767.7576
www.crestron.com

Installation Guide - DOC. 6819C
(2024290)



01.15
Specifications subject to
change without notice.

This product is Listed to applicable UL Standards and requirements by Underwriters Laboratories Inc.



FCC ID: Contains EROCWD6790

Compliance Statement (Part 15.19)

This device complies with part 15 of the FCC Rules. Operation is subject to the following two conditions:

- This device may not cause harmful interference, and
- this device must accept any interference received, including interference that may cause undesired operation.

Warning (Part 15.21)

Changes or modifications not expressly approved by the party responsible for compliance could void the user's authority to operate the equipment.

RF Exposure (OET Bulletin 65)

To comply with FCC's RF exposure limits for general population / uncontrolled exposure, this transmitter must be installed to provide a separation distance of at least 20 cm from all persons and must not be co-located or operating in conjunction with any other antenna or transmitter.

DESCRIPTION

The Crestron® CLW-SWEX-E is a Cameo® Express Wireless In-Wall Switch that features field-replaceable and engravable buttons. Configurable with two buttons or a rocker, the CLW-SWEX-E is more versatile than previous generations of in-wall switches. The Cameo Express line makes it possible to bring controlled lighting to every room in the home or office. Its streamlined design complements the entire line of Cameo dimmers, switches, and keypads, making it a great addition to new or retrofit installations. In addition to its attractive look and feel, infiNET EX® communication technology brings proven reliability to the CLW-SWEX-E.

Specifications

Specifications for the CLW-SWEX-E are listed in the following table.

CLW-SWEX-E Specifications

SPECIFICATION	DETAILS
Power Requirements	120 Vac, 60 Hz, line power
Load Types	CFL, Incandescent, Magnetic Low Voltage, Electronic Low Voltage, Tungsten-Halogen
Load Ratings	
Minimum Load	25 W
Incandescent/Tungsten Halogen/Magnetic Ballasts	1,000 VA/W
Electronic Ballasts/CFL	600 VA
Motor	1/2 HP
Wireless	
RF Transceiver	infiNET EX2-way RF, 2.4 GHz ISM Channels 11 to 26 (2400 to 2483.5 MHz), default channel 15; IEEE 802.15.4 compliant
Range (Typical)	150 ft (46 m) indoor, 250 ft (76 m) outdoor to nearest mesh network device(s); Subject to site-specific conditions and individual device compatibilities ¹
Gateway	Requires an infiNET EX gateway ²
Environmental	
Temperature	32° to 104°F (0° to 40°C)
Humidity	10% to 90% RH (non-condensing)
Connections	
Hot	(1) 14-12 AWG, screw terminal, brass, line power input
Load	(1) 14-12 AWG, screw terminal, red, load output
Neutral	(1) 14-12 AWG, screw terminal, silver, neutral ³
Ground	(1) 18 AWG Class 1 flying lead, green, ground (wire nut included)
Default RF ID	01
Dimensions	
Height	4 1/8 in (105 mm)
Width	1 3/4 in (45 mm)
Depth	1 3/4 in (45 mm)
Weight	5 oz (142 g)

- Any infiNET EX device that provides expander functionality effectively extends the range of the wireless network beyond the initial range of the gateway. Battery-powered infiNET EX devices do not provide expander functionality. A dedicated infiNET EX Wireless Expander, model CLW-EXPEX or GLA-EXPEX (both sold separately), is also available.
- Item(s) sold separately.
- A neutral wire is required for normal operation.

Important Notes (Read Before Installation)

CAUTION: TO REDUCE THE RISK OF OVERHEATING AND POSSIBLE DAMAGE TO OTHER EQUIPMENT, DO NOT INSTALL TO CONTROL A RECEPTACLE OR A TRANSFORMER-SUPPLIED APPLIANCE.

ATTENTION: GRADATEURS COMMANDANT UN BALLAST-AFIN DE RÉDUIRE LE RISQUE DE SURCHAUFFE ET LA POSSIBILITÉ D'ENDOMMAGEMENT À D'AUTRES MATÉRIELS, NE PAS INSTALLER POUR COMMANDER UNE PRISE OU UN APPAREIL ALIMENTÉ PAR UN TRANSFORMATEUR.

- Neutral: The CLW-SWEX-E requires a neutral connection to operate.
- Codes: Install in accordance with all local and national electrical codes.
- Wiring: Use copper wire only. For supply connections, use wires rated for at least 75°C.
- Lamp Type: For use with permanently installed incandescent, magnetic low voltage, tungsten-halogen, or CFL only.
- Temperature: For use where temperatures are between 32° to 104°F (0° to 40°C).

- Electrical Boxes: Devices mount in standard electrical boxes. For easy installation, use 3 1/2 in (89 mm) deep electrical boxes. Several devices can be installed in one electrical box (multigang). For a smooth appearance, one-piece multigang faceplates (not supplied) can be installed. When installing into a multigang box, do not fully tighten the devices to the box until the faceplate has been aligned.
- Switches: Mechanical 3- or 4-way switches do not work with the CLW-SWEX-E series switchers.
- Spacing: If mounting one device above another, leave at least 4 1/2 in (115 mm) vertical space between them.
- Low Voltage Applications: Operation of a low voltage circuit with all lamps inoperative or removed may result in current flow in excess of normal levels. To avoid transformer overheating and premature transformer failure, Crestron recommends the following:
 - > Do not operate low voltage circuits without operative lamps in place.
 - > Replace burned-out lamps as quickly as possible.
 - > Use transformers that incorporate thermal protection or fuse transformer primary windings to prevent transformer failure due to overcurrent.

INSTALLATION

The following describes the installation of a CLW-SWEX-E switch.

WARNING: Turn off power at the circuit breaker. Installing with the power on can result in serious personal injury and damage to the device.

WARNING: New installations should be checked for short circuits prior to installing a CLW-SWEX-E switch. With the power off, close the circuit and restore power. If the loads do not work or a breaker trips, check and correct the wiring or fixture (if necessary). Install the switch only when the short is no longer present. The warranty is void if the switch is installed and operated with a shorted load.

NOTE: Before using the CLW-SWEX-E, ensure the device is using the latest firmware. Check for the latest firmware for the CLW-SWEX-E at www.crestron.com/firmware. Firmware is loaded onto the device using Crestron Toolbox™.

- Turn power off at the circuit breaker.
- Wire the device as shown in the following diagram.

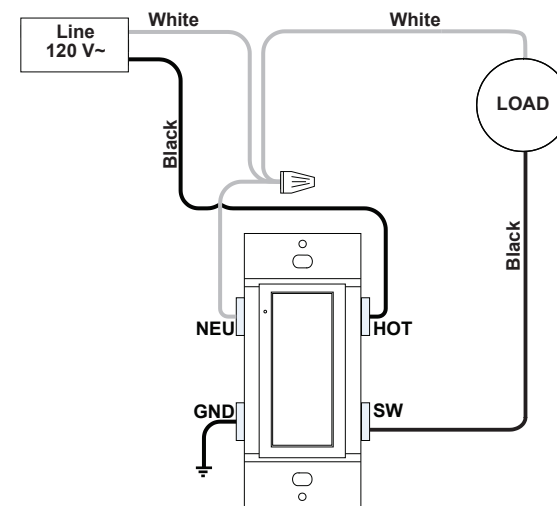

NOTE: Refer to the following diagram when making connections to the device.

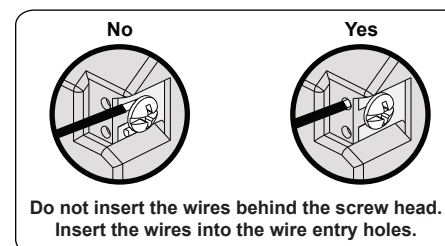

- Push all power wires back into the electrical box and fasten the device to the electrical box with the provided screws.
- Attach the decorative faceplate.
- Ensure all of the buttons actuate without sticking.
- Restore power at the circuit breaker.

Changing the Button Assemblies

The button assembly can be removed and replaced with other button assemblies. To change a button assembly, perform the following procedure:

- Remove the button assembly by squeezing the sides of the bezel near the bezel snaps.

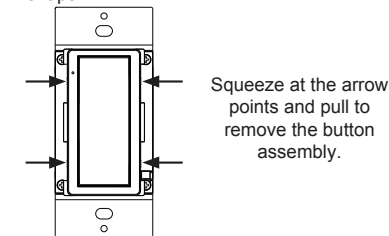

NOTE: When the button assembly is removed, power to the unit and load is removed automatically.

- Remove the button(s) from the front of the button assembly.

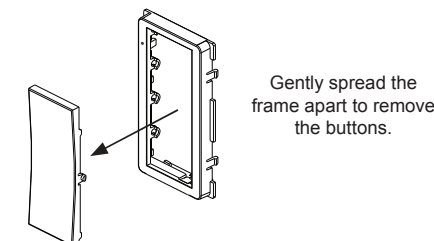

- Insert the new buttons through the front of the bezel and snap them into place. Ensure that the LED is on the left side.

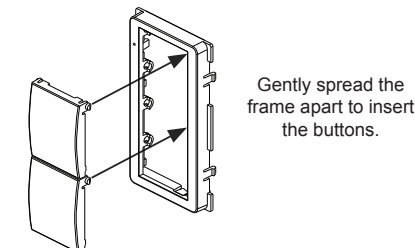

- Attach the button assembly to the device. Ensure that the LED is on the left side.

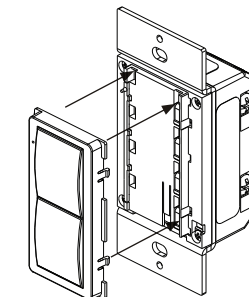

OPERATION

NOTE: The device may be warm to the touch during operation. This is normal.

Basic Operation

Operation described in this guide assumes the CLW-SWEX-E is operating in Local mode (without the use of a control system). The CLW-SWEX-E can also operate in Remote mode, in which button behavior is dictated entirely by the control system program. The CLW-SWEX-E is shipped with a rocker switch already installed. In this configuration, the unit will function as shown below.

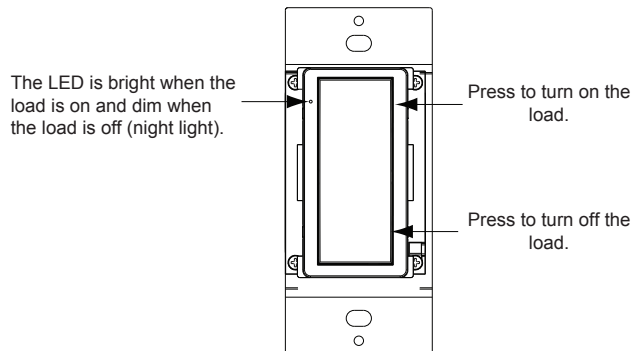

Default Button Functions

The figures below illustrate the default functions available for each button configuration and press sequence.

Single Button Press

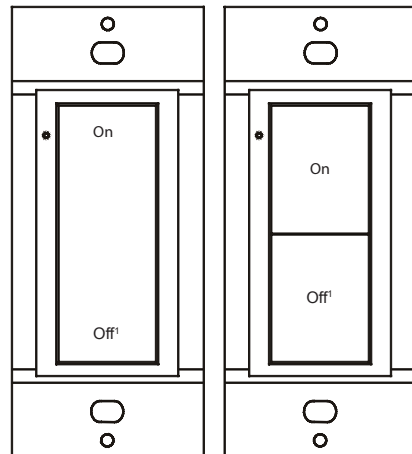

Double Button Press (Press Twice within 1/2 Second)

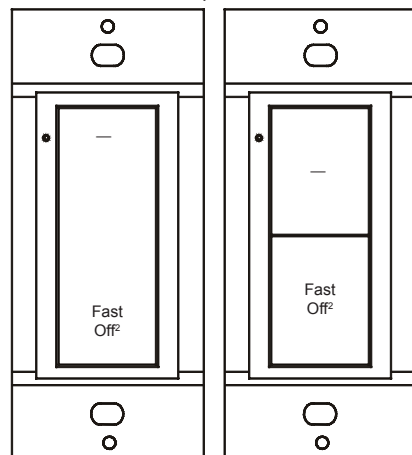

1. Delayed off can be added via control system programming.
2. Fast off functionality is only performed if a delay has been added via control system programming.

WIRELESS COMMUNICATIONS

The device connects to the Crestron network via the infiNET EX communications protocol. Use the procedures outlined below to join or leave an infiNET EX network and to verify communications between the device and the control system.

Joining an infiNET EX Network

Before a CLW-SWEX-E can be used in a lighting system, it must first join an infiNET EX network by being acquired by an infiNET EX gateway.

NOTE: A CLW-SWEX-E can be acquired by only one gateway.

- Put the infiNET EX gateway into Acquire mode from the unit itself or from Crestron Toolbox as described in its manual at www.crestron.com/manuals.

NOTE: In an environment where multiple gateways are installed, only one gateway should be in Acquire mode at any time.
- Place the CLW-SWEX-E into Acquire mode.
 - Tap the top button three times, and then press and hold it down (tap-tap-tap-press+hold) until the LED starts to blink (this can take up to 10 seconds).
 - Release the button to start the acquire process. The top LED blinks slowly to show that the device is actively scanning the infiNET EX network.
 - The LED lights for 5 seconds when the device has been successfully acquired to the infiNET EX network.
 - The LED blinks rapidly to indicate that the device was not successfully acquired by the infiNET EX network. Press the top button to acknowledge failure to acquire the infiNET EX network. Ensure gateway is in Acquire mode and within range before attempting the acquire process again.
- Once all devices have been acquired, take the gateway out of Acquire mode. Refer to the gateway's operations guide for more information.

Leaving an infiNET EX Network

To leave an infiNET EX network, put the CLW-SWEX-E into Acquire mode, as described in "Joining an infiNET EX Network" above, when no gateway is in Acquire mode.

Verifying Communications Status

To check the communications status of the CLW-SWEX-E, tap the top button three times and then press and hold it down (tap-tap-tap-press+hold) for less than 2 seconds. The LED blinks to indicate the communications status. Refer to the following table for details.

LED	COMMUNICATIONS STATUS
Turns on for 5 seconds	Device is communicating with the control system.
Blinks three times	Device is communicating with the gateway but the gateway is not communicating with the control system.
Blinks twice	Device was previously joined to the network but is not communicating with the gateway.
Blinks once	Device is not joined to the network.

TROUBLESHOOTING

The following table provides corrective action for possible trouble situations. If further assistance is required, please contact a Crestron customer service representative.

CLW-SWEX-E Troubleshooting

TROUBLE	POSSIBLE CAUSES	CORRECTIVE ACTION
The switch does not function.	The switch is not receiving line power.	Verify that the switch is properly connected to the power line and that the circuit breaker is closed.
	The load is not operational (e.g., the lamps are burned out).	Verify that the load is operational.
	The device is in Remote mode.	Check the SIMPL program to determine or change the operating mode.
	The switch is not connected to neutral.	Add a connection to a neutral wire.

Product warranty can be found at www.crestron.com/warranty.

The specific patents that cover Crestron products are listed at patents.crestron.com.

Crestron, the Crestron logo, Cameo, Crestron Toolbox, and infiNET EX are either trademarks or registered trademarks of Crestron Electronics, Inc. in the United States and/or other countries. UL and the UL logo are either trademarks or registered trademarks of Underwriters Laboratories, Inc. in the United States and/or other countries. Other trademarks, registered trademarks, and trade names may be used in this document to refer to either the entities claiming the marks and names or their products. Crestron disclaims any proprietary interest in the marks and names of others. *Crestron is not responsible for errors in typography or photography.*

This document was written by the Technical Publications department at Crestron.
©2015 Crestron Electronics, Inc.