

## 45-Degree Angled Connectors and Termination Tool for DigitalMedia™ Ultra Cables

This guide explains how to use the DM-CONN-ULTRA-RECP-XA-20 Connectors with the DM-CRIMP-ULTRA-RECP-XA Termination Tool, both sold separately.

The Crestron® [DM-CONN-ULTRA-RECP-XA-20](#) is a shielded CAT6a RJ-45 jack designed for use with the [DM-CONN-ULTRA-PLUG-20](#) Connectors (sold separately) for DigitalMedia™ cables ([DM-CBL-8G](#) and [DM-CBL-ULTRA](#), sold separately). The 45-degree angle termination allows cables to exit the outlet in two different directions. The termination also allows cables to enter raceways or back boxes from the side, top, or bottom.

The termination tool ([DM-CRIMP-ULTRA-RECP-XA](#)) is required to terminate the DM-CONN-ULTRA-RECP-XA-20.

The DM-CONN-ULTRA-RECP-XA-20 ships in packs of 20. Each pack includes a receptacle body, a cover, a tie-wrap, and the termination module to be used with the termination tool.

For simplicity in this guide, the receptacle is referred to as the DM-CONN-ULTRA-RECP-XA.

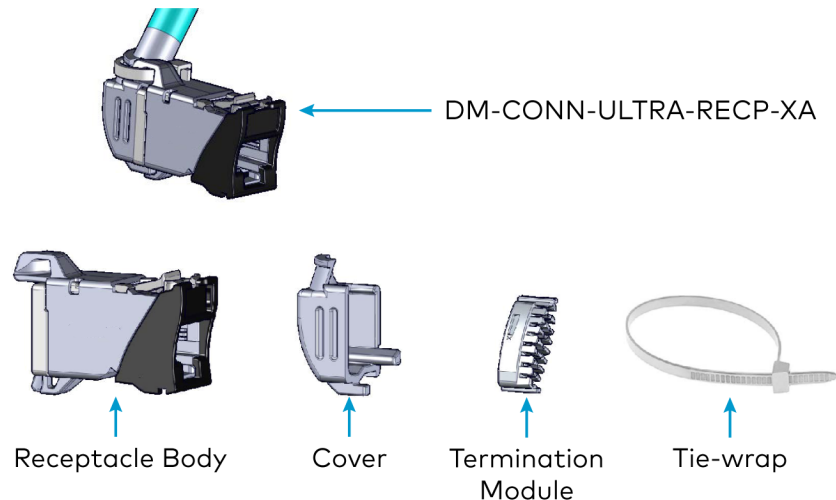

## Prepare the Cable for Termination

Flush cutters, a flat screwdriver, a jacket stripper, and the termination tool (DM-CRIMP-ULTRA-RECP-XA) are not included and are required for cable termination.

### Prepare DM-CBL-8G Cable

**CAUTION:** Do not nick the foil shield or the insulation of the wires.

1. Strip the outer jacket of the cable about 2 in. from the end of the cable.

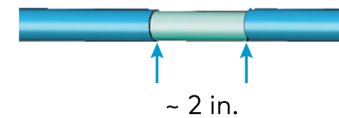

2. Fold back the foil so that it lies over the cable jacket.



3. Fold back the drain wire and wrap it around the foil shield.

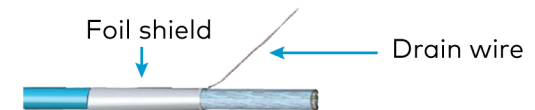

## 45-Degree Angled Connectors and Termination Tool for DigitalMedia™ Ultra Cables

- Using flush cutters, remove the mylar wrap.



- Gently spread the four twisted pairs to expose the center spline.

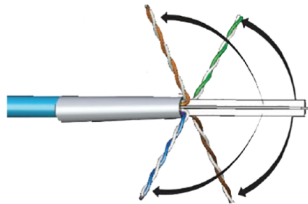

- Remove the center spline.

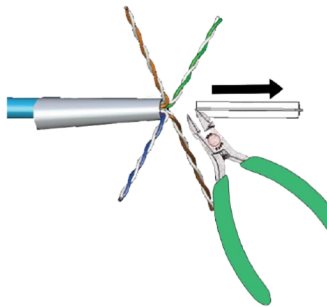

### Prepare the DM-CBL-ULTRA Cable

**CAUTION:** Do not nick the braid shield or the insulation of the wires.

- Strip the outer jacket of the cable about 2 in. from the end of the cable.



- Carefully pull the braid shield away from the cable.

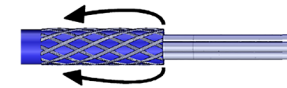

- Twist the braid shield together creating a drain wire.

- Trim the individual cable pair foils close to the cable jacket, being careful not to damage the created drain wire.

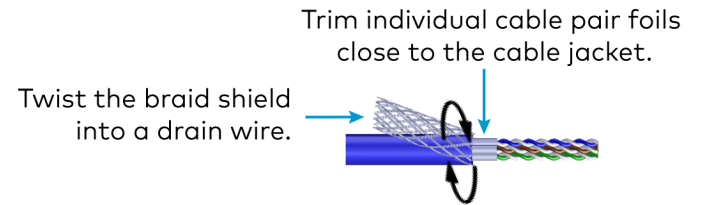

## 45-Degree Angled Connectors and Termination Tool for DigitalMedia™ Ultra Cables



### Prepare the Termination Tool

Insert the termination module into the DM-CRIMP-ULTRA-RECP-XA termination tool.

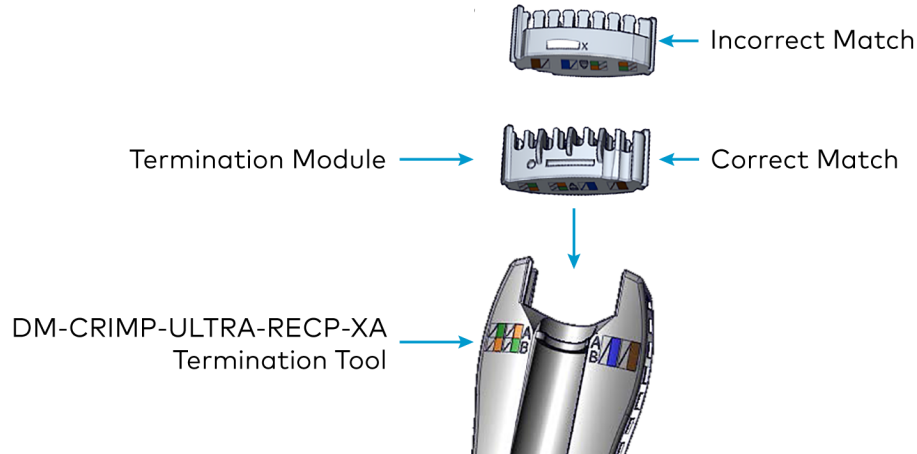

### Attach the Wires to the Termination Module

1. Gently spread the twisted pairs according to the scheme being used.

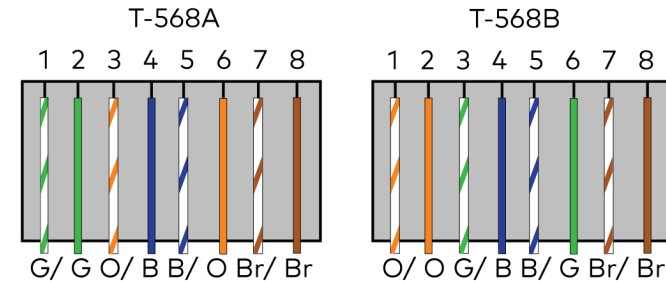

2. Place the cable onto the DM-CRIMP-ULTRA-RECP-XA termination tool to stabilize it.



3. Insert the wires of the DM-CBL-8G or the DM-CBL-ULTRA into the termination module, following the guide printed on the tool for correct wire placement.

## 45-Degree Angled Connectors and Termination Tool for DigitalMedia™ Ultra Cables

4. Straighten and arrange the four twisted pairs according to the color scheme on the termination module. Untwist each wire just enough to insert each wire into the appropriate channel of the termination module.

Arrange the wires according to the color scheme on the termination module.

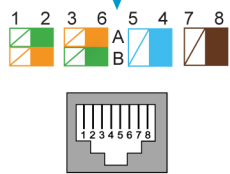

Untwist each wire pair just enough to insert into the appropriate channel.

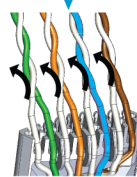

Ensure the twisted pairs are straightened.

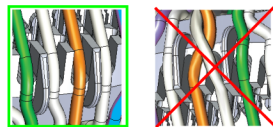

5. Remove the termination module with the cable from the DM-CRIMP-ULTRA-RECP-XA termination tool.
6. Fully seat each wire into the appropriate channel. Ensure that each wire lies below the top surface of the termination module as indicated by the dashed line in the illustration below.

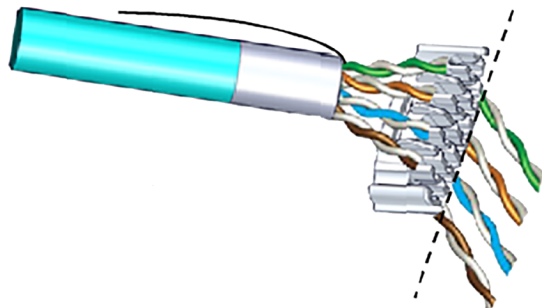

7. Using flush cutters, cut the wires flush with the edge of the channels.
8. Trim the excess DM-CBL-ULTRA braid shield or the excess DM-CBL-8G drain wire and foil shield.

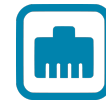

## Terminate the Cable

1. Insert the DM-CONN-ULTRA-RECP-XA into the DM-CRIMP-ULTRA-RECP-XA termination tool.
2. Position the cable into the DM-CONN-ULTRA-RECP-XA. Ensure the notches match for proper orientation.

DM-CONN-ULTRA-RECP-XA

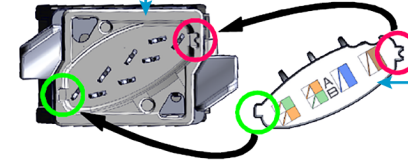

DM-CBL-8G or DM-CBL-ULTRA Cable with Termination Module

3. Press the DM-CONN-ULTRA-RECP-XA down to fully seat it to the base of the DM-CRIMP-ULTRA-RECP-XA termination tool, then press the handle to terminate the DM-CONN-ULTRA-RECP-XA.
4. Remove the terminated cable from the DM-CRIMP-ULTRA-RECP-XA, and orient the cable as necessary.

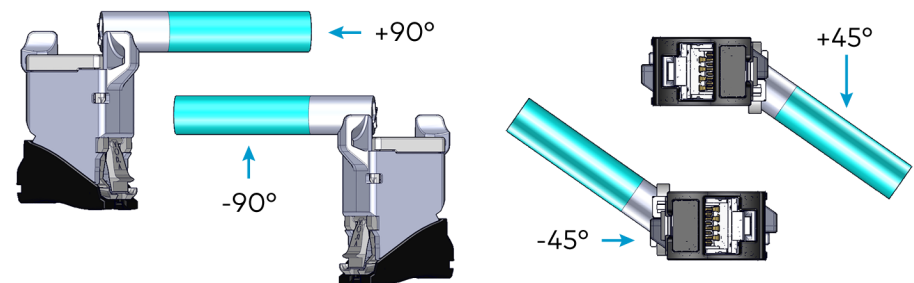

## 45-Degree Angled Connectors and Termination Tool for DigitalMedia™ Ultra Cables

5. Attach the cover to the back of the DM-CONN-ULTRA-RECP-XA.

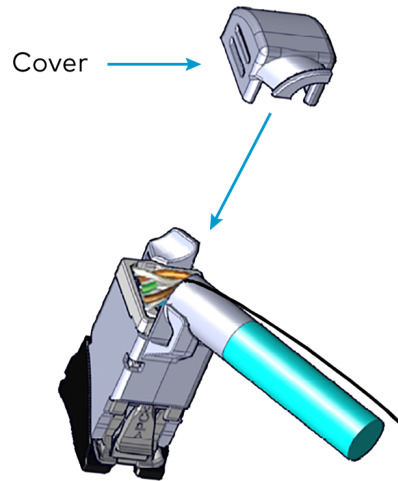

### Install the Cable

To mount the DM-CONN-ULTRA-RECP-XA to the rear of a keystone module, tilt and press the receptacle into place.

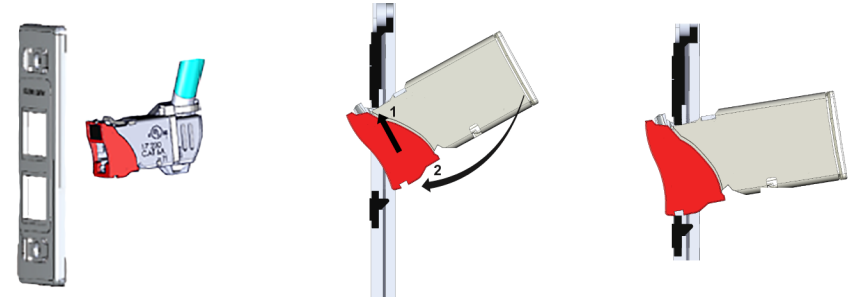

6. Wrap the drain wire around the DM-CONN-ULTRA-RECP-XA, and secure in place with a tie-wrap.

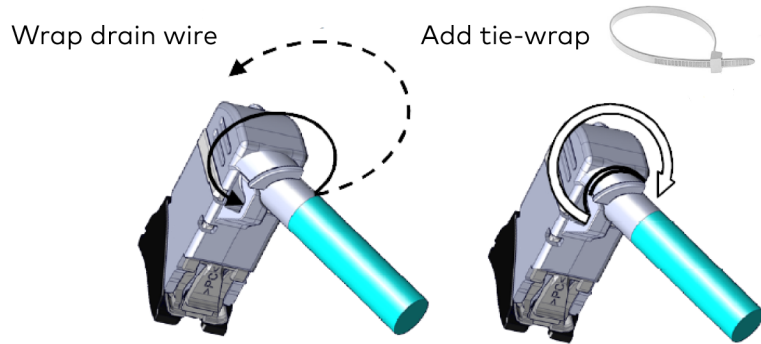

## 45-Degree Angled Connectors and Termination Tool for DigitalMedia™ Ultra Cables



### Dismantle the DM-CONN-ULTRA-RECP-XA

Pliers, a flat screwdriver (both not included), and the DM-CRIMP-ULTRA-RECP-XA are required for removal.

1. Cut the tie-wrap with the pliers, pull the cover off of the DM-CONN-ULTRA-RECP-XA, and straighten the cable.

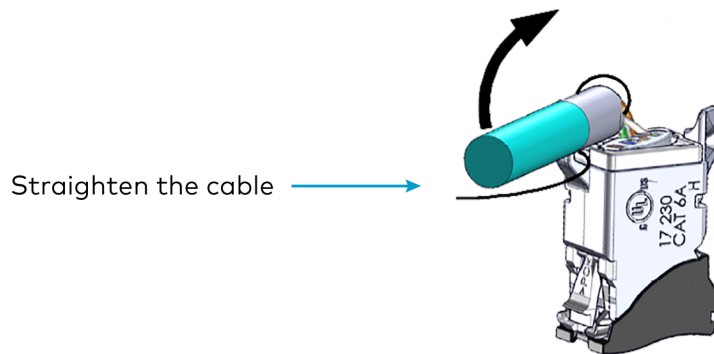

2. By hand or using the DM-CRIMP-ULTRA-RECP-XA termination tool, pull the cable from the DM-CONN-ULTRA-RECP-XA.

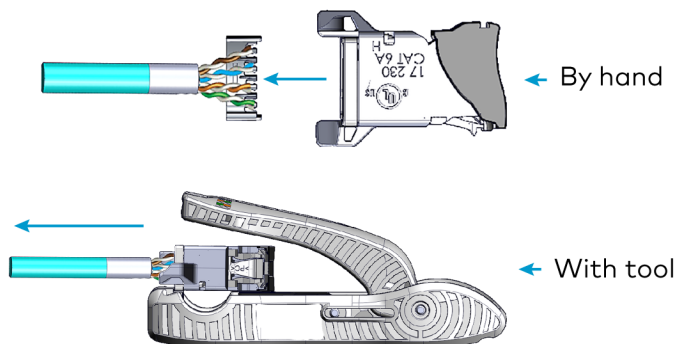

### Visit the Product Page

Scan the QR code to visit the product page.

#### DM-CONN-ULTRA-RECP-XA-20



[www.crestron.com/model/6511277](http://www.crestron.com/model/6511277)

#### DM-CRIMP-ULTRA-RECP-XA (Termination Tool)



[www.crestron.com/model/6511279](http://www.crestron.com/model/6511279)

## 45-Degree Angled Connectors and Termination Tool for DigitalMedia™ Ultra Cables

### Additional Information

#### Original Instructions

The U.S. English version of this document is the original instructions. All other languages are a translation of the original instructions.

Crestron product development software is licensed to Crestron dealers and Crestron Service Providers (CSPs) under a limited nonexclusive, nontransferable Software Development Tools License Agreement. Crestron product operating system software is licensed to Crestron dealers, CSPs, and end-users under a separate End-User License Agreement. Both of these Agreements can be found on the Crestron website at [www.crestron.com/legal/software\\_license\\_agreement](http://www.crestron.com/legal/software_license_agreement).

The product warranty can be found at [www.crestron.com/warranty](http://www.crestron.com/warranty).

The specific patents that cover Crestron products are listed at [www.crestron.com/legal/patents](http://www.crestron.com/legal/patents).

Certain Crestron products contain open source software. For specific information, visit [www.crestron.com/opensource](http://www.crestron.com/opensource).

Crestron, the Crestron logo, and DigitalMedia are either trademarks or registered trademarks of Crestron Electronics, Inc. in the United States and/or other countries. Other trademarks, registered trademarks, and trade names may be used in this document to refer to either the entities claiming the marks and names or their products. Crestron disclaims any proprietary interest in the marks and names of others. Crestron is not responsible for errors in typography or photography.

©2020 Crestron Electronics, Inc.

Doc. 8752B

11/23/20