

**TRaC Radio Test Report** : TRA-014725WUS2a

**Applicant** : Telegesis (UK) Ltd

**Apparatus** : ETRX358x-LRS and ETRX358xHR-LRS radio modules

**Specification(s)** : CFR47 Part 15.247

**FCCID** :S4GEM358L

**Purpose of Test** : Certification

**Authorised by** : 

: Radio Product Manager

**Issue Date** :8<sup>th</sup> May 2014

**Authorised Copy Number** : PDF

**Contents**

Section 1: Introduction	3
1.1 General	3
1.2 Tests Requested By	4
1.3 Manufacturer	4
1.4 Apparatus Assessed	5
1.5 Test Result Summary	6
1.6 Notes Relating To The Assessment	7
1.7 Deviations from Test Standards	7
Section 2: Measurement Uncertainty	8
2.1 Measurement Uncertainty Values	8
Section 3: Modifications	9
3.1 Modifications Performed During Assessment	9
Appendix A: Test Results	10
A1 6 dB Bandwidth	11
A2 Transmitter Peak Output Power	12
A3 Transmitter Power Spectral Density	14
A4 RF Antenna Conducted Spurious Emissions	15
A5 Antenna Gain	18
A6 Radiated Electric Field Emissions within the Restricted Bands of 15.205	19
A7 Unintentional Radiated Spurious Emissions	27
Appendix B: Supporting Graphical Data	28
Appendix C: Additional Test and Sample Details	87
Appendix D: Additional Information	93
Appendix E: Photographs and Figures	113
Appendix F: MPE Calculation	120
Appendix G: IC Declaration	121

**Section 1:****Introduction****1.1 General**

This report contains an assessment of an apparatus against Electromagnetic Compatibility Standards based upon tests carried out on samples submitted to the Laboratory.

Test performed at: TRaC [ X ]  
Unit E  
South Orbital Trading Park  
Hedon Road  
Hull, HU9 1NJ.  
United Kingdom.

Telephone: +44 (0) 1482 801801  
Fax: +44 (0) 1482 801806

TRaC [ ]  
Moss View  
Nipe Lane  
Up Holland  
West Lancashire, WN8 9PY  
United Kingdom

Telephone: +44 (0) 1695 556666  
Fax: +44 (0) 1695 577077

Email: [test@tracglobal.com](mailto:test@tracglobal.com)  
Web site: <http://www.tracglobal.com>

Tests performed by: A Longley

Report author: A Longley

**This report must not be reproduced except in full without prior written permission from TRaC Global Ltd.**

## **1.2 Tests Requested By**

This testing in this report was requested by:

Telegesis (UK) Ltd  
1 Abbey Barn Business Centre  
Abbey Barn Lane  
High Wycombe  
Bucks  
HP10 9QQ  
United Kingdom

## **1.3 Manufacturer**

As above

#### 1.4 Apparatus Assessed

The following apparatus was assessed between: 18/10/13 and 13/02/14

ETRX358x-LRS and ETRX358xHR-LRS radio modules

Radiated testing was performed using 3 antenna types (chip, quarter-wave and half-wave), conducted tests were performed on a sample with a coaxial cable fitted to the antenna terminal.

The ETRX358x-LRS series consists of:

ETRX3581-LRS  
ETRX3582-LRS  
ETRX3585-LRS  
ETRX3586-LRS  
ETRX3587-LRS  
ETRX3588-LRS

The ETRX3587-LRS module was selected as worst case by initial measurements.

The ETRX358xHR-LRS series consists of:

ETRX3581HR-LRS  
ETRX3582HR-LRS  
ETRX3585HR-LRS  
ETRX3586HR-LRS  
ETRX3587HR-LRS  
ETRX3588HR-LRS

The ETRX3587HR-LRS module was selected as worst case by initial measurements.

## 1.5 Test Result Summary

Full details of test results are contained within Appendices A. The following table summarises the results of the assessment.

The statements relating to compliance with the standards below apply ONLY as qualified in the notes and deviations stated in sections 1.6 to 1.7 of this test report.

Test Type	Regulation	Measurement standard	Result
Radiated spurious emissions (Restricted bands)	Title 47 of the CFR: Part 15 Subpart C; 15.247	ANSI C63.10	Pass
Conducted spurious emissions (Non-restricted bands)	Title 47 of the CFR: Part 15 Subpart C; 15.247	ANSI C63.10	Pass
Occupied Bandwidth	Title 47 of the CFR : Part 15 Subpart C; 15.247(a)(2)	ANSI C63.10	Pass
Conducted Carrier Power	Title 47 of the CFR : Part 15 Subpart C; 15.247(b)	ANSI C63.10	Pass
Power Spectral Density	Title 47 of the CFR : Part 15 Subpart C; 15.247(d)	ANSI C63.10	Pass
Unintentional Radiated Spurious Emissions	Title 47 of the CFR: Part 15 Subpart C; 15.109	ANSI C63.10	Pass
RF Safety	Title 47 of the CFR : Part 15 Subpart C; 15.247(b)(5)	-	Pass

Abbreviations used in the above table:

Mod	: Modification	ANSI	: American National Standards Institution
CFR	: Code of Federal Regulations	PLCE	: Power Line Conducted Emissions
REFE	: Radiated Electric Field Emissions		

## 1.6 Notes Relating To The Assessment

With regard to this assessment, the following points should be noted:

The results contained in this report relate only to the items tested and were obtained in the period between the date of initial receipt of samples and the date of issue of the report.

The apparatus was set up and exercised using the configurations, modes of operation and arrangements defined in this report only.

Particular operating modes, apparatus monitoring methods and performance criteria required by the standards tested to have been performed except where identified in Section 1.7 of this test report (Deviations from Test Standards).

For emissions testing, throughout this test report, "Pass" indicates that the results for the sample as tested were below the specified limit (refer also to Section 2, Measurement Uncertainty).

Where relevant, the apparatus was only assessed using the monitoring methods and susceptibility criteria defined in this report.

All testing with the exception of testing at the Open Area Test Site was performed under the following environmental conditions:

Temperature	: 17 to 23 °C
Humidity	: 45 to 75 %
Barometric Pressure	: 86 to 106 kPa

All dates used in this report are in the format dd/mm/yy.

This assessment has been performed in accordance with the requirements of ISO/IEC 17025.

## 1.7 Deviations from Test Standards

There were no deviations from the standards tested to.

**Section 2:****Measurement Uncertainty****2.1 Measurement Uncertainty Values**

## Radiated Electric Field Emissions

Quantity Range	Quantity	Expanded Uncertainty
9kHz to 150 kHz	Amplitude dB( $\mu$ V/m)	$\pm 1.6$ dB
150 kHz to 30 MHz	Amplitude dB( $\mu$ V/m)	$\pm 2.1$ dB
30MHz to 300MHz Horizontal	Amplitude dB( $\mu$ V/m)	$\pm 5.1$ dB
30MHz to 300MHz Vertical	Amplitude dB( $\mu$ V/m)	$\pm 5.2$ dB
300MHz to 1GHz Horizontal	Amplitude dB( $\mu$ V/m)	$\pm 5.4$ dB
300MHz to 1GHz Vertical	Amplitude dB( $\mu$ V/m)	$\pm 5.2$ dB
1GHz to 18GHz Horizontal	Amplitude dB( $\mu$ V/m)	$\pm 4.4$ dB
1GHz to 18GHz Vertical	Amplitude dB( $\mu$ V/m)	$\pm 4.4$ dB
18GHz to 26.5GHz Horizontal	Amplitude dB( $\mu$ V/m)	$\pm 4.2$ dB
18GHz to 26.5GHz Vertical	Amplitude dB( $\mu$ V/m)	$\pm 4.2$ dB
26.5GHz to 40GHz Horizontal	Amplitude dB( $\mu$ V/m)	$\pm 4.3$ dB
26.5GHz to 40GHz Vertical	Amplitude dB( $\mu$ V/m)	$\pm 4.3$ dB

## Power Line Conducted Emissions

Quantity Range	Quantity	Expanded Uncertainty
9kHz to 150kHz	Amplitude dB( $\mu$ V)	$\pm 4.2$ dB
150kHz to 30MHz	Amplitude dB( $\mu$ V)	$\pm 3.1$ dB



**Section 3:**

**Modifications**

**3.1 Modifications Performed During Assessment**

No modifications were performed during the assessment

**Appendix A:****Test Results**

Abbreviations used in the tables in this appendix:

Spec	: Specification	ALSR	: Absorber Lined Screened Room
Mod	: Modification	OATS	: Open Area Test Site
EUT	: Equipment Under Test	ATS	: Alternative Test Site
SE	: Support Equipment	Ref	: Reference
L	: Live Power Line	Freq	: Frequency
N	: Neutral Power Line	MD	: Measurement Distance
E	: Earth Power Line	SD	: Spec Distance
Pk	: Peak Detector	Pol	: Polarisation
QP	: Quasi-Peak Detector	H	: Horizontal Polarisation
Av	: Average Detector	V	: Vertical Polarisation
CDN	: Coupling & decoupling network		

**A1 6 dB Bandwidth**

Title 47 of the CFR: Part 15 Subpart (c) 15.247(a)(2) requires the measurement of the bandwidth of the transmission between the -6 dB points on the transmitted spectrum.

Test Details:	
Regulation	Title 47 of the CFR: Part 15 Subpart (c) 15.247(a)(2)
EUT sample number	S30
Modification state	0
SE in test environment	S38
SE isolated from EUT	TRaC Laptop
EUT set up	Refer to Appendix C

## Antenna Port

Channel Frequency (MHz)	Transmit Power Setting (dBm)	Measured 6 dB Bandwidth (MHz)	Limit (kHz)	Result
2405	-7	1.643	>500	Pass
2445	-7	1.618	>500	Pass
2475	-7	1.624	>500	Pass
2480	-15	1.632	>500	Pass

Plots of the 6 dB bandwidth are contained in Appendix B of this test report.

**A2 Transmitter Peak Output Power**

Carrier power was verified with the EUT transmitting on its lowest, centre and highest carrier frequency in turn.

<b>Test Details:</b>	
Regulation	Title 47 of the CFR: Part15 Subpart (c) 15.247(b)(3)
Measurement standard	ANSI C63.10
EUT sample number	S36 (Chip Antenna) S30 with S21 (Quarter-wave Antenna) S30 with S17 (Half-wave Antenna)
Modification state	0
SE in test environment	S38
SE isolated from EUT	TRaC Laptop
EUT set up	Refer to Appendix C

Chip Antenna:

Channel Frequency (MHz)	Peak Carrier Power (W)	Antenna Gain dBi	Radiated Power (W) (EIRP)	Limit (W)	Result
2405	0.07621	2.1	0.12359	1.0000	Pass
2445	0.09683	2.1	0.15704	1.0000	Pass
2475	0.08650	2.1	0.14028	1.0000	Pass
2480	0.00102	2.1	0.00166	1.0000	Pass

Quarter-wave Antenna:

Channel Frequency (MHz)	Peak Carrier Power (W)	Antenna Gain dBi	Radiated Power (W) (EIRP)	Limit (W)	Result
2405	0.07621	0	0.07621	1.0000	Pass
2445	0.09683	0	0.09683	1.0000	Pass
2475	0.08650	0	0.08650	1.0000	Pass
2480	0.00102	0	0.00102	1.0000	Pass

Half-wave Antenna:

Channel Frequency (MHz)	Peak Carrier Power (W)	Antenna Gain dBi	Radiated Power (W) (EIRP)	Limit (W)	Result
2405	0.07621	2.0	0.12078	1.0000	Pass
2445	0.09683	2.0	0.15346	1.0000	Pass
2475	0.08650	2.0	0.13709	1.0000	Pass
2480	0.00102	2.0	0.00162	1.0000	Pass

**Notes:**

Conducted Measurement

Measured Peak Carrier power includes the gain of each of the antennas.

Highest Gain of any antenna to be used = 2.1 dBi

Conducted measurements were performed with a direct cable connection to the antenna port on the board.

An EUT power setting of -7 was used with the following exceptions

- for the 2480MHz channel a -15 power setting was used.

**A3 Transmitter Power Spectral Density**

Transmitter Power Spectral Density was verified with the EUT transmitting on its lowest, centre and highest carrier frequency in turn.

<b>Test Details:</b>	
Regulation	Title 47 of the CFR: Part15 Subpart (c) 15.247(e)
Measurement standard	ANSI C63.10
EUT sample number	S30
Modification state	0
SE in test environment	S38
SE isolated from EUT	TRaC Laptop
EUT set up	Refer to Appendix C

Antenna Port:

<b>Channel Frequency (MHz)</b>	<b>Transmit Power Setting (dBm)</b>	<b>Peak Power Spectral Density (dBm/3kHz)</b>	<b>Limit (dBm/3kHz)</b>	<b>Result</b>
2405	-7	6.9	8.0	Pass
2445	-7	7.3	8.0	Pass
2475	-7	7.5	8.0	Pass
2480	-15	-9.5	8.0	Pass

**Notes:**

Conducted Measurement

Measured Power Spectral Density includes highest gain of any antenna to be used.

Highest Gain of any antenna to be used = 2.1 dBi

Conducted measurements were performed with a direct cable connection to the EUT antenna port.

The resolution bandwidth on the analyser was set to 3kHz and trace set to max hold.

The span was set to 2 MHz

The sweep time was 670 seconds (Span/3kHz).

An EUT power setting of -7dBm was used with the following exception

- for the 2480MHz channel a -15dBm power setting was used.

**A4 RF Antenna Conducted Spurious Emissions**

Measurement of conducted spurious emissions at the antenna port was performed using a peak detector with the RBW set to 100kHz and the VBW>RBW. Frequencies were scanned up through to the 10th harmonic with the EUT transmitting on its lowest, centre and highest carrier frequency in turn.

<b>Test Details: 2405MHz</b>	
Regulation	Title 47 of the CFR: Part 15 Subpart (c) Clause 15.247(d) and Clause 15.205
Measurement standard	ANSI C63.10
Frequency range	9 kHz to 25 GHz
EUT sample number	S30
Modification state	0
SE in test environment	S38
SE isolated from EUT	TRaC Laptop
EUT set up	Refer to Appendix C

No emissions were detected within 20 dB of the test limit from the antenna port.

<b>Test Details: 2445MHz</b>	
Regulation	Title 47 of the CFR: Part 15 Subpart (c) Clause 15.247(d) and Clause 15.205
Measurement standard	ANSI C63.10
Frequency range	9 kHz to 25 GHz
EUT sample number	S30
Modification state	0
SE in test environment	S38
SE isolated from EUT	TRaC Laptop
EUT set up	Refer to Appendix C

No emissions were detected within 20 dB of the test limit from either antenna port.

**RF Antenna Conducted Spurious Emissions continued:**

Test Details: 2480MHz	
Regulation	Title 47 of the CFR: Part 15 Subpart (c) Clause 15.247(d) and Clause 15.205
Measurement standard	ANSI C63.10
Frequency range	9 kHz to 25 GHz
EUT sample number	S30
Modification state	0
SE in test environment	S38
SE isolated from EUT	TRaC Laptop
EUT set up	Refer to Appendix C

No emissions were detected within 20 dB of the test limit from either antenna port.

**Notes:**

1. The conducted emission limit for emissions outside the restricted bands, defined in 47CFR15.205(a) are based on a transmitted carrier level of 15.247(b). With the EUT transmitting on its lowest, centre and highest carrier frequencies in turn, emissions from the EUT are required to be 20 dB below the level of the highest fundamental as measured within a 100 kHz RBW in accordance with 15.247(d) using a peak detector.
2. The RBW = 100 kHz, Video bandwidth (VBW) > RBW and the radio spectrum was investigated up to the 10th harmonic in accordance 15.33 (a)(1).
3. The measurements at 2400 MHz and 2483.5 MHz were made to ensure band edge compliance.
4. The carrier level was measured whilst varying the supply voltage between 85% and 105% of the nominal supply voltage as required by 15.31(e). No variation in carrier level was observed. All other emissions were at least 20dB below the test limit

An EUT power setting of -7dBm was used with the following exception

- for the 2480MHz channel a -15dBm power setting was used.

The limit outside the restricted band in 100 kHz RBW is defined using the following formula in accordance with 15.247(d):

The limit in 100 kHz RBW = (Maximum Peak Conducted Carrier measured in 100kHz RBW)-20dB

Where:

The maximum peak conducted power was measured using a spectrum analyser using a 100kHz resolution bandwidth.



Antenna Port:

Channel No.	Channel Frequency (MHz)	Measured Peak Carrier (dBm)	Measured Peak Carrier -20dB (dBm)	Emission Limit In a 100 kHz RBW (dBm)
11	2405	15.84	-4.16	-4.16
19	2445	16.43	-3.57	-3.57
26	2480	-3.29	-23.29	-23.29

## **A5 Antenna Gain**

The maximum antenna gain for the antenna type to be used with the EUT, as declared by the client, is 2.1 dBi Peak gain for the chip antenna.

For reference the Peak Gains of the other antenna types are, 0 dBi for the Quarter-wave antenna and 2.0 dBi for the Half-wave antenna.

**A6 Radiated Electric Field Emissions within the Restricted Bands of 15.205**

Preliminary scans were performed using a peak detector with the RBW = 100kHz. The radiated electric field emission test applies to spurious emissions and harmonics that fall within the restricted bands listed in Section 15.205. The maximum permitted field strength is listed in Section 15.209. The EUT was set to transmit on its lowest, centre and highest carrier frequency.

The following test site was used for final measurements as specified by the standard tested to:

3m open area test site :       3m alternative test site :

The effect of the EUT set-up on the measurements is summarised in note (c) below.

<b>Test Details:</b>	
Regulation	Title 47 of the CFR: Part 15 Subpart (b) Clause 15.209
Measurement standard	ANSI C63.10
Frequency range	30MHz to 25 GHz
EUT sample number	S36 (Chip Antenna) S30 with S21 (Quarter-wave Antenna) S30 with S17 (Half-wave Antenna)
Modification state	0
SE in test environment	S38, TRaC Powered USB Hub
SE isolated from EUT	None
EUT set up	Refer to Appendix C

Initial preview results were obtained with all module types, the ETRX3587-LRS and ETRX3587HR-LRS modules were selected as the worst case and all remaining tests were carried out on these modules alone.

For measurements using the chip antenna an EUT power setting of -7 was used with the following exception

- for channel 26 (2480MHz) a -15 power setting was used.

For measurements using the quarter-wave antennas an EUT power setting of -8 was used with the following exception

- for channel 26 (2480MHz) a -15 power setting was used.

For measurements using the half-wave antennas an EUT power setting of -8 was used with the following exceptions

- for channel 25 (2475MHz) a -c power setting was used,
- for channel 26 (2480MHz) a -20 power setting was used.

Band Edge measurements were performed using the Delta-Marker method on the reduced power channels (25 and 26), and on the top full power channel (24).

The worst case radiated emission measurements for spurious emissions:

Chip Antenna, Channel 11:

Ref No.	FREQ. (MHz)	DETECTOR	FIELD ST'GH (dBµV/m)	Duty Cycle Fact (dB)	FIELD ST'GH (dBµV/m)	LIMIT (dBµV/m)
1.	4840.962	Pk	59.8	0	59.8	74
2.	4810.962	Av	48.4	0	48.4	54
3.	9618.000	Pk	55.2	0	55.2	74
4.	9618.000	Av	42.6	0	42.6	54

Chip Antenna, Channel 19:

Ref No.	FREQ. (MHz)	DETECTOR	FIELD ST'GH (dBµV/m)	Duty Cycle Fact (dB)	FIELD ST'GH (dBµV/m)	LIMIT (dBµV/m)
5.	4888.917	Pk	57.7	0	57.7	74
6.	4888.917	Av	46.2	0	46.2	54
7.	7333.367	Pk	63.4	0	63.4	74
8.	7333.367	Av	51.6	0	51.6	54
9.	9777.750	Pk	54.6	0	54.6	74
10.	9777.750	Av	41.6	0	41.6	54
11.	12222.167	Pk	58.3	0	58.3	74
12.	12222.167	Av	45.6	0	45.6	54

Chip Antenna, Channel 24:

Ref No.	FREQ. (MHz)	DETECTOR	FIELD ST'GH (dBµV/m)	Duty Cycle Fact (dB)	FIELD ST'GH (dBµV/m)	LIMIT (dBµV/m)
13.	4940.900	Pk	56.9	0	56.9	74
14.	4940.900	Av	45.8	0	45.8	54
15.	7411.350	Pk	63.4	0	63.4	74
16.	7411.350	Av	51.8	0	51.8	54
17.	12347.250	Pk	57.7	0	57.7	74
18.	12347.250	Av	44.5	0	44.5	54

No further Spurious emissions within 20 dB of the test limit were detected.

Preview measurements indicated that there were no emissions below 1GHz that were due to the EUT.

## Quarter-wave Antenna, Channel 11:

Ref No.	FREQ. (MHz)	DETECTOR	FIELD ST'GH (dBµV/m)	Duty Cycle Fact (dB)	FIELD ST'GH (dBµV/m)	LIMIT (dBµV/m)
19.	4810.962	Pk	59.8	0	59.8	74
20.	4810.962	Av	53.3	0	53.3	54
21.	7216.314	Pk	54.3	0	54.3	74
22.	7216.314	Av	44.9	0	44.9	54
23.	12027.420	Pk	56.4	0	56.4	74
24.	12027.420	Av	44.3	0	44.3	54

## Quarter-wave Antenna, Channel 19:

Ref No.	FREQ. (MHz)	DETECTOR	FIELD ST'GH (dBµV/m)	Duty Cycle Fact (dB)	FIELD ST'GH (dBµV/m)	LIMIT (dBµV/m)
25.	4888.879	Pk	55.7	0	55.7	74
26.	4888.879	Av	48.9	0	48.9	54

## Quarter-wave Antenna, Channel 24:

Ref No.	FREQ. (MHz)	DETECTOR	FIELD ST'GH (dBµV/m)	Duty Cycle Fact (dB)	FIELD ST'GH (dBµV/m)	LIMIT (dBµV/m)
27.	2483.500	Pk	64.1	0	64.1	74
28.	2483.500	Av	51.5	0	51.5	54
29.	4940.962	Pk	55.1	0	55.1	74
30.	4940.962	Av	47.5	0	47.5	54

No further Spurious emissions within 20 dB of the test limit were detected.

Preview measurements indicated that there were no emissions below 1GHz that were due to the EUT.

## Half-wave Antenna, Channel 11:

Ref No.	FREQ. (MHz)	DETECTOR	FIELD ST'GH (dBµV/m)	Duty Cycle Fact (dB)	FIELD ST'GH (dBµV/m)	LIMIT (dBµV/m)
31.	4810.872	Pk	59.7	0	59.7	74
32.	4810.872	Av	53.2	0	53.2	54

## Half-wave Antenna, Channel 19:

Ref No.	FREQ. (MHz)	DETECTOR	FIELD ST'GH (dBµV/m)	Duty Cycle Fact (dB)	FIELD ST'GH (dBµV/m)	LIMIT (dBµV/m)
33.	4890.962	Pk	58.0	0	58.0	74
34.	4890.962	Av	51.0	0	51.0	54
35.	9777.747	Pk	56.6	0	56.6	74
36.	9777.747	Av	46.7	0	46.7	54

## Half-wave Antenna, Channel 24:

Ref No.	FREQ. (MHz)	DETECTOR	FIELD ST'GH (dBµV/m)	Duty Cycle Fact (dB)	FIELD ST'GH (dBµV/m)	LIMIT (dBµV/m)
37.	4941.042	Pk	60.4	0	60.4	74
38.	4941.042	Av	53.5	0	53.5	54
39.	7411.394	Pk	59.6	0	59.6	74
40.	7411.394	Av	51.5	0	51.5	54
41.	9881.867	Pk	53.9	0	53.9	74
42.	9881.867	Av	43.7	0	43.7	54

No further Spurious emissions within 20 dB of the test limit were detected.

Preview measurements indicated that there were no emissions below 1GHz that were due to the EUT.

Upper Band Edge measurements on Channel 26 were performed using a power setting of -15dBm for the chip and quarter-wave antennas and -20 for the half-wave antenna.

The Upper Band Edge radiated emission measurements – Channel 26, Chip Antenna:

Ref No.	FREQ. (MHz)	DETECTOR	FIELD ST'GH (dBµV/m)	Marker Delta (dB)	FIELD ST'GH Band Edge (dBµV/m)	LIMIT (dBµV/m)
43.	2483.5	Pk	65.3	-	62.3	74
44.	2483.5	Av	51.6	-	50.0	54

The Upper Band Edge radiated emission measurements – Channel 26, Quarter-wave Antenna:

Ref No.	FREQ. (MHz)	DETECTOR	FIELD ST'GH (dBµV/m)	Marker Delta (dB)	FIELD ST'GH Band Edge (dBµV/m)	LIMIT (dBµV/m)
45.	2483.5	Pk	65.0	-	65.0	74
46.	2483.5	Av	52.2	-	52.2	54

The Upper Band Edge radiated emission measurements – Channel 26, Half-wave Antenna:

Ref No.	FREQ. (MHz)	DETECTOR	FIELD ST'GH (dBµV/m)	Marker Delta (dB)	FIELD ST'GH Band Edge (dBµV/m)	LIMIT (dBµV/m)
47.	2483.5	Pk	37.1	-	37.1	74
48.	2483.5	Av	24.5	-	24.5	54

Upper Band Edge measurements on Channel 25 were performed using a power setting of -7dBm for the chip antenna, -8 for the quarter-wave antenna and -c for the half-wave antenna.

The Upper Band Edge radiated emission measurements – Channel 25, Chip Antenna:

Ref No.	FREQ. (MHz)	DETECTOR	FIELD ST'GH (dBµV/m)	Marker Delta (dB)	FIELD ST'GH Band Edge (dBµV/m)	LIMIT (dBµV/m)
49.	2483.5	Pk	66.1	-	66.1	74
50.	2483.5	Av	51.9	-	51.9	54

The Upper Band Edge radiated emission measurements – Channel 25, Quarter-wave Antenna:

Ref No.	FREQ. (MHz)	DETECTOR	FIELD ST'GH (dBµV/m)	Marker Delta (dB)	FIELD ST'GH Band Edge (dBµV/m)	LIMIT (dBµV/m)
51.	2483.5	Pk	65.1	-	65.1	74
52.	2483.5	Av	53.3	-	53.3	54

The Upper Band Edge radiated emission measurements – Channel 25, Half-wave Antenna:

Ref No.	FREQ. (MHz)	DETECTOR	FIELD ST'GH (dBµV/m)	Marker Delta (dB)	FIELD ST'GH Band Edge (dBµV/m)	LIMIT (dBµV/m)
53.	2483.5	Pk	67.9	-	67.9	74
54.	2483.5	Av	53.7	-	53.7	54

Upper Band Edge measurements on Channel 24 were performed using a power setting of -7dBm for the chip antenna and -8 for the quarter-wave and half-wave antennas.

The Upper Band Edge radiated emission measurements – Channel 24, Chip Antenna:

Ref No.	FREQ. (MHz)	DETECTOR	FIELD ST'GH (dBµV/m)	Marker Delta (dB)	FIELD ST'GH Band Edge (dBµV/m)	LIMIT (dBµV/m)
55.	2483.5	Pk	62.3	-	62.3	74
56.	2483.5	Av	50.0	-	50.0	54

The Upper Band Edge radiated emission measurements – Channel 24, Quarter-wave Antenna:

Ref No.	FREQ. (MHz)	DETECTOR	FIELD ST'GH (dBµV/m)	Marker Delta (dB)	FIELD ST'GH Band Edge (dBµV/m)	LIMIT (dBµV/m)
57.	2483.5	Pk	64.1	-	64.1	74
58.	2483.5	Av	51.5	-	51.5	54

The Upper Band Edge radiated emission measurements – Channel 24, Half-wave Antenna:

Ref No.	FREQ. (MHz)	DETECTOR	FIELD ST'GH carrier (dBµV/m)	Marker Delta (dB)	FIELD ST'GH Calc. Band Edge (dBµV/m)	LIMIT (dBµV/m)
59.	2470	Pk	115.5	-58.2	57.3	74
60.	2470	Av	109.9	-58.2	51.7	54



**Notes:**

- 1 Any testing performed below 30 MHz was performed using a magnetic loop antenna in accordance with ANSI C63.10: section 4.5, Table 1
- 2 In accordance with 15.35(b), above 1 GHz, emissions measured using a peak detector shall not exceed a level 20 dB above the average limit.
- 3 Testing was performed with the EUT orientated in three orthogonal planes and the maximum emissions level recorded. In addition, the EUT antenna was varied within its range of motion in order to maximise emissions.
- 4 For Frequencies below 1 GHz, RBW= 100 kHz, testing was performed with CISPR16 compliant test receiver with QP detector. Above 1 GHz tests were performed using a spectrum analyser using the following settings:
 

Peak	RBW=VBW= 1MHz
Average	RBW=VBW= 1MHz

These settings as per ANSI C63.10

The upper and lower frequency of the measurement range was decided according to CFR 47 Part 15: Clause 15.33(a) and 15.33(a)(1).

Radiated emission limits (CFR 47 Part 15: Clause 15.209) for emissions falling within the restricted bands defined in 15.205(a):

Frequency of emission (MHz)	Field strength $\mu\text{V/m}$	Measurement Distance m	Field strength $\text{dB}\mu\text{V/m}$
0.009-0.490	$2400/F(\text{kHz})$	300	$67.6/F(\text{kHz})$
0.490-1.705	$24000/F(\text{kHz})$	30	$87.6/F(\text{kHz})$
1.705-30	30	30	29.5
30-88	100	3	40.0
88-216	150	3	43.5
216-960	200	3	46.0
Above 960	500	3	54.0

**Notes:**

- (a) Where results have been measured at one distance, and a signal level displayed at another, the results have been extrapolated using the following formula:

$$\text{Extrapolation (dB)} = 20 \log_{10} \left( \frac{\text{measurement distance}}{\text{specification distance}} \right)$$

The results displayed take into account applicable antenna factors and cable losses.

- (b) The levels may have been rounded for display purposes.
- (c) The following table summarises the effect of the EUT operating mode, internal configuration and arrangement of cables / samples on the measured emission levels :

	See (i)	See (ii)	See (iii)	See (iv)
Effect of EUT operating mode on emission levels		✓		
Effect of EUT internal configuration on emission levels		✓		
Effect of Position of EUT cables & samples on emission levels	✓			
(i) Parameter defined by standard and / or single possible, refer to Appendix C (ii) Parameter defined by client and / or single possible, refer to Appendix C (iii) Parameter had a negligible effect on emission levels, refer to Appendix C (iv) Worst case determined by initial measurement, refer to Appendix C				

**A7 Unintentional Radiated Spurious Emissions**

Preliminary scans were performed using a peak detector with the RBW = 100kHz. The radiated electric field emission test applies to spurious emissions and harmonics that fall within the restricted bands listed in Section 15.205. The maximum permitted field strength is listed in Section 15.209. The EUT was set to transmit on its lowest, centre and highest carrier frequency.

The following test site was used for final measurements as specified by the standard tested to:

3m open area test site :       3m alternative test site :

The effect of the EUT set-up on the measurements is summarised in note (c) below.

<b>Test Details:</b>	
Regulation	Title 47 of the CFR: Part 15 Subpart (b) Clause 15.109
Measurement standard	ANSI C63.10
Frequency range	30MHz to 25 GHz
EUT sample number	S36 (Chip Antenna) S30 with S21 (Quarter-wave Antenna) S30 with S17 (Half-wave Antenna)
Modification state	0
SE in test environment	S38, TRaC Powered USB Hub
SE isolated from EUT	None
EUT set up	Refer to Appendix C

No significant emissions were detected.

**Appendix B:**

**Supporting Graphical Data**

This appendix contains graphical data obtained during testing.

Notes:

- (a) The radiated electric field emissions and conducted emissions graphical data in this appendix is preview data. For details of formal results, refer to Appendices A, B and C.
- (b) The time and date on the plots do not necessarily equate to the time of the test.
- (c) Where relevant, on power line conducted emission plots, the limit displayed is the average limit, which is stricter than the quasi peak limit.
- (d) Appendix C details the numbering system used to identify the sample and its modification state.
- (e) The plots presented in this appendix may not be a complete record of the measurements performed, but are a representative sample, relative to the final assessment.

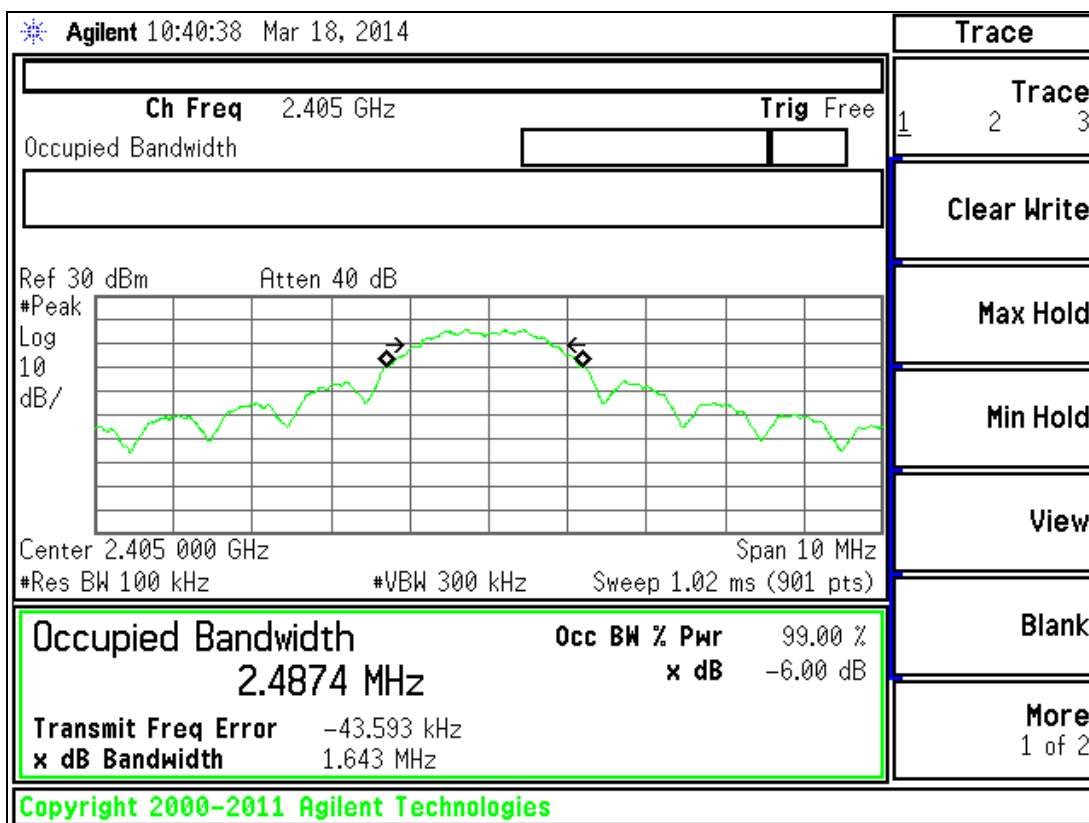

6dB Bandwidth (-7dBm) 2405 MHz

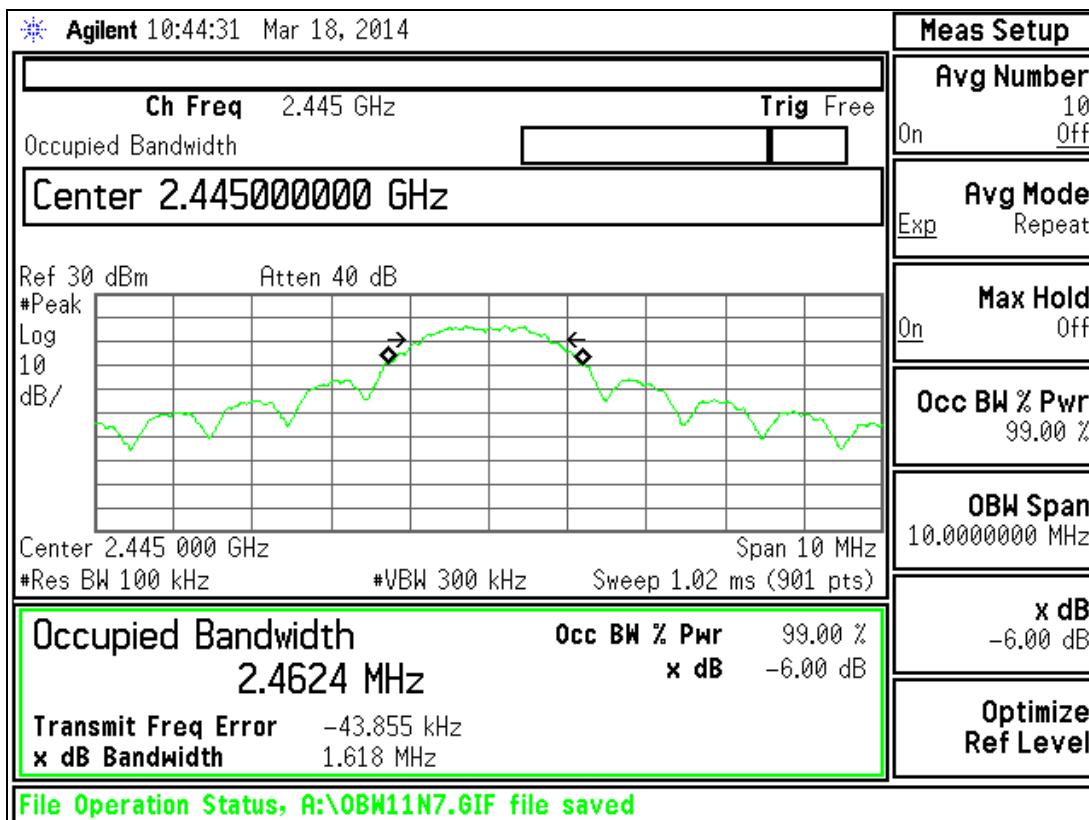

6dB Bandwidth (-7dBm) 2445 MHz

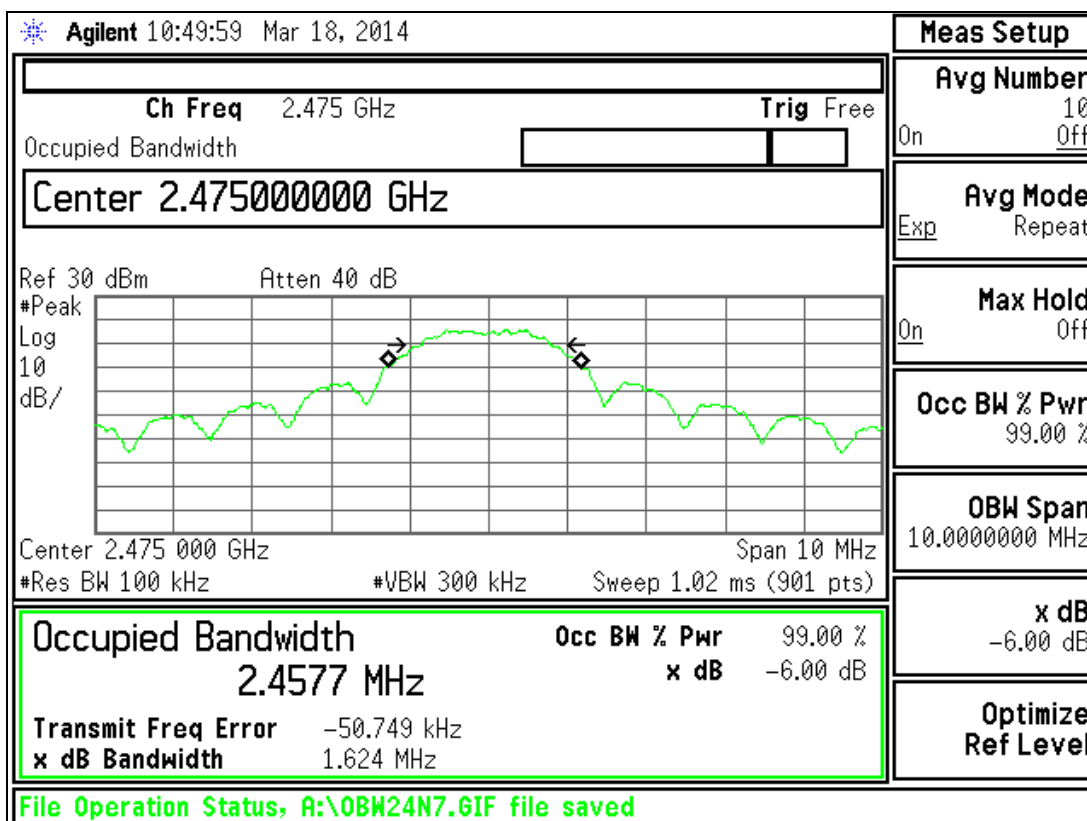

6dB Bandwidth (-7dBm) 2475 MHz

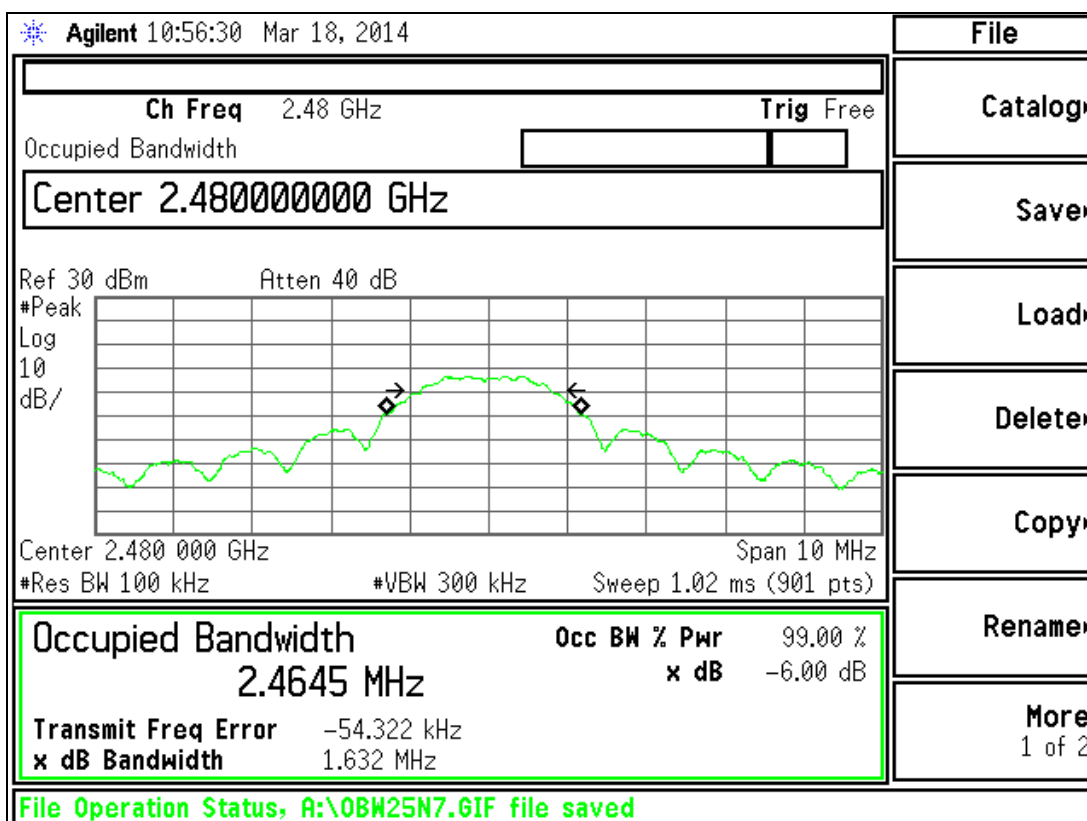

6dB Bandwidth (-15dBm) 2480 MHz

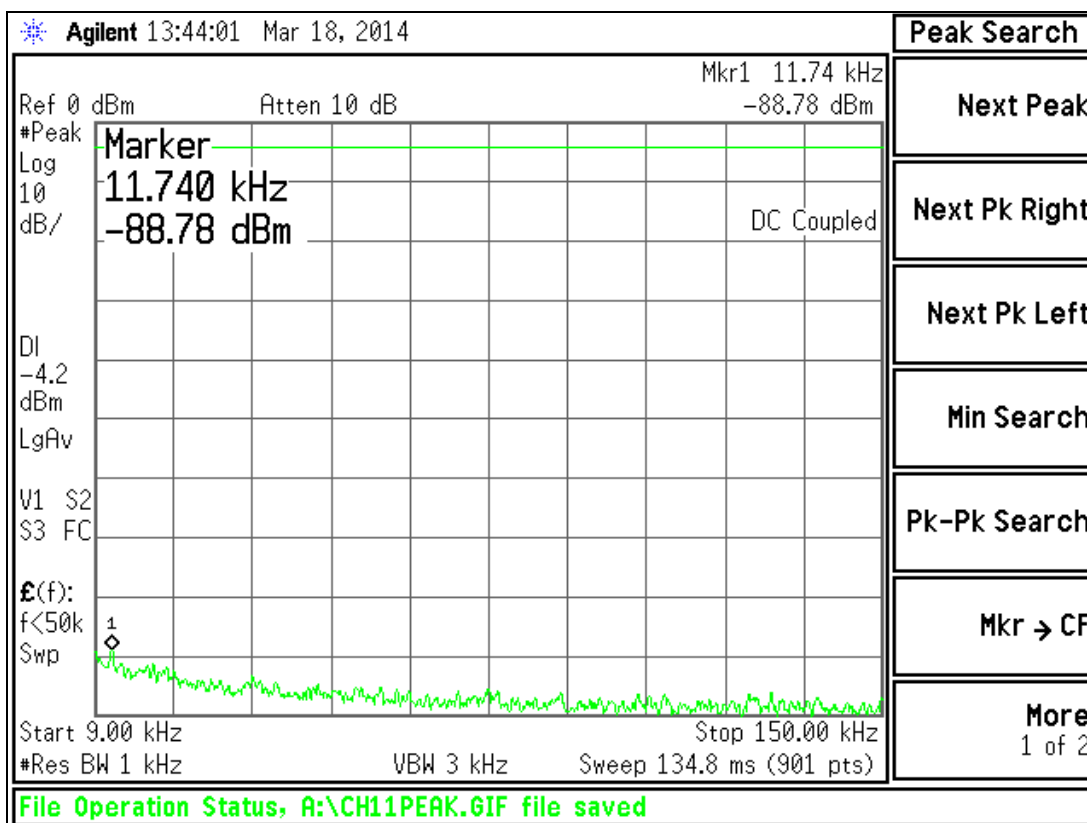

Conducted Spurious emissions 9kHz to 150 kHz – 2405 MHz

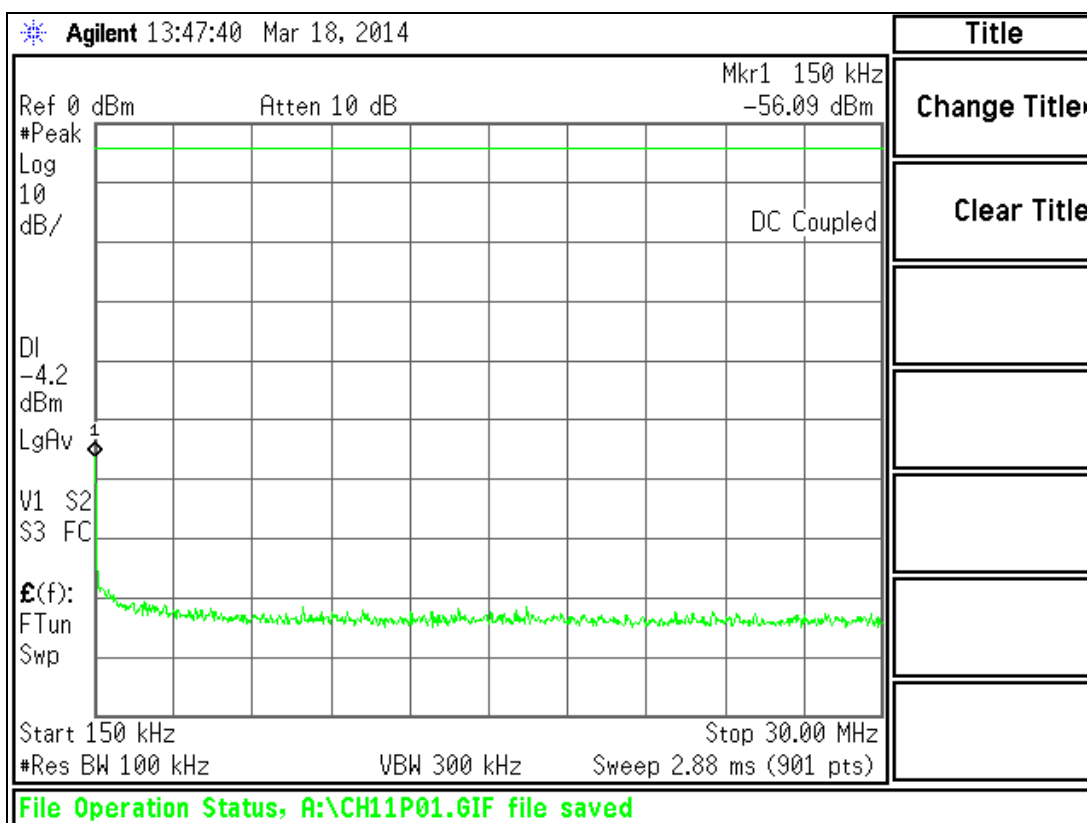

Conducted Spurious emissions 150 kHz to 30 MHz – 2405 MHz

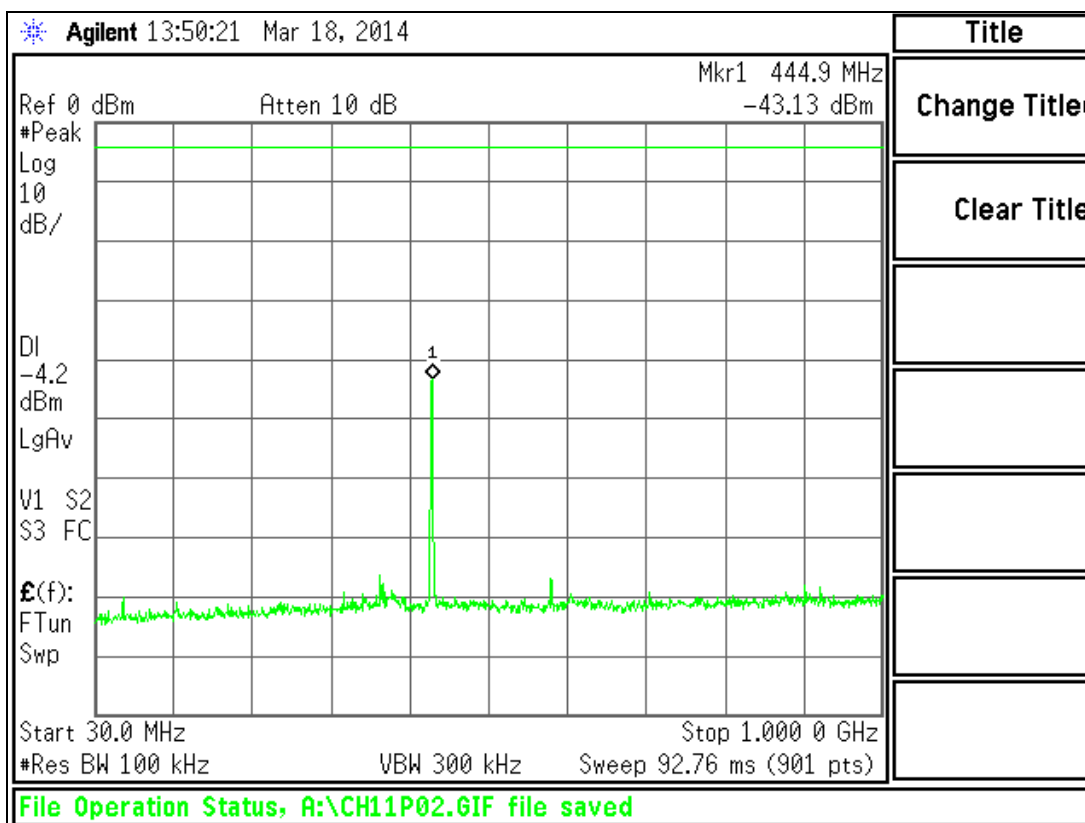

Conducted Spurious emissions 30 MHz to 1 GHz - 2405 MHz

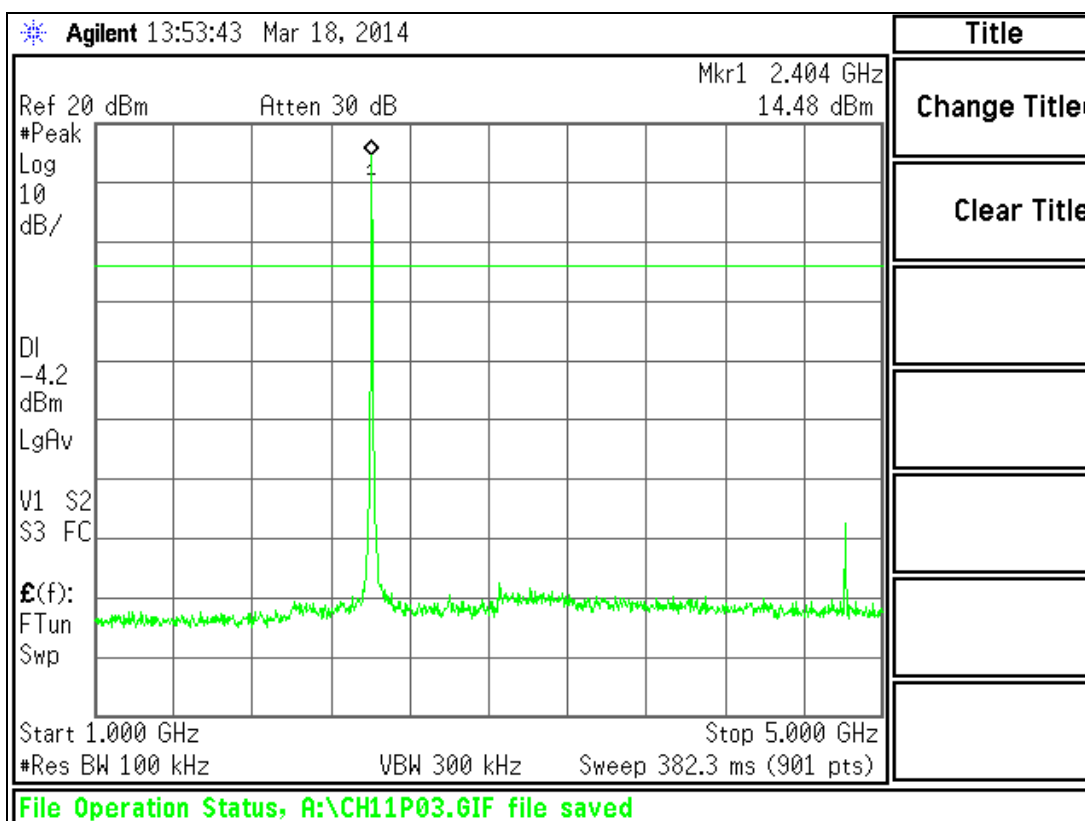

Conducted Spurious emissions 1 GHz to 5 GHz - 2405 MHz



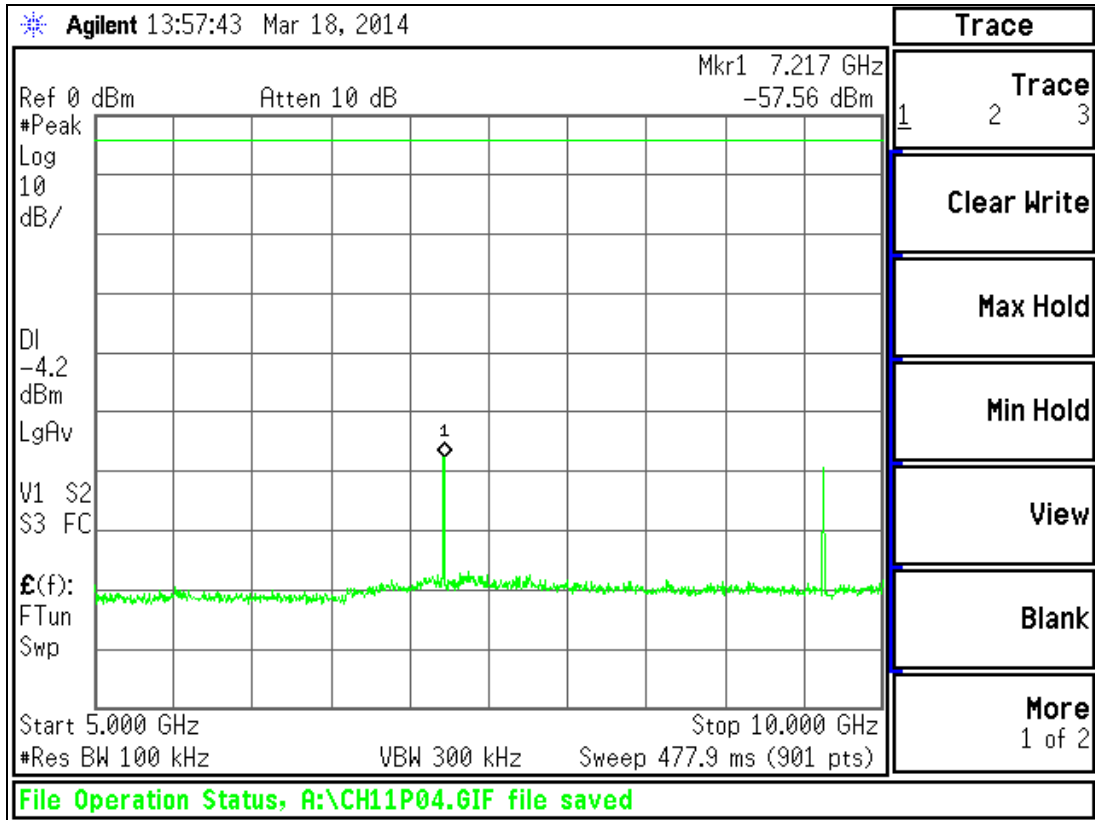

Conducted Spurious emissions 5 GHz to 10 GHz - 2405 MHz

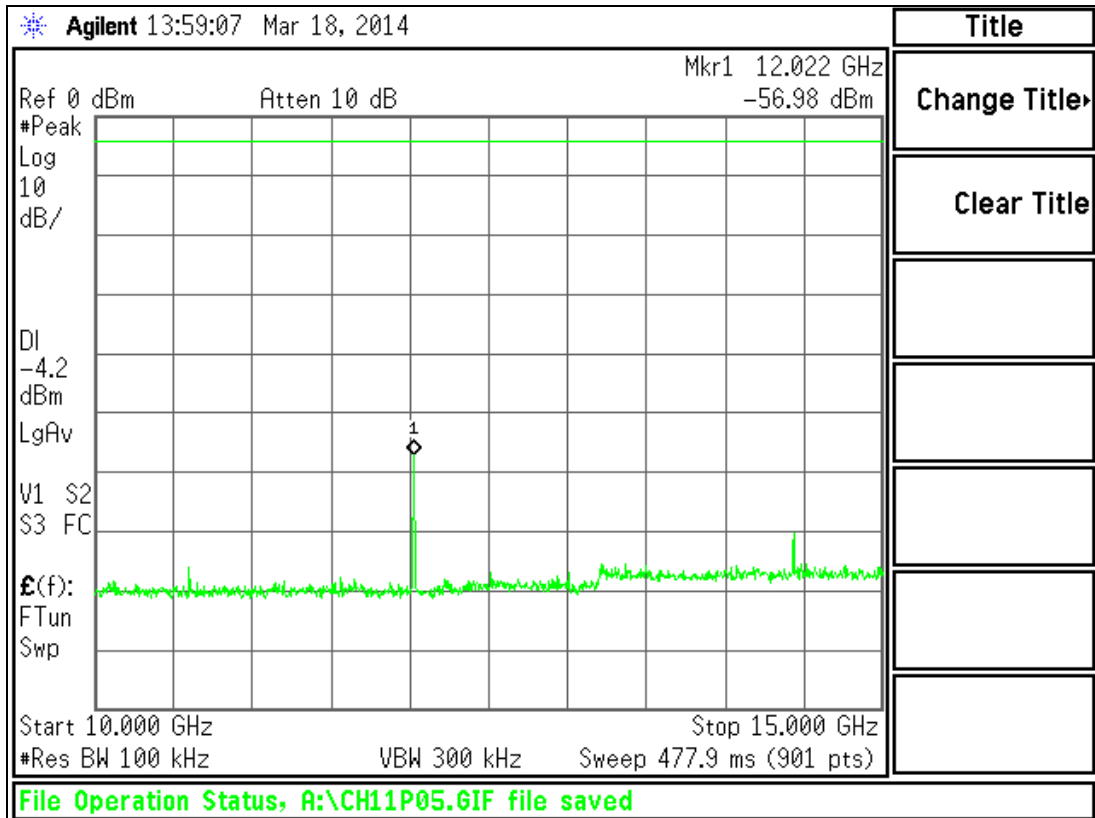

Conducted Spurious emissions 10 GHz to 15 GHz - 2405 MHz

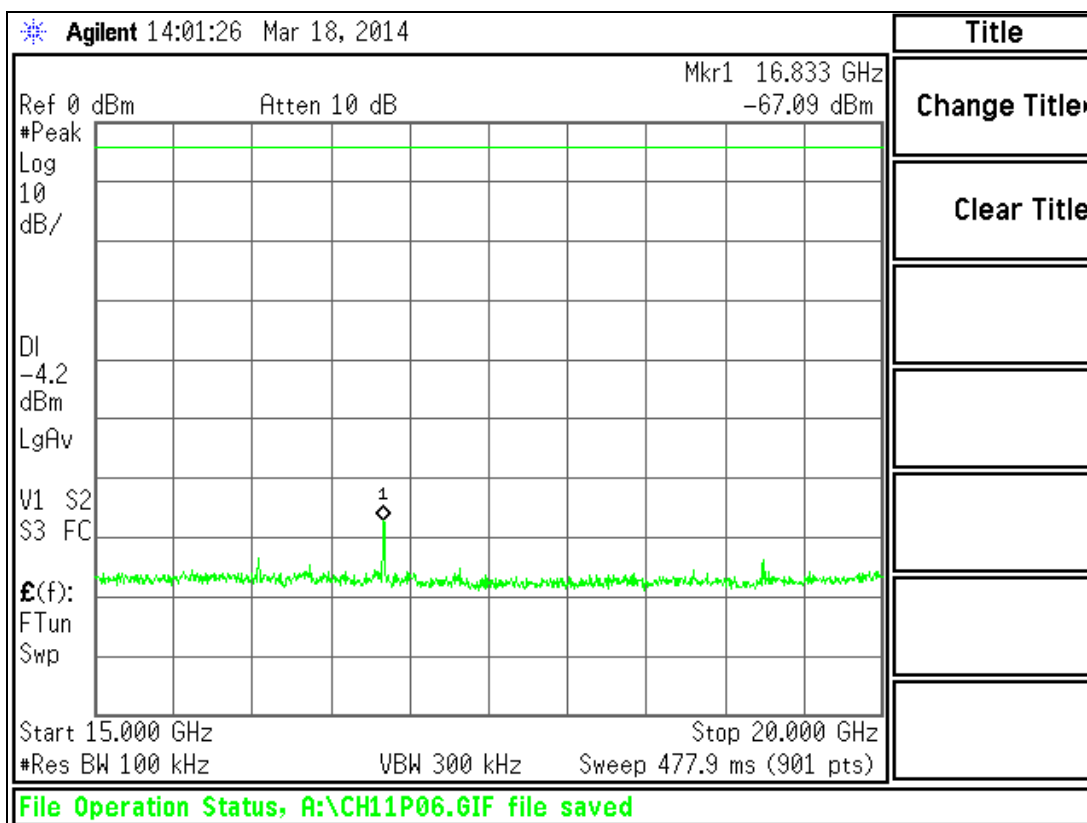

Conducted Spurious emissions 15 GHz to 20GHz - 2405 MHz

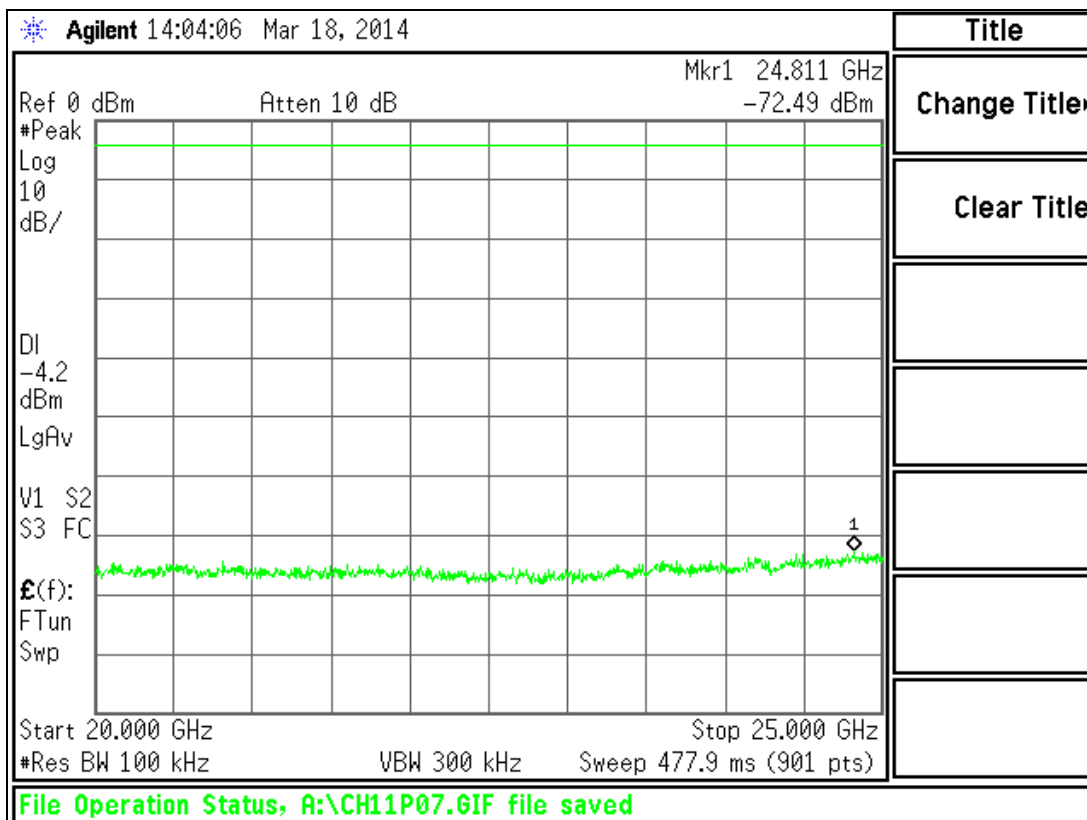

Conducted Spurious emissions 20 GHz to 25GHz - 2405 MHz

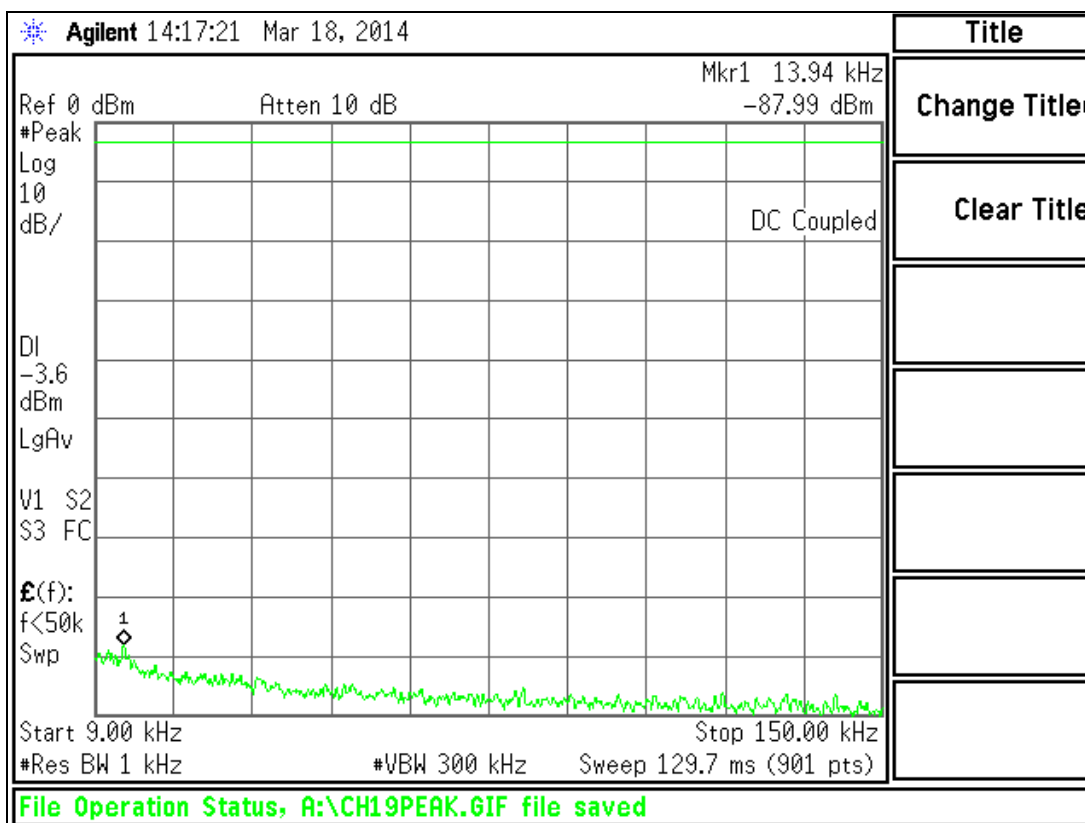

Conducted Spurious emissions 9kHz to 150 kHz – 2445 MHz

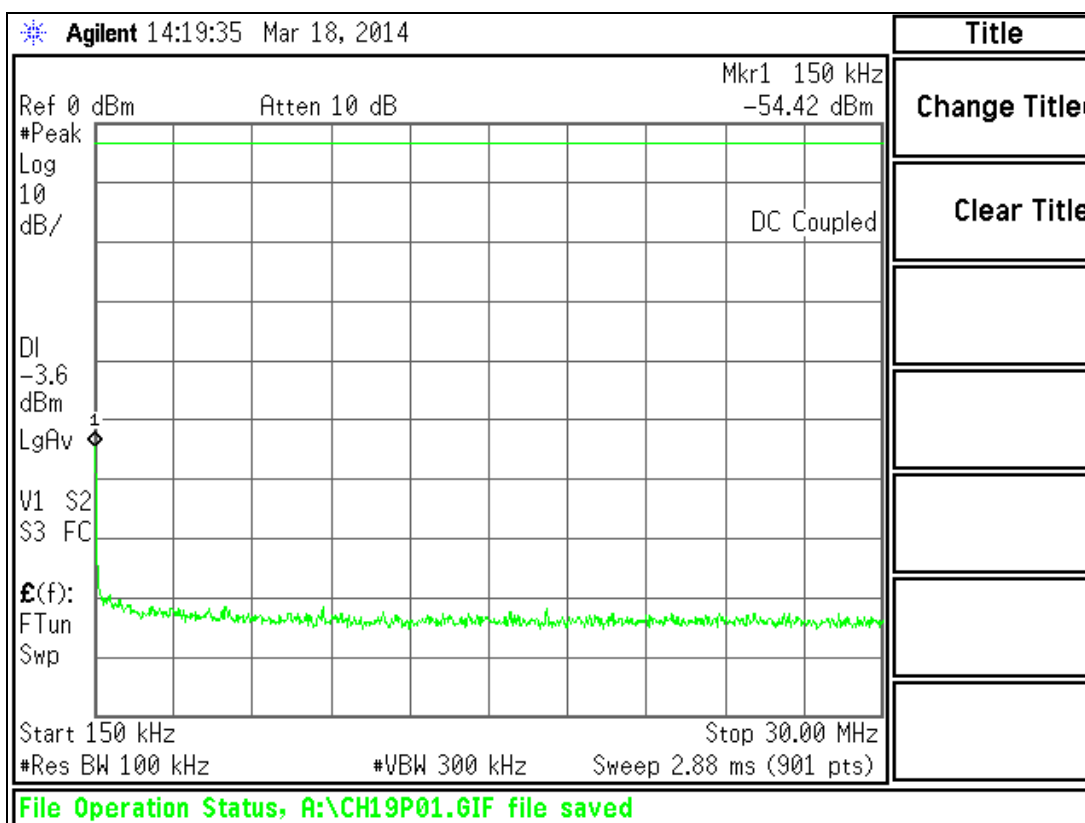

Conducted Spurious emissions 150 kHz to 30 MHz – 2445 MHz

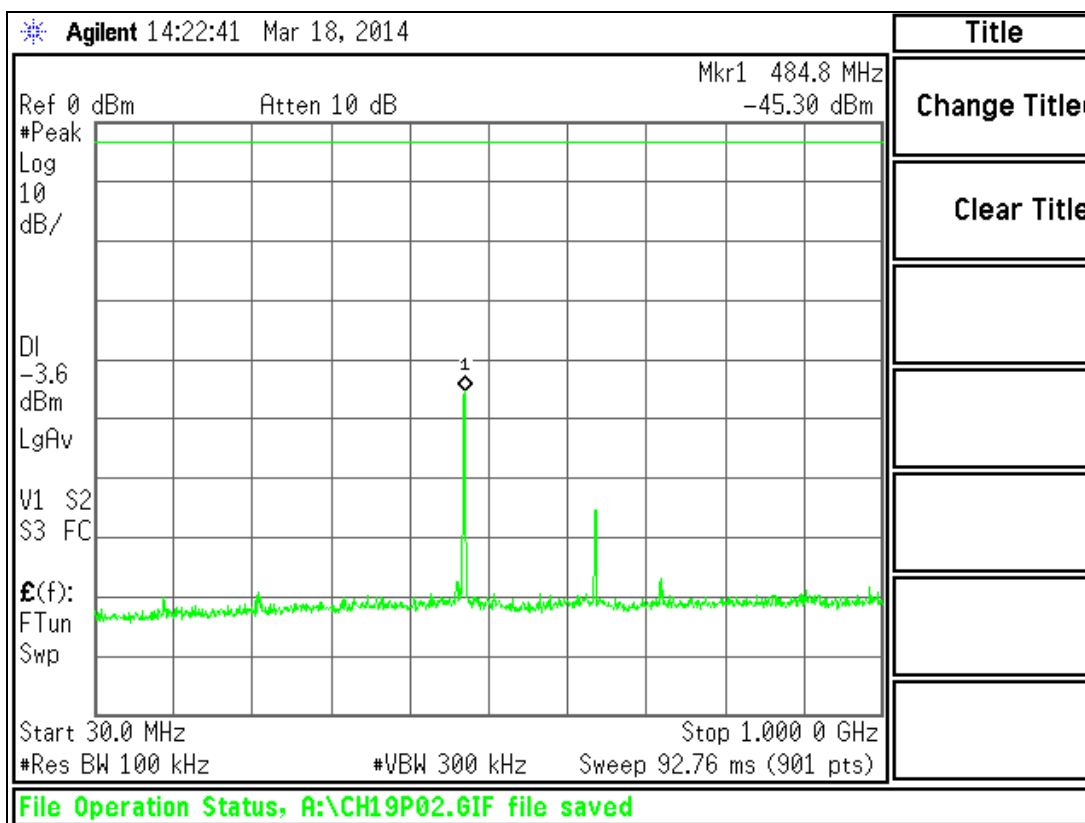

Conducted Spurious emissions 30 MHz to 1 GHz - 2445 MHz

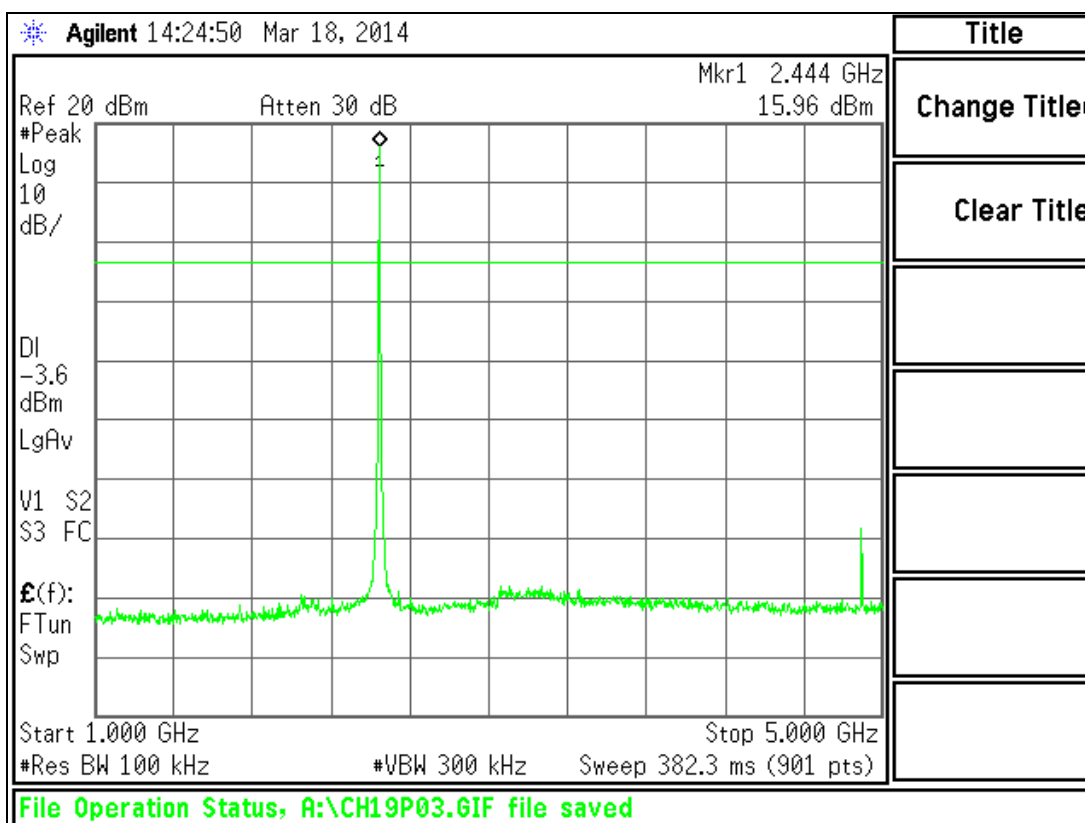

Conducted Spurious emissions 1 GHz to 5 GHz - 2445 MHz

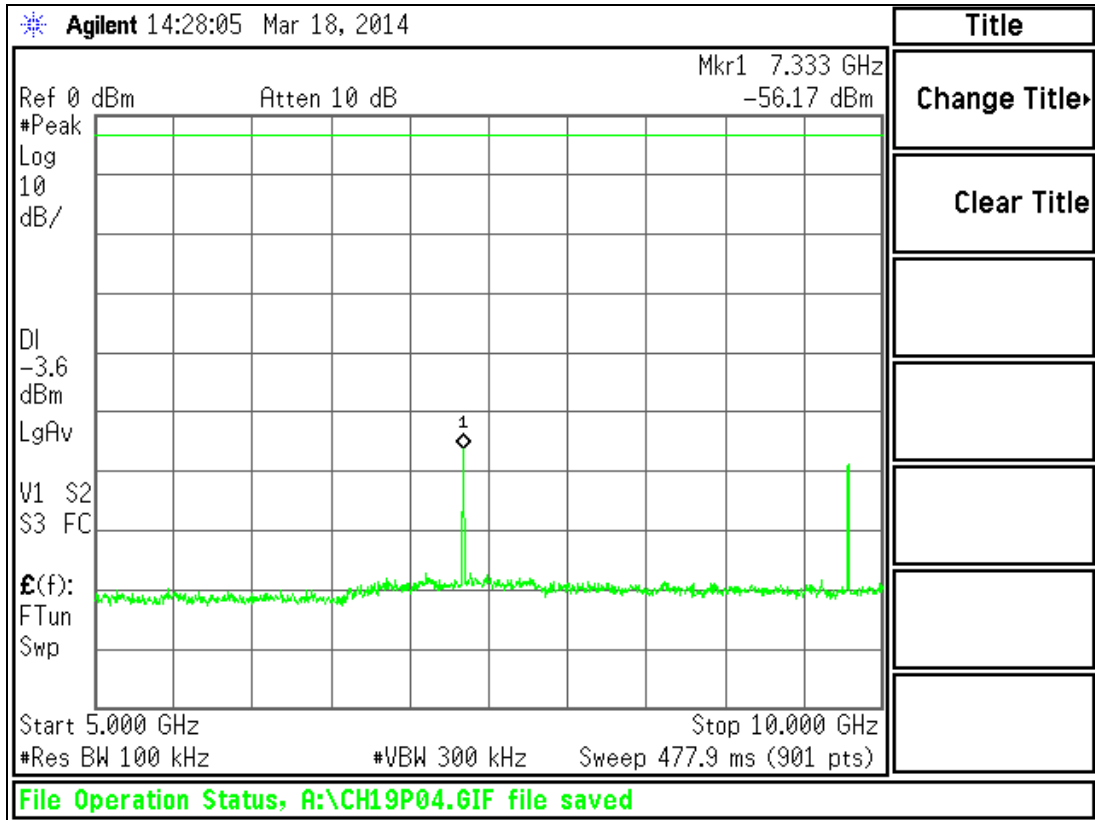

Conducted Spurious emissions 5 GHz to 10 GHz - 2445 MHz

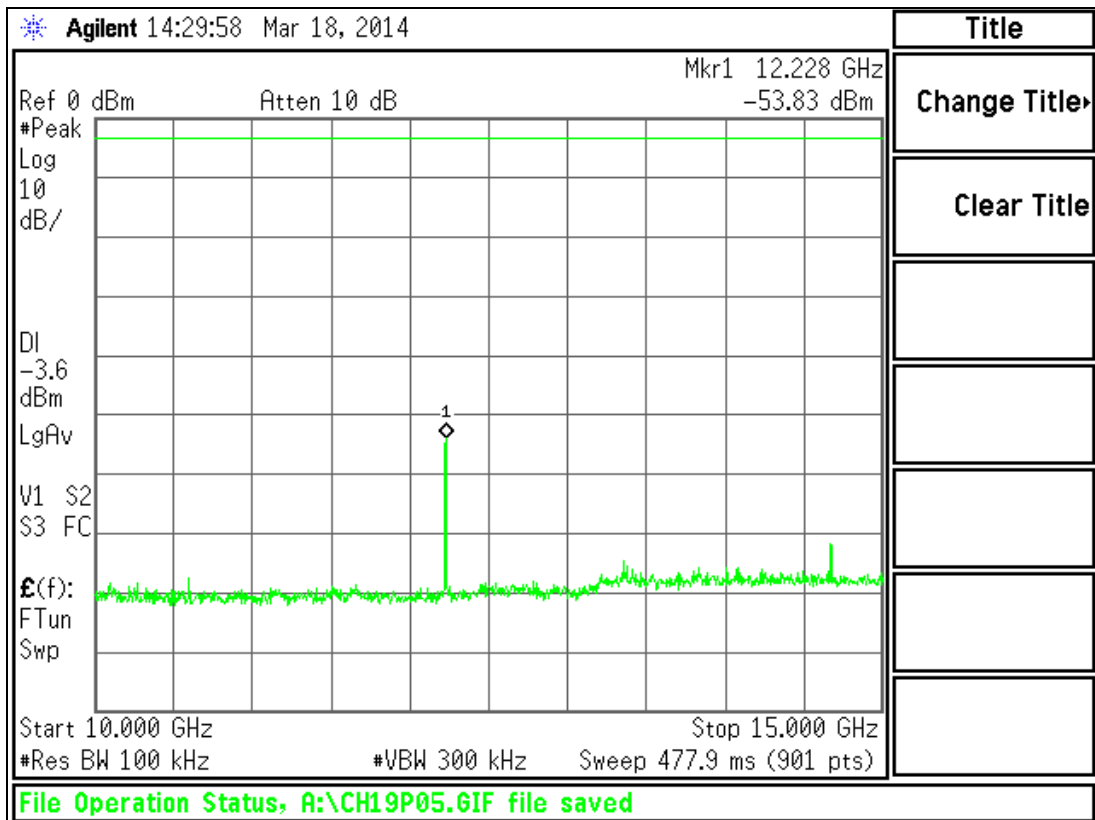

Conducted Spurious emissions 10 GHz to 15 GHz - 2445 MHz

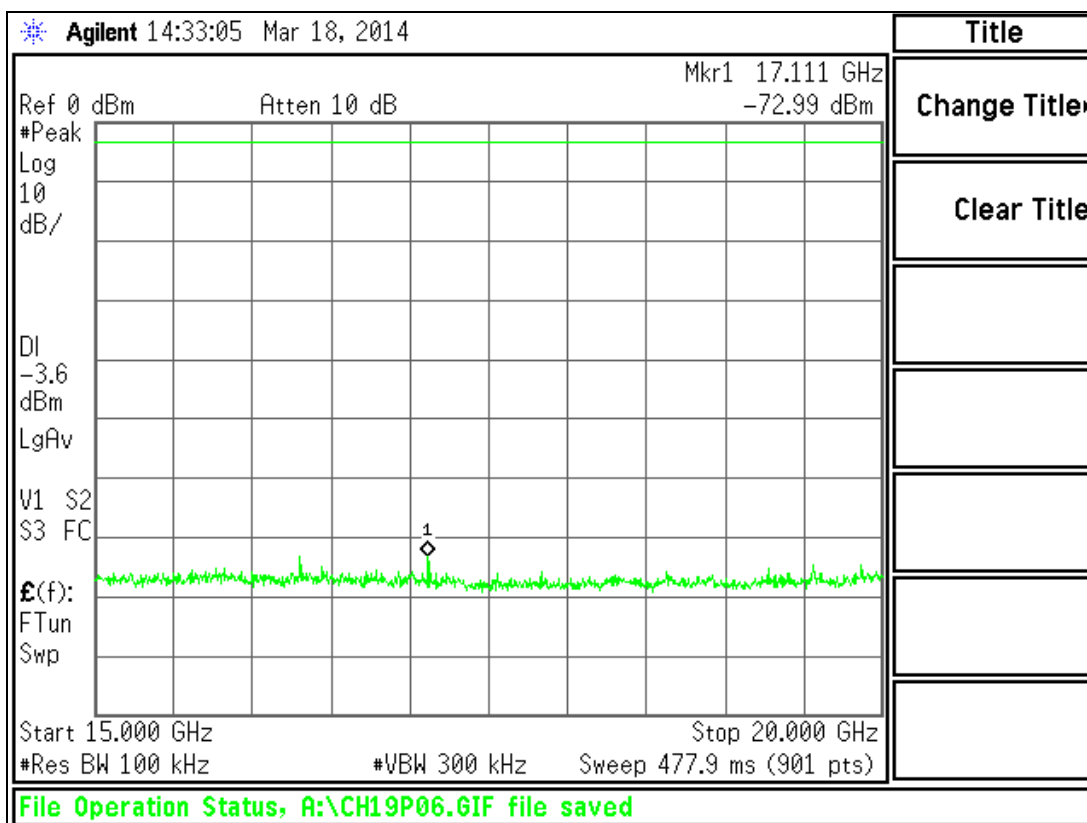

Conducted Spurious emissions 15 GHz to 20GHz - 2445 MHz

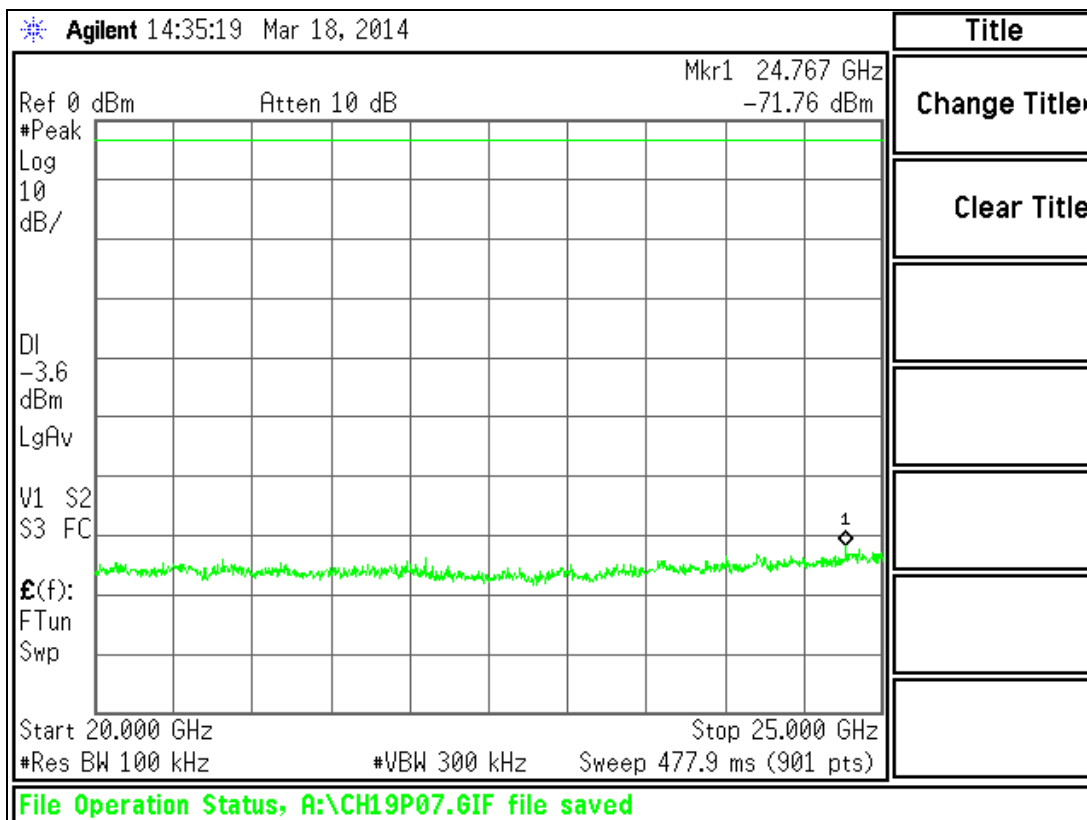

Conducted Spurious emissions 20 GHz to 25GHz - 2445 MHz

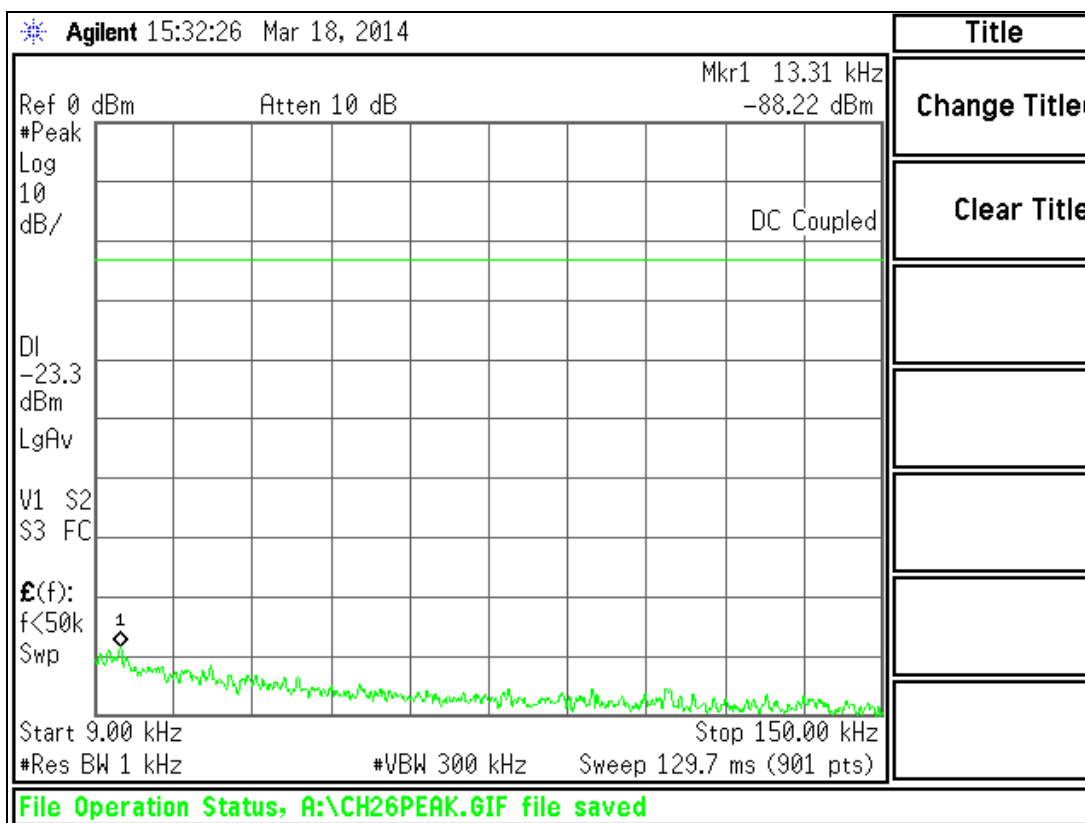

Conducted Spurious emissions 9kHz to 150 kHz – 2480 MHz

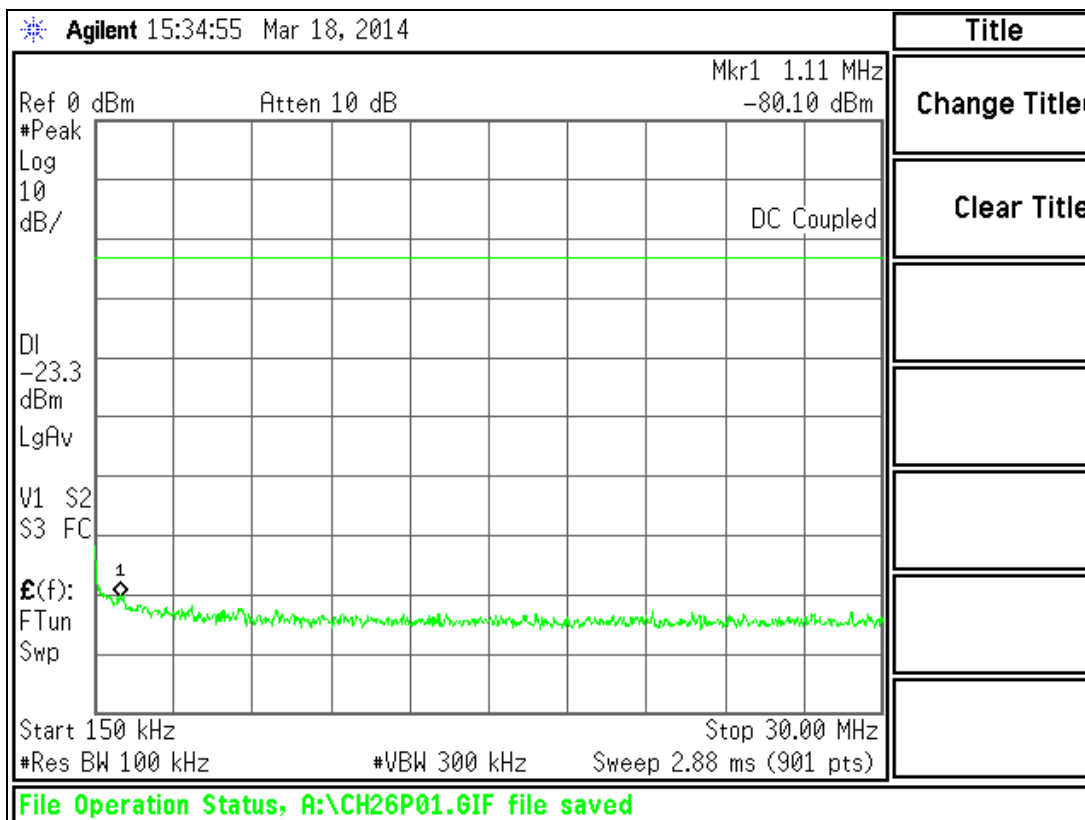

Conducted Spurious emissions 150 kHz to 30 MHz – 2480 MHz

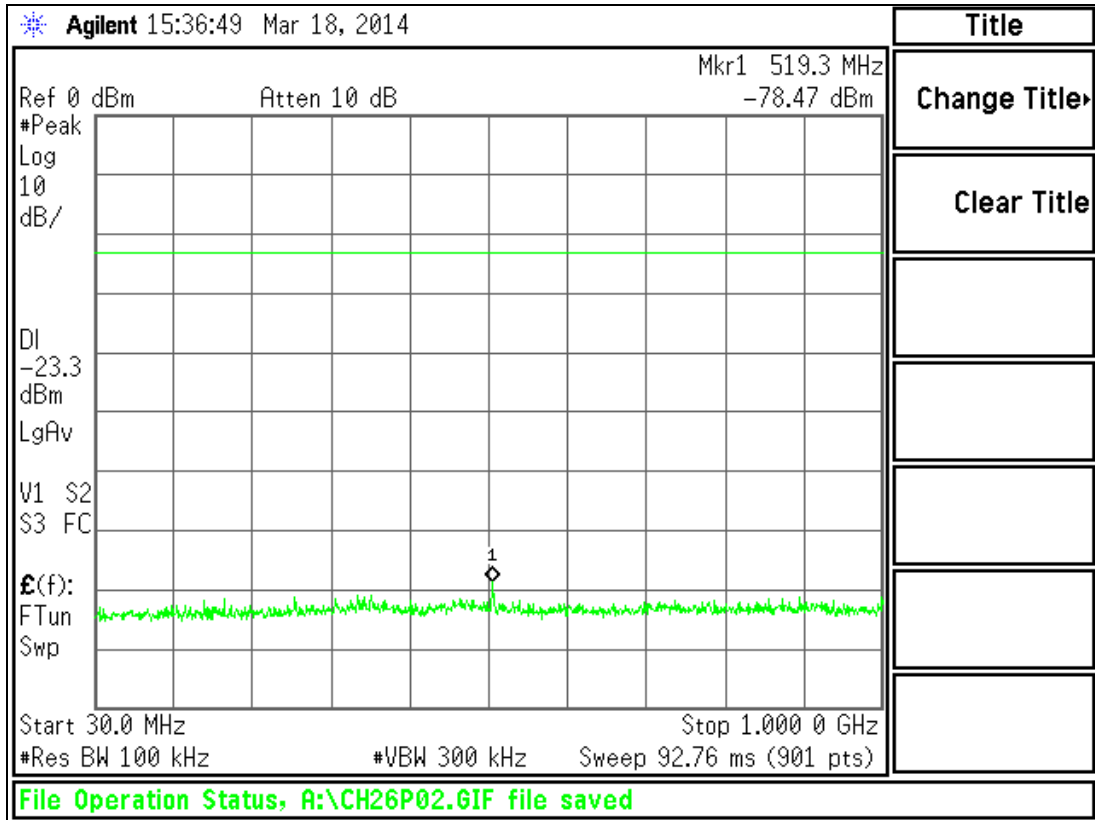

Conducted Spurious emissions 30 MHz to 1 GHz - 2480 MHz

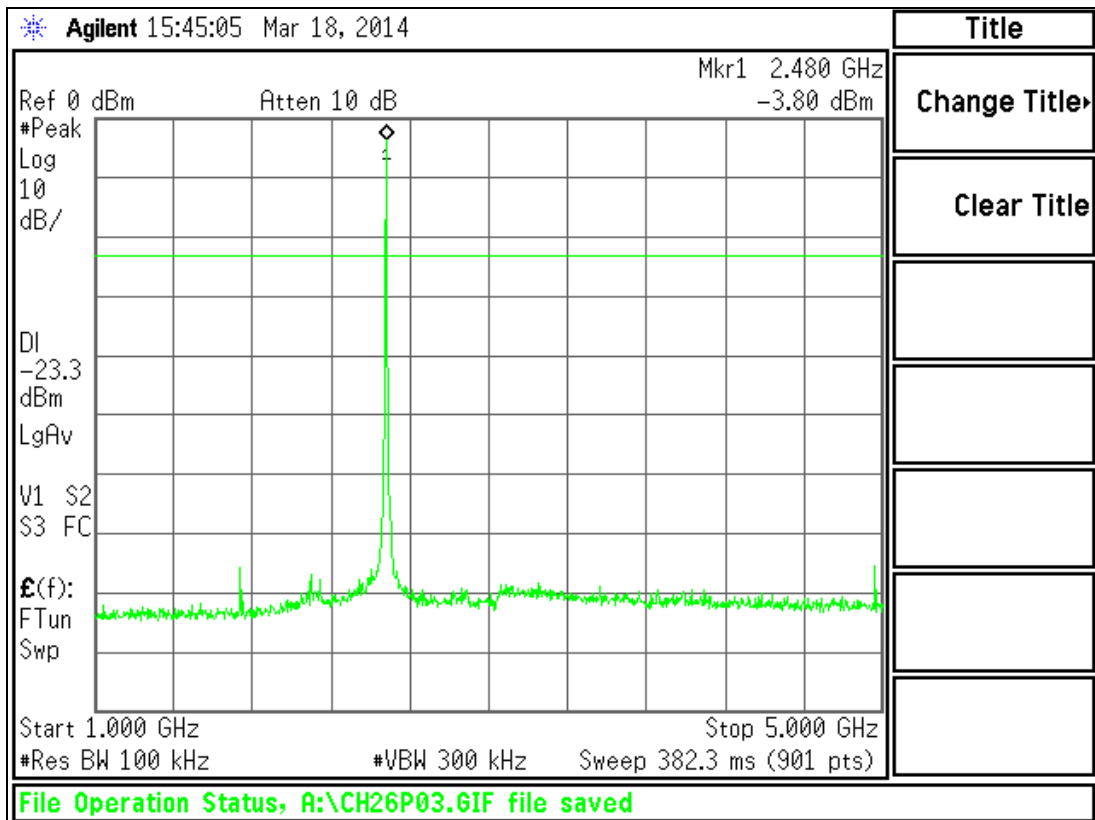

Conducted Spurious emissions 1 GHz to 5 GHz - 2480 MHz



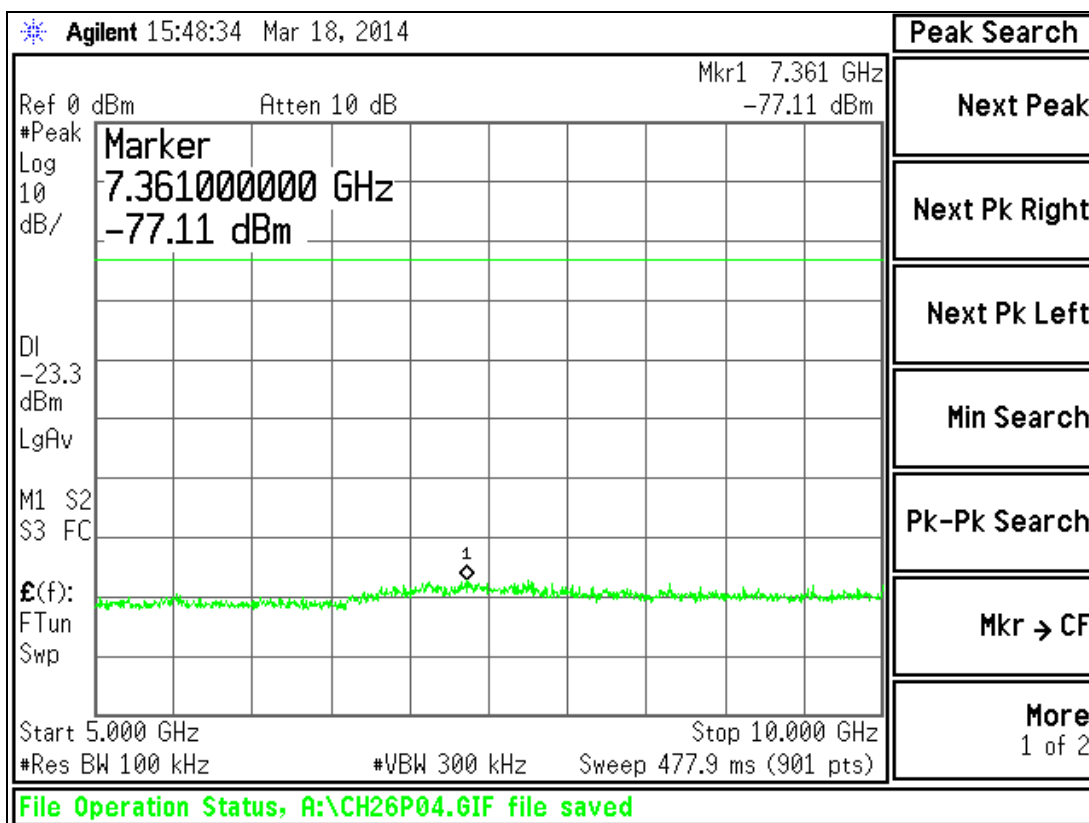

Conducted Spurious emissions 5 GHz to 10 GHz - 2480 MHz

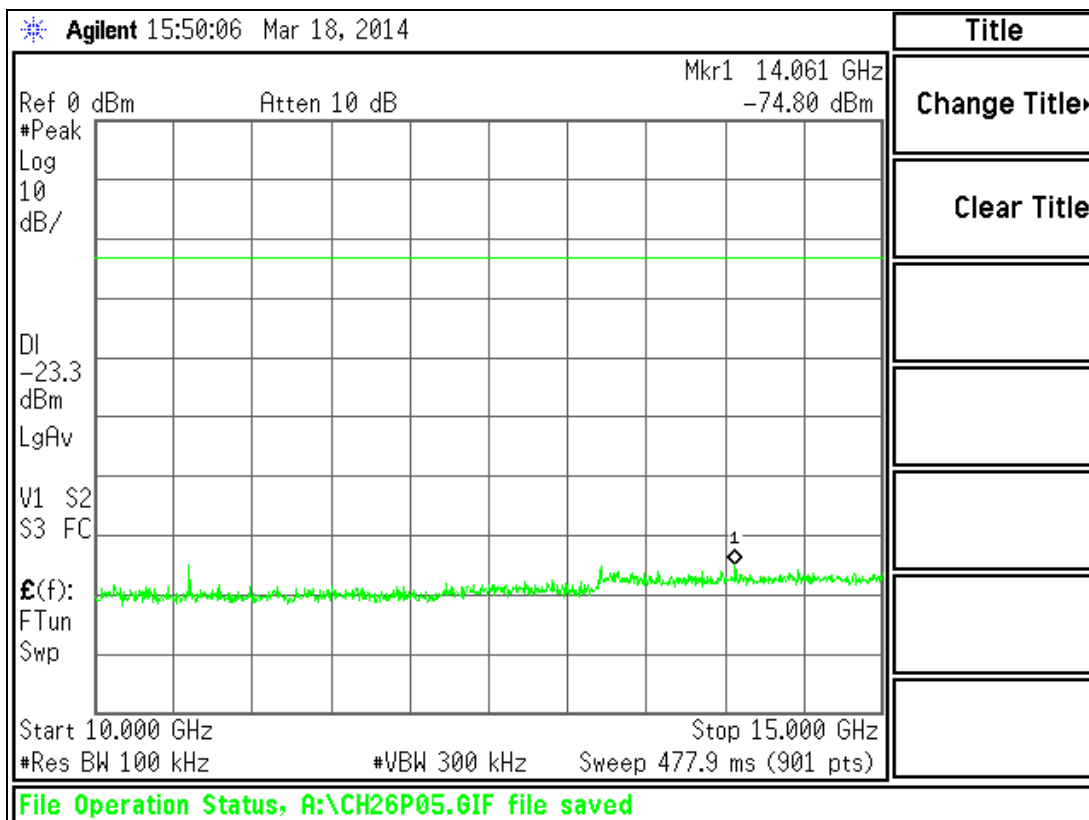

Conducted Spurious emissions 10 GHz to 15 GHz - 2480 MHz

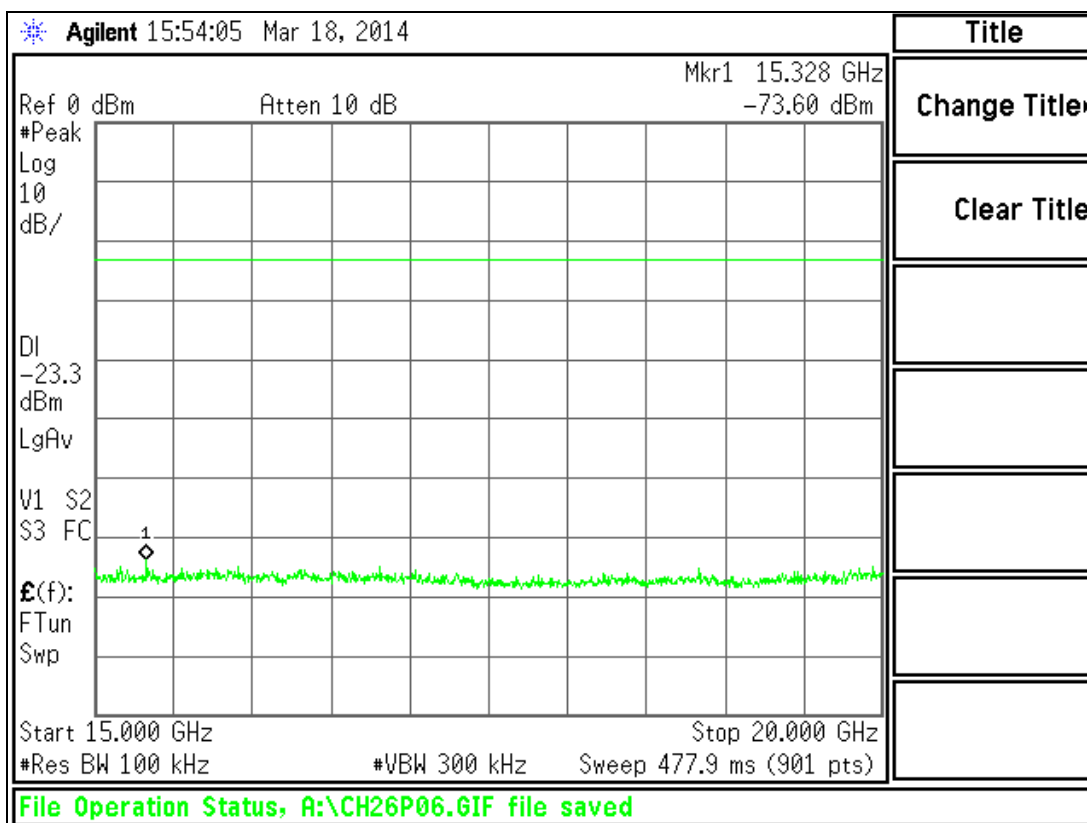

Conducted Spurious emissions 15 GHz to 20GHz - 2480 MHz

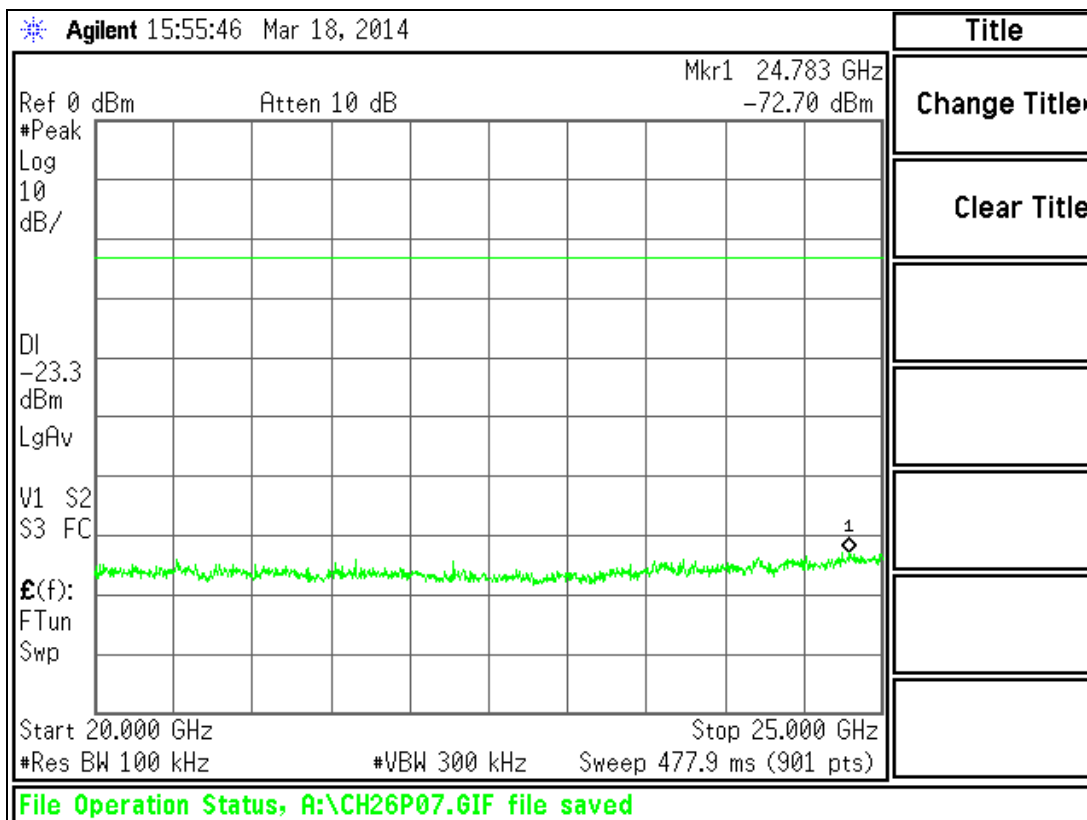

Conducted Spurious emissions 20 GHz to 25GHz - 2480 MHz

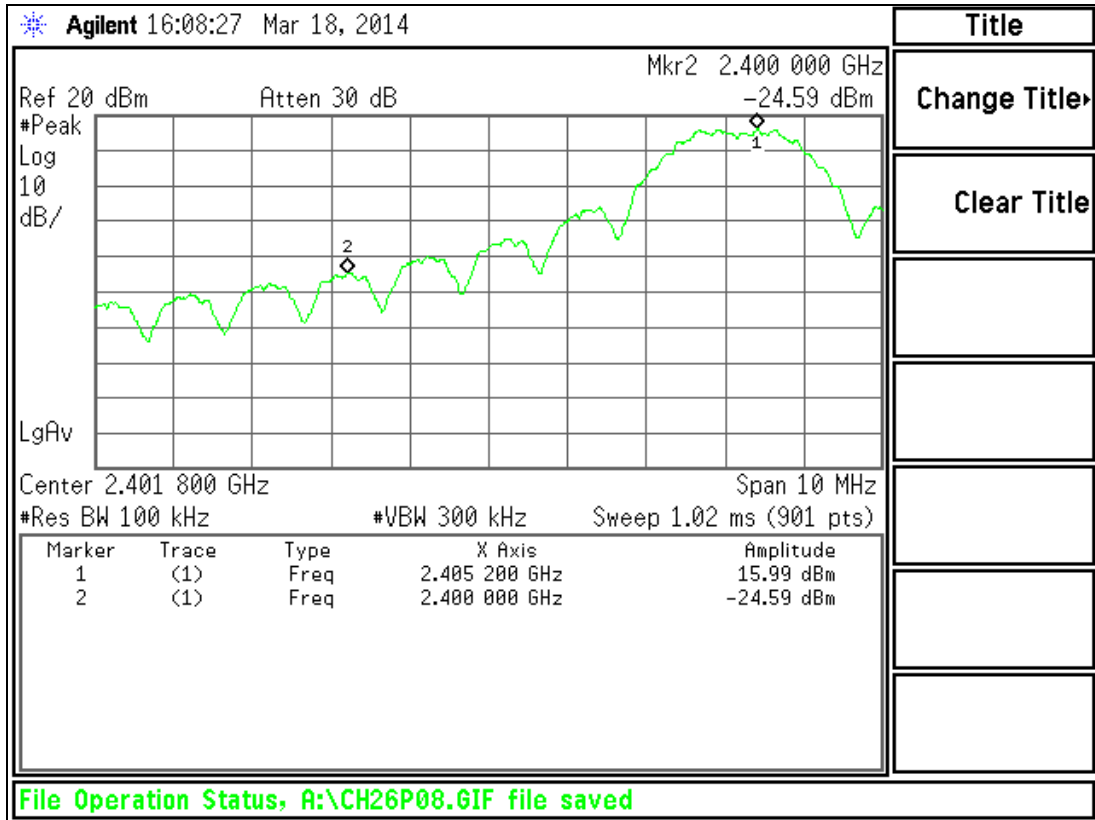

Lower Band Edge – 2405 MHz

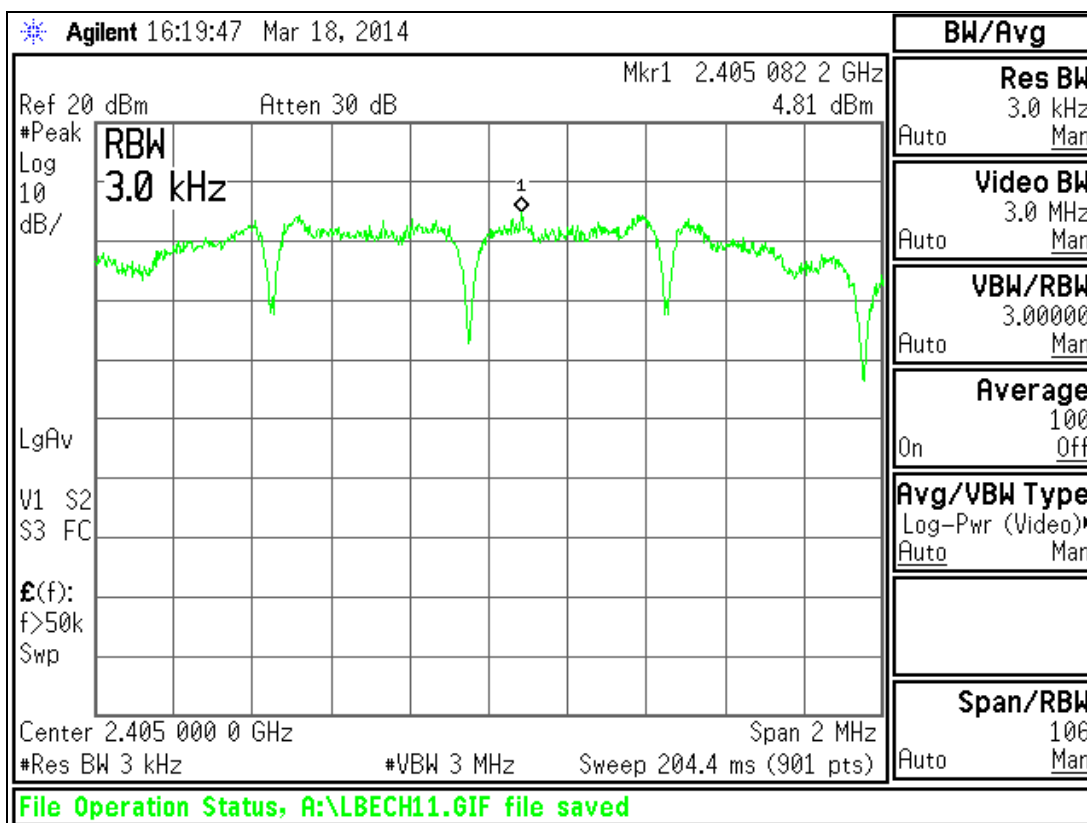

Conducted power spectral density (-7dBm) 2405 MHz

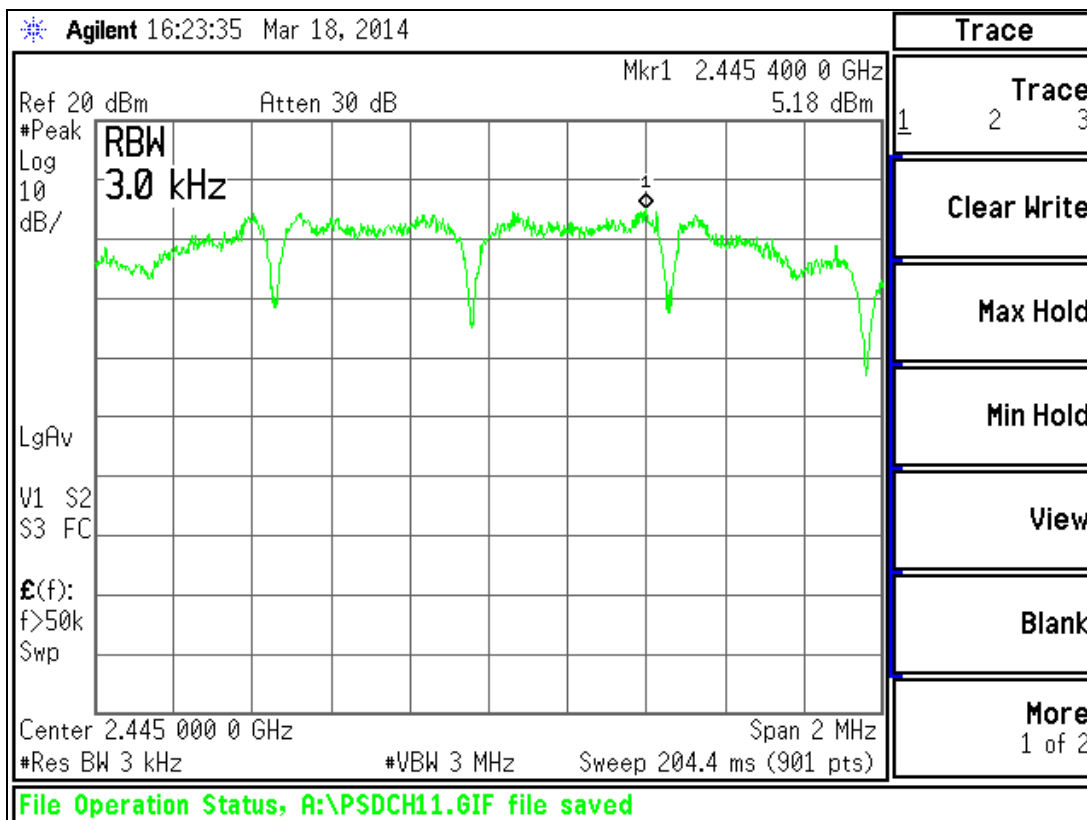

Conducted power spectral density (-7dBm) 2445 MHz

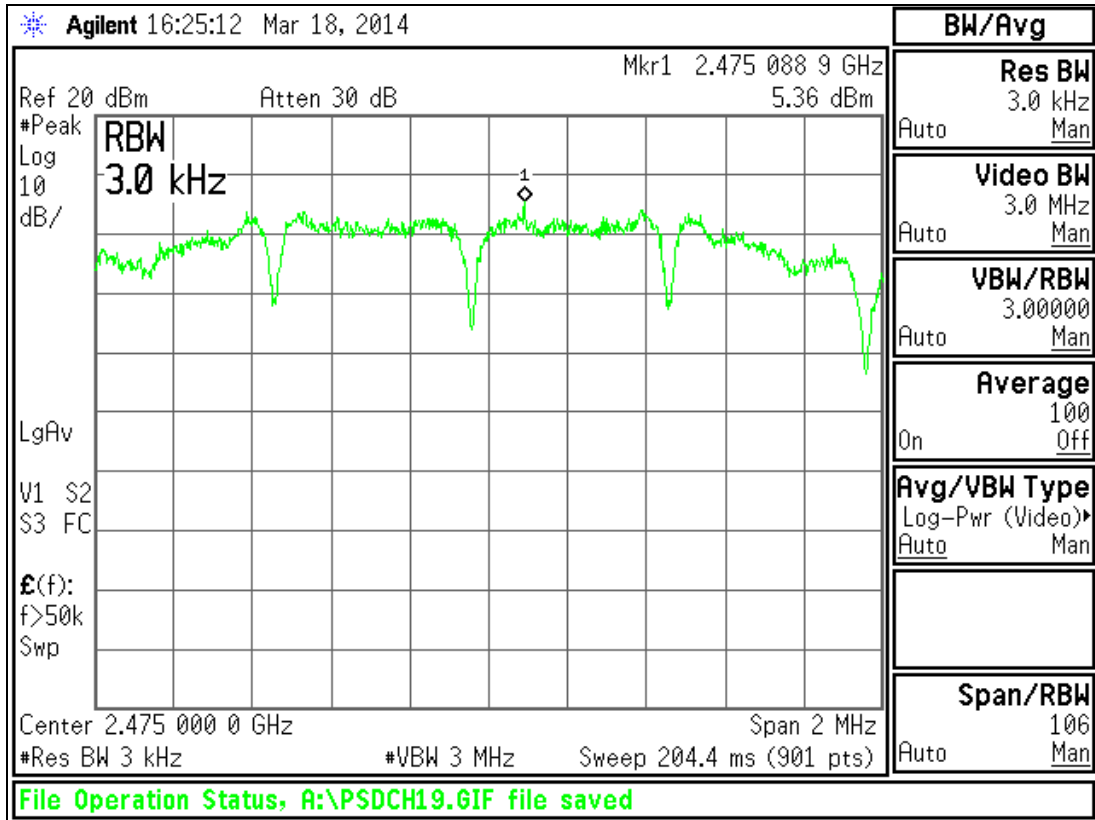

Conducted power spectral density (-7dBm) 2475 MHz

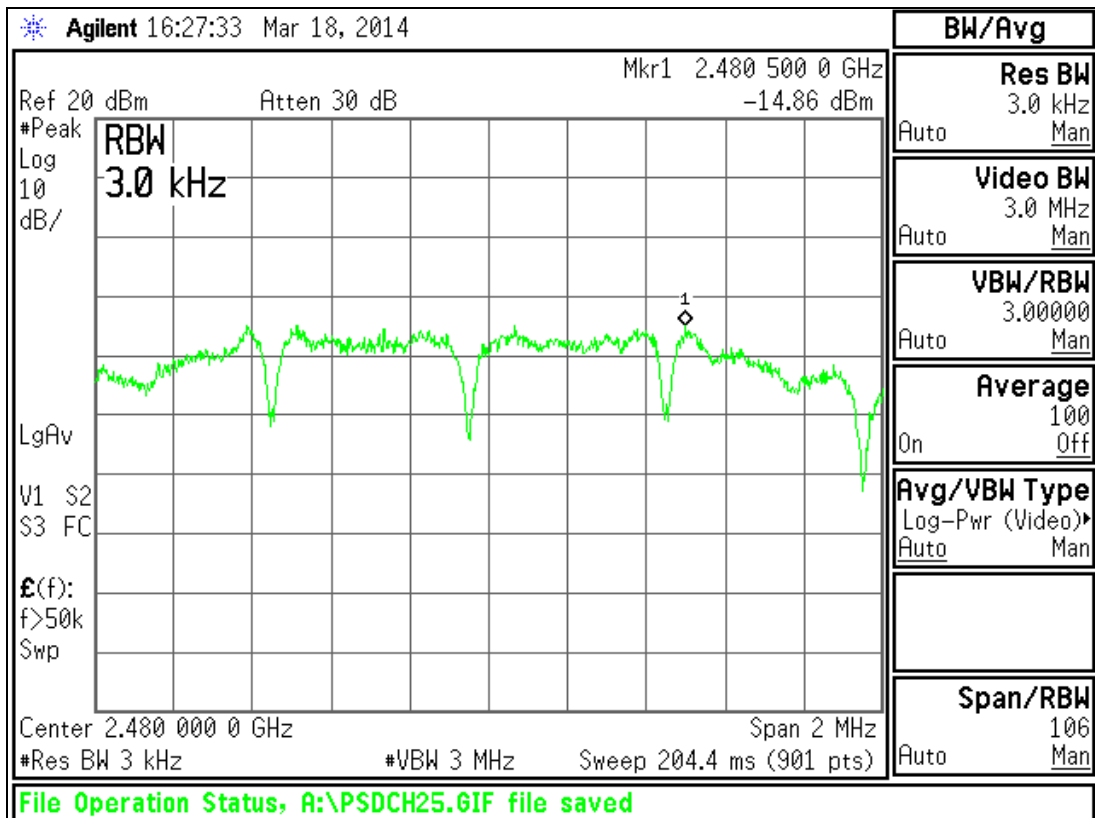

Conducted power spectral density (-15dBm) 2480 MHz

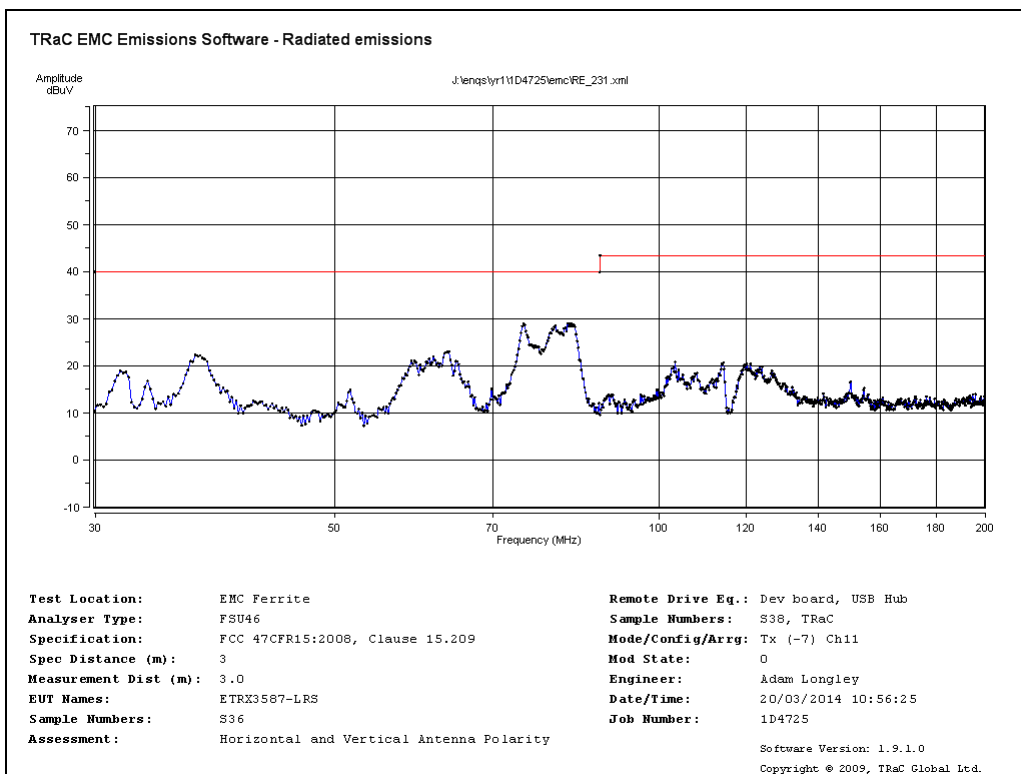

Radiated Transmitter Emissions Channel 11 2405MHz (15.209) Chip Antenna  
30MHz -200MHz

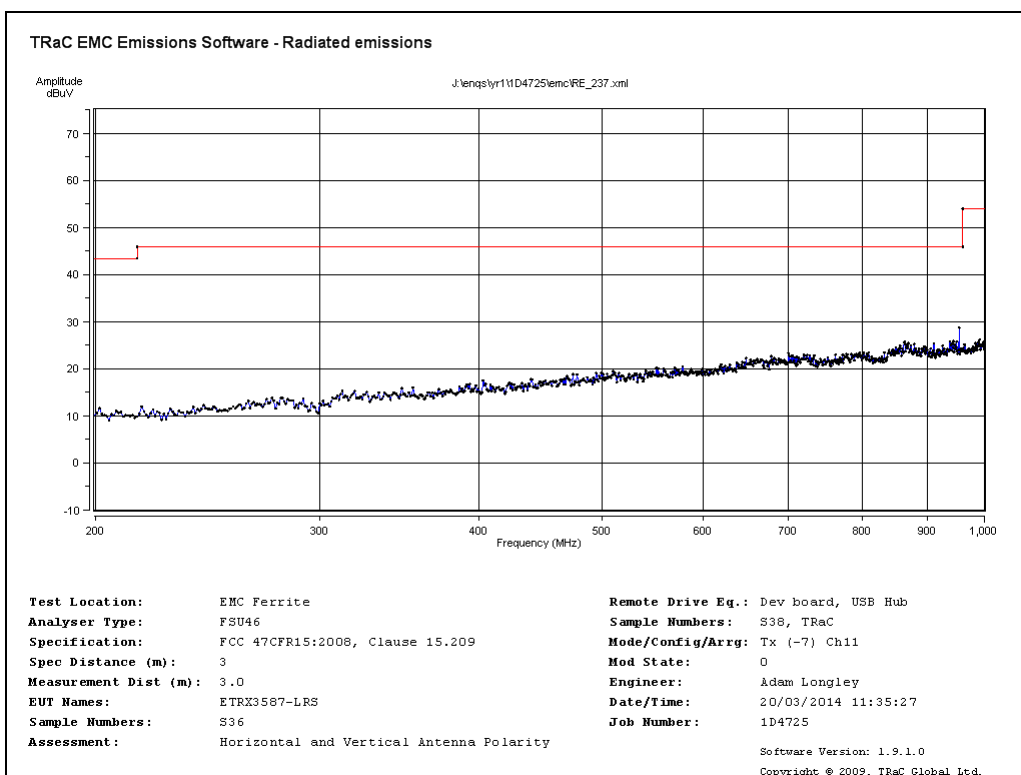

Radiated Transmitter Emissions Channel 11 2405MHz (15.209) Chip Antenna  
200MHz - 1GHz

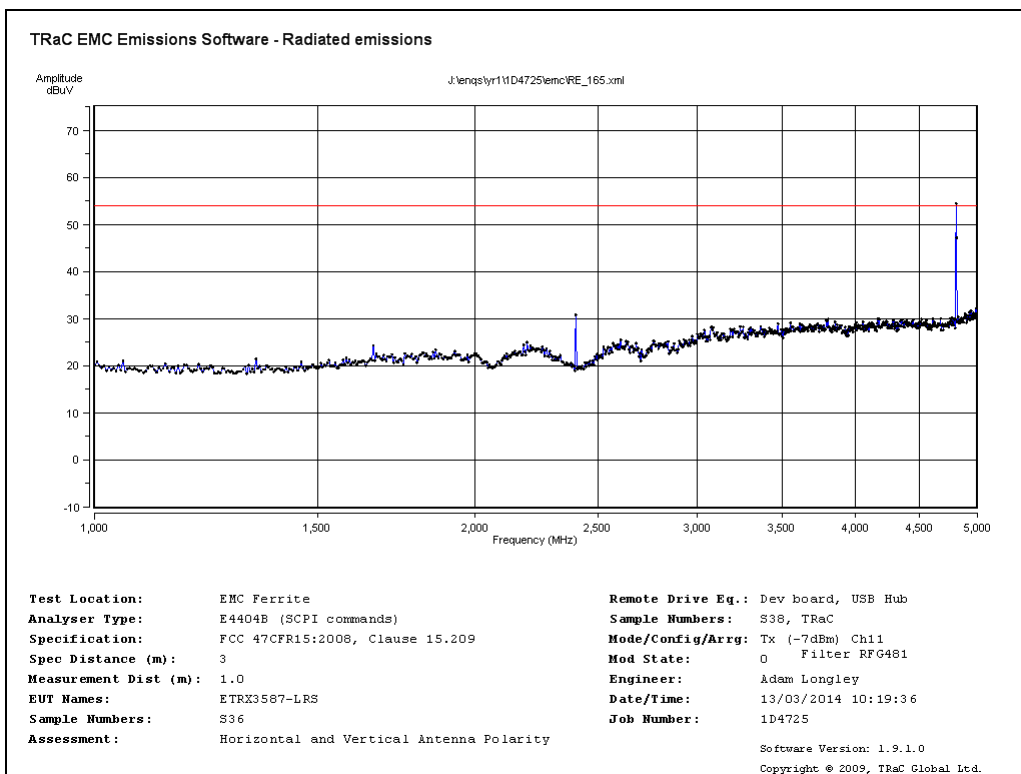

Radiated Transmitter Emissions Channel 11 2405MHz (15.209) Chip Antenna  
1GHz- 5GHz

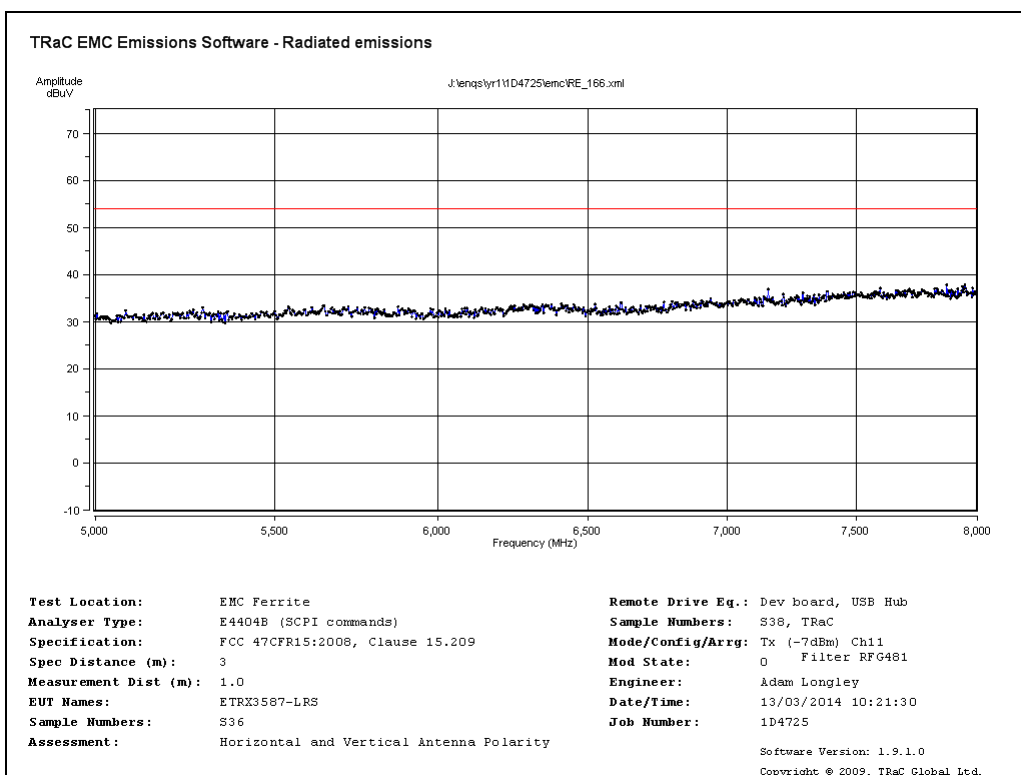

Radiated Transmitter Emissions Channel 11 2405MHz (15.209) Chip Antenna  
5GHz- 8GHz

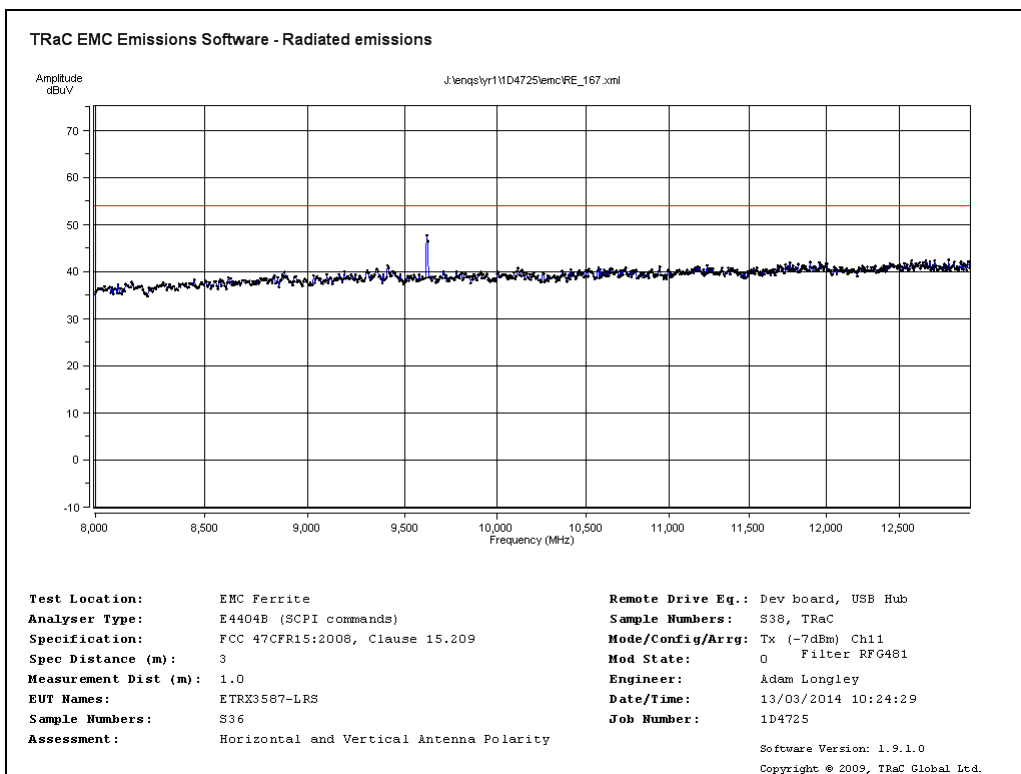

Radiated Transmitter Emissions Channel 11 2405MHz (15.209) Chip Antenna  
8GHz- 13GHz

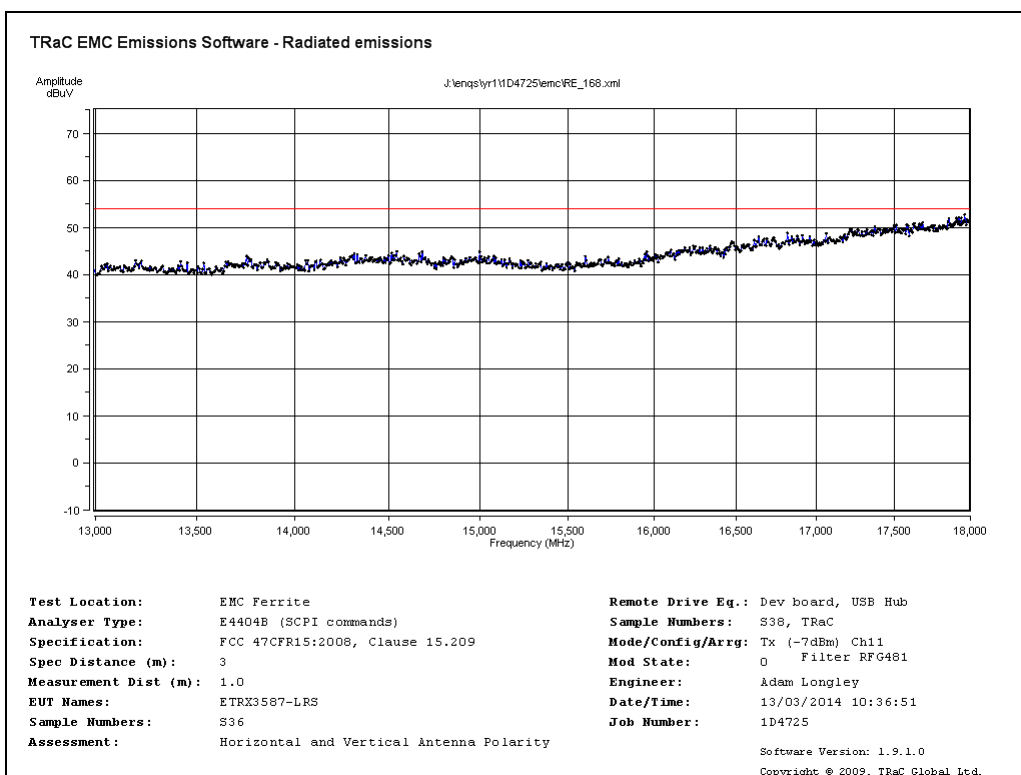

Radiated Transmitter Emissions Channel 11 2405MHz (15.209) Chip Antenna  
13GHz- 18GHz



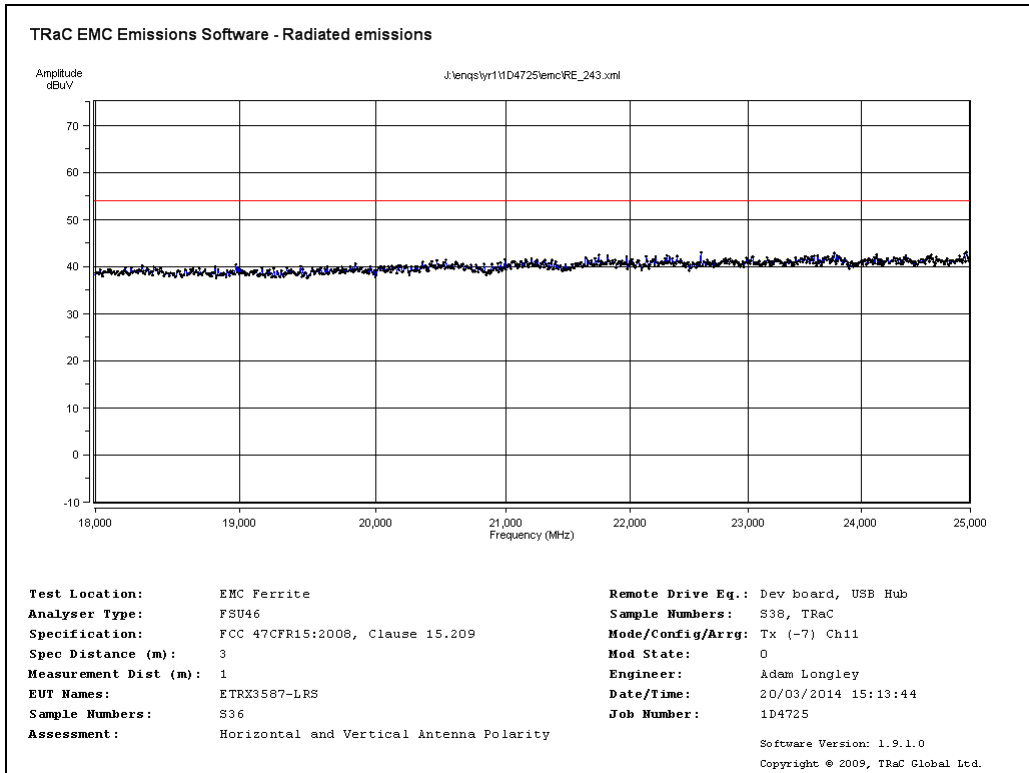

Radiated Transmitter Emissions Channel 11 2405MHz (15.209) Chip Antenna  
18GHz- 25GHz

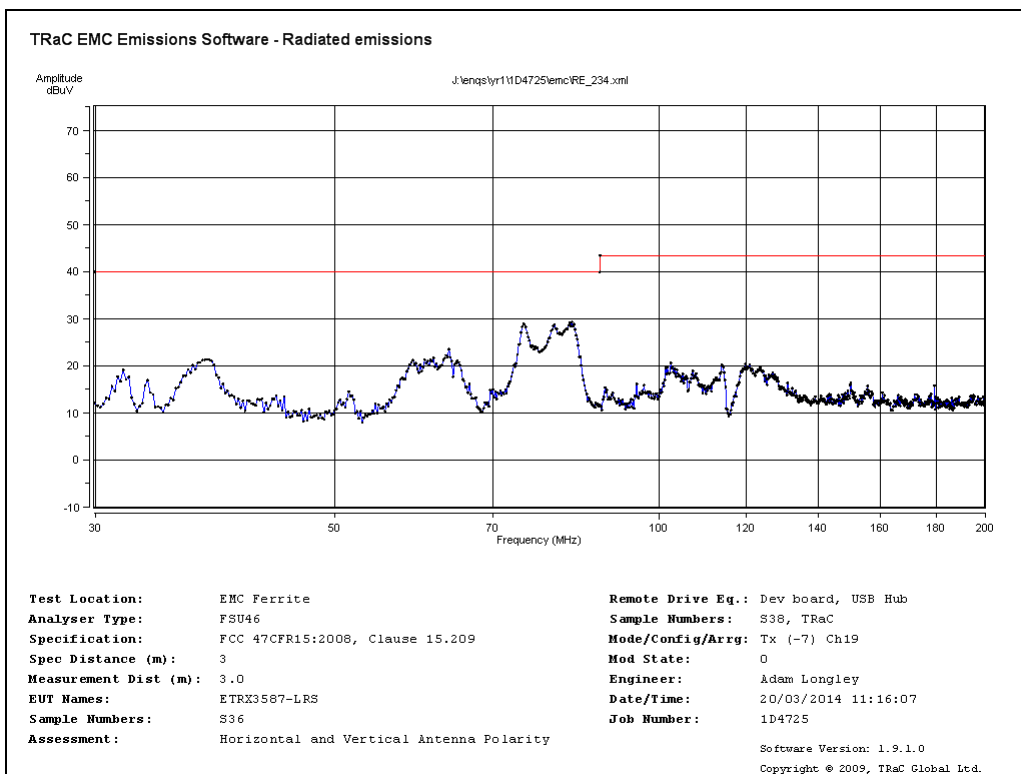

Radiated Transmitter Emissions Channel 19 2445MHz (15.209) Chip Antenna  
30MHz -200MHz

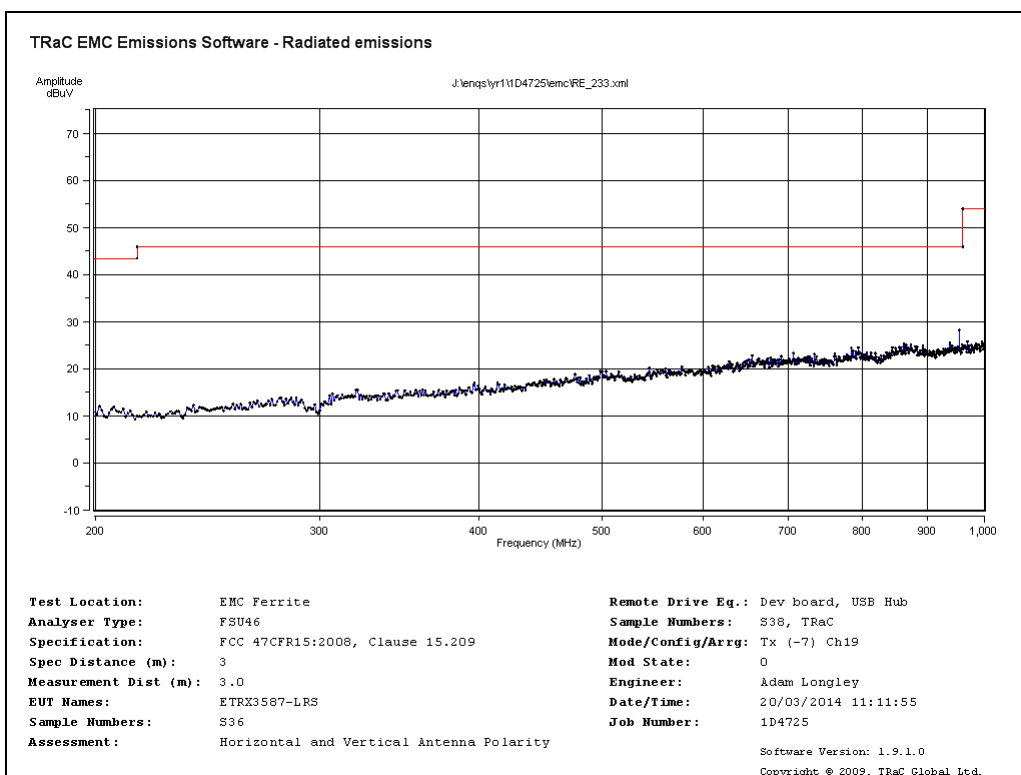

Radiated Transmitter Emissions Channel 19 2445MHz (15.209) Chip Antenna  
200MHz -1GHz

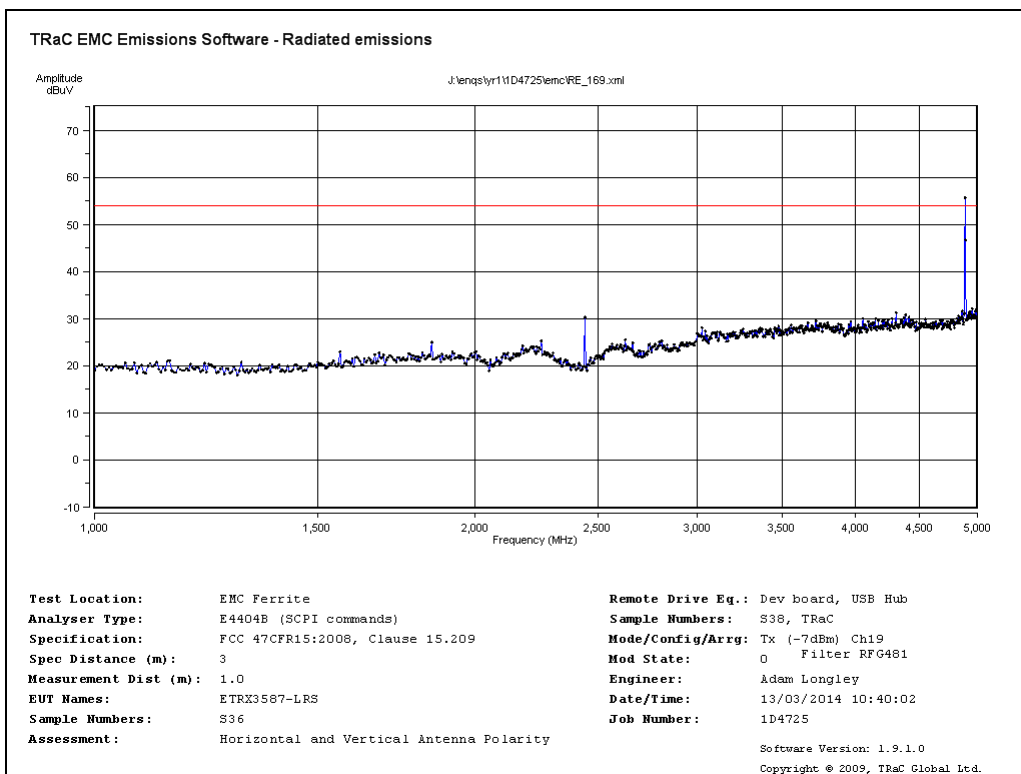

Radiated Transmitter Emissions Channel 19 2445MHz (15.209) Chip Antenna  
1GHz -5GHz

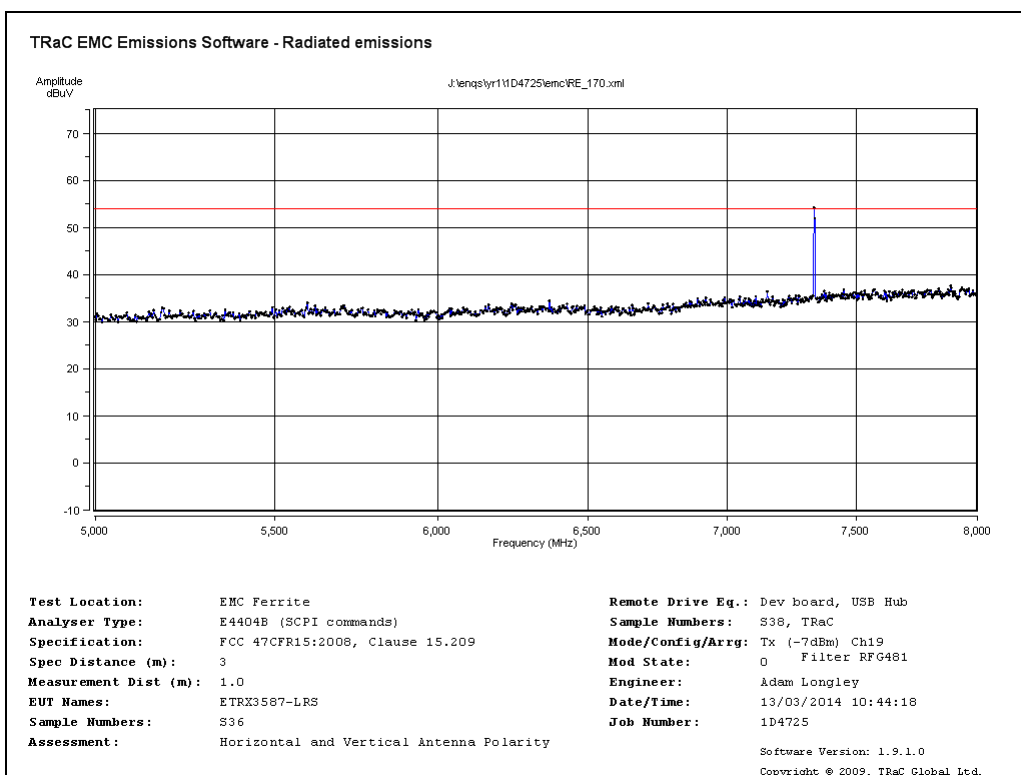

Radiated Transmitter Emissions Channel 19 2445MHz (15.209) Chip Antenna  
5GHz -8GHz

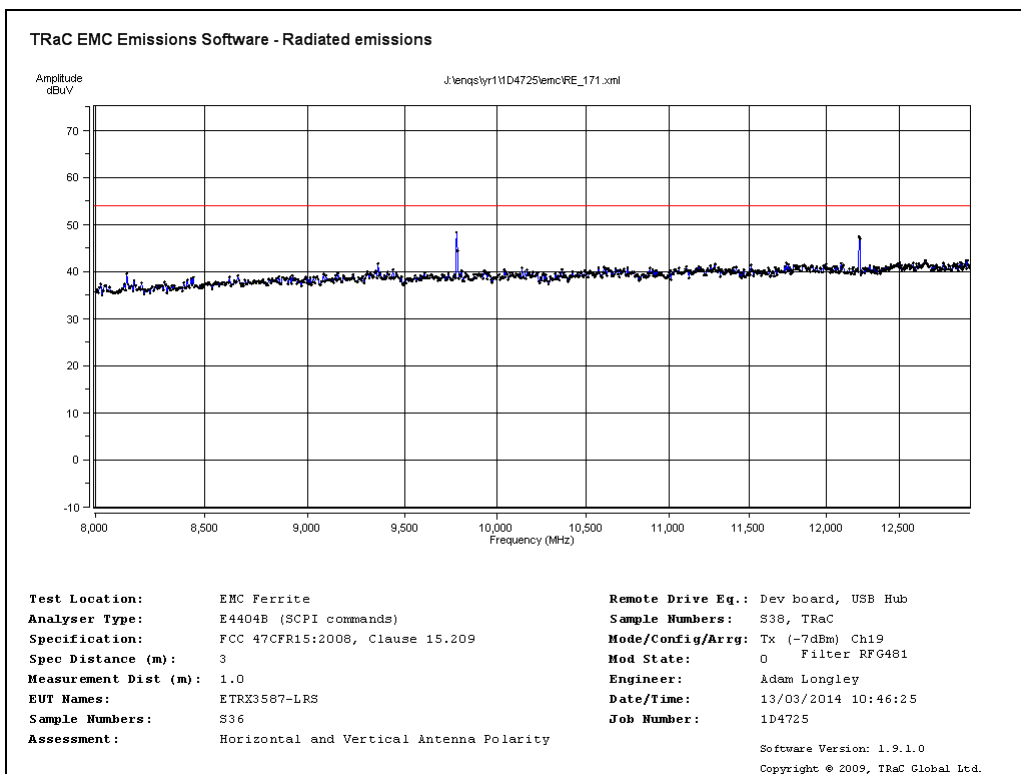

Radiated Transmitter Emissions Channel 19 2445MHz (15.209) Chip Antenna  
8GHz -13GHz

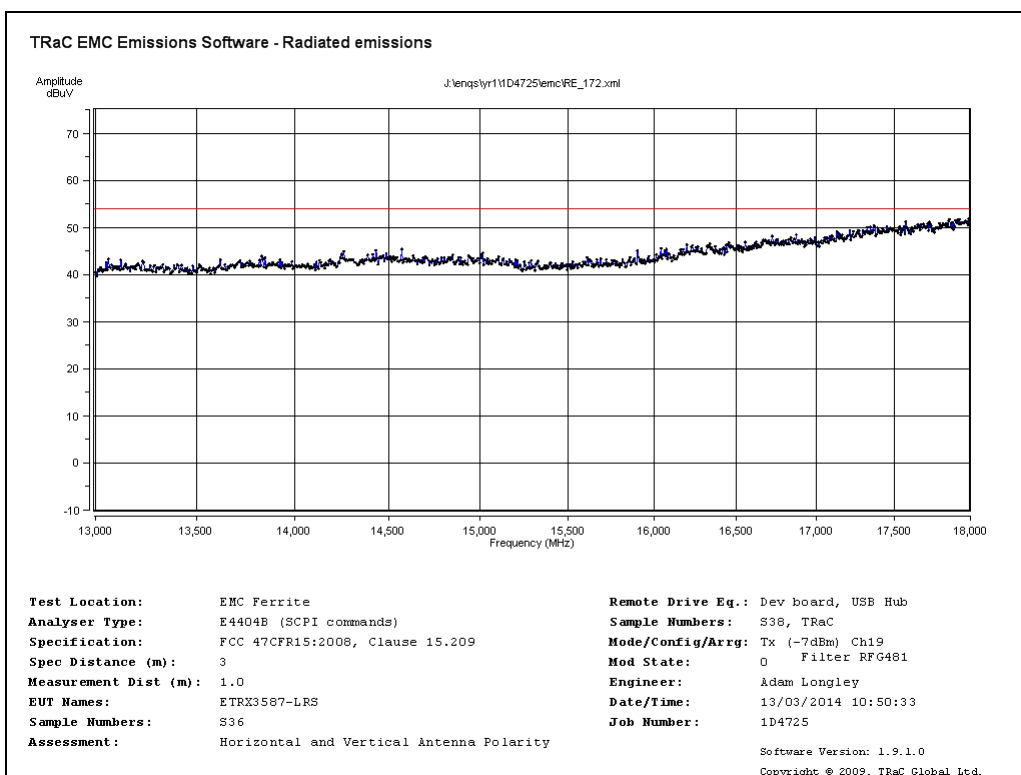

Radiated Transmitter Emissions Channel 19 2445MHz (15.209) Chip Antenna  
13GHz -18GHz

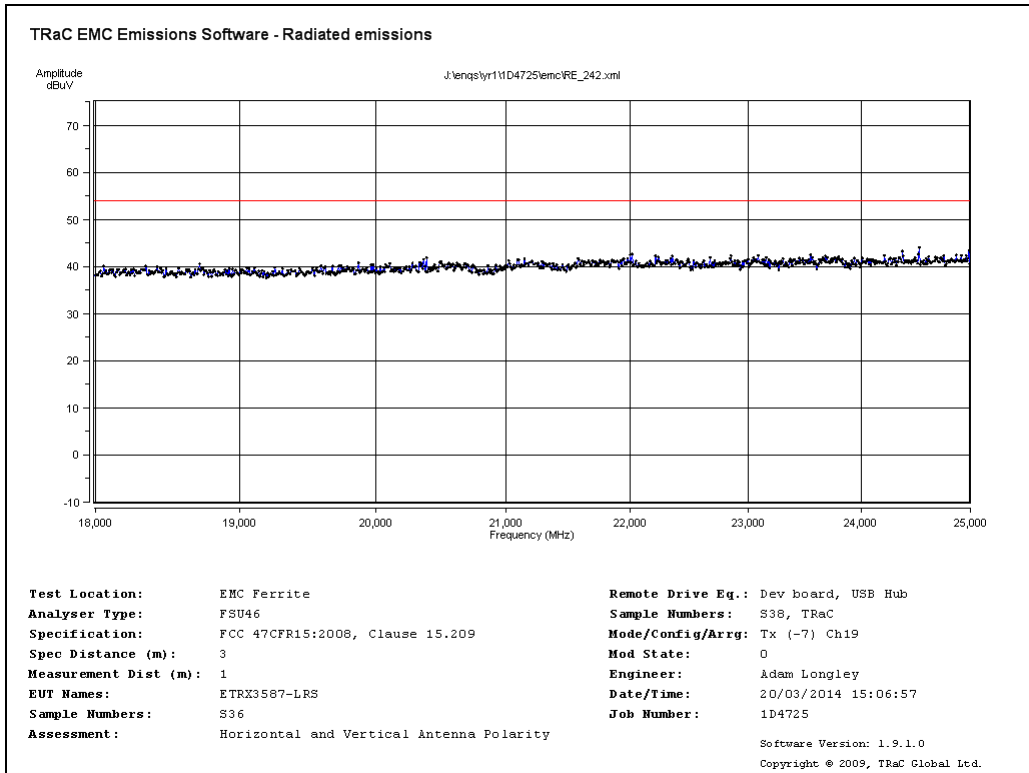

Radiated Transmitter Emissions Channel 19 2445MHz (15.209) Chip Antenna  
18GHz -25GHz

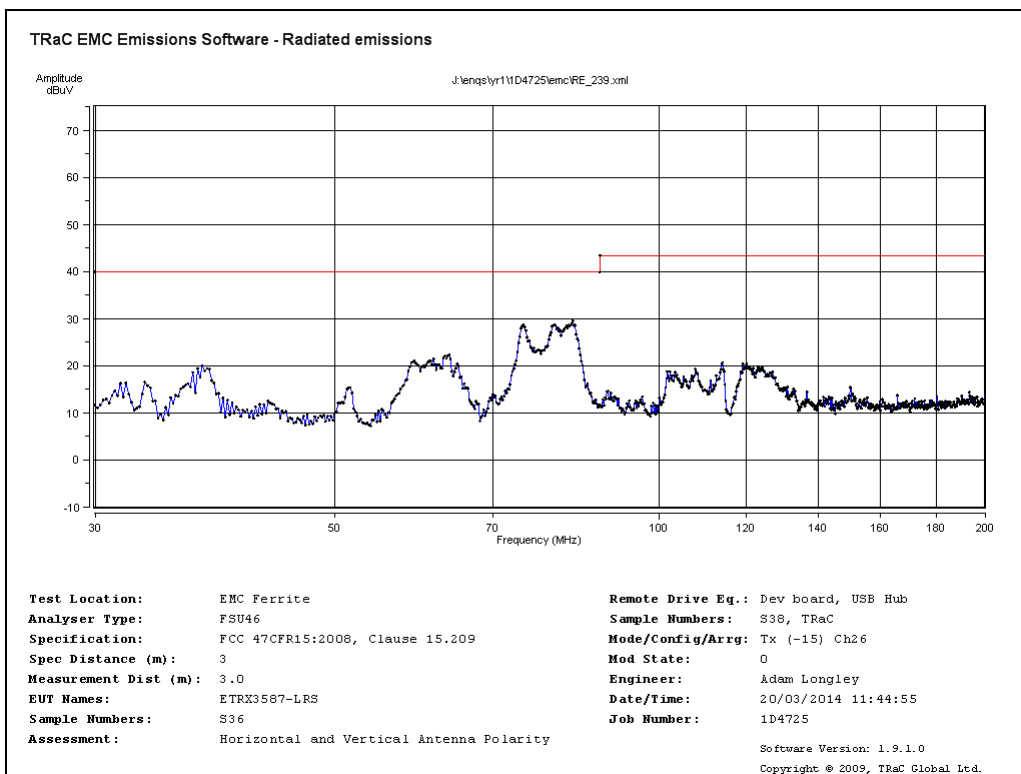

Radiated Transmitter Emissions Channel 26 2480MHz (15.209) Chip Antenna  
30MHz-200MHz

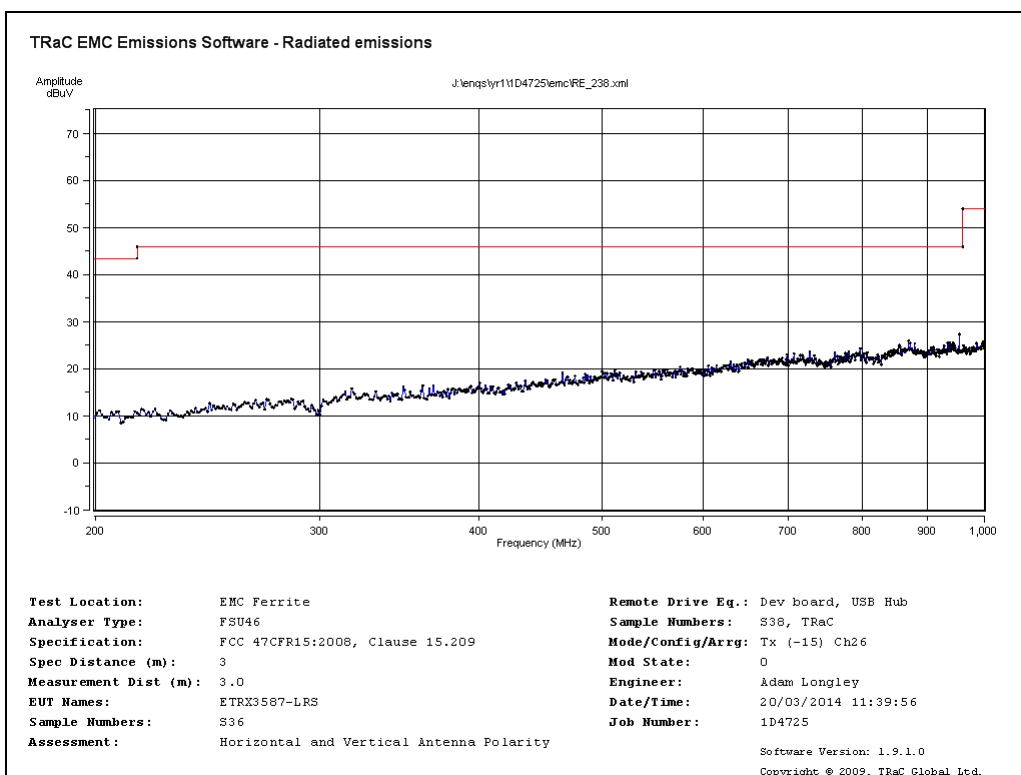

Radiated Transmitter Emissions Channel 26 2480MHz (15.209) Chip Antenna  
200MHz-1GHz

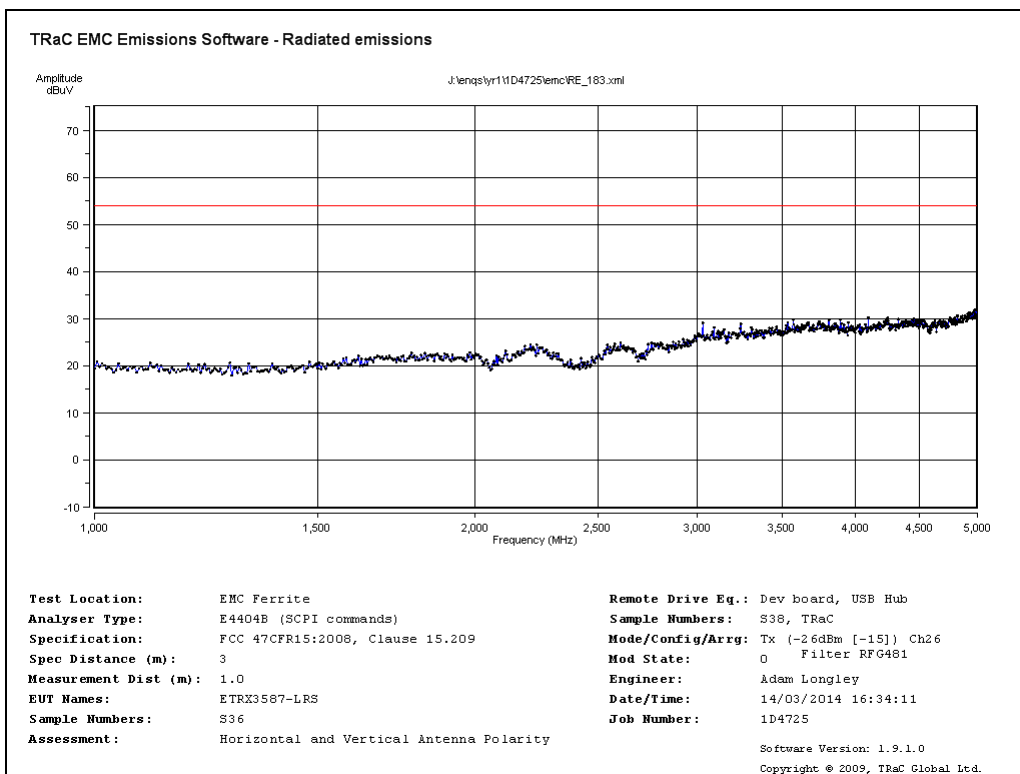

Radiated Transmitter Emissions Channel 26 2480MHz (15.209) Chip Antenna  
1GHz-5GHz

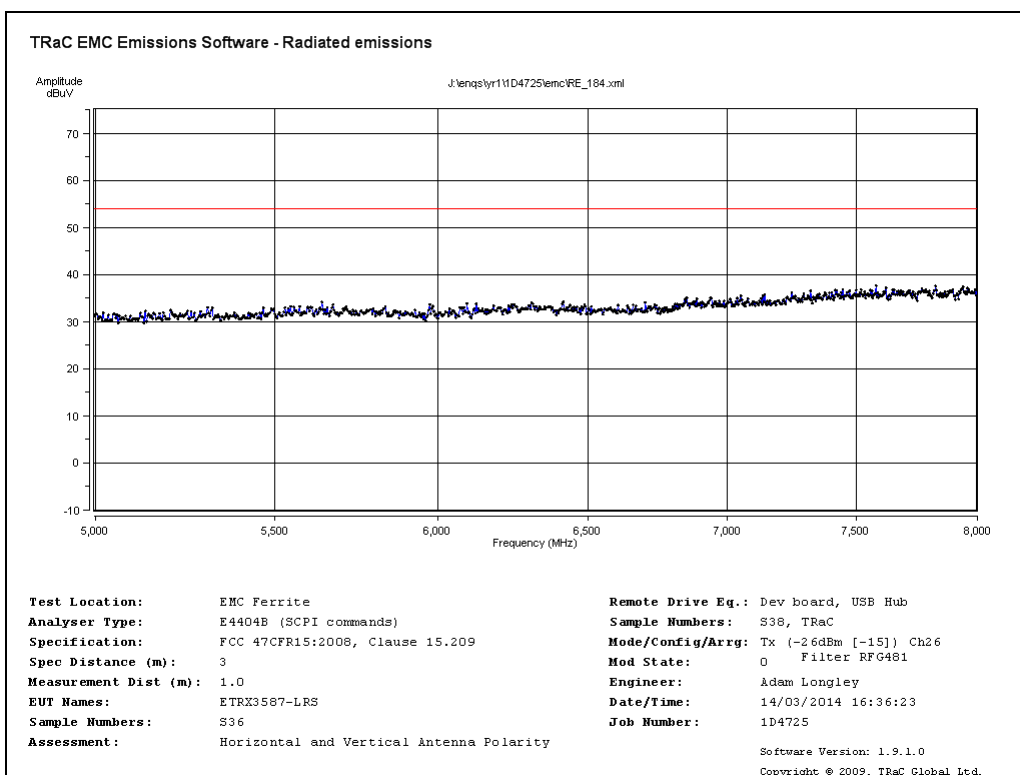

Radiated Transmitter Emissions Channel 26 2480MHz (15.209) Chip Antenna  
5GHz-8GHz

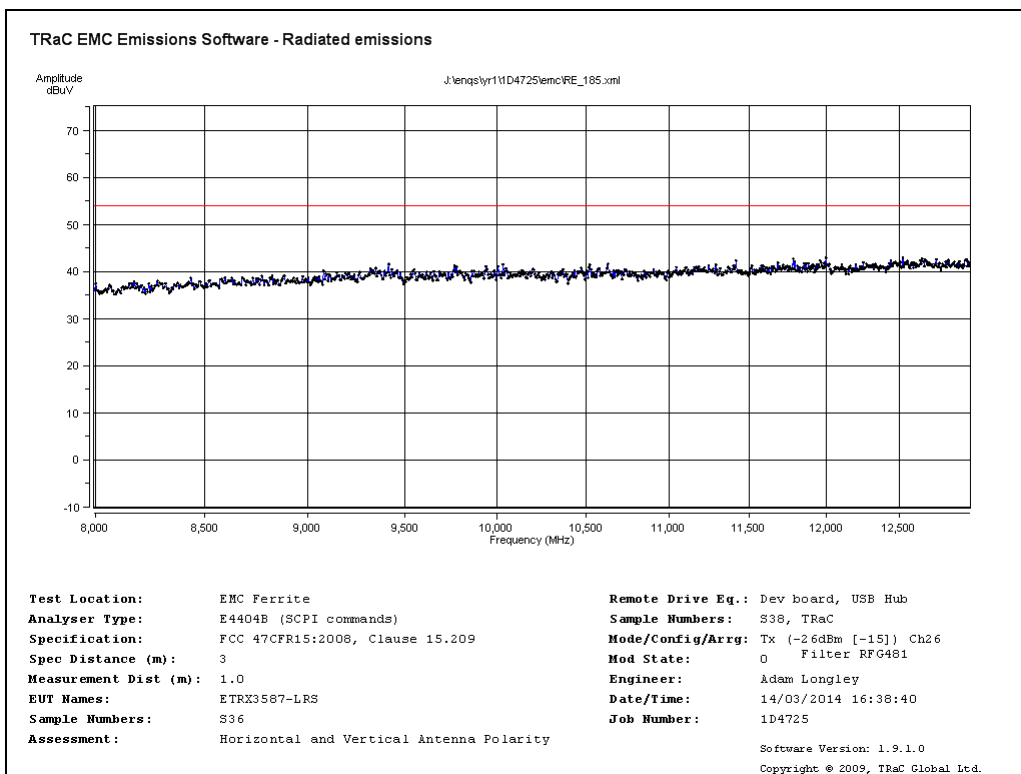

Radiated Transmitter Emissions Channel 26 2480MHz (15.209) Chip Antenna  
8GHz-13GHz

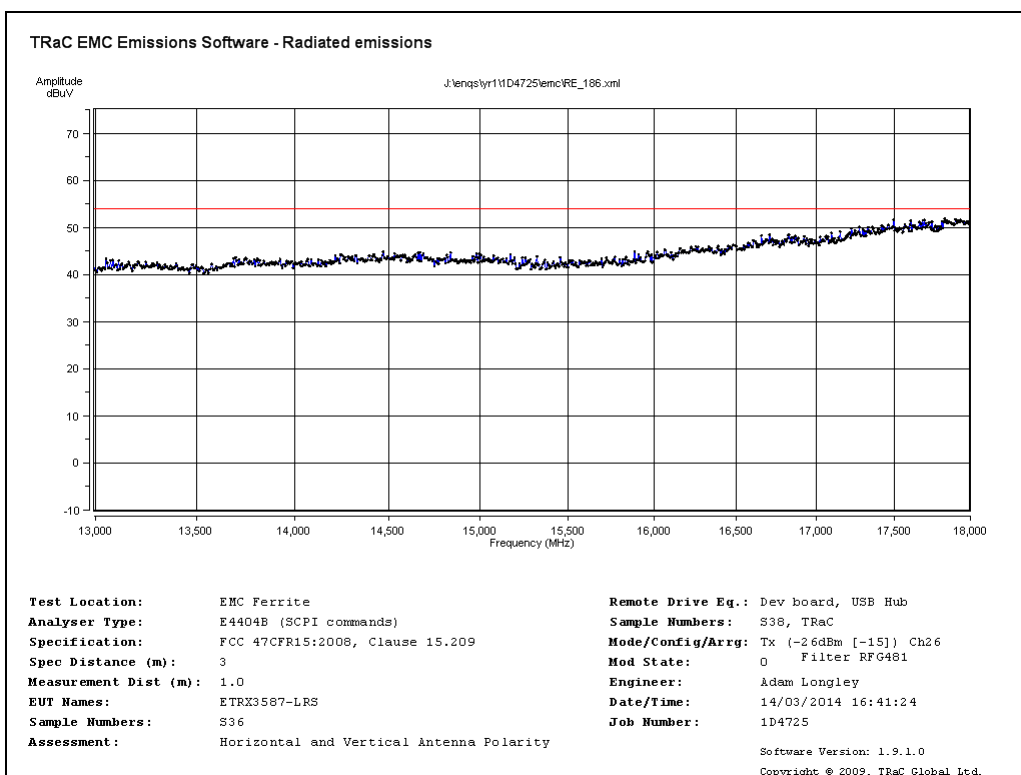

Radiated Transmitter Emissions Channel 26 2480MHz (15.209) Chip Antenna  
13GHz-18GHz



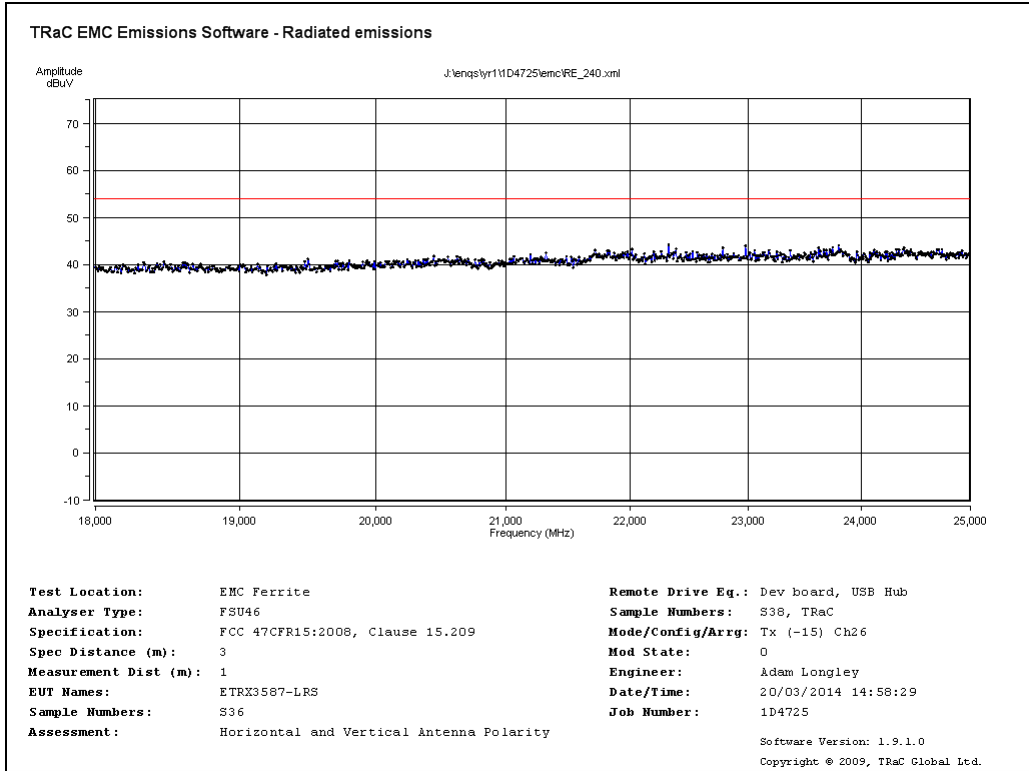

Radiated Transmitter Emissions Channel 26 2480MHz (15.209) Chip Antenna  
18GHz-25GHz

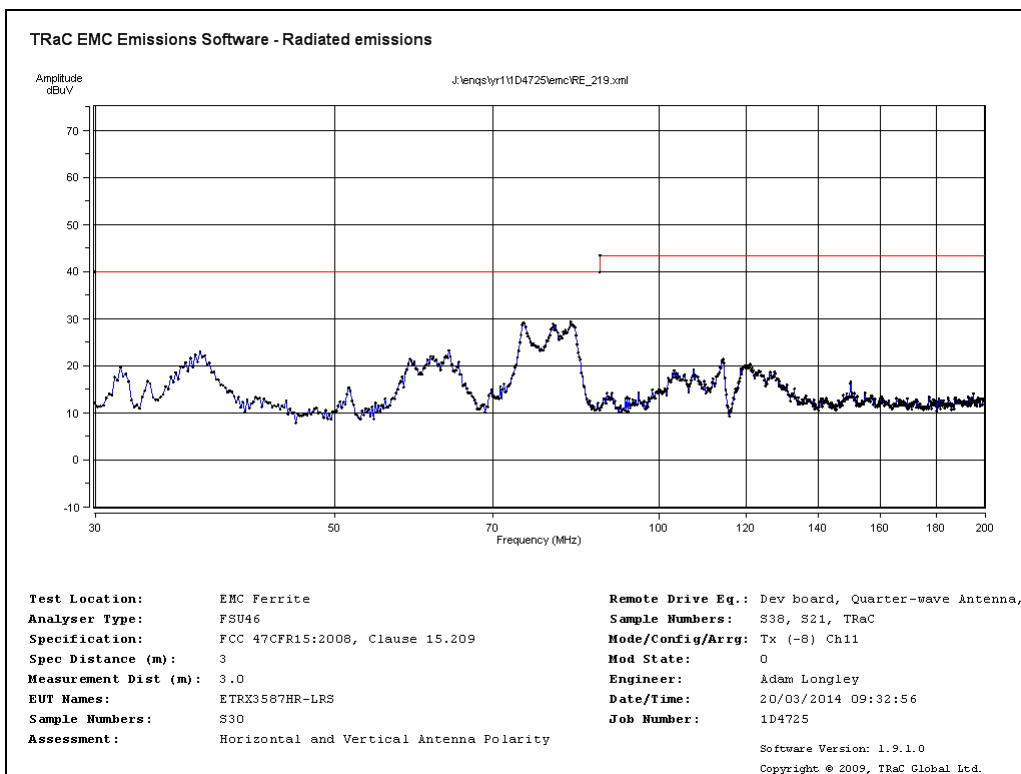

Radiated Transmitter Emissions Channel 11 2405MHz (15.209) Quarter-wave Antenna  
30MHz -200MHz

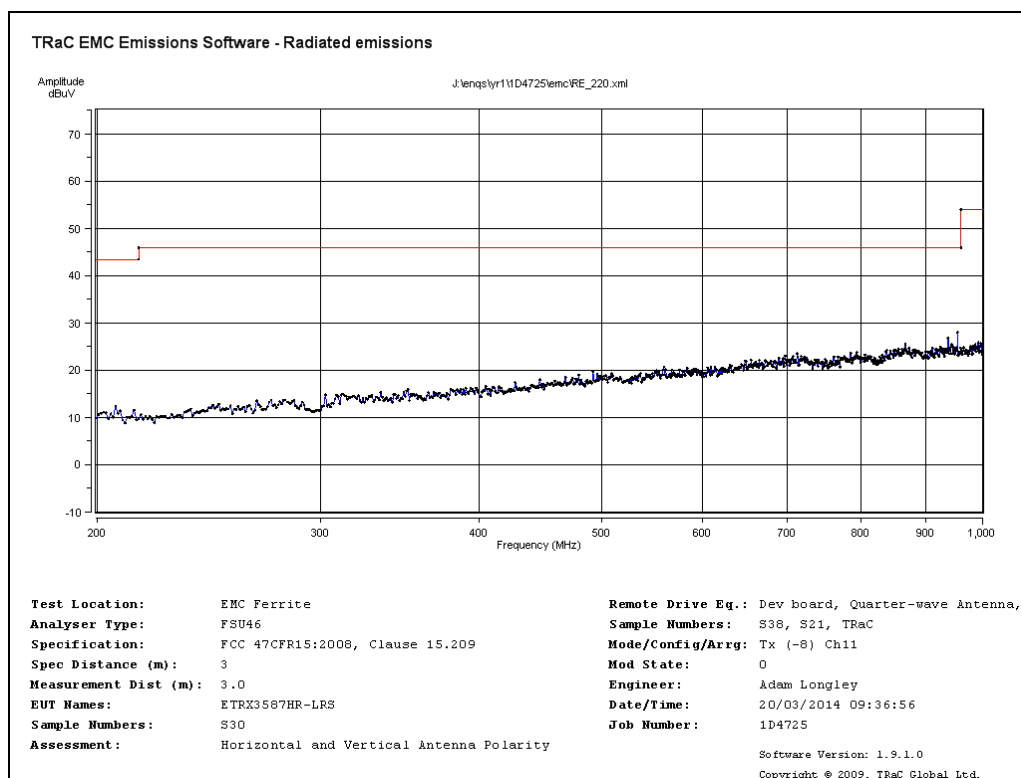

Radiated Transmitter Emissions Channel 11 2405MHz (15.209) Quarter-wave Antenna  
200MHz - 1GHz

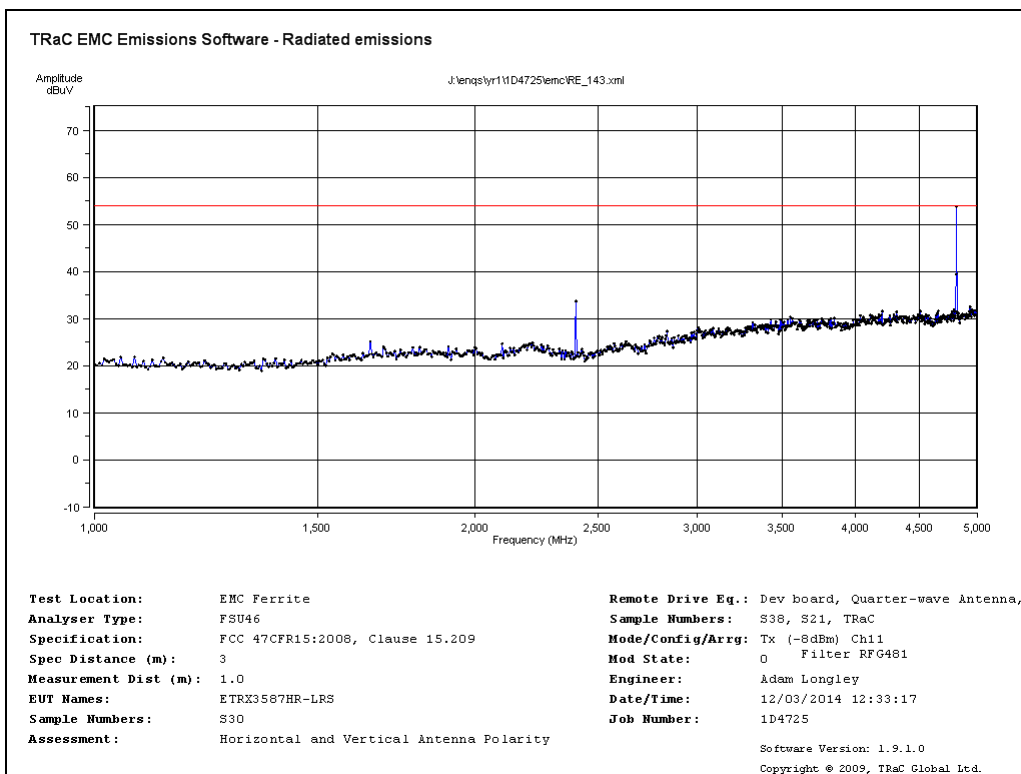

Radiated Transmitter Emissions Channel 11 2405MHz (15.209) Quarter-wave Antenna  
1GHz- 5GHz

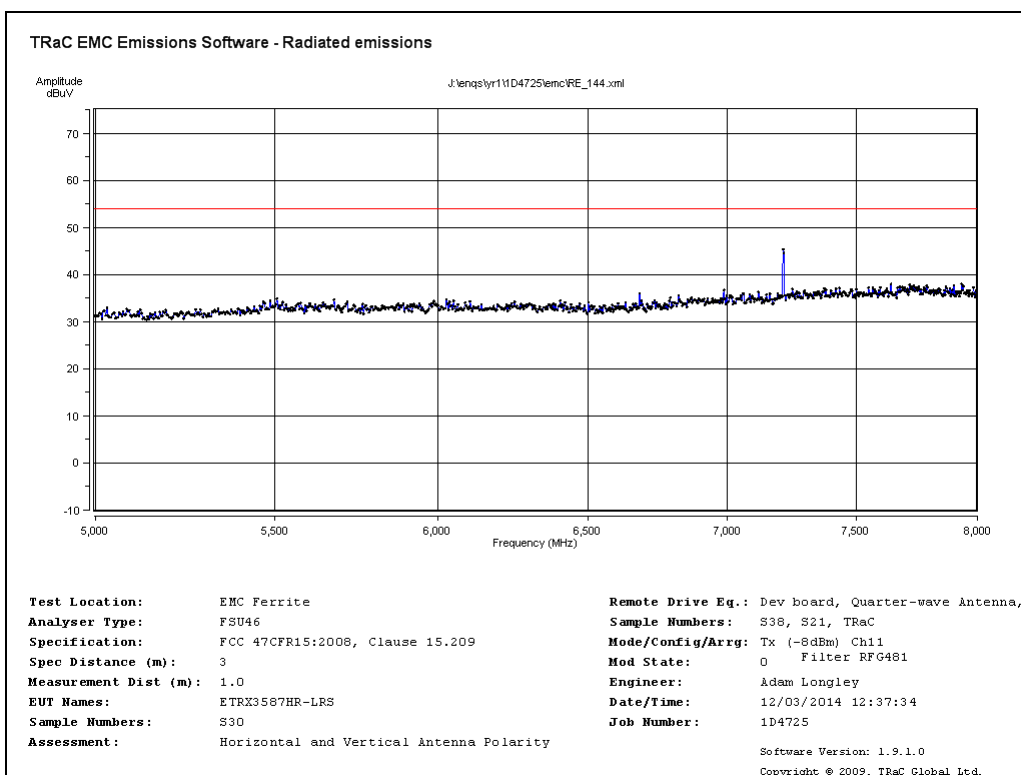

Radiated Transmitter Emissions Channel 11 2405MHz (15.209) Quarter-wave Antenna  
5GHz- 8GHz

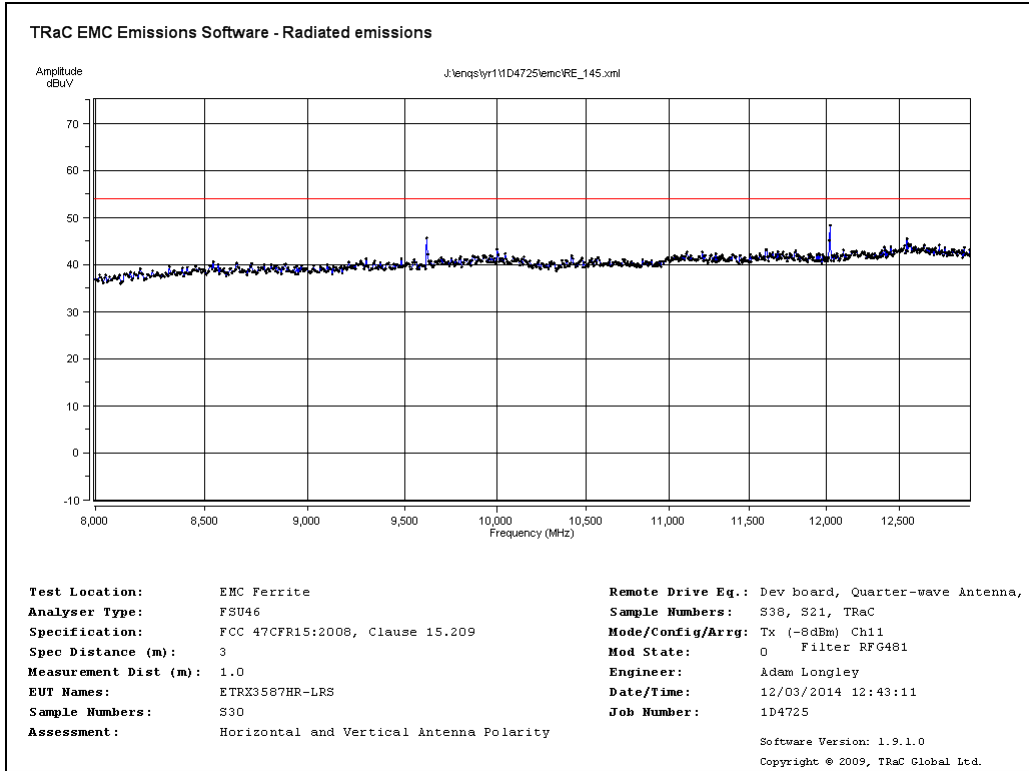

Radiated Transmitter Emissions Channel 11 2405MHz (15.209) Quarter-wave Antenna  
8GHz- 13GHz

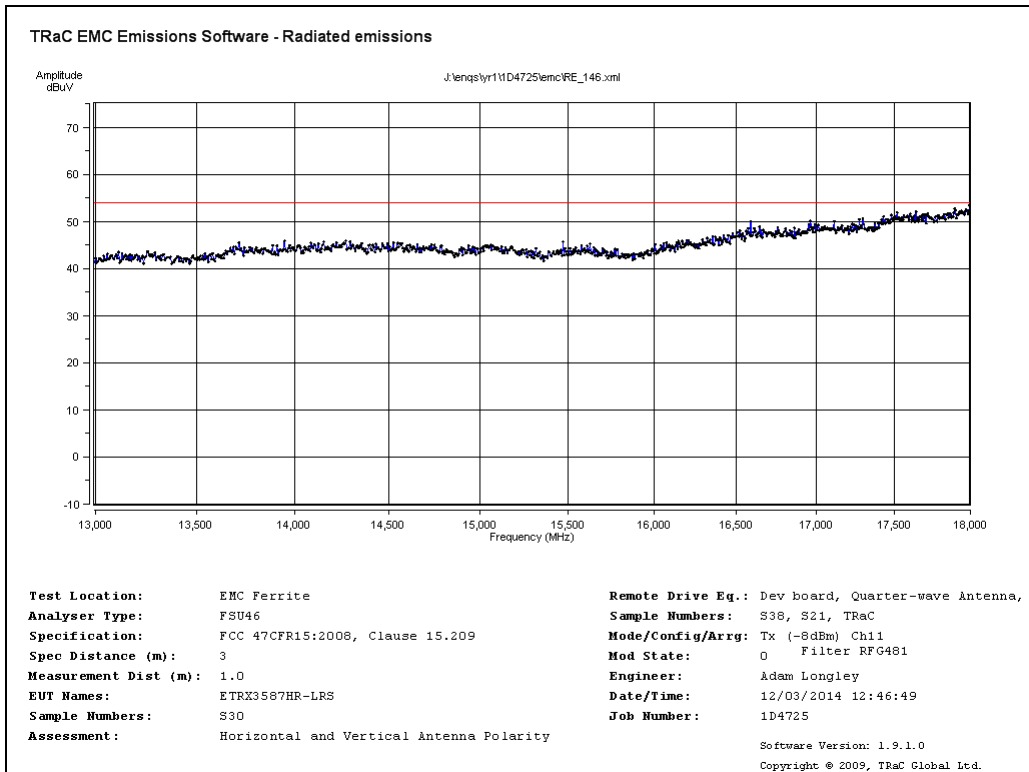

Radiated Transmitter Emissions Channel 11 2405MHz (15.209) Quarter-wave Antenna  
13GHz- 18GHz

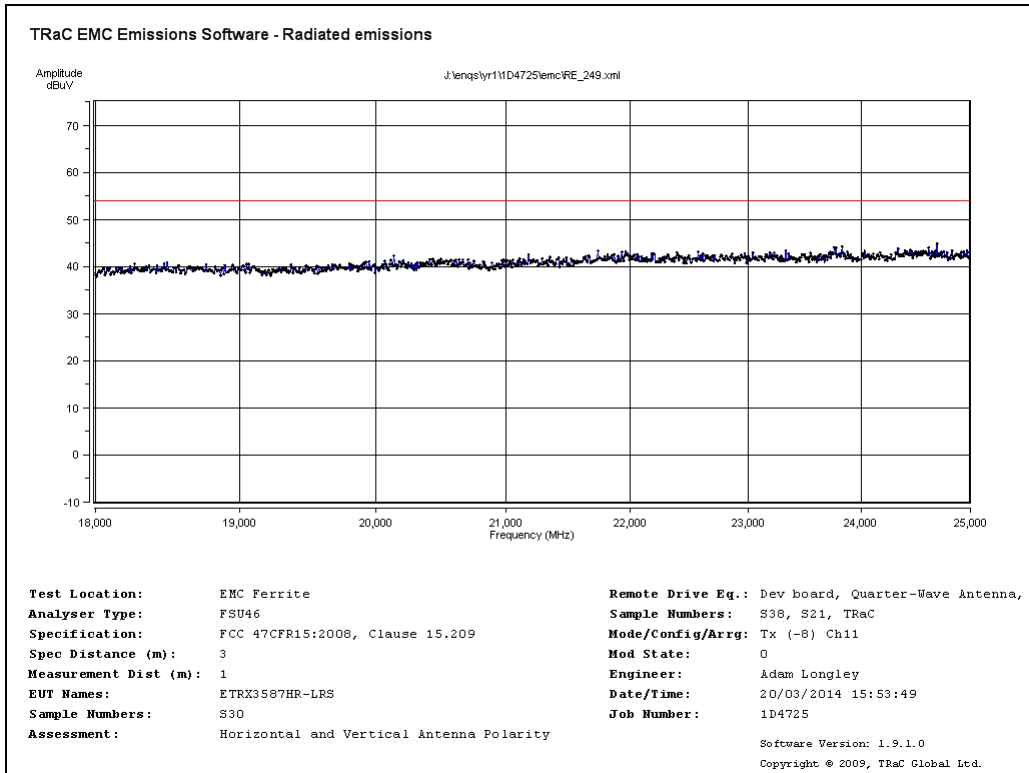

Radiated Transmitter Emissions Channel 11 2405MHz (15.209) Quarter-wave Antenna  
18GHz- 25GHz

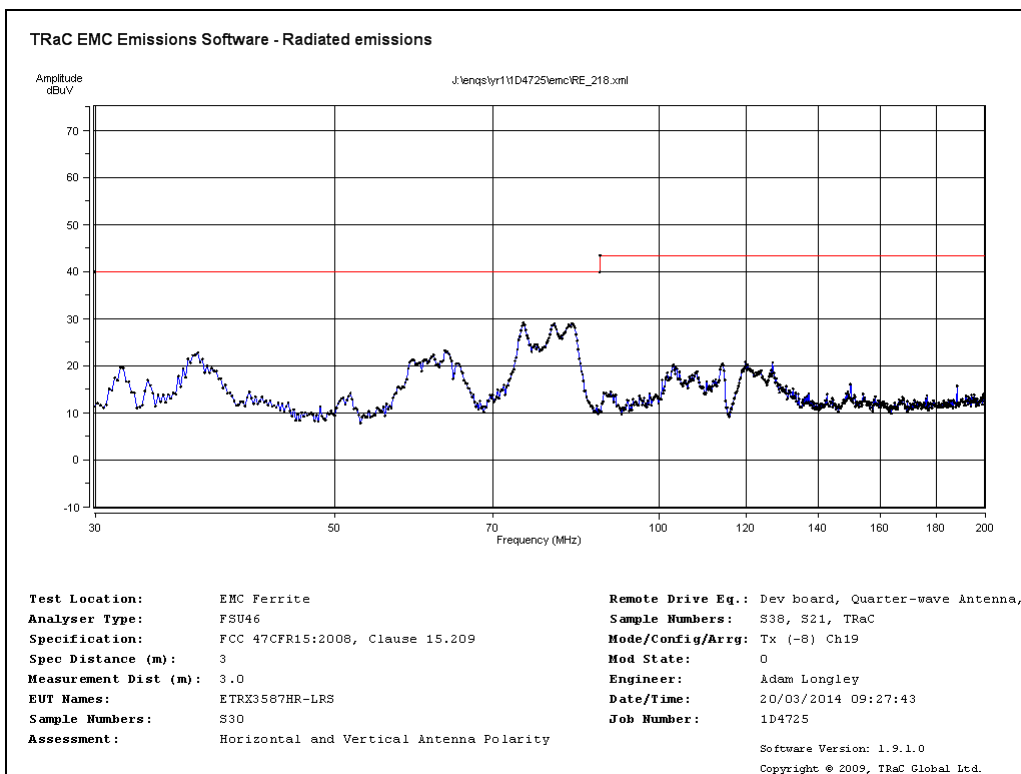

Radiated Transmitter Emissions Channel 19 2445MHz (15.209) Quarter-wave Antenna  
30MHz -200MHz

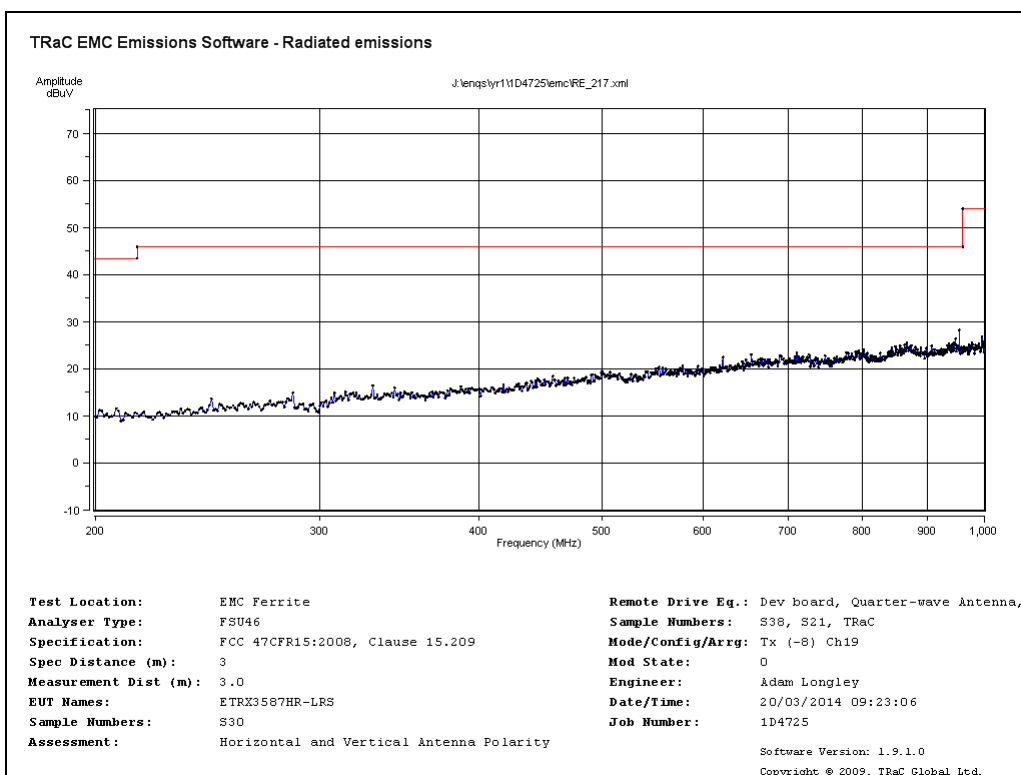

Radiated Transmitter Emissions Channel 19 2445MHz (15.209) Quarter-wave Antenna  
200MHz -1GHz

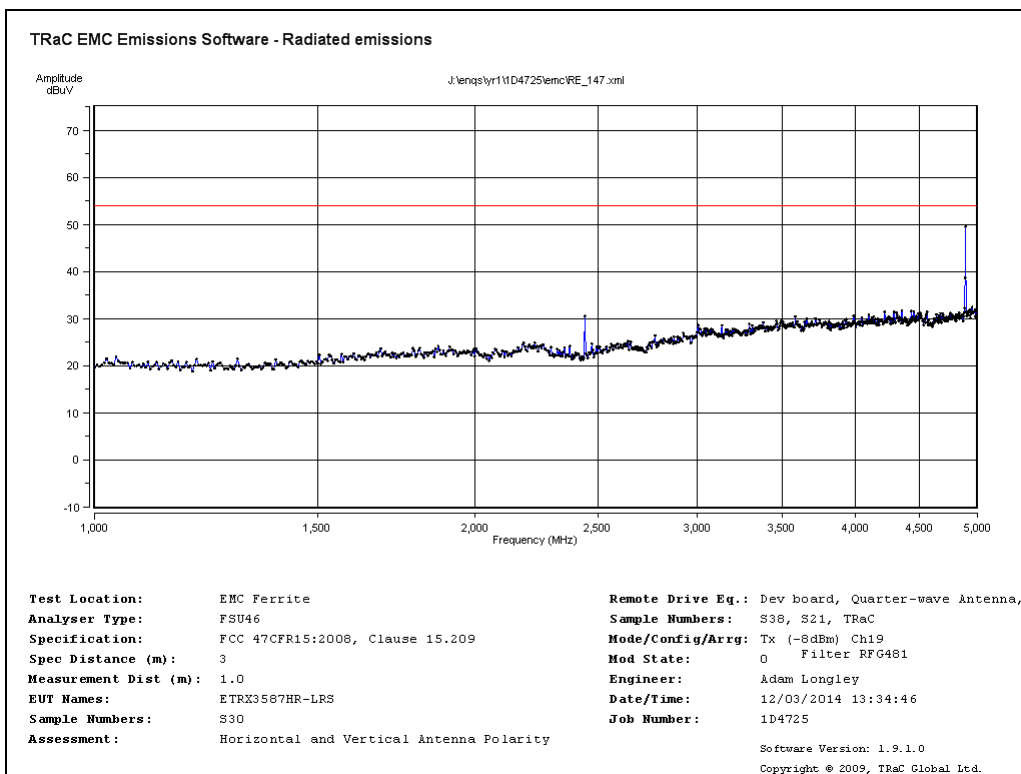

Radiated Transmitter Emissions Channel 19 2445MHz (15.209) Quarter-wave Antenna  
1GHz -5GHz

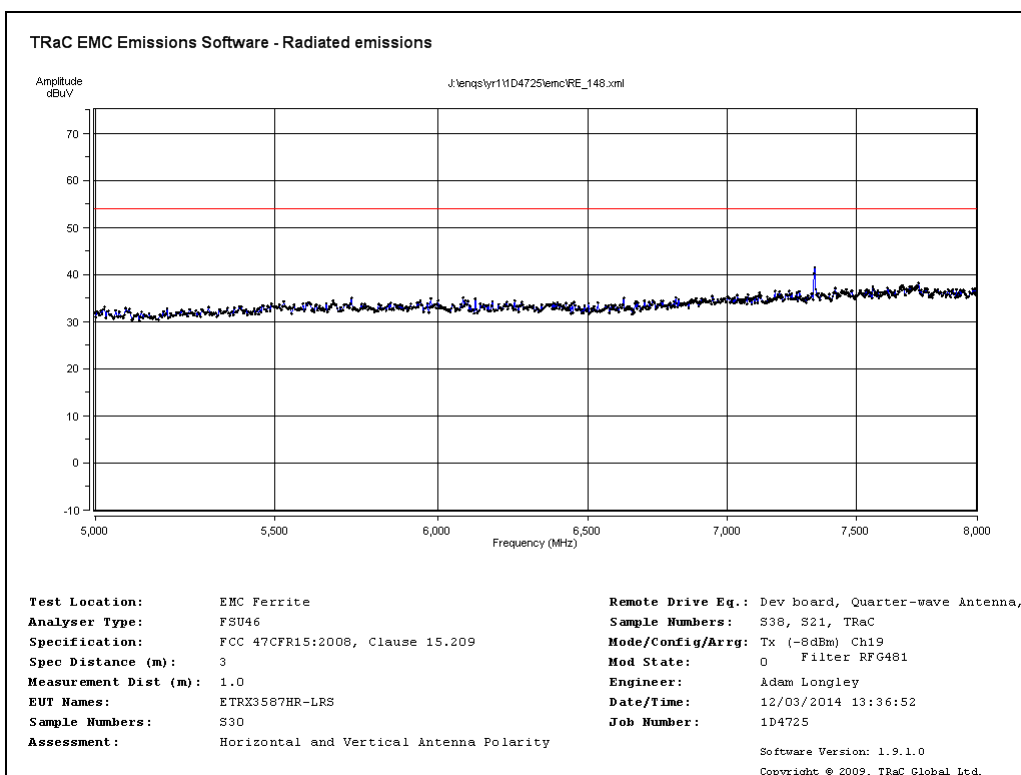

Radiated Transmitter Emissions Channel 19 2445MHz (15.209) Quarter-wave Antenna  
5GHz -8GHz

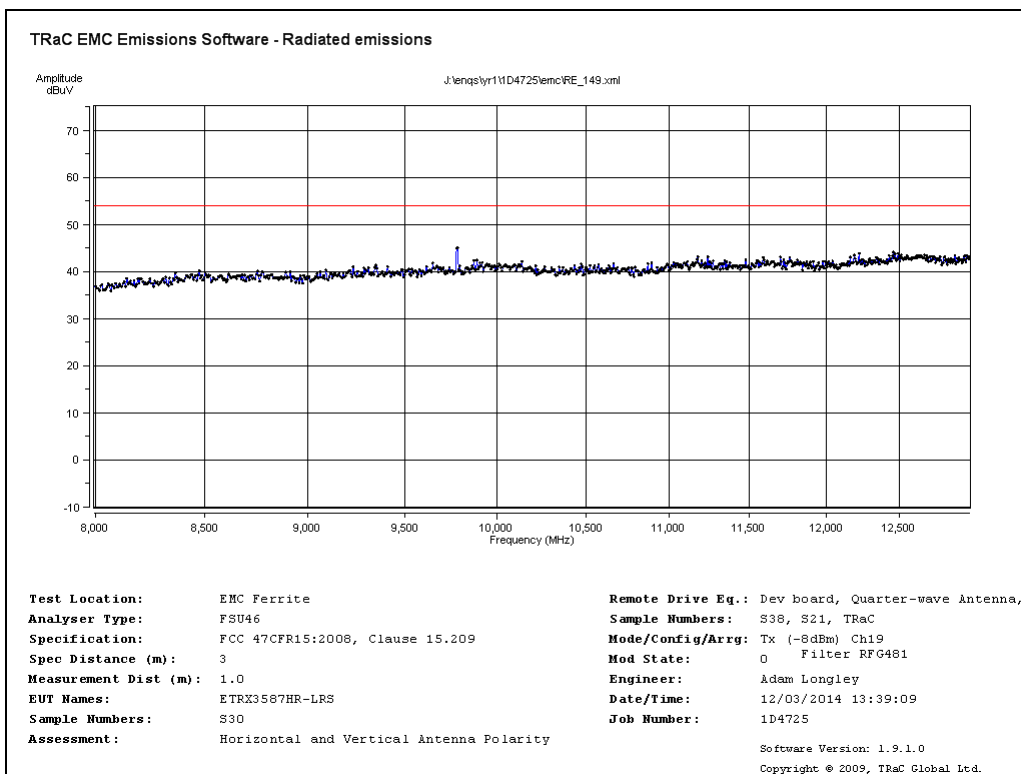

Radiated Transmitter Emissions Channel 19 2445MHz (15.209) Quarter-wave Antenna  
8GHz -13GHz

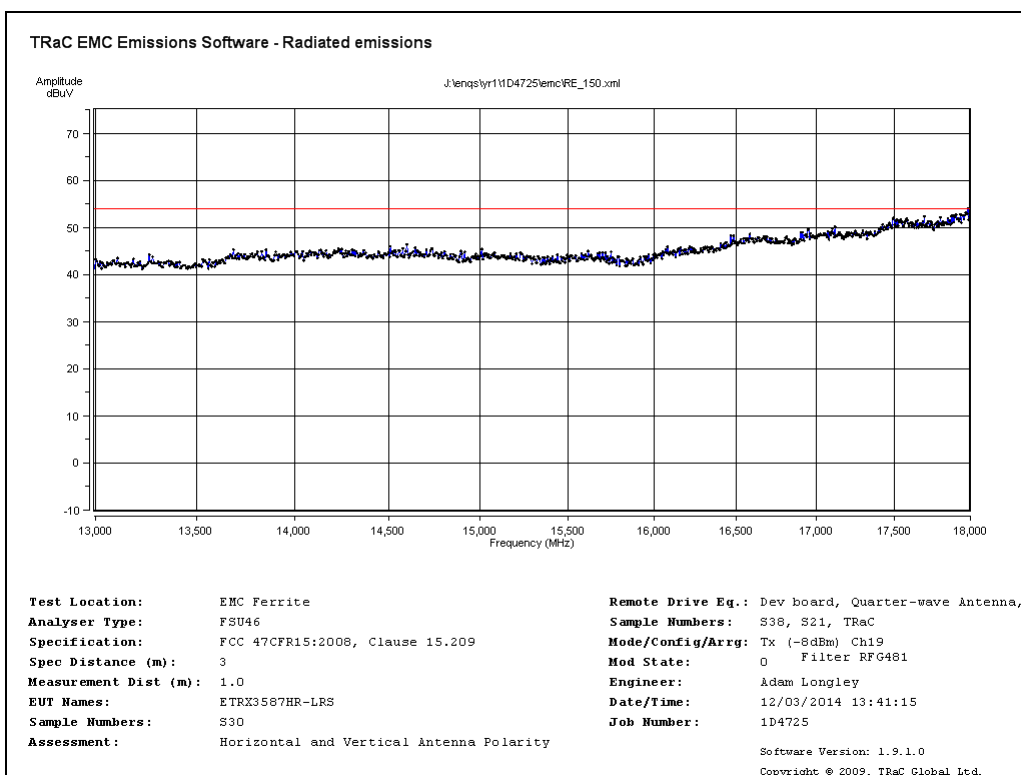

Radiated Transmitter Emissions Channel 19 2445MHz (15.209) Quarter-wave Antenna  
13GHz -18GHz



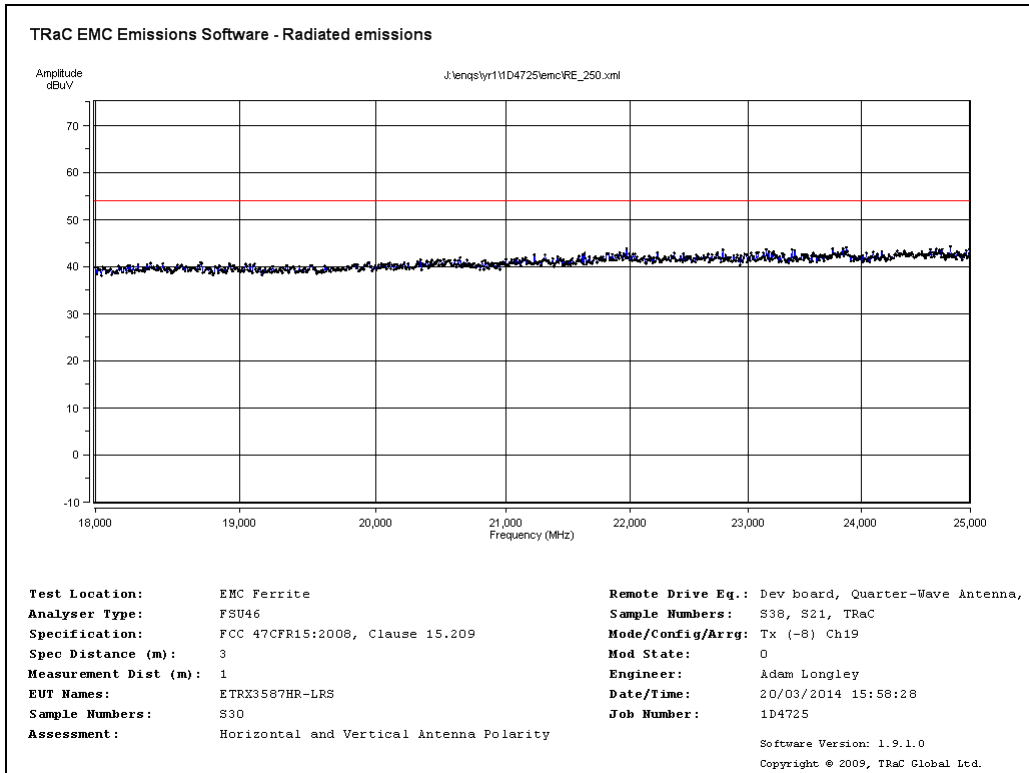

Radiated Transmitter Emissions Channel 19 2445MHz (15.209) Quarter-wave Antenna  
18GHz -25GHz

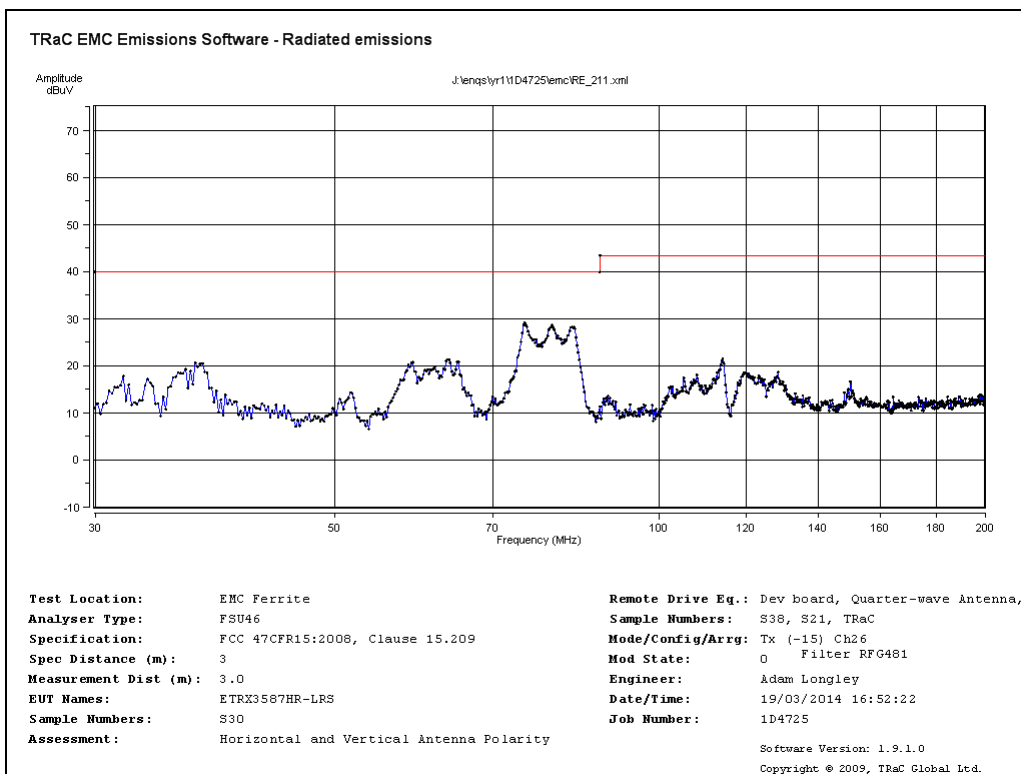

Radiated Transmitter Emissions Channel 26 2480MHz (15.209) Quarter-wave Antenna 30MHz-200MHz

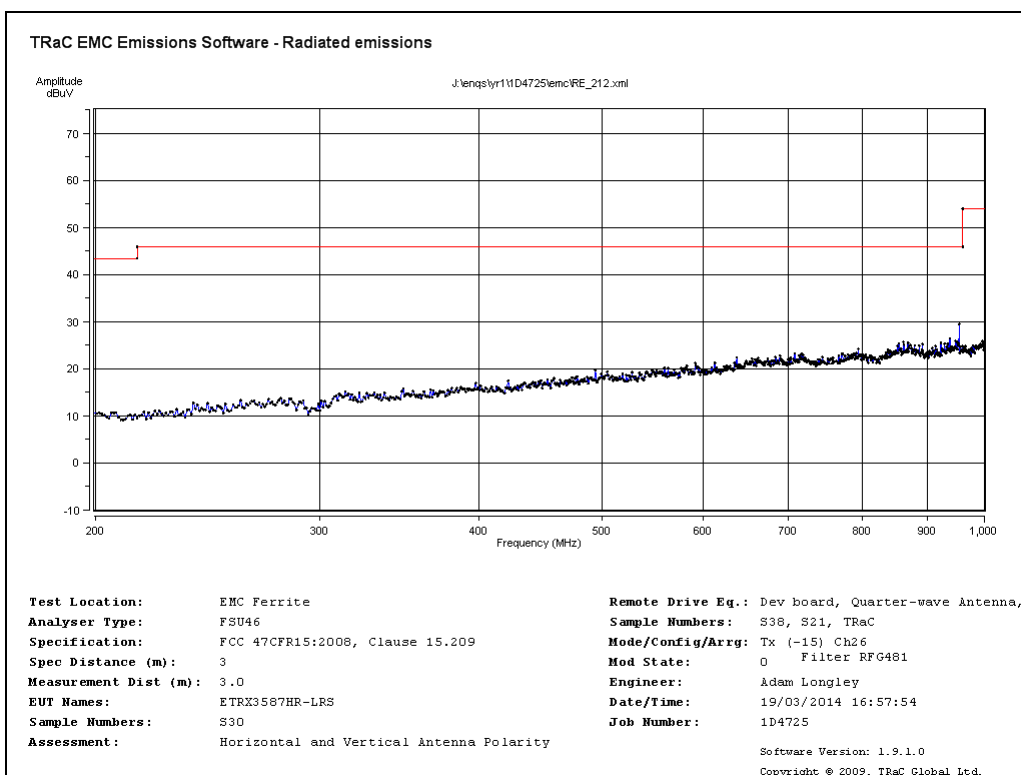

Radiated Transmitter Emissions Channel 26 2480MHz (15.209) Quarter-wave Antenna 200MHz-1GHz

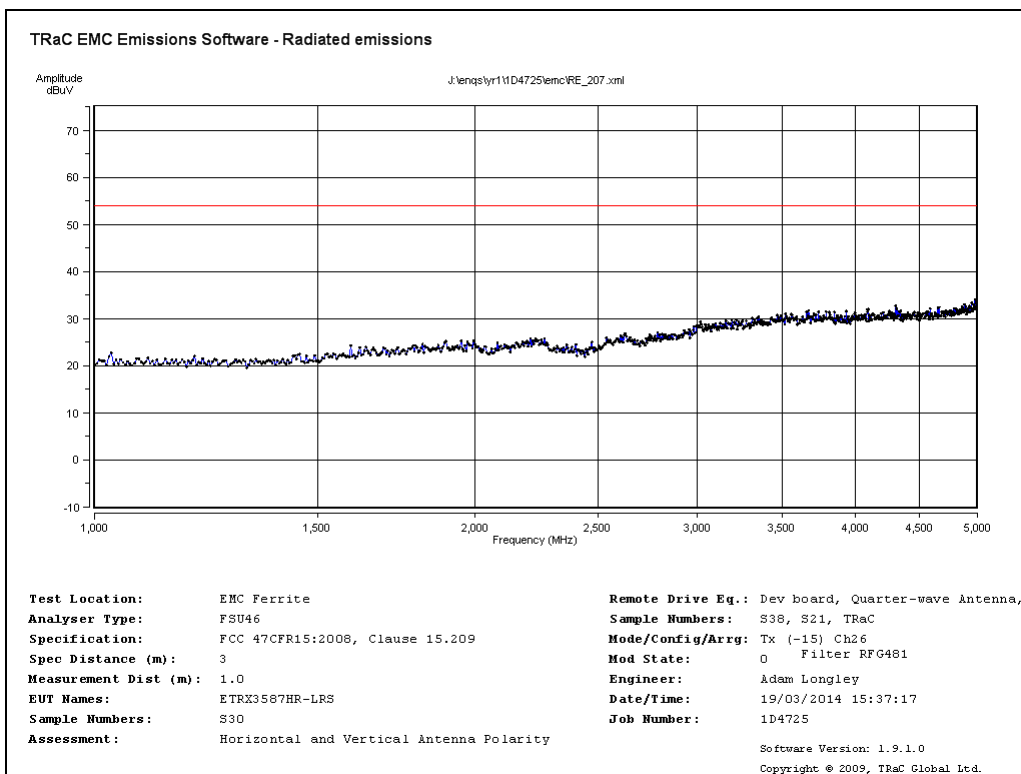

Radiated Transmitter Emissions Channel 26 2480MHz (15.209) Quarter-wave Antenna  
1GHz-5GHz

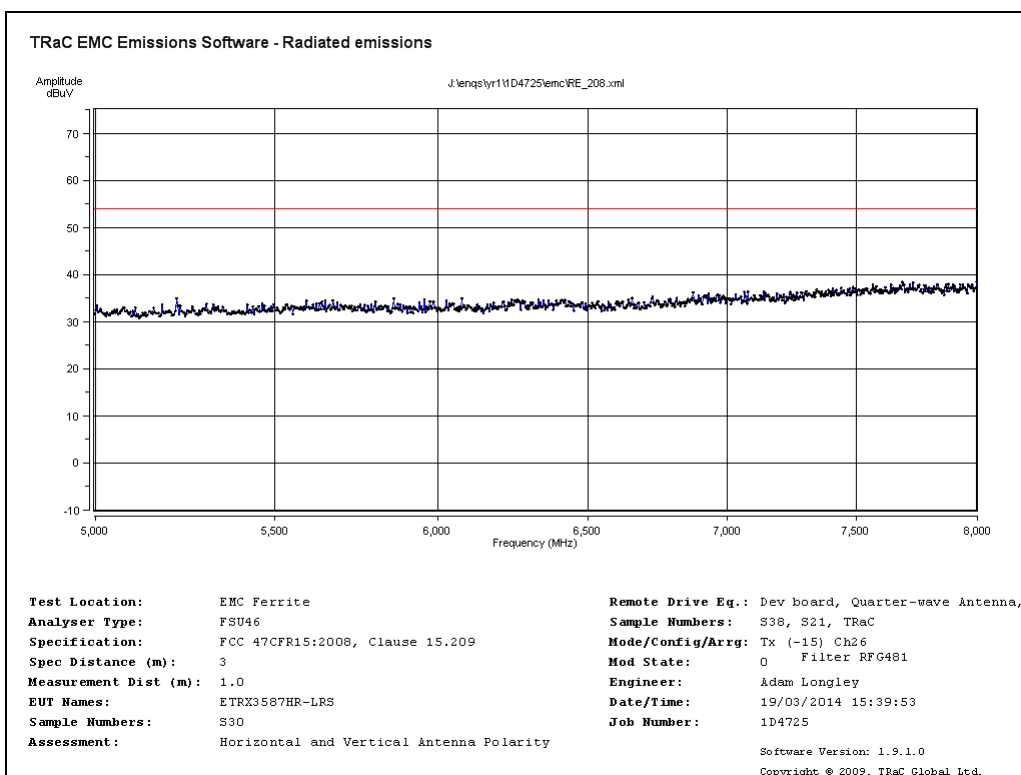

Radiated Transmitter Emissions Channel 26 2480MHz (15.209) Quarter-wave Antenna  
5GHz-8GHz

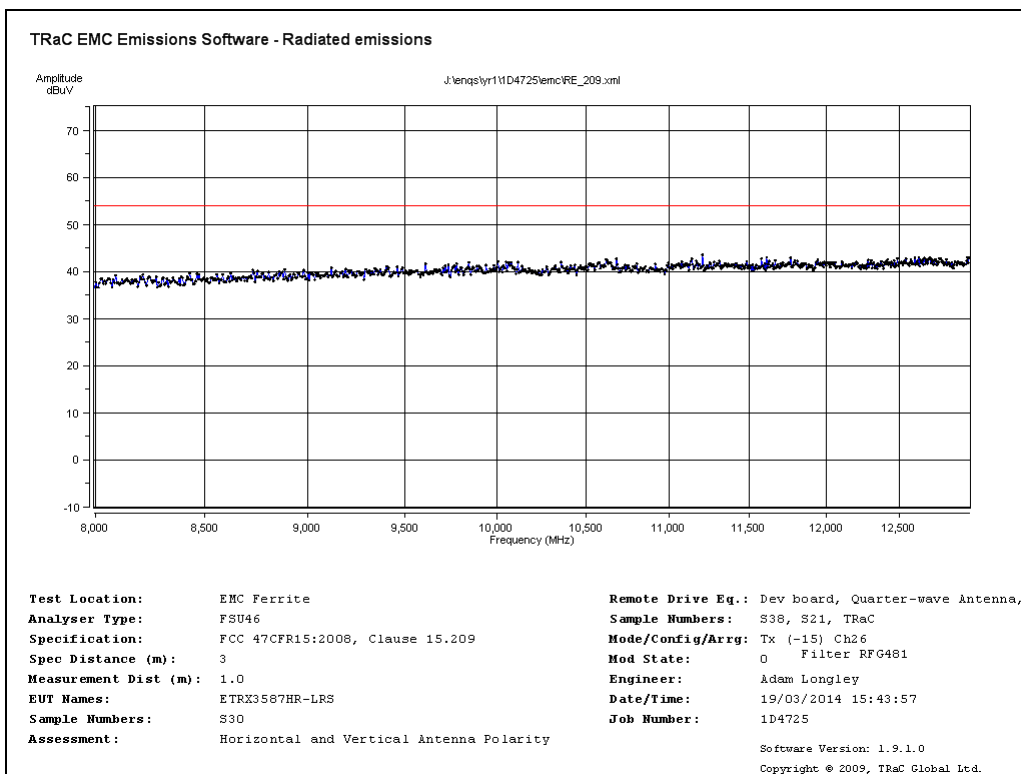

Radiated Transmitter Emissions Channel 26 2480MHz (15.209) Quarter-wave Antenna  
8GHz-13GHz

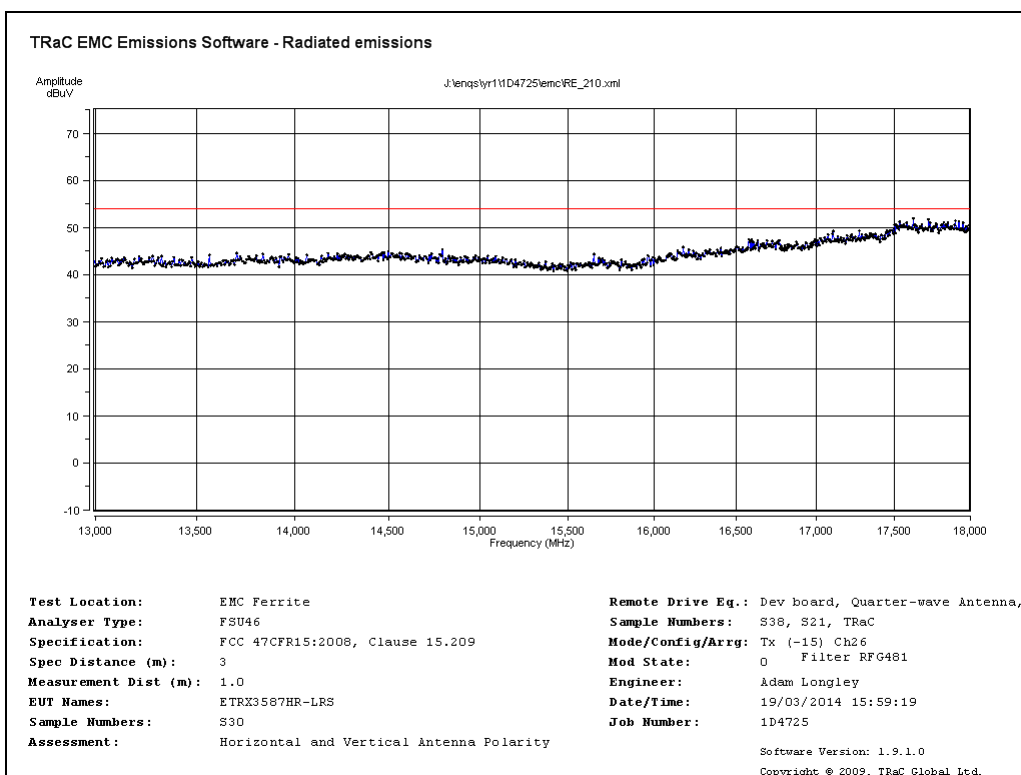

Radiated Transmitter Emissions Channel 26 2480MHz (15.209) Quarter-wave Antenna  
13GHz-18GHz

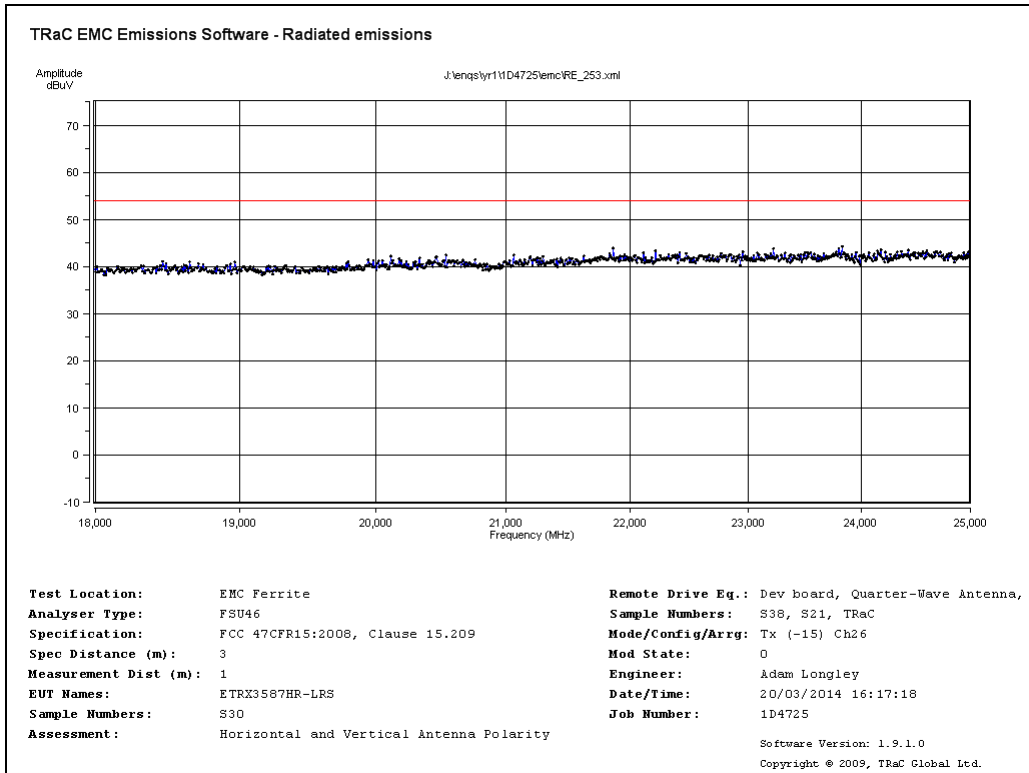

Radiated Transmitter Emissions Channel 26 2480MHz (15.209) Quarter-wave Antenna  
18GHz-25GHz

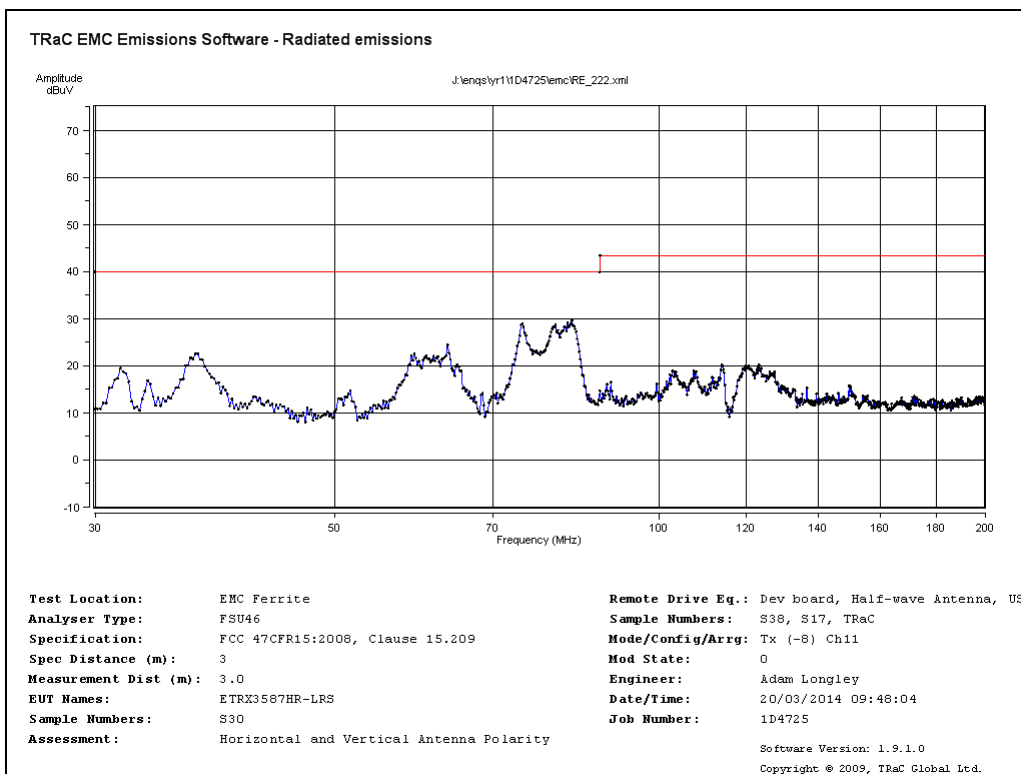

Radiated Transmitter Emissions Channel 11 2405MHz (15.209) Half-wave Antenna  
30MHz -200MHz

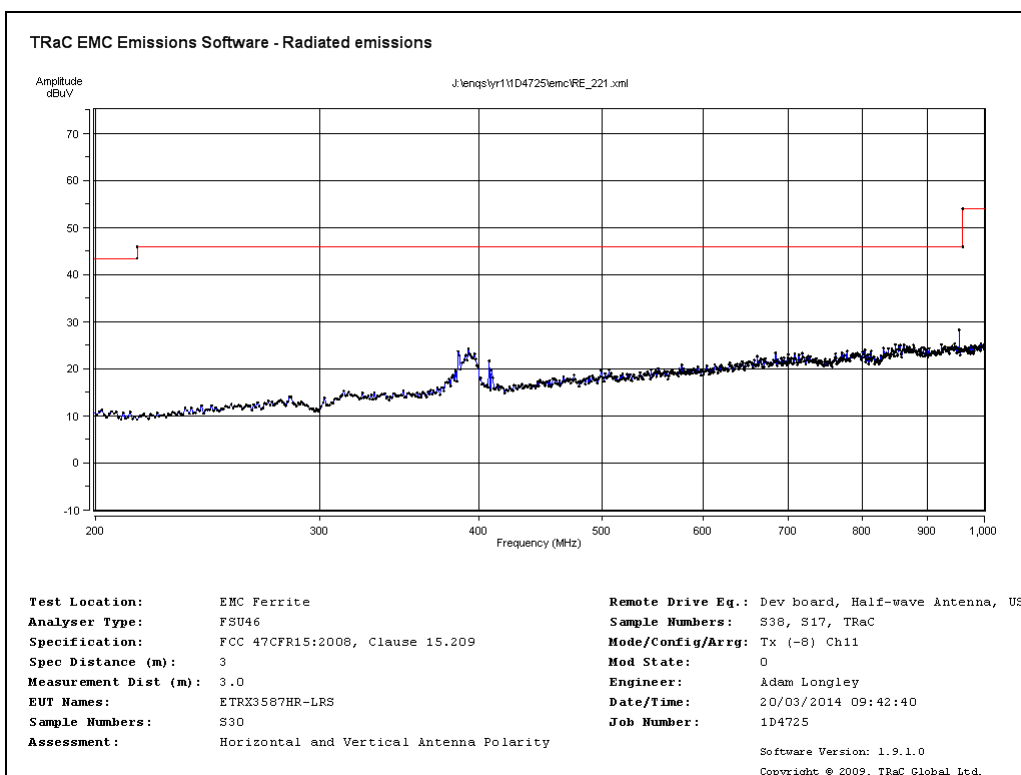

Radiated Transmitter Emissions Channel 11 2405MHz (15.209) Half-wave Antenna  
200MHz - 1GHz

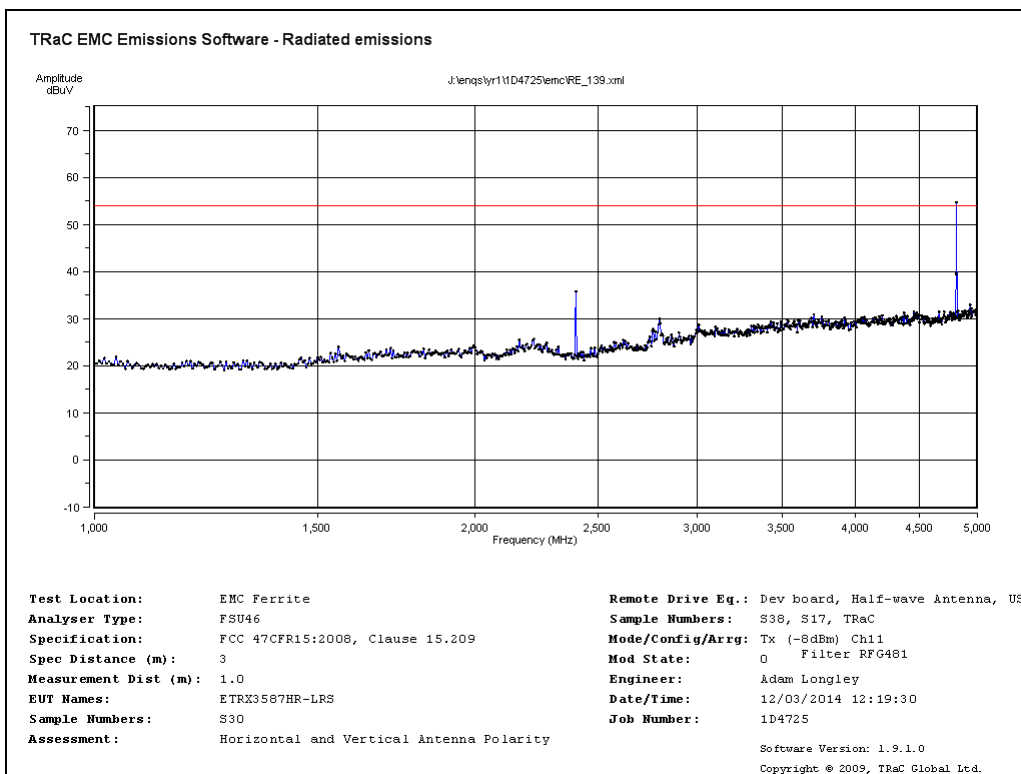

Radiated Transmitter Emissions Channel 11 2405MHz (15.209) Half-wave Antenna  
1GHz- 5GHz

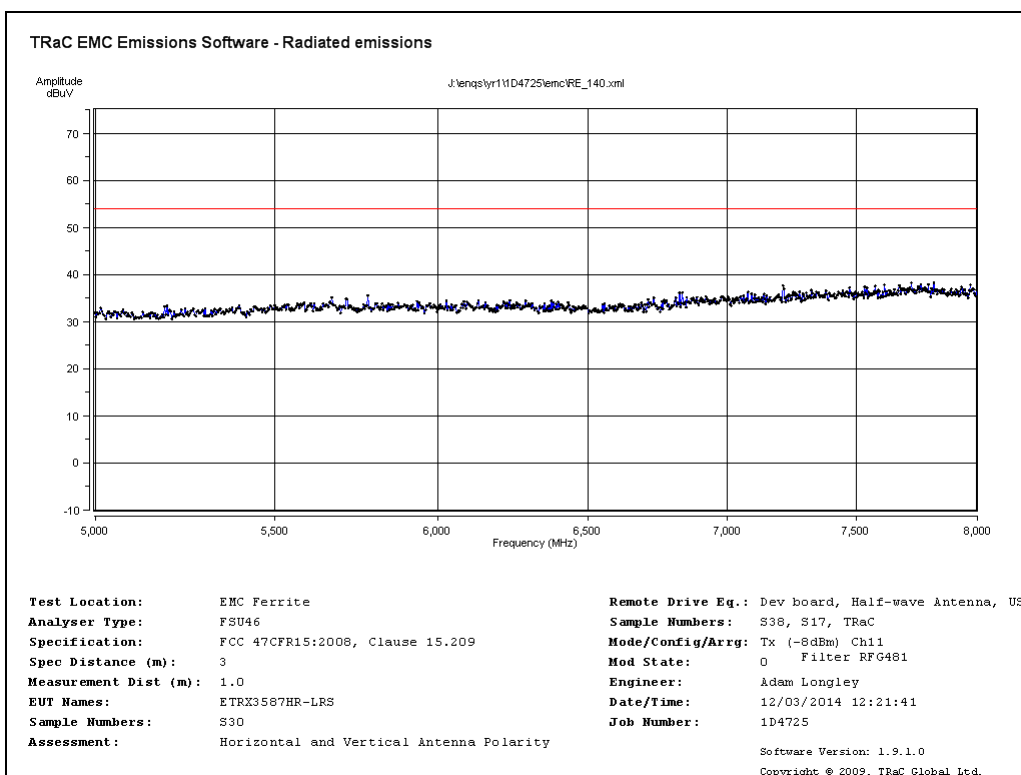

Radiated Transmitter Emissions Channel 11 2405MHz (15.209) Half-wave Antenna  
5GHz- 8GHz

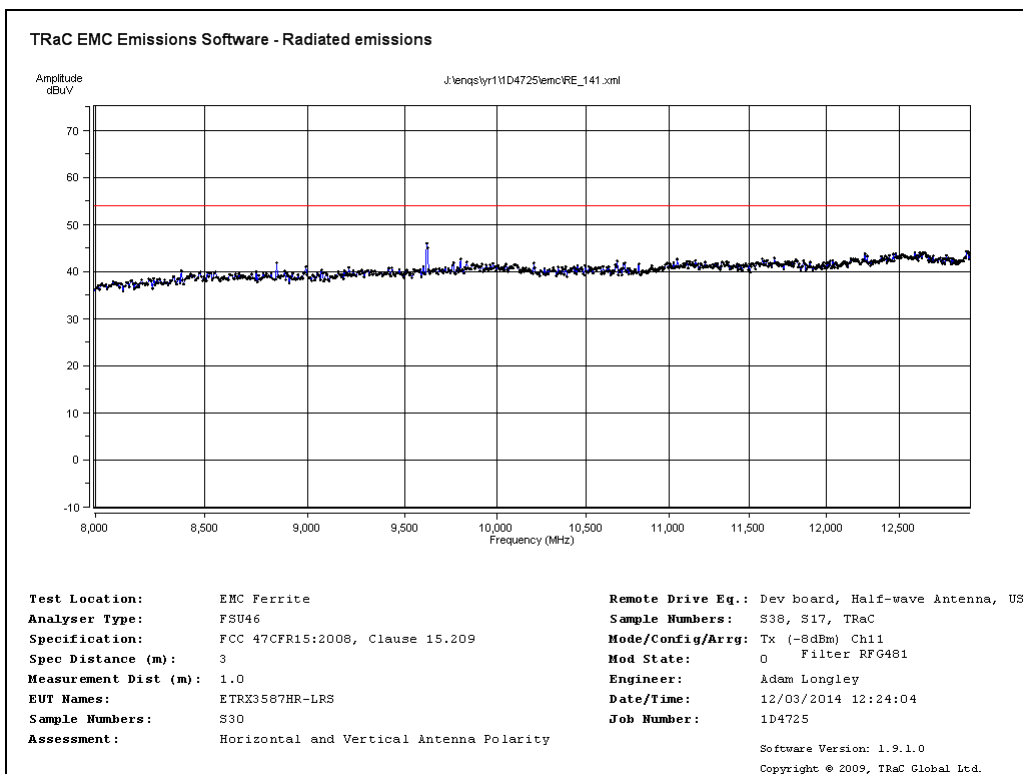

Radiated Transmitter Emissions Channel 11 2405MHz (15.209) Half-wave Antenna  
8GHz- 13GHz

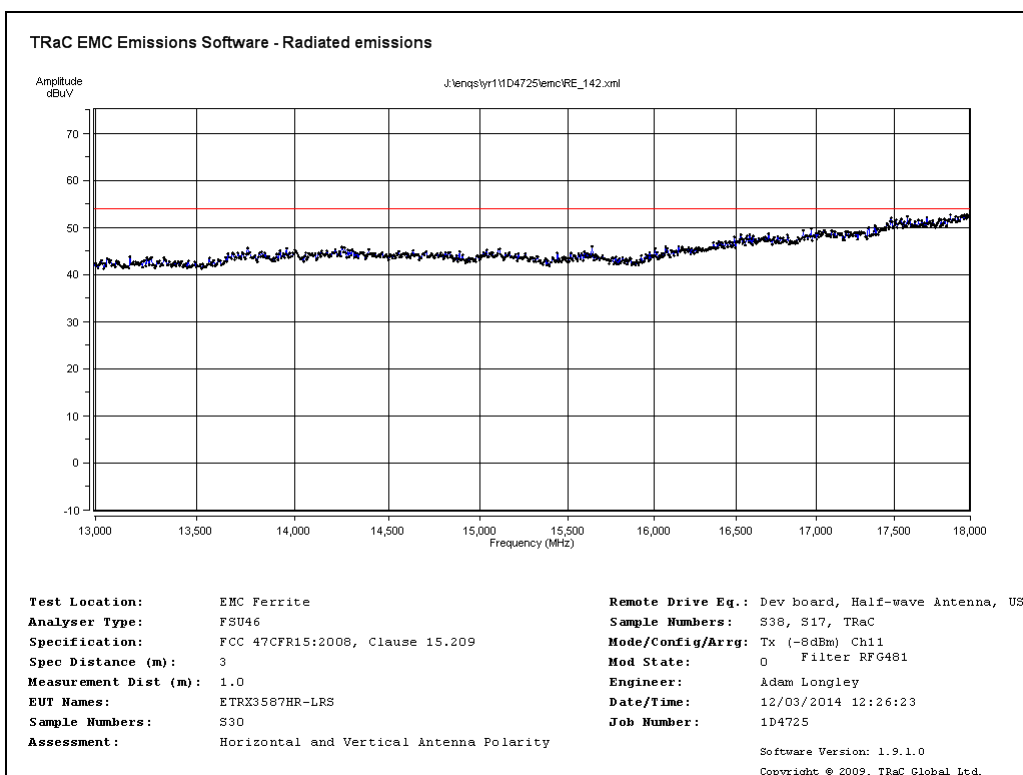

Radiated Transmitter Emissions Channel 11 2405MHz (15.209) Half-wave Antenna  
13GHz- 18GHz



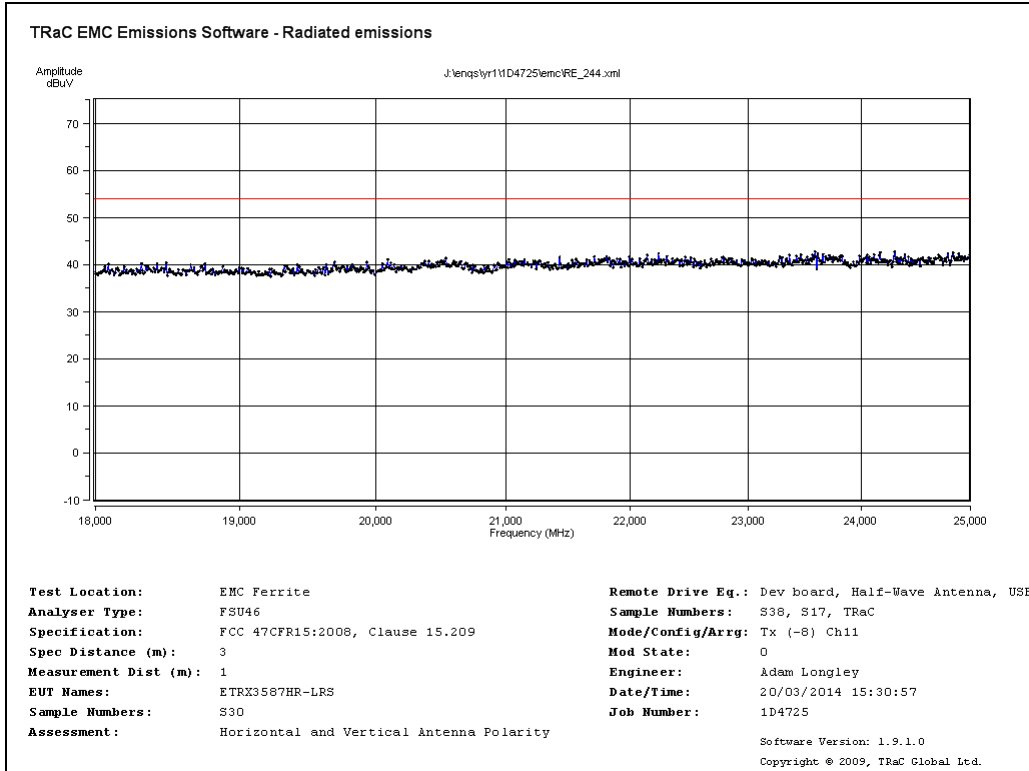

Radiated Transmitter Emissions Channel 11 2405MHz (15.209) Half-wave Antenna  
18GHz- 25GHz

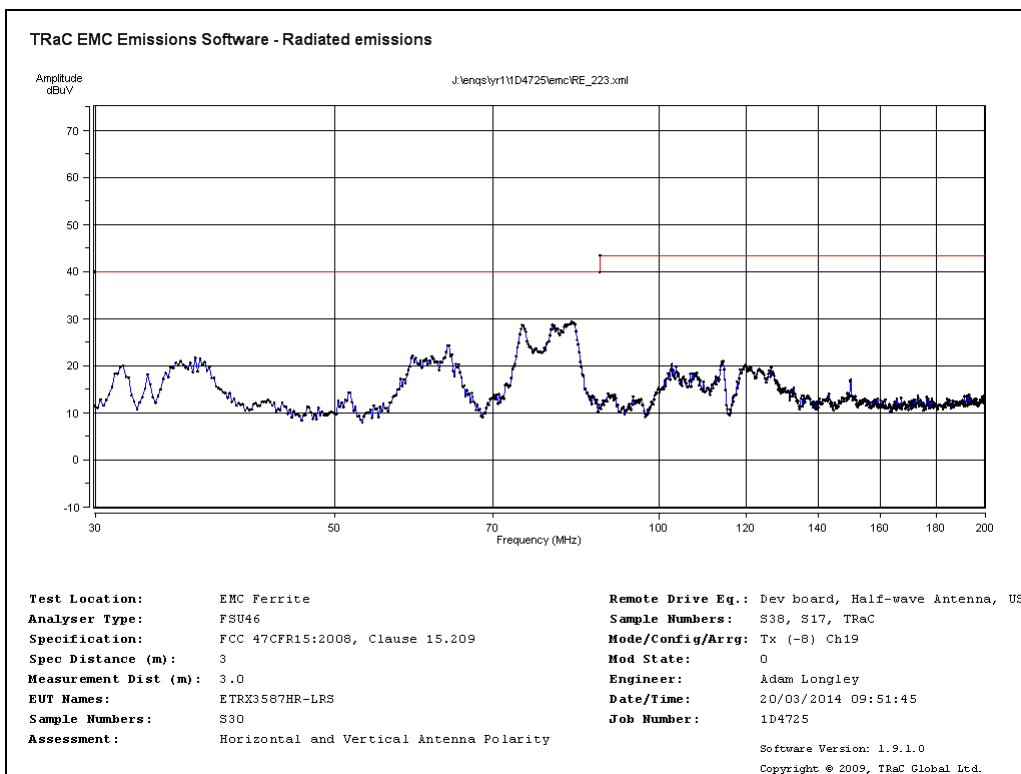

Radiated Transmitter Emissions Channel 19 2445MHz (15.209) Half-wave Antenna  
30MHz -200MHz

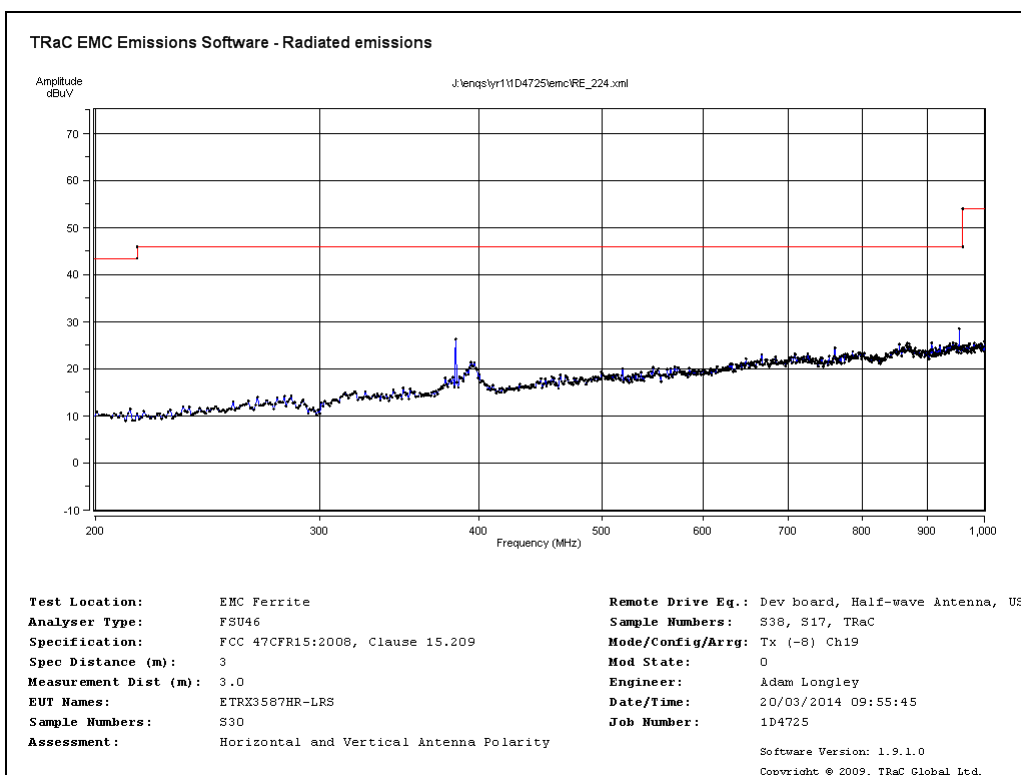

Radiated Transmitter Emissions Channel 19 2445MHz (15.209) Half-wave Antenna  
200MHz -1GHz

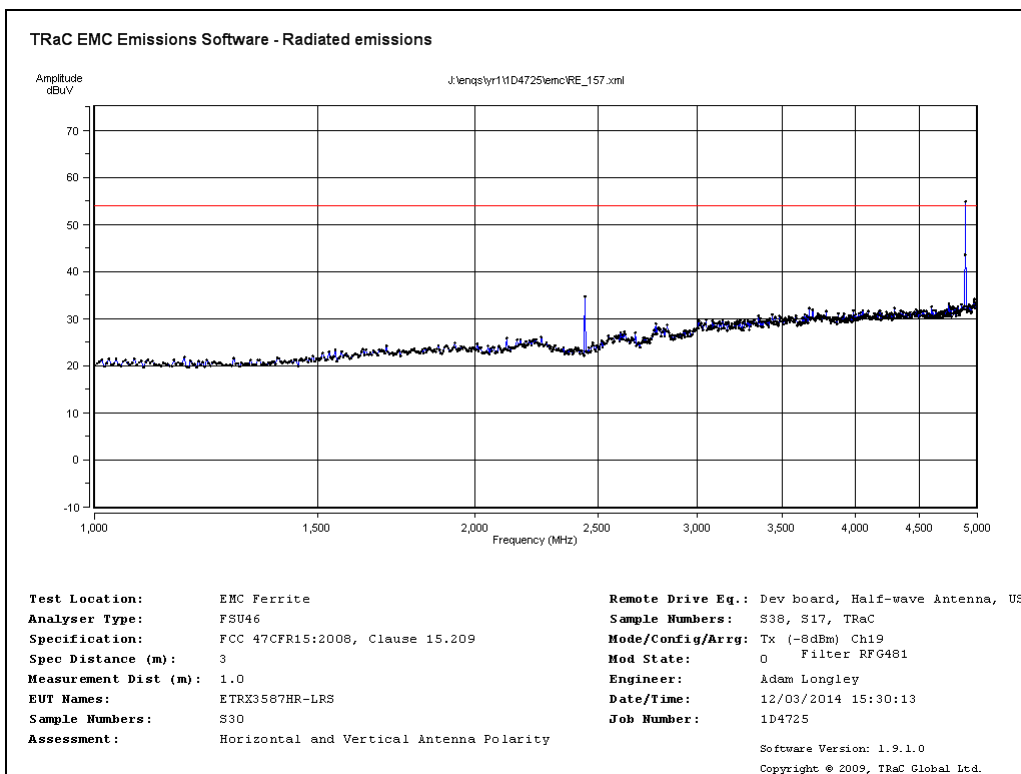

Radiated Transmitter Emissions Channel 19 2445MHz (15.209) Half-wave Antenna  
1GHz -5GHz

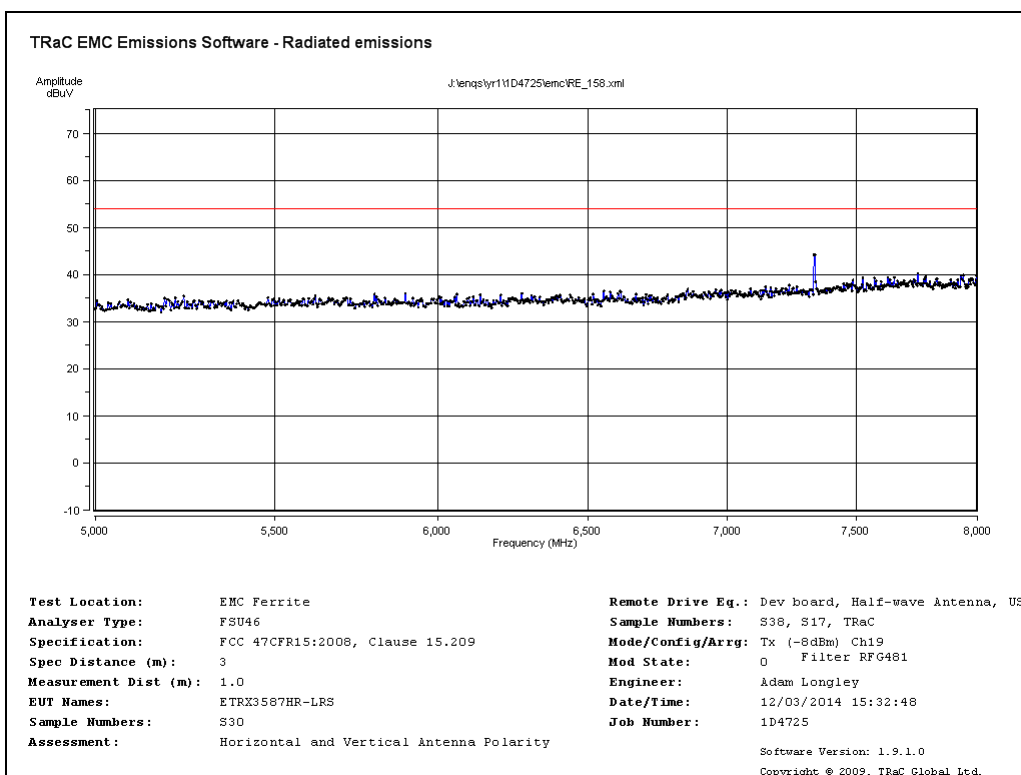

Radiated Transmitter Emissions Channel 19 2445MHz (15.209) Half-wave Antenna  
5GHz -8GHz

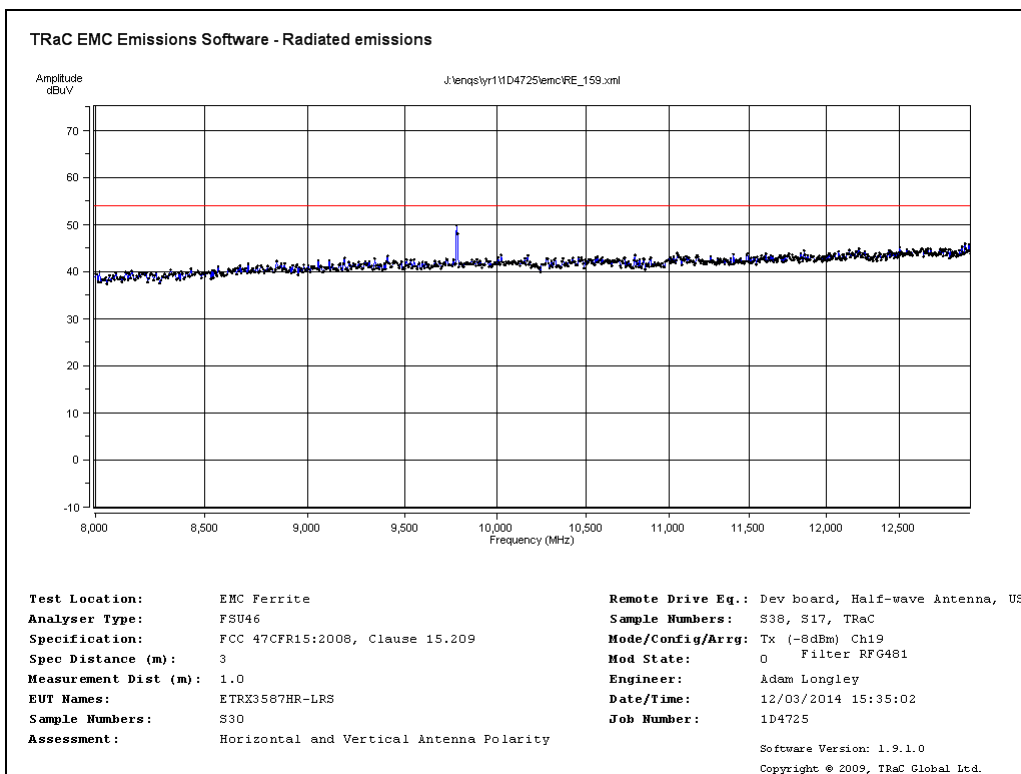

Radiated Transmitter Emissions Channel 19 2445MHz (15.209) Half-wave Antenna  
8GHz -13GHz

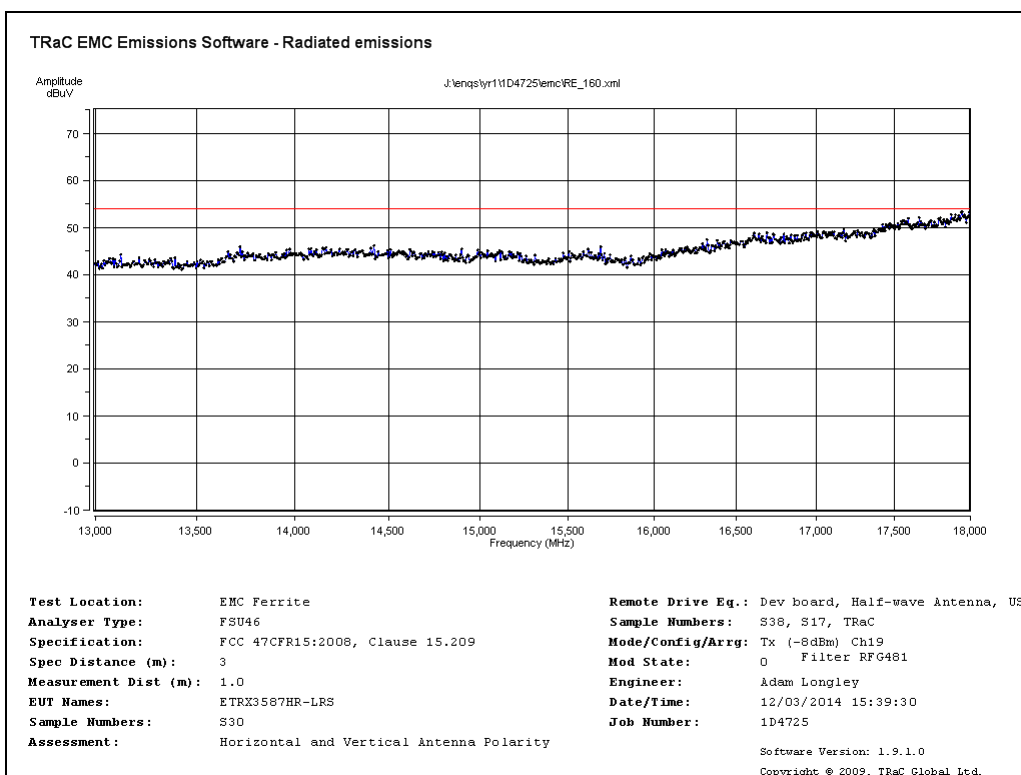

Radiated Transmitter Emissions Channel 19 2445MHz (15.209) Half-wave Antenna  
13GHz -18GHz

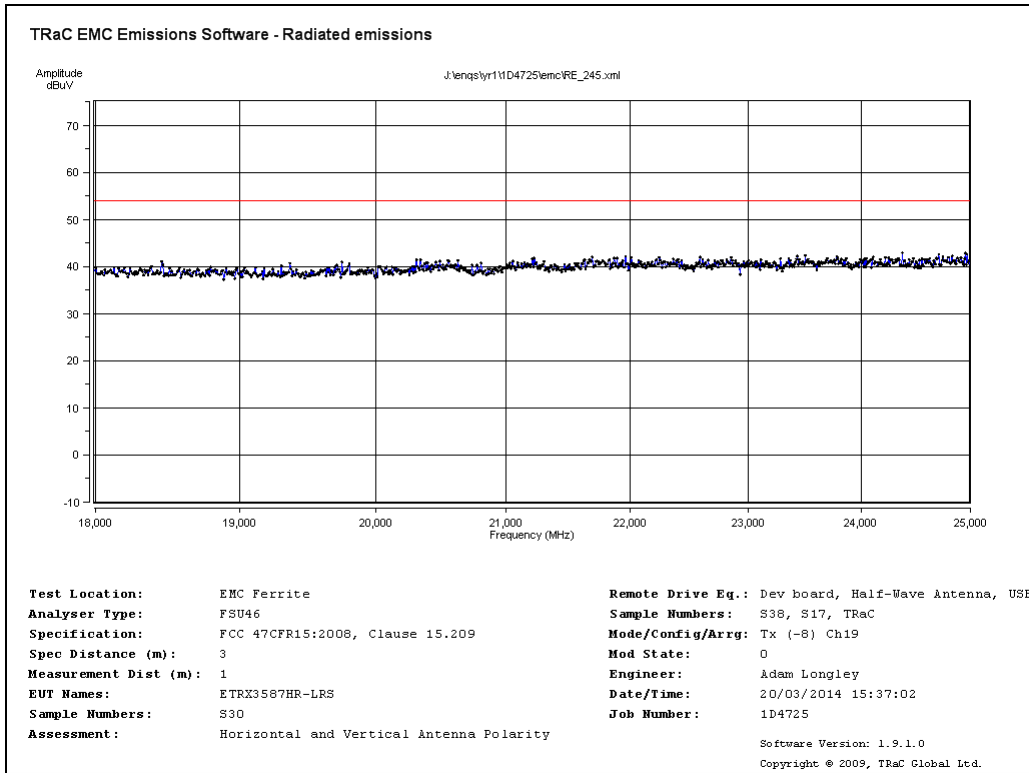

Radiated Transmitter Emissions Channel 19 2445MHz (15.209) Half-wave Antenna  
18GHz -25GHz

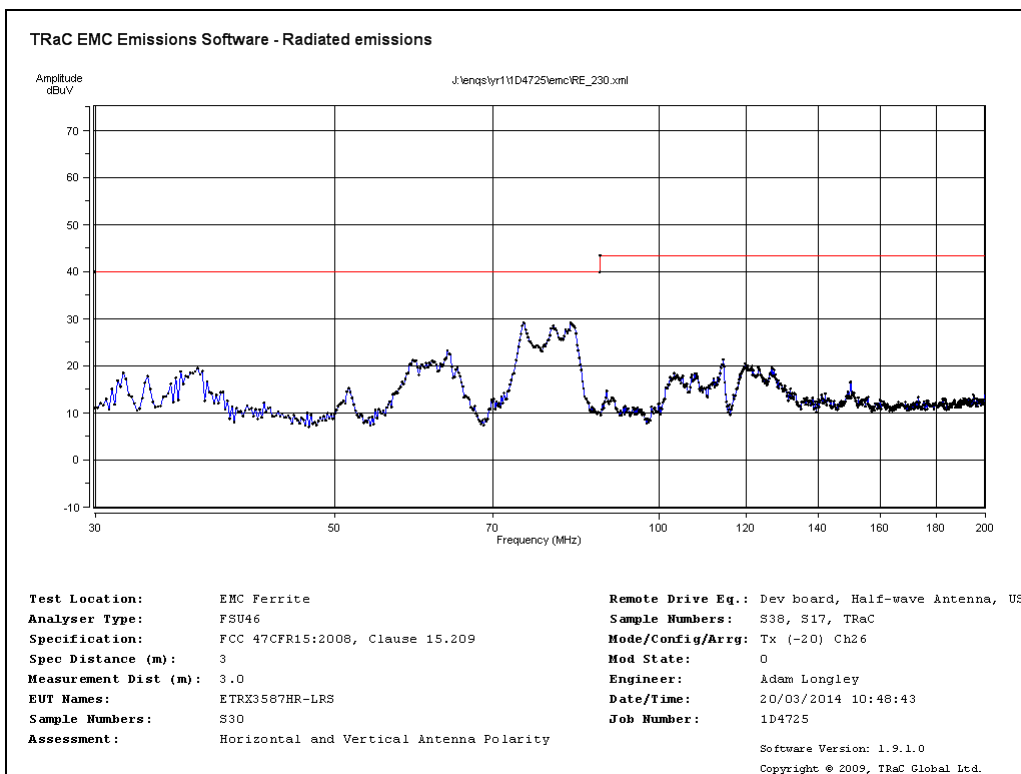

Radiated Transmitter Emissions Channel 26 2480MHz (15.209) Half-wave Antenna  
30MHz-200MHz

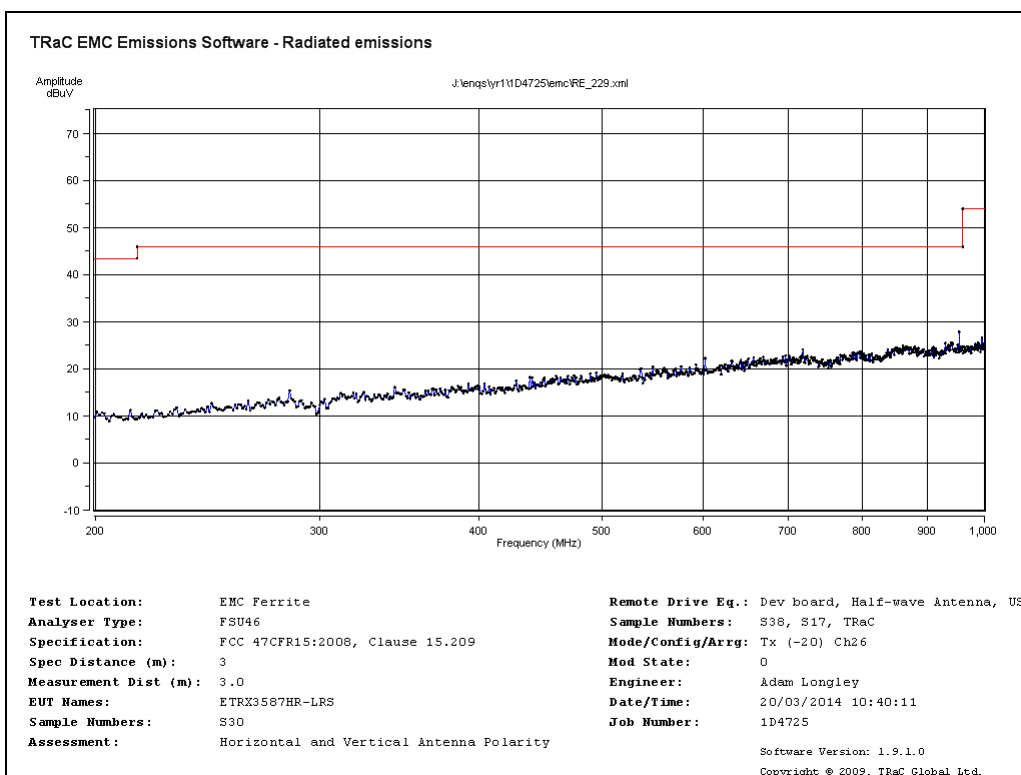

Radiated Transmitter Emissions Channel 26 2480MHz (15.209) Half-wave Antenna  
200MHz-1GHz

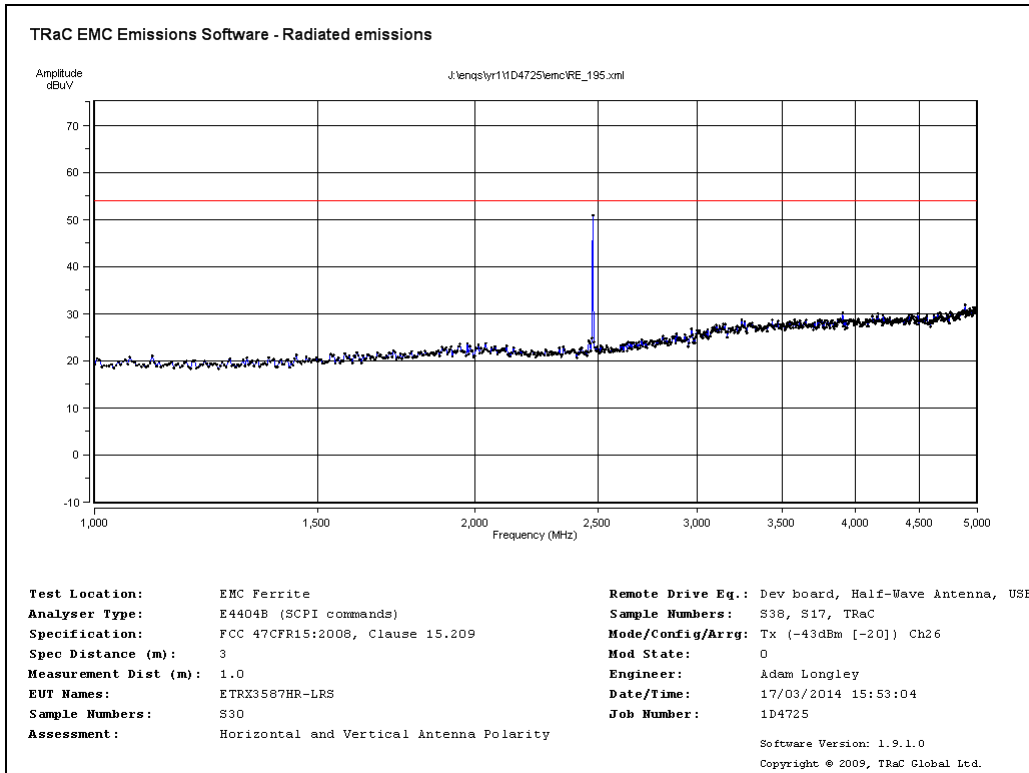

Radiated Transmitter Emissions Channel 26 2480MHz (15.209) Half-wave Antenna  
1GHz-5GHz

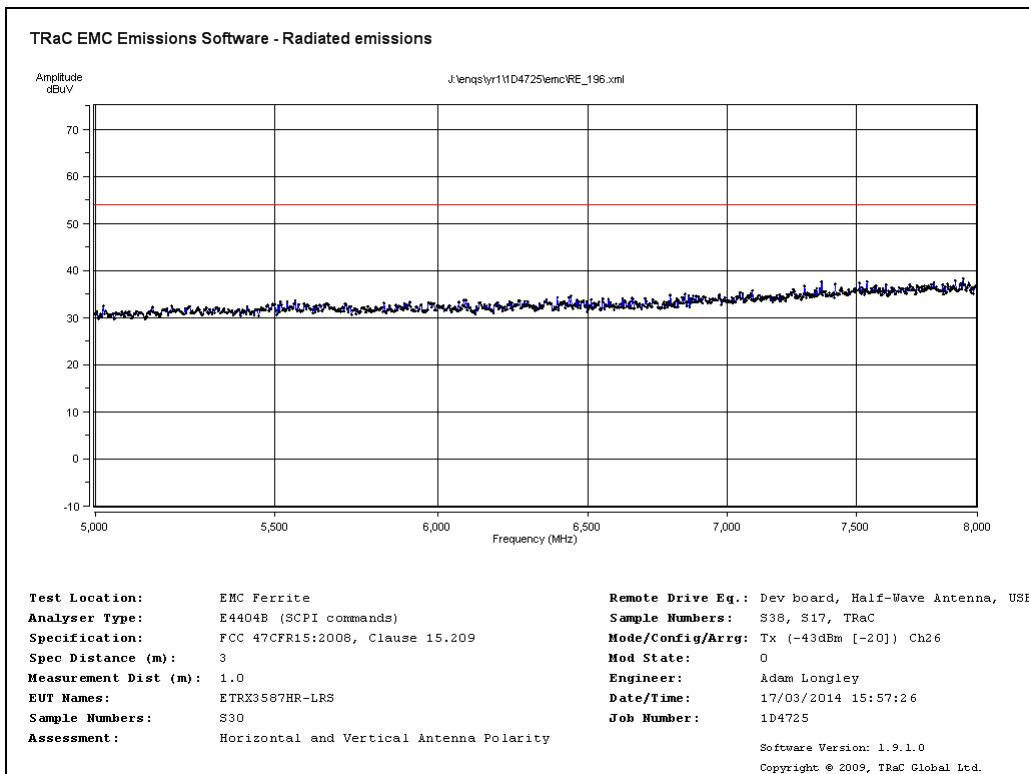

Radiated Transmitter Emissions Channel 26 2480MHz (15.209) Half-wave Antenna  
5GHz-8GHz

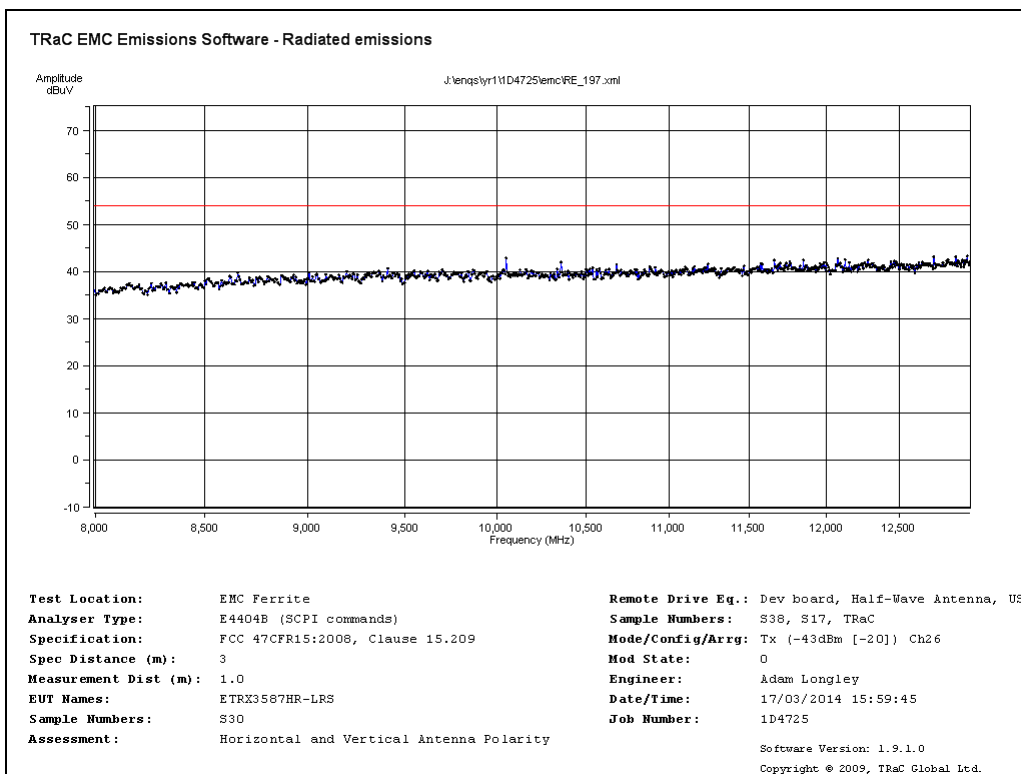

Radiated Transmitter Emissions Channel 26 2480MHz (15.209) Half-wave Antenna  
8GHz-13GHz

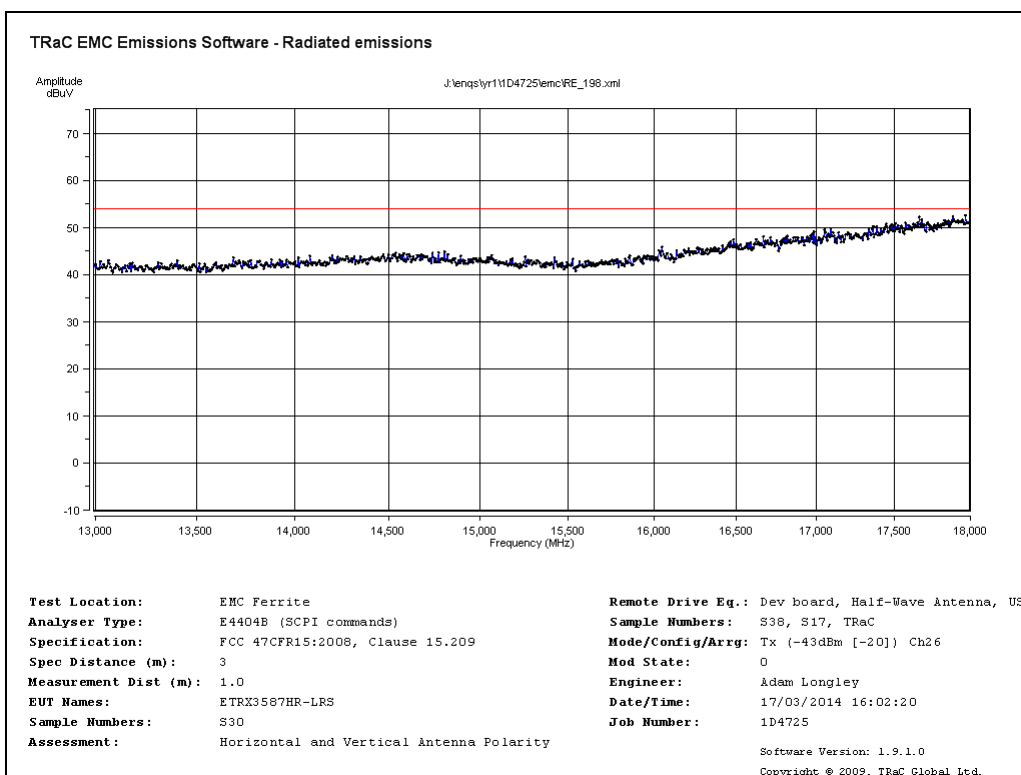

Radiated Transmitter Emissions Channel 26 2480MHz (15.209) Half-wave Antenna  
13GHz-18GHz



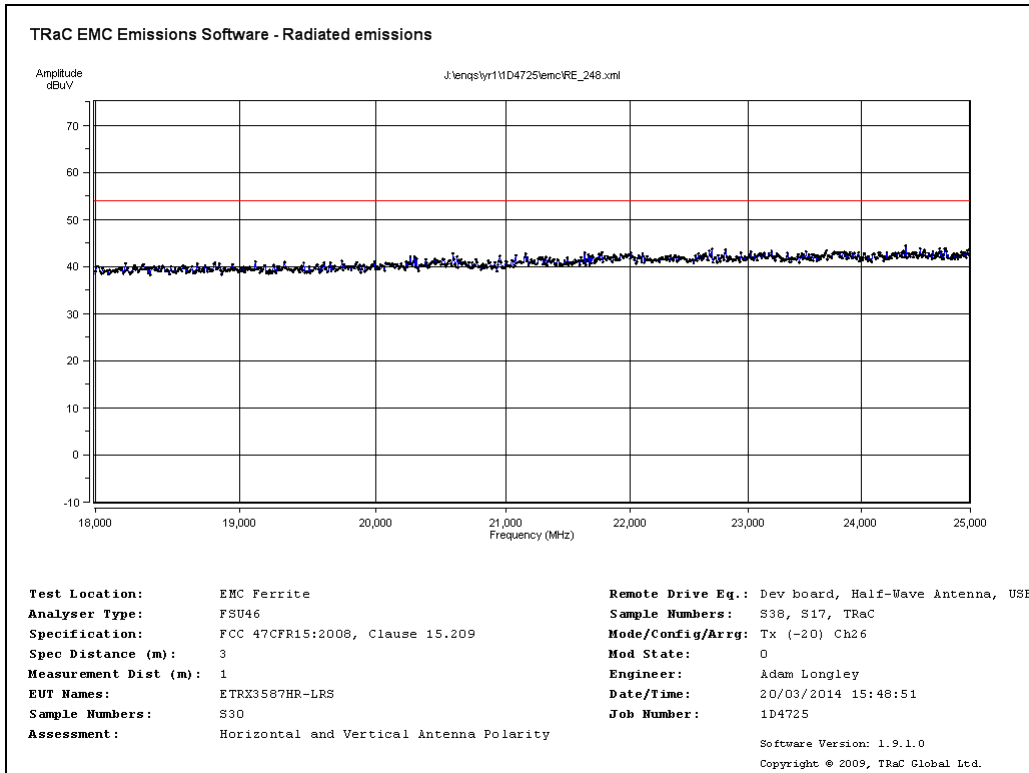

Radiated Transmitter Emissions Channel 26 2480MHz (15.209) Half-wave Antenna  
18GHz-25GHz

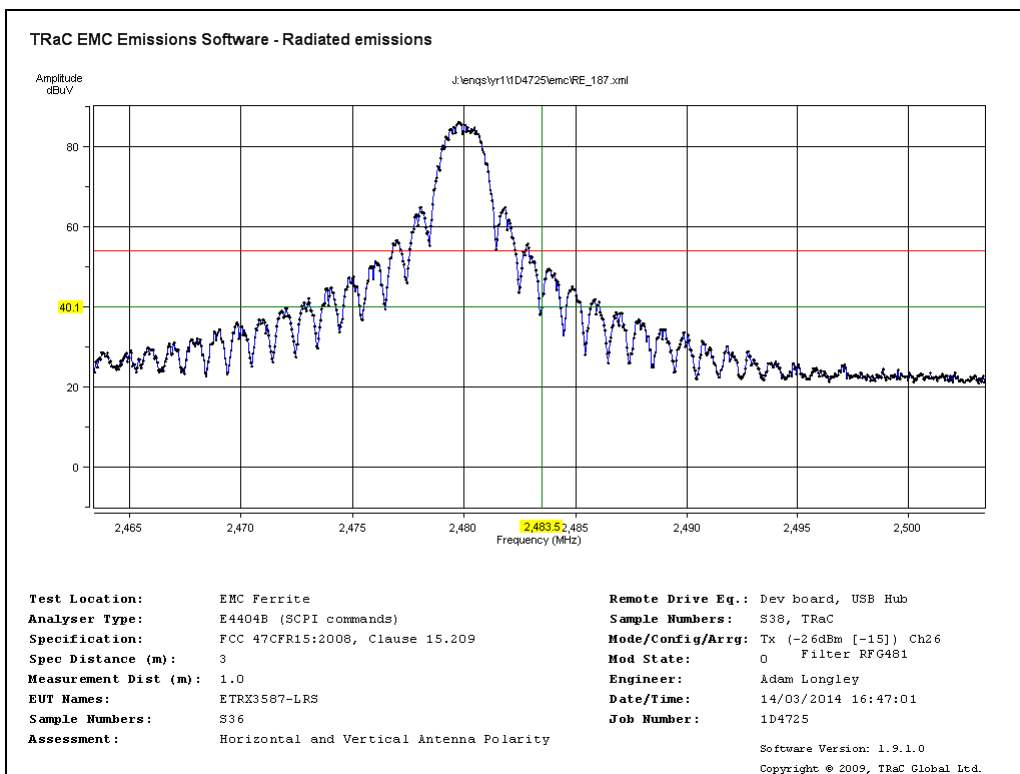

Radiated Transmitter Emissions Channel 26 2480MHz (15.209) Band Edge Compliance  
Band-Edge plot Chip Antenna

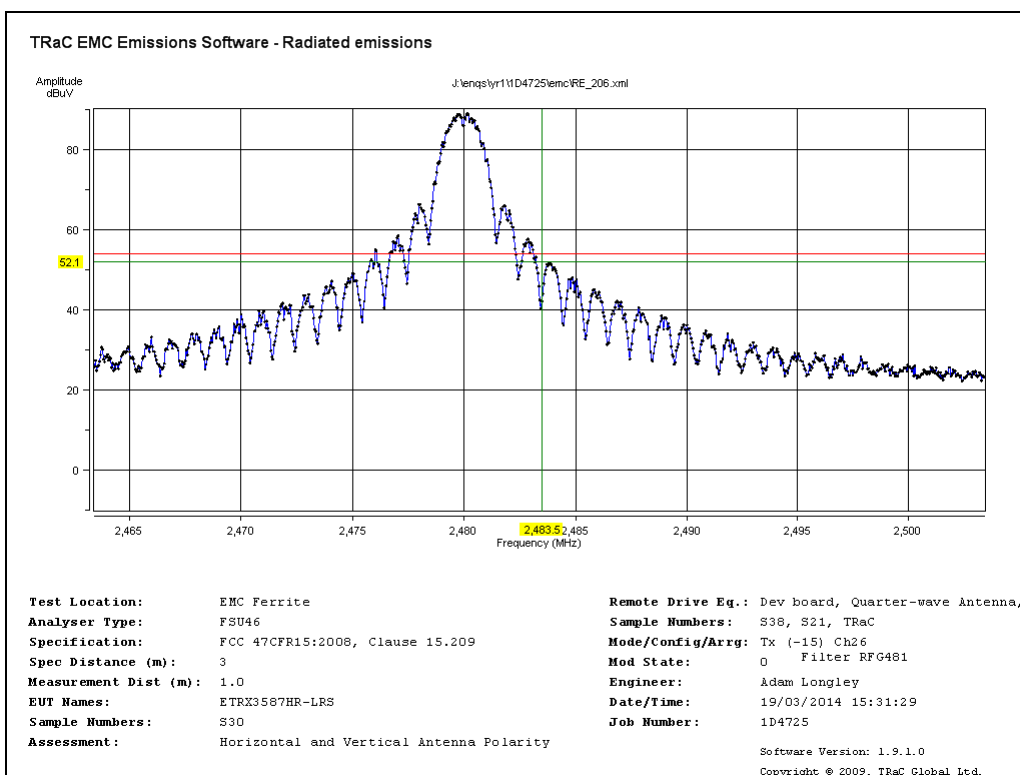

Radiated Transmitter Emissions Channel 26 2480MHz (15.209) Band Edge Compliance  
Band-Edge plot Quarter-wave Antenna

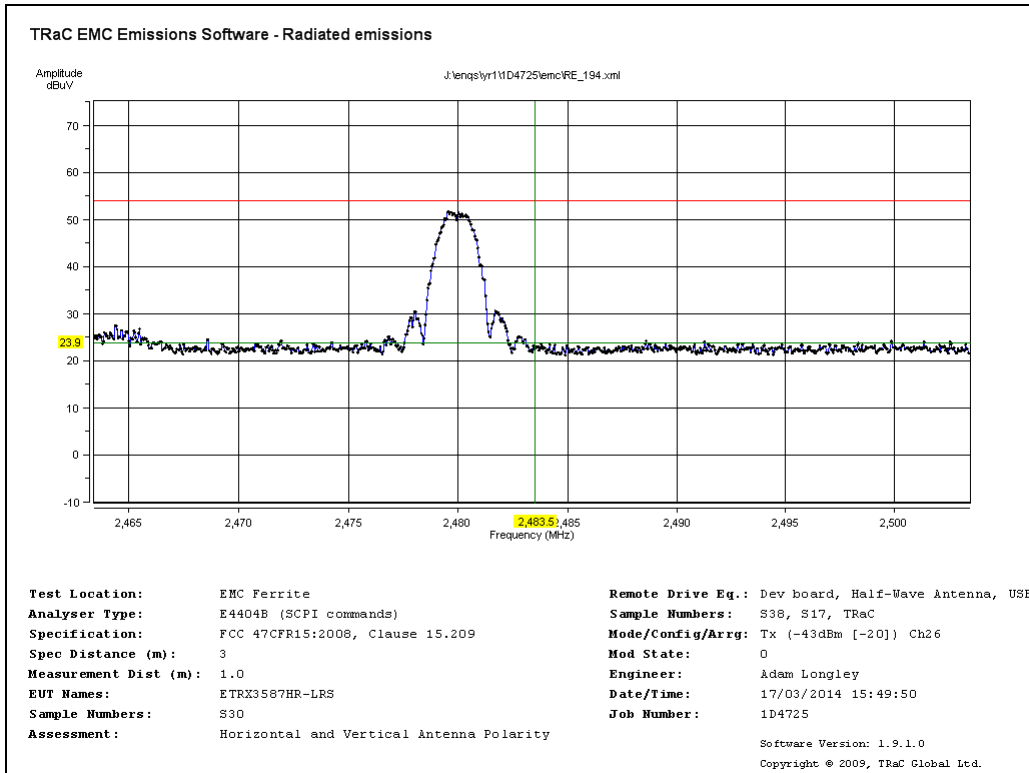

Radiated Transmitter Emissions Channel 26 2480MHz (15.209) Band Edge Compliance  
Band-Edge plot (Half-wave Antenna)

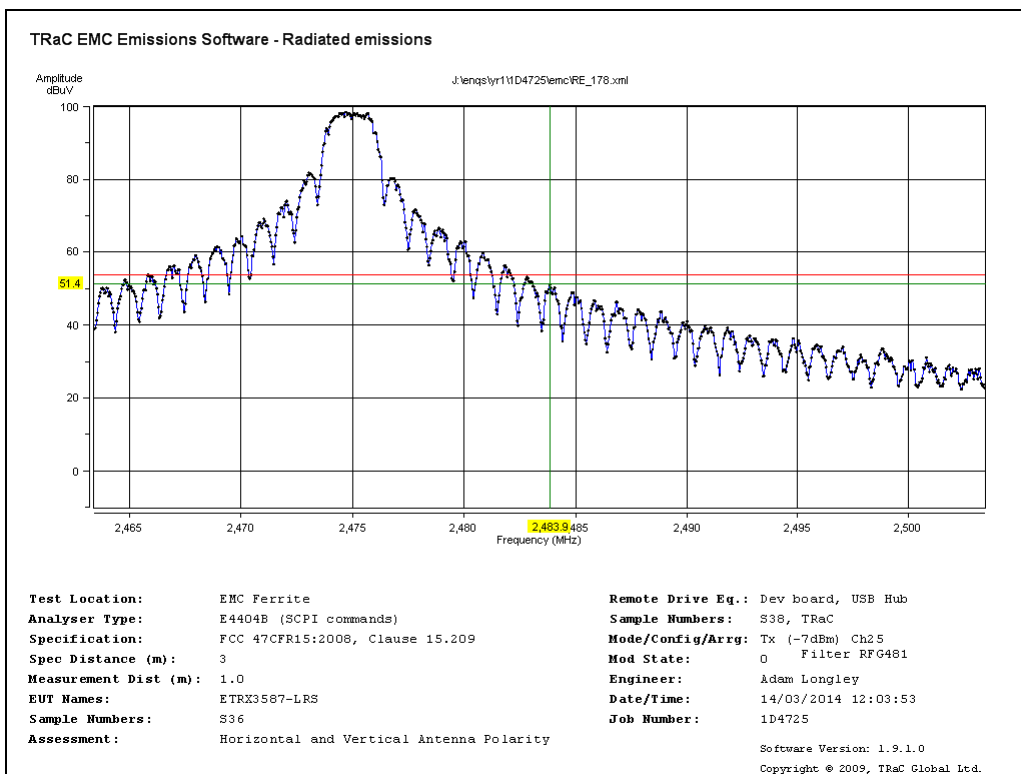

Radiated Transmitter Emissions Channel 25 2475MHz (15.209) Band Edge Compliance Band-Edge plot) Chip Antenna

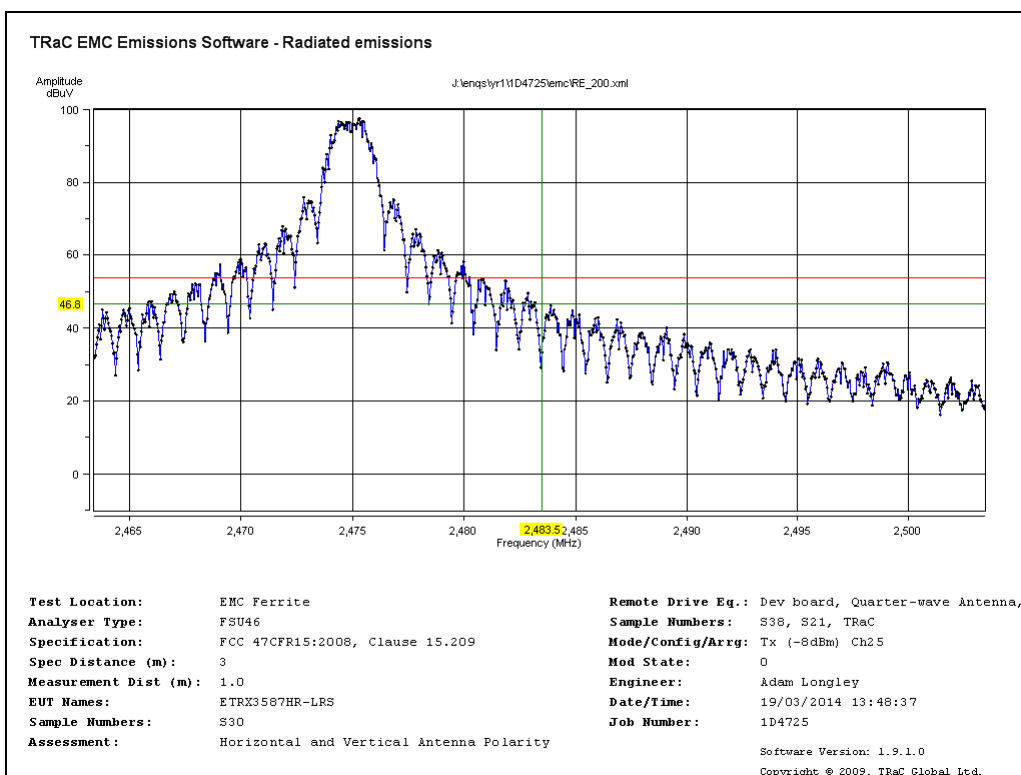

Radiated Transmitter Emissions Channel 25 2475MHz (15.209) Band Edge Compliance Band-Edge plot Quarter-wave Antenna

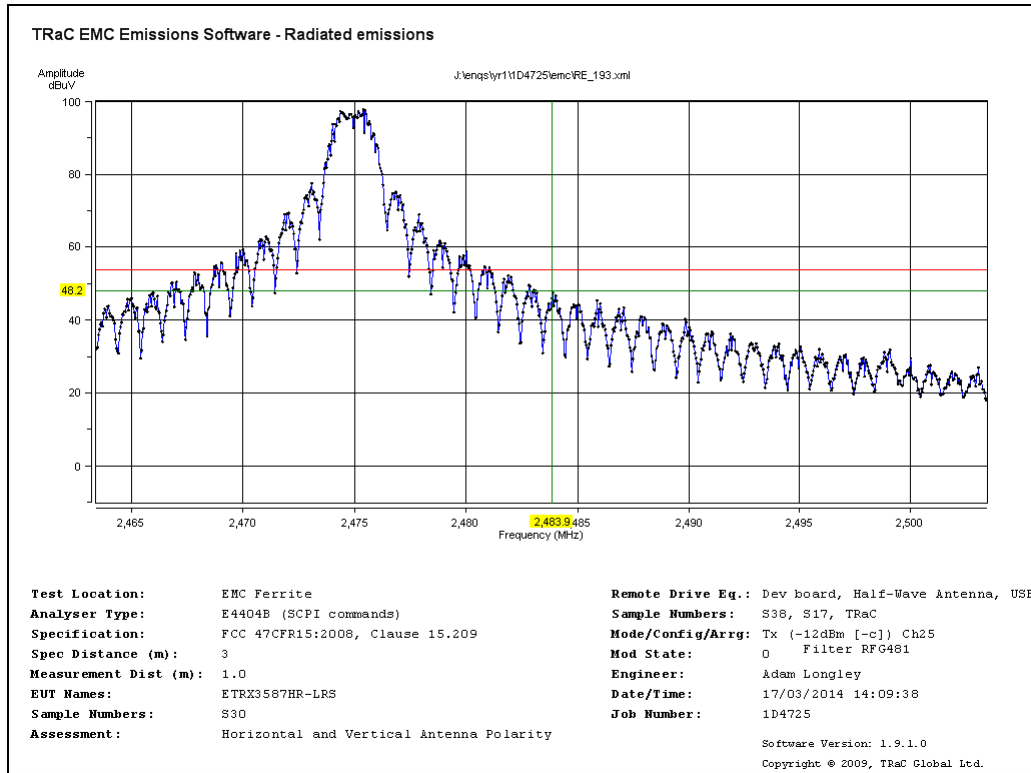

Radiated Transmitter Emissions Channel 25 2475MHz (15.209) Band Edge Compliance  
Band-Edge plot Half-wave Antenna

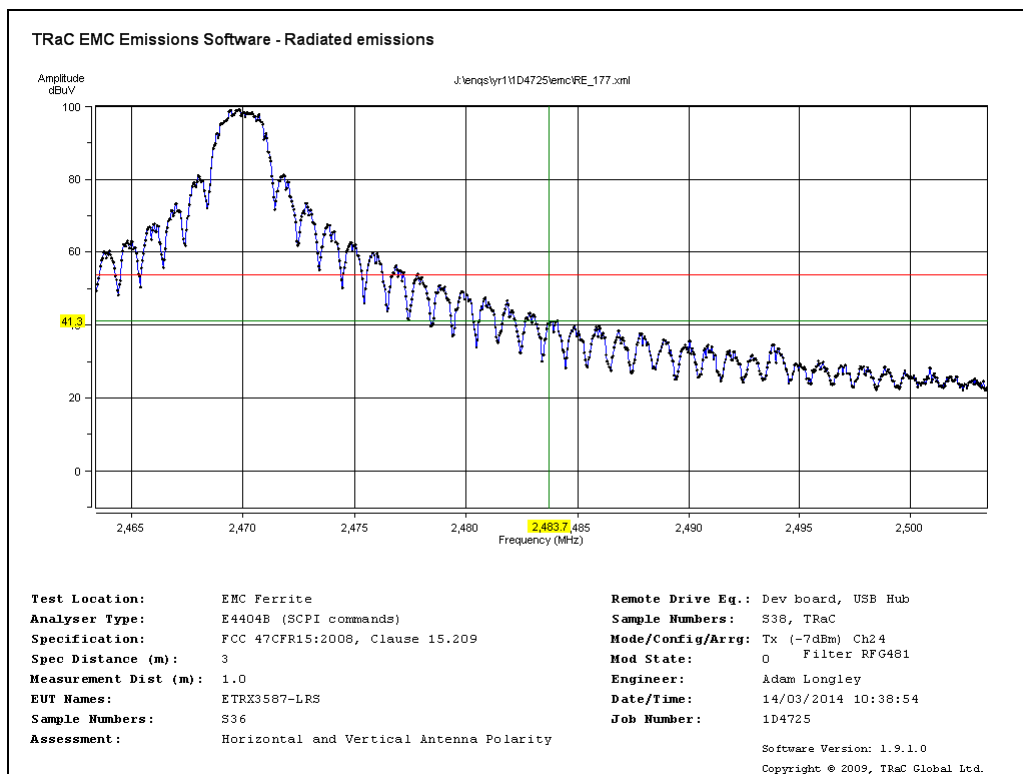

Radiated Transmitter Emissions Channel 24 2470MHz (15.209) Band Edge Compliance Band-Edge plot Chip Antenna

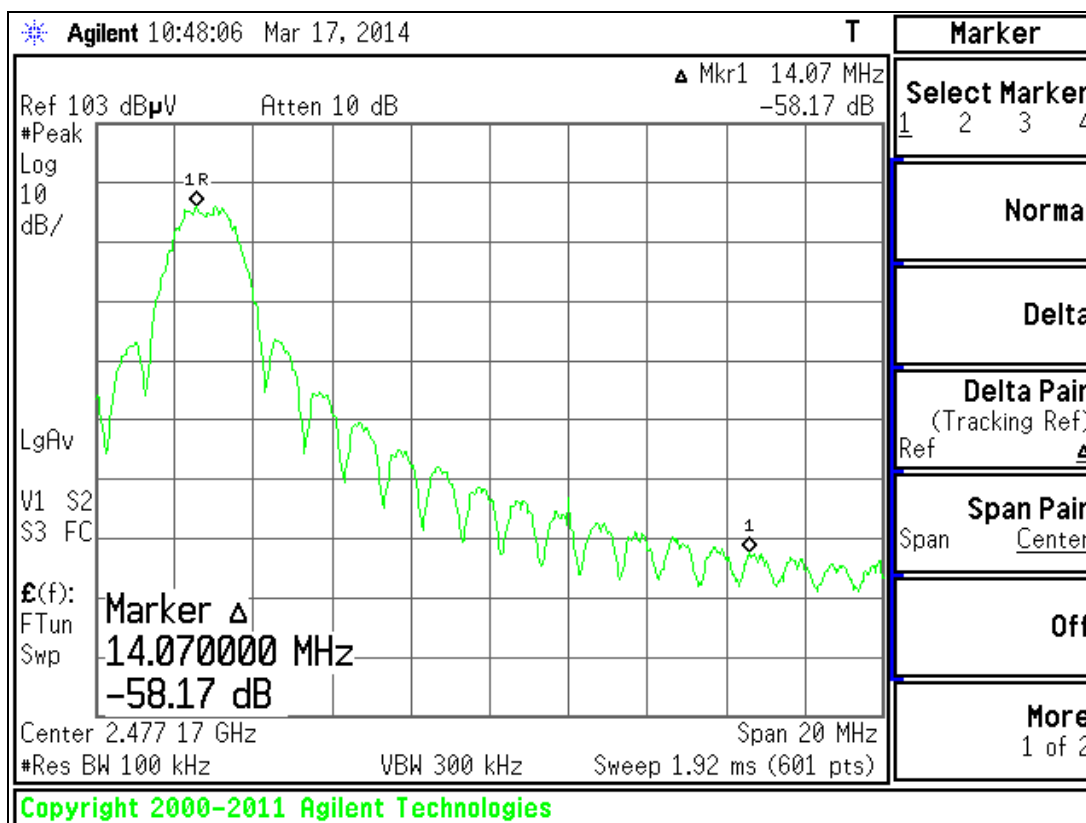

Radiated Transmitter Emissions Channel 24 2470MHz (15.209) Band Edge Compliance Marker-Delta (power setting -8) plot Half-wave Antenna

**Appendix C:****Additional Test and Sample Details**

This appendix contains details of:

1. The samples submitted for testing.
2. Details of EUT operating mode(s)
3. Details of EUT configuration(s) (see below).
4. EUT arrangement (see below).

Throughout testing, the following numbering system is used to identify the sample and it's modification state:

**Sample No:** Sxx Mod w

where:

xx	= sample number	eg. S01
w	= modification number	eg. Mod 2

The following terminology is used throughout the test report:

**Support Equipment (SE)** is any additional equipment required to exercise the EUT in the applicable operating mode. Where relevant SE is divided into two categories:

SE in test environment: The SE is positioned in the test environment and is not isolated from the EUT (e.g. on the table top during REFE testing).

SE isolated from the EUT: The SE is isolated via filtering from the EUT. (e.g. equipment placed externally to the ALSR during REFE testing).

**EUT configuration** refers to the internal set-up of the EUT. It may include for example:

- Positioning of cards in a chassis.
- Setting of any internal switches.
- Circuit board jumper settings.
- Alternative internal power supplies.

Where no change in EUT configuration is **possible**, the configuration is described as "single possible configuration".

EUT arrangement refers to the termination of EUT ports / connection of support equipment, and where relevant, the relative positioning of samples (EUT and SE) in the test environment.

For further details of the test procedures and general test set ups used during testing please refer to the related document "EMC Test Methods - An Overview", which can be supplied by TRaC Global Ltd upon request.

**C1) Test samples**

The following samples of the apparatus were submitted by the client for testing :

Sample No.	Description	Identification
S36	ETRX3587-LRS Module with Chip Antenna	DoM : 140226
S30	ETRX3587HR-LRS Module with Antenna Port	DoM : 140226
S17	Half-wave Antenna (with SMA connector)	None
S21	Quarter-wave Antenna (with SMA connector)	None

The following samples of the apparatus were submitted by the client as support equipment (SE)

Sample No.	Description	Identification
S38	Telegesis Host Board (with unnecessary module mounting pins removed).	R303
S15	Mini-USB cable	None

The following equipment was supplied by TRaC and used as support equipment (SE)

Sample No.	Description	Identification
-	Belkin Powered USB Hub	F5U234 Rev 3
-	Dell Laptop	-



**C2) EUT Operating Mode During Testing.**

During testing, the EUT was exercised as described in the following tables :

Test	Description of Operating Mode: Transmit
All tests, except as described below	The Following EUT settings were entered via Telegesis Terminal: Settxpowmode 0 1 <b>Chip antenna:</b> Settxpower -7 (level -15 was used on channel 26) <b>Quarter-wave antenna:</b> Settxpower -8 (level -15 was used on channel 26) <b>Half-wave antenna:</b> Settxpower -8 (level c was used on channel 25) (level -20 was used on channel 26) Setchannel (11 / 19 / 24 / 25 / 26 were used) TxStream

Test	Description of Operating Mode: Transmit
6dB Bandwidth Power Spectral Density Conducted Carrier Power Conducted Spurious Emissions	The Following EUT settings were entered via Telegesis Terminal: Settxpowmode 0 1 Settxpower -7 (level -15 was used on channel 26) Setchannel (11 / 19 / 24 / 25 / 26 were used) TxStream

Test	Description of Operating Mode: Receive/Standby mode
Receiver Spurious Emissions	EUT powered and not transmitting

**C3) EUT Configuration Information.**

The EUT was submitted for testing in one single possible configuration.

Three antennas were supplied and were used for radiated testing.

**C4) List of EUT Ports**

The tables below describe the termination of EUT ports:

Sample : S38  
 Tests : Radiated Electric Field Emissions Restricted band 15.209 (15.205) and 15.109 digital circuitry

Port	Description of Cable Attached	Cable length	Equipment Connected
Module	None	-	Module under test (S30 / S36)
Mini USB	Mini USB lead	1m	Powered USB Hub

Sample : S38  
 Tests : RF Antenna Port Conducted Spurious Emissions, 6dB Bandwidth, Power Spectral Density and Conducted Fundamental Carrier Power

Port	Description of Cable Attached	Cable length	Equipment Connected
Module	None	-	Module under test (S30 / S36)
Mini USB	Mini USB lead	1m	Dell Laptop

Sample : S30  
 Tests : Radiated Electric Field Emissions Restricted band 15.209 (15.205) and 15.109 digital circuitry

Port	Description of Cable Attached	Cable length	Equipment Connected
Module	None	-	S38
Antenna Port	Coax uFL to SMA cable	10cm	Antenna (S17 / S21)

Sample : S30  
 Tests : RF Antenna Port Conducted Spurious Emissions, 6dB Bandwidth, Power Spectral Density and Conducted Fundamental Carrier Power

Port	Description of Cable Attached	Cable length	Equipment Connected
Module	None	-	S38
Antenna Port	Coax uFL to SMA cable	10cm	Antenna (S17 / S21)

S36 was fitted with a Chip antenna and had no other connections when fitted into S38.

**C5 Details of Equipment Used**

For Radiated Measurements:

TRAC REF/RFG No.	Type	Description	Manufacturer	Date Calibrated.
REF886	ATS	Ferrite Lined Chamber	TRaC	10/05/13
095		Biconical Antenna	EMCO	09/05/13
191		Log Periodic Antenna	EMCO	09/05/13
RFG682	HL050	GHz Log Periodic Antenna	Rhode & Schwarz	16/07/13
RFG629		Horn Antenna	Q-Par	19/09/13
REF927	310	Pre-Amp (9kHz – 1GHz)	Sonoma	15/09/11
REF913	8449B	Pre-Amp (1 – 26.5GHz)	Agilent	31/01/13
RFG452		SMA RF coaxial cable		03/07/13
REF881		N-Type RF coaxial cable		01/07/13
REF882		N-Type RF coaxial cable		01/07/13
REF884		N-Type RF coaxial cable		01/07/13
REF885		N-Type RF coaxial cable		01/07/13
RFG832		K-Type RF coaxial cable	Teleydyne	04/07/13
RFG919		K-Type RF coaxial cable	Teleydyne	04/07/13
REF837	E4440A	Spectrum Analyser	Agilent	10/05/13

For Conducted Measurements

TRAC REF/RFG No.	Type	Description	Manufacturer	Date Calibrated.
REF909	FSU	Spectrum Analyser	Rhode & Schwarz	30/02/13
REF837	E4440A	Spectrum Analyser	Agilent	10/05/13

**Appendix D:**

**Additional Information**

The following antenna data sheets were provided.



# Rufa 2.4 GHz SMD Antenna

Part No. A5839 / A5887

Product Specification

## 1 Features

- Designed for 2.4 GHz applications: Bluetooth®, Wi-Fi® (802.11b/g), ZigBee®, etc.
- Easy to integrate
- Low profile design for use with no ground beneath the antenna
- High efficiency
- Light weight
- Intended for SMD mounting
- Supplied in tape on reel

## 2 Description

Rufa is intended for use with all 2.4 GHz applications. The antenna uses a ground plane in order to radiate efficiently, but this ground plane must not extend underneath the antenna itself.

The antenna is available in two versions with the feed locations on the right or left hand side of the antenna.

## 3 Applications

- Mobile phones
- PDAs
- PNDs
- Headsets
- PMPs / MP3s
- Laptops
- PC-Cards
- Sensors



Antennas for Wireless M2M Applications

1

Product Specification AE020157-O

Rufa 2.4 GHz SMD Antenna  
Part No. A5839 / A5887

#### 4 Part numbers

Rufa Left: A5839



Rufa Right: A5887



#### 5 General data

Product name	Rufa 2.4 GHz
Part Number	A5839 (Left)
	A5887 (Right)
Frequency	2.4 – 2.5 GHz
Polarization	Linear
Operating temperature	-40 °C to +85 °C
Impedance with matching	50 Ω
Weight	0.1 g
Antenna type	SMD
Dimensions	12.8 x 3.9 x 1.1 [mm]

#### 6 Electrical characteristics

	Typical performance	Conditions
Peak gain	2.1 dBi	All data measured on Antenova's reference boards, part numbers A5839-U1 and A5887-U1  Data given for the 2.4 – 2.5 GHz frequency range
Average gain	-1.2 dBi	
Average efficiency	75%	
Maximum Return Loss	-11 dB	
Maximum VSWR	1.8:1	

Antennas for Wireless M2M Applications

2  
Product Specification AE020157-O

Rufa 2.4 GHz SMD Antenna  
Part No. A5839 / A5887

## 7 Electrical performance

### 7-1 Return Loss

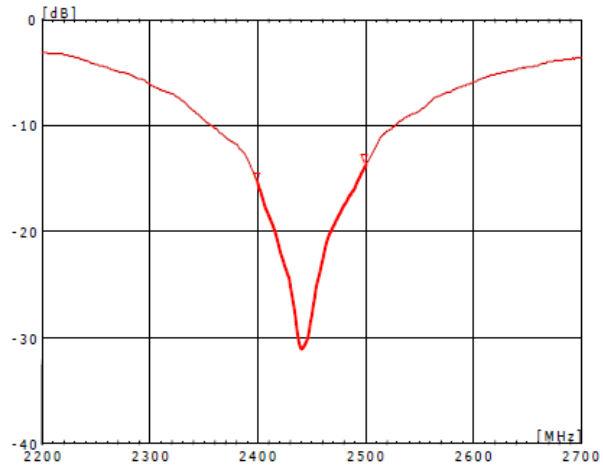

### 7-2 VSWR

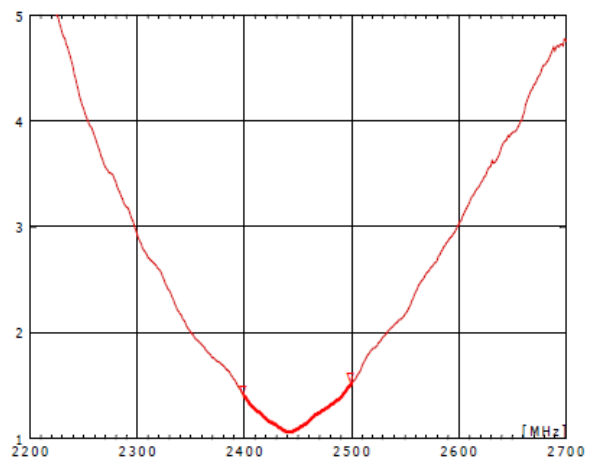

Antennas for Wireless M2M Applications



Rufa 2.4 GHz SMD Antenna  
Part No. A5839 / A5887

### 7-3 Antenna patterns

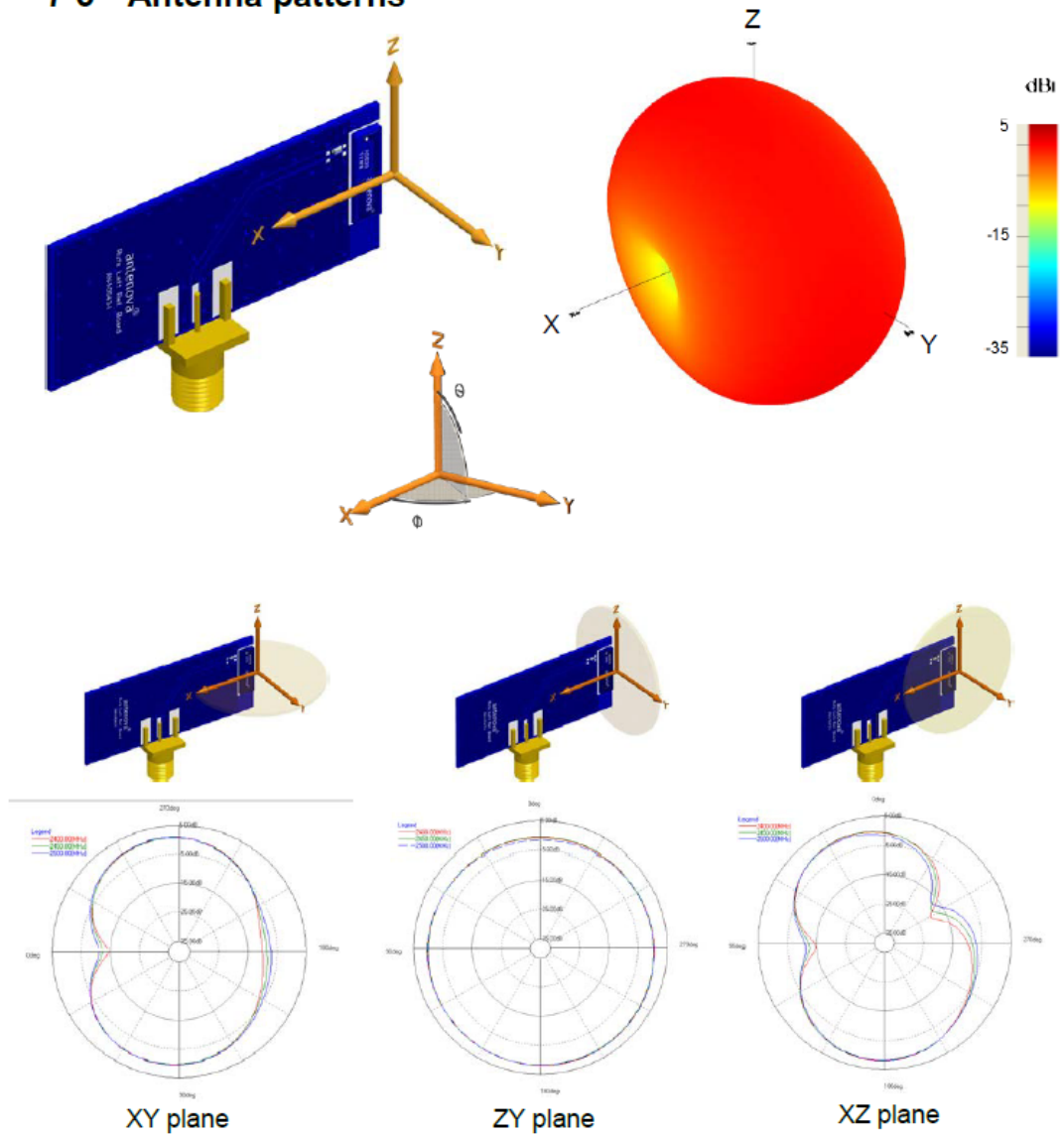

Patterns show combined polarisations  
measured on reference board A5839-U1

Antennas for Wireless M2M Applications

Rufa 2.4 GHz SMD Antenna  
Part No. A5839 / A5887

### 8 Antenna dimensions

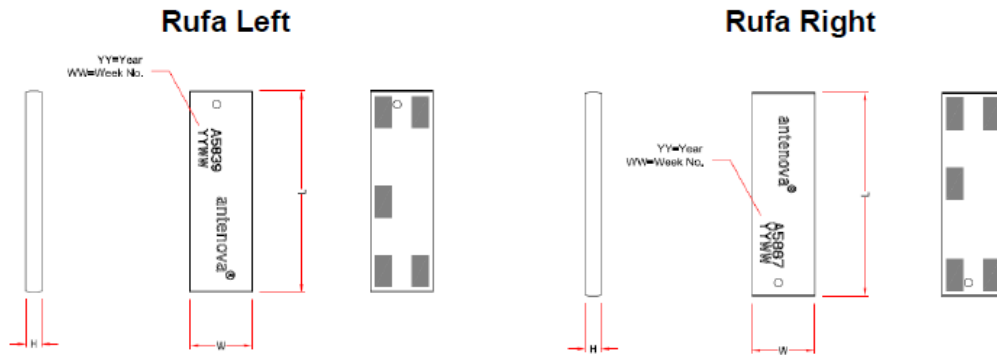

L	W	H
Length	Width	Height
12.8 ± 0.2	3.9 ± 0.2	1.1 ± 0.2

Dimensions in mm

### 9 Antenna footprint

Rufa Left (Part No: A5839)

Rufa Right (Part No: A5887)

\* CAD files of the antenna footprint are available from Antenova M2M on request.

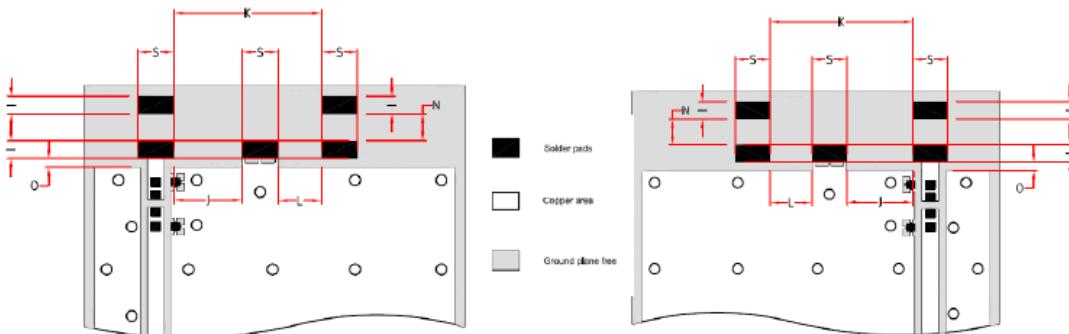

Please contact [sales@antenova-m2m.com](mailto:sales@antenova-m2m.com) for further details.

I	S	K	J	N	L	O
1.0 ± 0.1	2.0 ± 0.1	8.1 ± 0.1	3.7 ± 0.1	1.3 ± 0.1	2.4 ± 0.1	0.5 ± 0.1

Dimensions in mm

Antennas for Wireless M2M Applications

Rufa 2.4 GHz SMD Antenna  
Part No. A5839 / A5887

## 10 Electrical interface

### 10-1 Transmission lines

- All transmission lines should be designed to have a characteristic impedance of  $50 \Omega$
- The length of the transmission lines should be kept to a minimum
- Any other parts of the RF system like transceivers, power amplifiers, etc, should also be designed to have an impedance of  $50 \Omega$

Once the material for the PCB has been chosen (PCB thickness and dielectric constant), a coplanar transmission line can easily be designed using any of the commercial software packages for transmission line design. For the chosen PCB thickness, copper thickness and substrate dielectric constant, the program will calculate the appropriate transmission line width and gaps on either side of the track so the characteristic impedance of the coplanar transmission line is  $50 \Omega$ .

### 10-2 Matching circuit

The antenna requires a matching circuit that must be optimized for each customer's product. The matching circuit will require up to three components and the following pad layout should be designed into the device so the correct circuit can be installed:

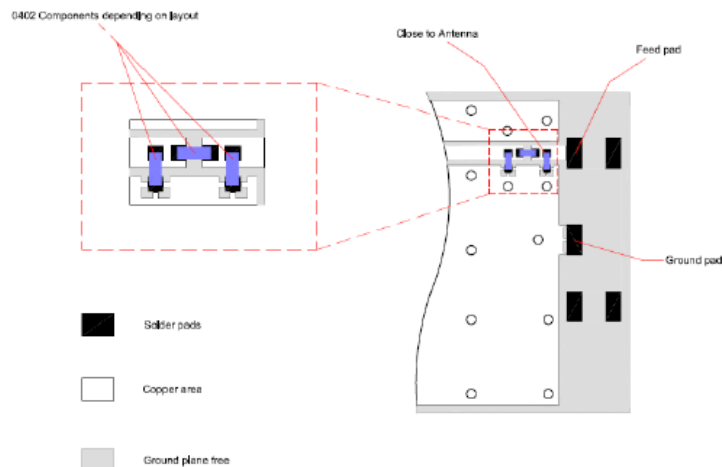

The antenna feed pad and the antenna ground pad are indicated in the drawing above. Additional pads are for mechanical attachment only and should not be grounded.

Antennas for Wireless M2M Applications

6

Product Specification AE020157-O

Rufa 2.4 GHz SMD Antenna  
Part No. A5839 / A5887

In addition to the matching circuit, a separate DC blocking capacitor will also be required between the radio and the antenna matching circuit.

**Note: The component values for the matching circuit will vary depending on the size of the PCB and surrounding components.** The impedance of the antenna should be measured before selecting suitable matching components. Antenova M2M offers this service on request. Contact [sales@antenova-m2m.com](mailto:sales@antenova-m2m.com) for further information.

### 10-3 Antenna placement

Antenova M2M strongly recommends placing the antenna near the edge of the board. Maximum antenna performance is achieved by placing the antenna towards one of the corners of the PCB and with the feed point of the antenna as close to same corner of the PCB as possible.

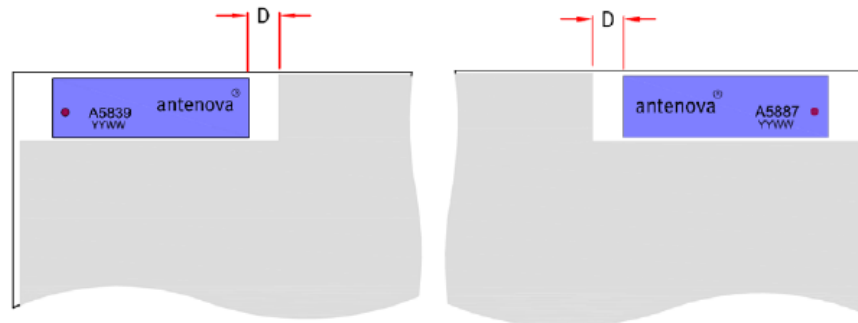

Additional ground and components near the antenna should be at a distance of at least 2 mm. Where possible the antenna should be clear of ground from both sides, although the antenna can work well with a minimum clearance of  $D \geq 2$  mm as shown in the drawing above.

Rufa 2.4 GHz SMD Antenna  
Part No. A5839 / A5887

### 10-4 Reference boards

The reference boards have been designed for evaluation purposes of Rufa 2.4 GHz and they include a SMA female connector

**Rufa Left**

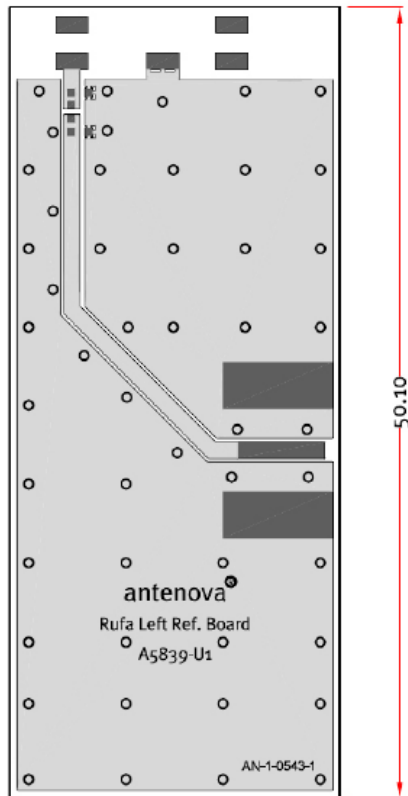

**Rufa Right**

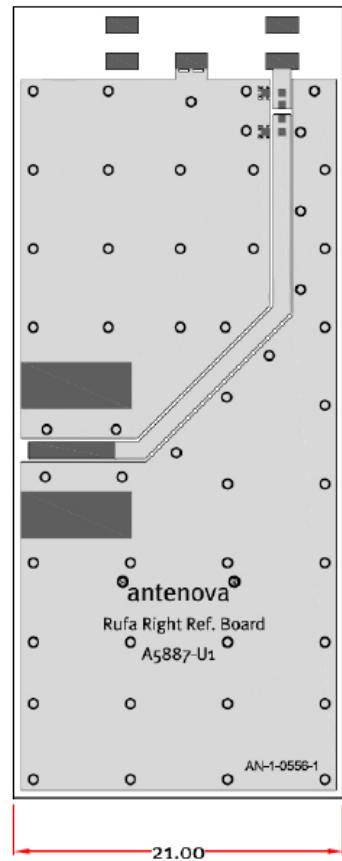

Dimensions in mm

To order a reference board contact [sales@antenna-m2m.com](mailto:sales@antenna-m2m.com).

Antennas for Wireless M2M Applications

Rufa 2.4 GHz SMD Antenna  
Part No. A5839 / A5887

## 11 Soldering

This antenna is suitable for lead free soldering.

The reflow profile should be adjusted to suit the device, oven and solder paste, while observing the following conditions:

- The maximum temperature should not exceed 240 °C
- However for lead free soldering, a maximum temperature of 255 °C for no more than 20 seconds is permitted.
- The antenna should not be exposed to temperatures exceeding 120 °C more than 3 times during the soldering process.

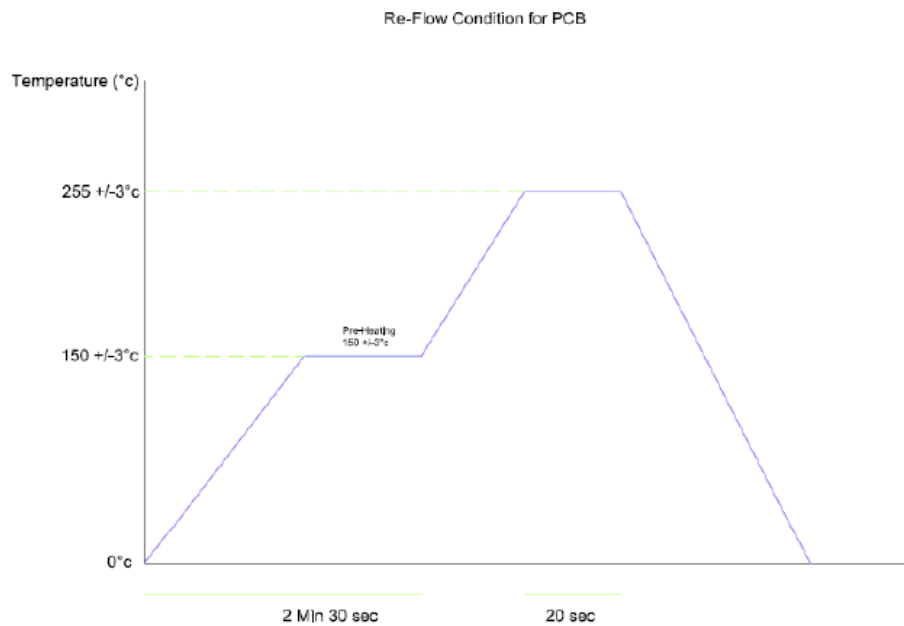

## 12 Hazardous material regulation conformance

The antenna has been tested to conform to RoHS requirements. A certificate of conformance is available from Antenova's website.

Antennas for Wireless M2M Applications

9

Product Specification AE020157-O

Rufa 2.4 GHz SMD Antenna  
Part No. A5839 / A5887

## 13 Packaging

### 13-1 Optimal storage conditions for packaged reels

Temperature	-10°C to 40°C
Humidity	Less than 75% RH
Shelf Life	18 Months
Storage place	Away from corrosive gas and direct sunlight
Packaging	Reels should be stored in unopened sealed manufacturer's plastic packaging.

**Note:** Storage of open reels of antennas is not recommended due to possible oxidization of pads on antennas. If short term storage is necessary, then it is highly recommended that the bag containing the antenna reel is re-sealed and stored in like storage conditions as in above table.

Rufa 2.4 GHz SMD Antenna  
Part No. A5839 / A5887

### 13-2 Tape characteristics

**Rufa Left**  
[Part Number: A5839]

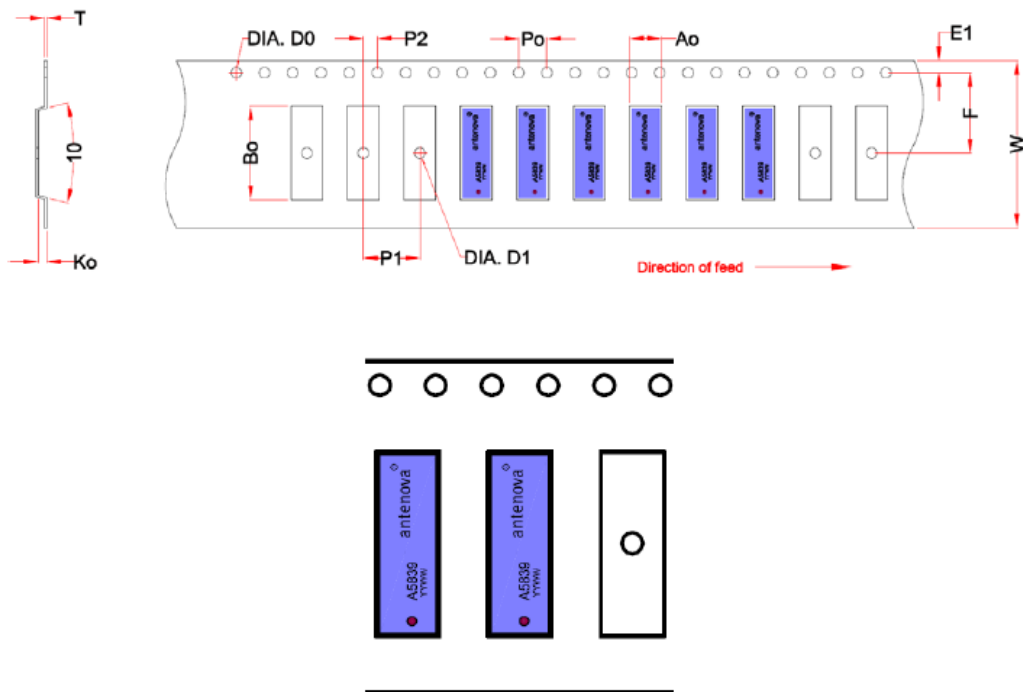

W	F	E1	P0	P1	P2	A0	B0	K0	T	D0	D1
24 ± 0.2	11.5 ± 0.1	1.75 ± 0.1	4 ± 0.1	8 ± 0.1	2 ± 0.1	4.3 ± 0.1	13.1 ± 0.1	1.4 ± 0.1	0.3 ± 0.05	Min 1.5	Min 1.5

Dimensions in mm

Quantity	Leading Space	Trailing Space
1000 pcs / reel	50 blank antenna holders	37 blank antenna holders

Antennas for Wireless M2M Applications



Rufa 2.4 GHz SMD Antenna  
Part No. A5839 / A5887

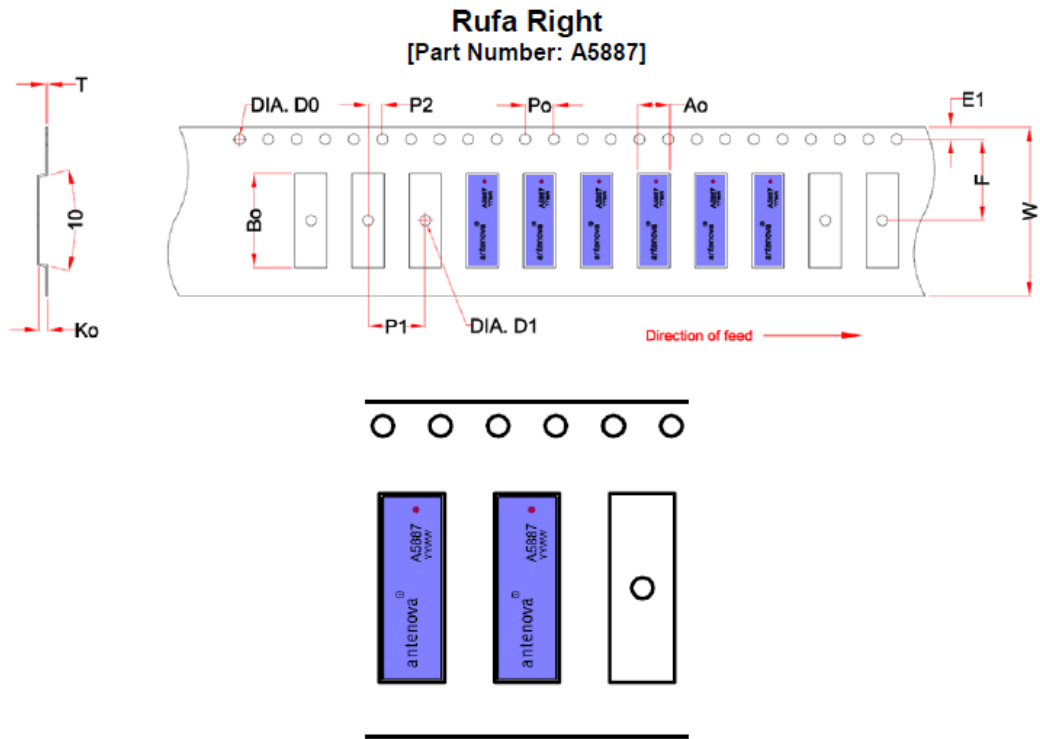

W	F	E1	P0	P1	P2	A0	B0	K0	T	D0	D1
24 ± 0.2	11.5 ± 0.1	1.75 ± 0.1	4 ± 0.1	8 ± 0.1	2 ± 0.1	4.3 ± 0.1	13.1 ± 0.1	1.4 ± 0.1	0.3 ± 0.05	Min 1.5	Min 1.5

Dimensions in mm

Quantity	Leading Space	Trailing Space
1000 pcs / reel	50 blank antenna holders	37 blank antenna holders

Antennas for Wireless M2M Applications

Rufa 2.4 GHz SMD Antenna  
Part No. A5839 / A5887

13-3 Reel dimensions

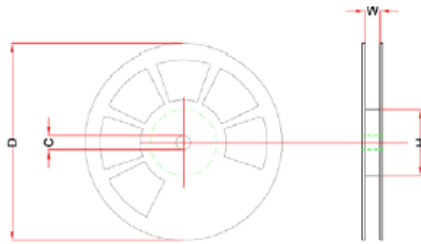

Width (W)	Reel Diameter (D)	Hub Diameter (H)	Shaft Diameter (C)
24 mm	180 mm (7")	60 mm (2")	13 mm

13-4 Box dimensions



Width (W)	Breadth (B)	Thickness (H)
203 mm	188 mm	40 mm

13-5 Bag properties

Reels are supplied in protective plastic packaging

13-6 Reel label information

Rufa Left

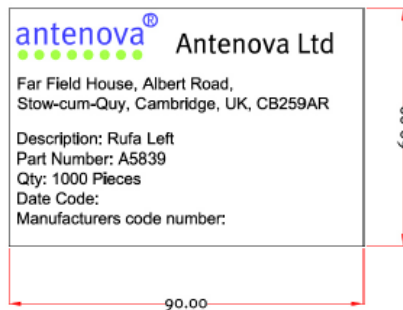

Rufa Right

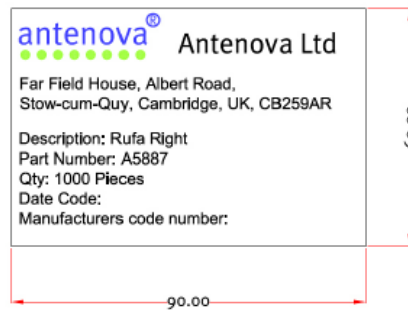

Dimensions in mm

Antennas for Wireless M2M Applications

Rufa 2.4 GHz SMD Antenna  
Part No. A5839 / A5887



**[www.antenova-m2m.com](http://www.antenova-m2m.com)**

**Corporate Headquarters**

Antenova Ltd.  
Far Field House  
Albert Road  
Stow-cum-Quy  
Cambridge  
CB25 9AR

**Tel:** +44 1223 810600  
**Fax:** +44 1223 810650  
**Email:** sales@antenova-m2m.com

**North America Headquarters**

Antenova Ltd.  
Rogers Business Park  
2541 Technology Drive Suite 403  
Elgin, IL 60124

**Tel:** +1 (847) 551 9710  
**Fax:** +1 (847) 551 9719  
**Email:** sales@antenova-m2m.com

**Asia Headquarters**

Antenova Asia Ltd.  
4F, No. 324, Sec. 1, Nei-Hu Road  
Nei-Hu District  
Taipei 11493  
Taiwan, ROC

**Tel:** +886 (0) 2 8797 8630  
**Fax:** +886 (0) 2 8797 6890  
**Email:** sales@antenova-m2m.com

**Copyright** © 2013 **Antenova Ltd.** All Rights Reserved. Antenova®, Antenova M2M, gigaNOVA®, and the Antenova and Antenova M2M logos are trademarks and/or registered trademarks of Antenova Ltd. Any other names and/or trademarks belong to their respective companies.

The materials provided herein are believed to be reliable and correct at the time of print. Antenova does not warrant the accuracy or completeness of the information, text, graphics or other items contained within these information. Antenova further assumes no responsibility for the use of this information, and all such information shall be entirely at the user's risk.



Certificate No: 4598

**Antennas for Wireless M2M Applications**

14

Product Specification AE020157-O  
Release Date 08 February 2013

## Product Specification



## BT-Stubby

2.4 GHz 1/4 Wave  
Stubby Antenna

### Features

- 1/4 Wave Stubby Antenna
- Straight SMA Connector
- Groundplane Dependent
- Ideal for fixed and mobile devices

### Specifications

Radiating element	1/4 Wave Helical
Frequency range	2.4 - 2.5 GHz
Peak gain	0 dBI
Polarisation	Linear
Return Loss	-14 dB
Impedance	50 Ohm
Cable / Connector	SMA-Male
Dimensions	33 x 8.3 mm (max)

### Ordering Options

FBTS35024-SM-ST	BT-Stubby with SMA-Male ST Connector
-----------------	--------------------------------------

Specifications subject to change without notice.

5 Little Balmer  
Buckingham Industrial Park  
Buckingham  
MK18 1TF  
UK

Tel: +44 (0)1280 824055  
Fax: +44 (0)1280 817179  
Email: sales@ead-ltd.com  
Web: www.ead-ltd.com

**EAD**   
embedded antenna design ltd  
*Delivering Antenna Innovation*

www.ead-ltd.com



## BT-Stubby | 2.4 GHz Stubby ST Antenna

### Return Loss

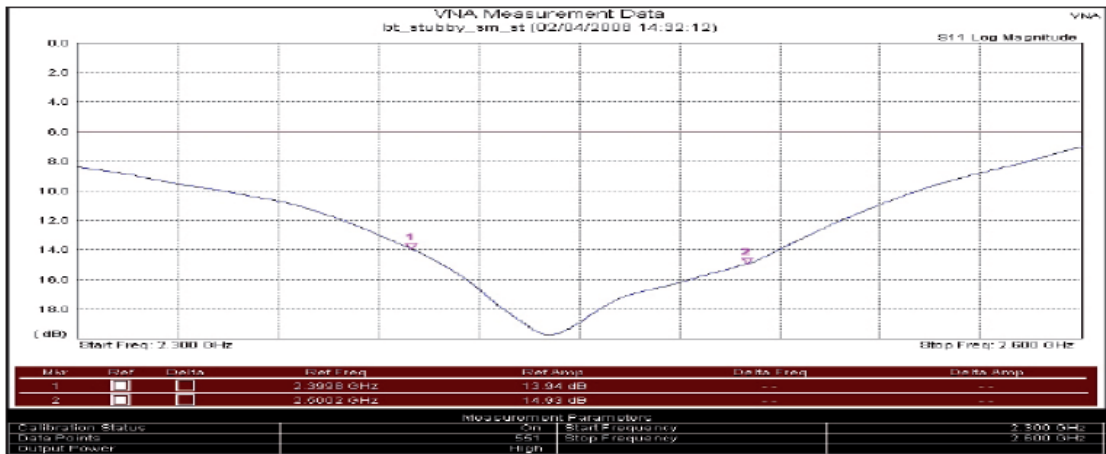

### Outline Drawing

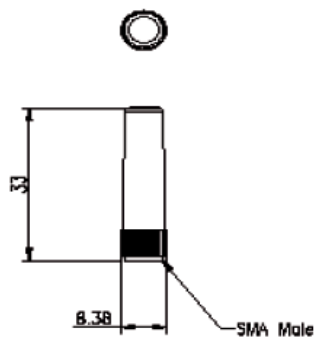

Specifications subject to change without notice.

5 Little Balmer  
Buckingham Industrial Park  
Buckingham  
MK18 1TF  
UK

Tel: +44 (0)1280 824055  
Fax: +44 (0)1280 817179  
Email: sales@ead-ltd.com  
Web: www.ead-ltd.com

**EAD**  
embedded antenna design ltd  
*Delivering Antenna Innovation*

# 倍增器天线 AP Antenna

单号:

型号 Model CJ-2400-6603

主要技术参数	Main Technical Specifications	
频率范围	Frequency	2400-2500MHz
驻波比	VSWR	≤1.5
增益	Gain ← <b>Peak Gain</b>	2.0 dBi
极化形式	Polarization Type	Vertical
最大功率	Rated power	50w
输入阻抗	Input Impedance	50 Ω
接口形式	Connector Type	SMA male
天线尺寸	Dimensions	Φ10X138 (mm)
重量	Weight	10.4g

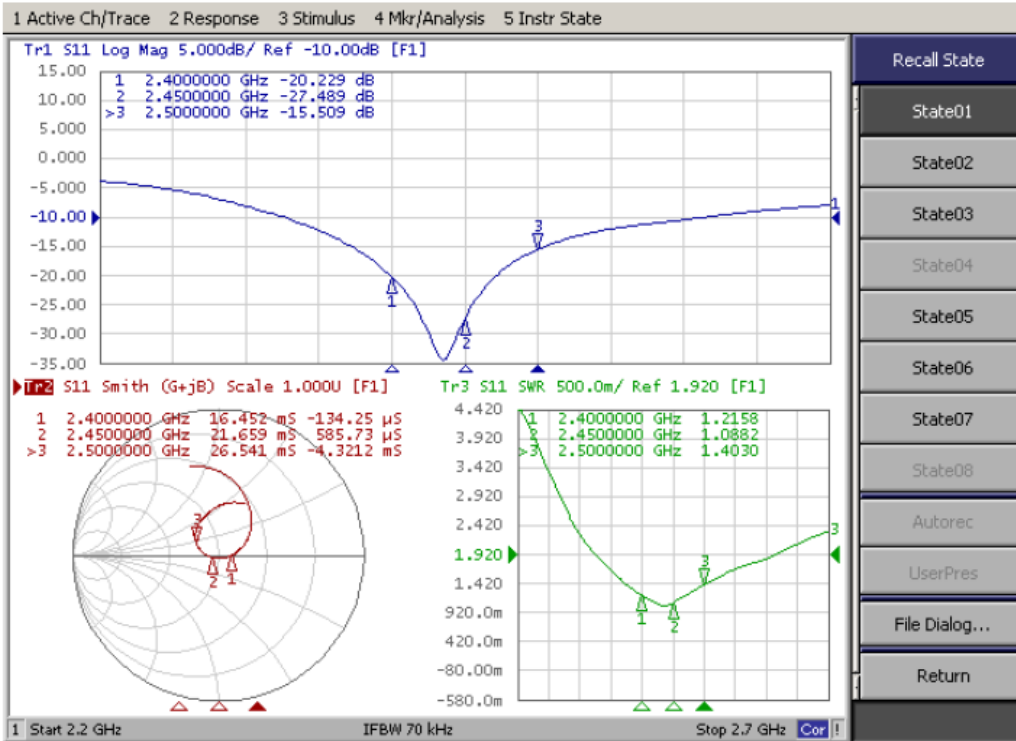

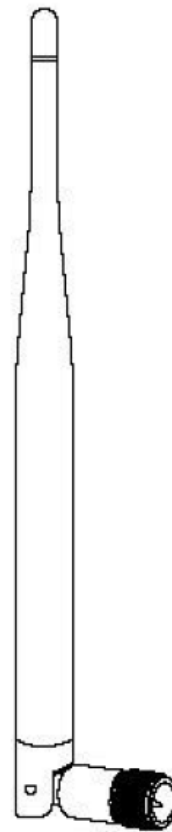
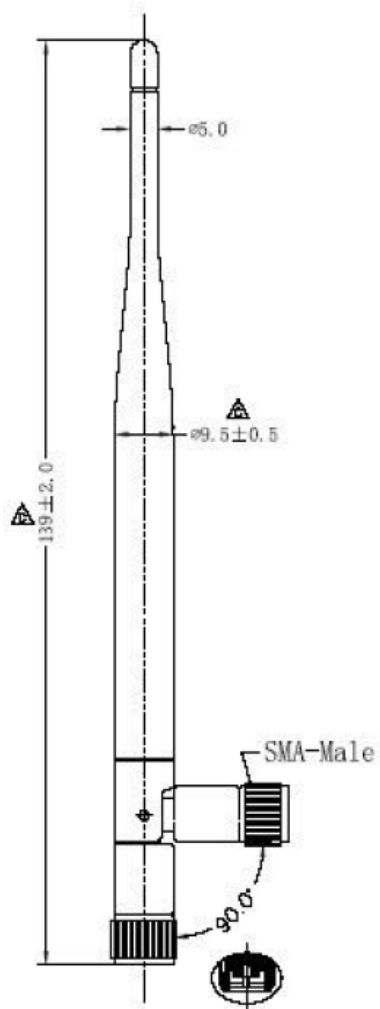

MECHANICAL

Antenna Cover:PU

Antenna Base:PC UL94V-0

ELECTRICAL

FRQUENEY:2.4GHZ

Connector:SMA-Male

Color:Black

2400.000MHz E1

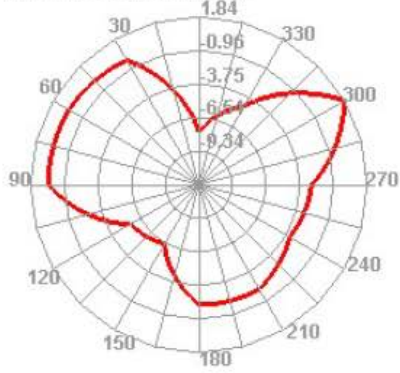

2400.000MHz E2

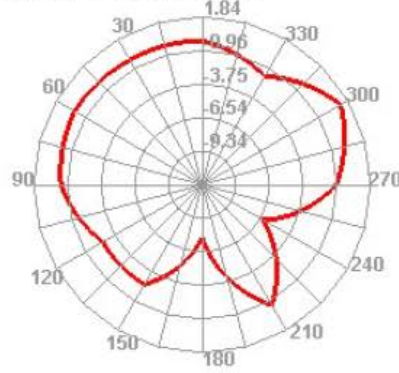

2450.000MHz

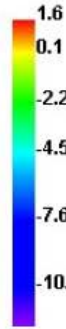
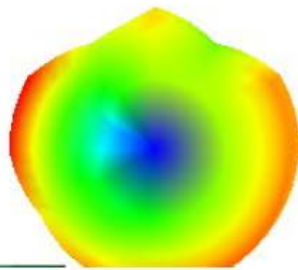

2450.000MHz H

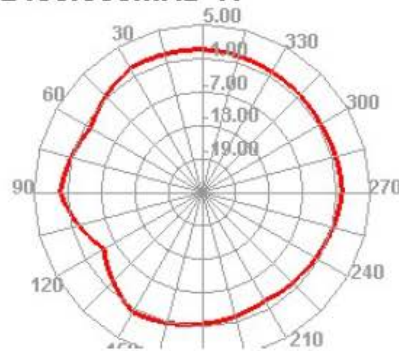

2500.000MHz

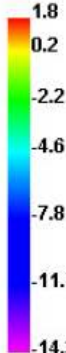
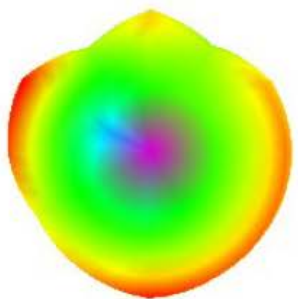

2500.000MHz H

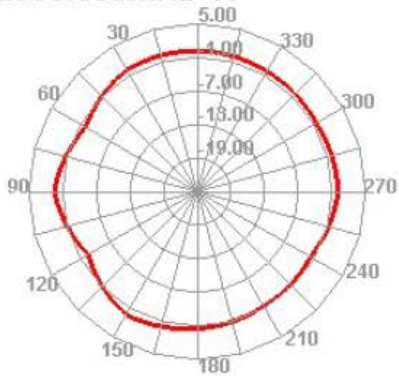



**Appendix E:**

**Photographs and Figures**

The following photographs are included to support this assessment:

1. Radiated test set-up Chip Antenna – Wide view
2. Radiated test set-up Chip Antenna – Close view
3. Radiated test set-up Quarter-wave Antenna – Wide view
4. Radiated test set-up Quarter-wave Antenna – Close view
5. Radiated test set-up Half-wave Antenna – Wide view
6. Radiated test set-up Half-wave Antenna – Close view



Photograph 1



Photograph 2



Photograph 3



Photograph 4



Photograph 5

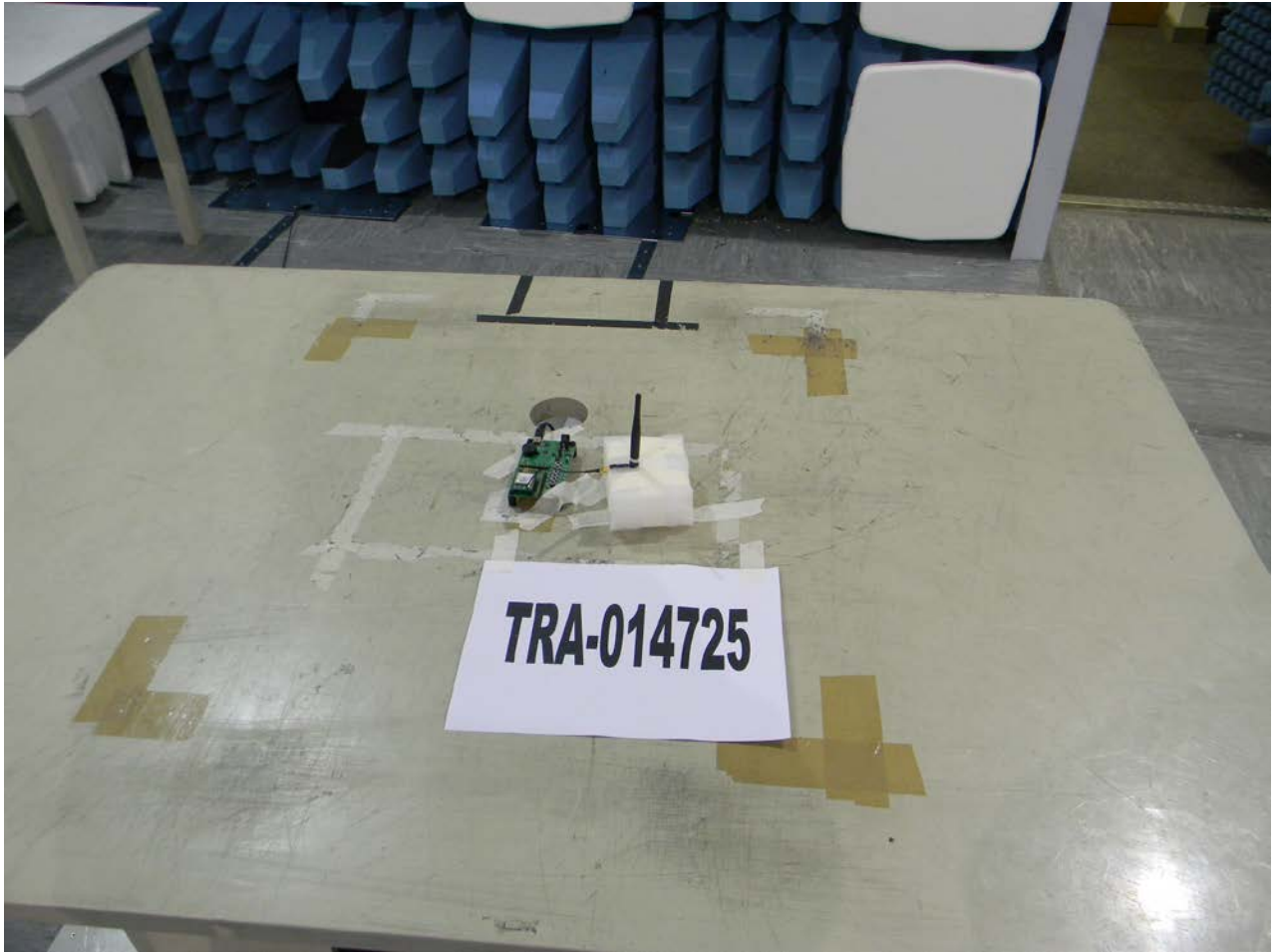

Photograph 6

**Appendix F:****MPE Calculation**

OET Bulletin No. 65, Supplement C 01-01

**47 CFR §§1.1307 and 2.1091**

2.1091 Radio frequency radiation exposure evaluation: mobile devices.

For purposes of these requirements mobile devices are defined by the FCC as transmitters designed to be used in other than fixed locations and to generally be used in such a way that a separation distance of at least 20 centimetres is normally maintained between radiating structures and the body of the user or nearby persons. These devices are normally evaluated for exposure potential with relation to the MPE limits. As the 20cm separation specified under FCC rules may not be achievable under normal operation of the EUT, an RF exposure calculation is needed to show the minimum distance required to be less than 1mW/cm<sup>2</sup> power density limit, as required under FCC rules.

**Prediction of MPE limit at a given distance**

Equation from page 18 of OET Bulletin 65, Edition 97-01

$$S = \frac{EIRP}{4\pi R^2} \text{ re - arranged } R = \sqrt{\frac{EIRP}{S4\pi}}$$

where:

S = power density

R = distance to the centre of radiation of the antenna

EIRP = EUT Maximum power

Note:

The EIRP measurement was performed using the peak conducted power measurement in conjunction with the maximum declared antenna gain.

Result

Prediction Frequency (MHz)	Maximum EIRP (mW)	Power density limit (S) (mW/cm <sup>2</sup> )	Distance (R) cm required to be less than 1mW/cm <sup>2</sup> (cm)
2445	157.04	1	3.54



**Appendix G:**

**IC Declaration**

**Supplement 1 to Test Report** : TRA-014725WUS2a

**Applicant** : Telegesis (UK)

**Apparatus** : ETRX358x-LRS & ETRX358xHR-LRS

**Specification(s)** : RSS-210 Issue 8 & RSS-Gen Issue 3

**IC ID** : 735A-EM358L

***The apparatus detailed above is compliant with the above standard as tested***

**Authorised by**



: Authorised Signatory

**Issue Date**

: 8<sup>th</sup> May 2014

**Authorised Copy Number**

: *PDF*

## Equipment description

The ETRX358x-LRS & ETRX358xHR-LRS testing was carried out to FCC 47CFR Part 15c and the results for this testing can be found in the TRaC test report: TRA-014725WUS2a.

All measurements were carried out in accordance with ANSI C63.10, 'American National Standard for Testing Unlicensed Wireless Devices.

## Standards Comparison

RSS-210 Annex 8 is the same as FCC 47CFR Part 15.247 for frequency and type of operation.

RSS-210 A8.2 (a) and Part 15.247(a)(2) both call for a minimum 6dB bandwidth of 500 kHz for digitally modulated equipment.

RSS-210 A8.2 (b) and Part 15.247(e) both call for a power spectral density of less than 8dBm in any 3 kHz bandwidth.

RSS-210 A8.4 (4) and Part 15.247(b)(3) both call for a conducted output power of 1 Watt or less.

RSS-210 A8.5 and Part 15.247(d) both call for measurements of spurious emissions in a 100 kHz measurement bandwidth. Any emission falling outside a restricted band must be 20dBc any emissions falling inside a restricted band must meet the general radiated limits.

RSS-210 2.2 (calling up RSS-GEN) and Part 15.247(d) both call for radiated spurious emissions in restricted bands to be measured with a 1MHz RBW and an average detector.

The general radiated limits of RSS-GEN 7.2.5 and Part 15.209 are the same.

RSS-GEN 7.2.4 and Part 15.207 are the same for AC Powerline conducted emissions.

RSS-GEN 6.1 and Part 15.109 have the same limits for receiver/unintentional emissions.

